

# Blue Brixx

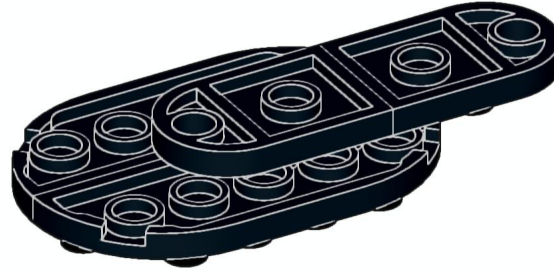

1

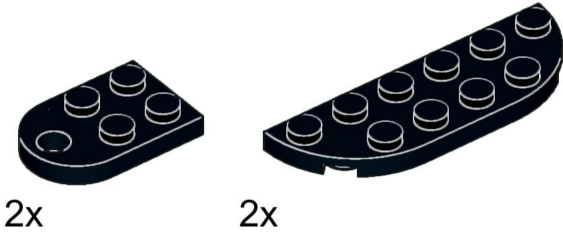

2

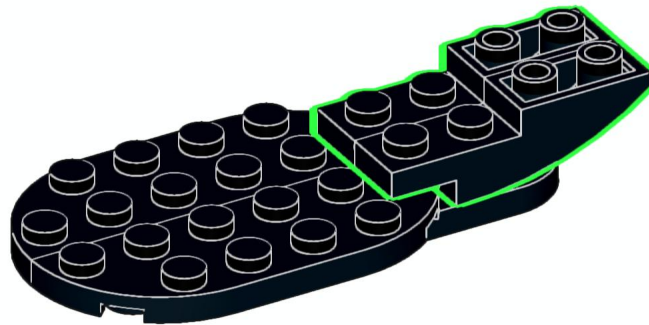
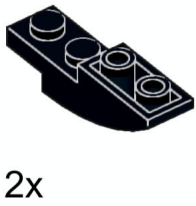

# 3

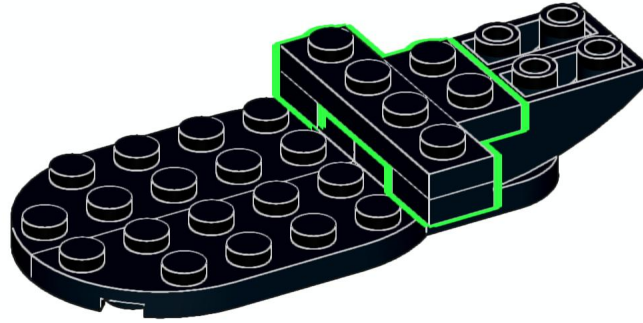
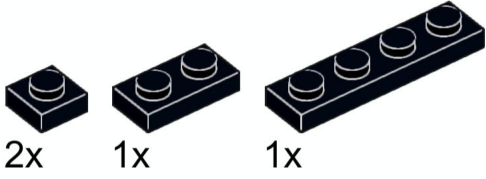

# 4

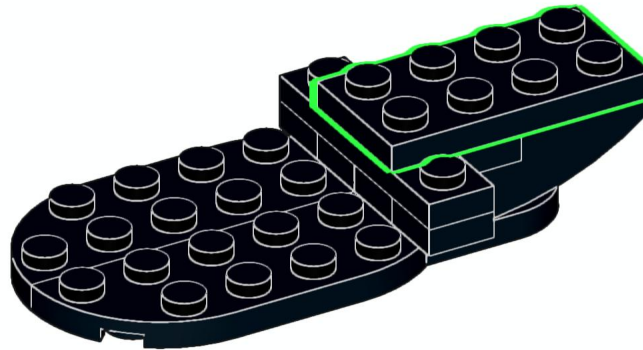

5



2x

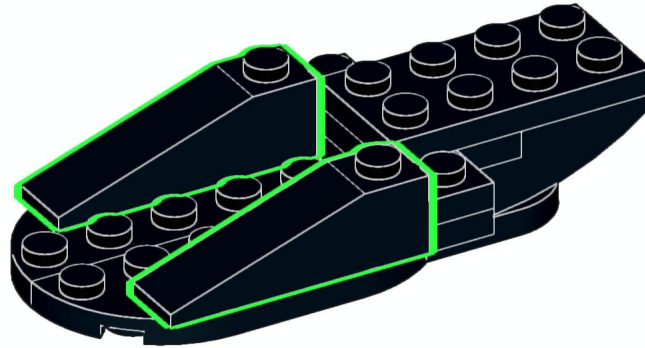

6



2x

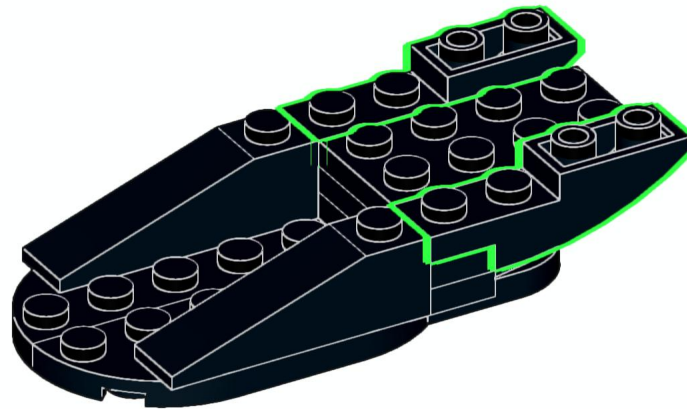

7



2x

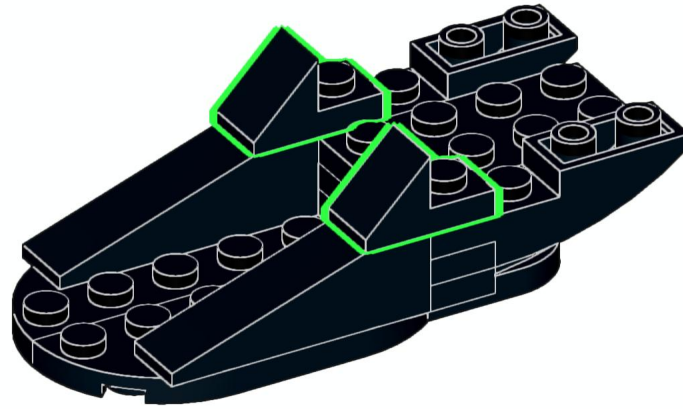

8



1x

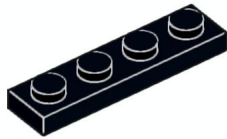

1x

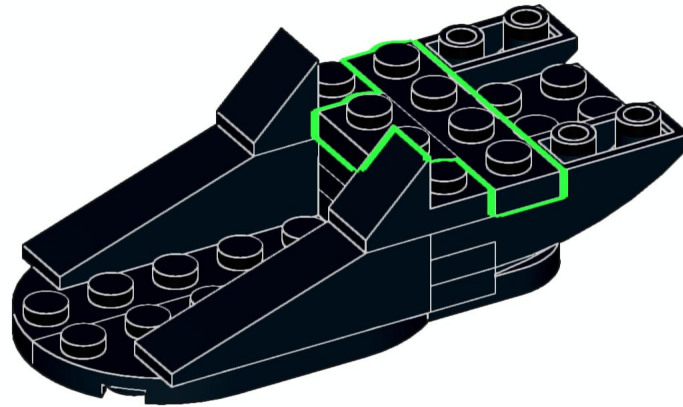

# 9

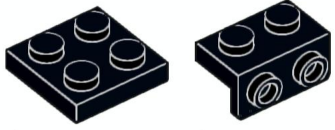

1x

1x

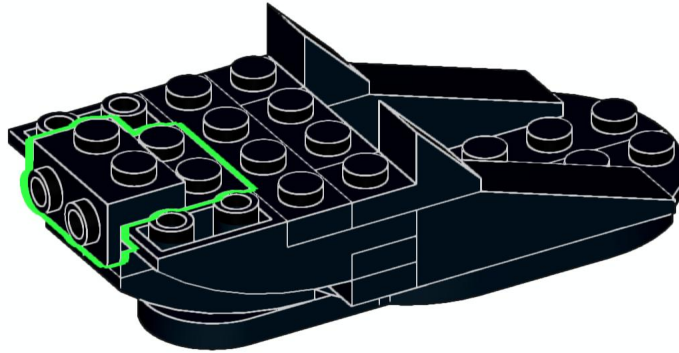

# 10



2x

1x

1x

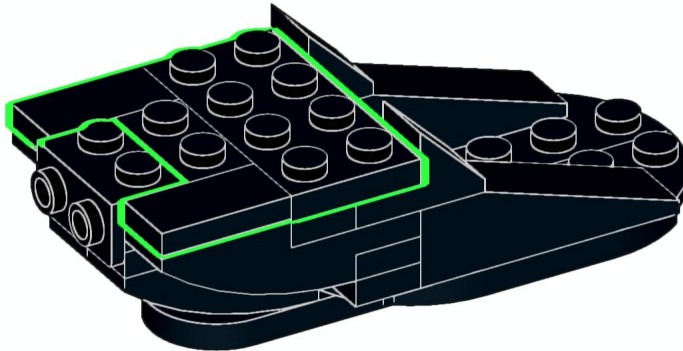

# 11



2x

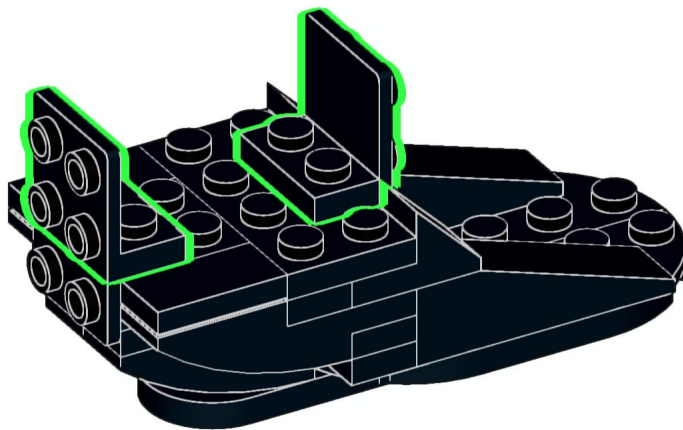

# 12



2x



2x



2x

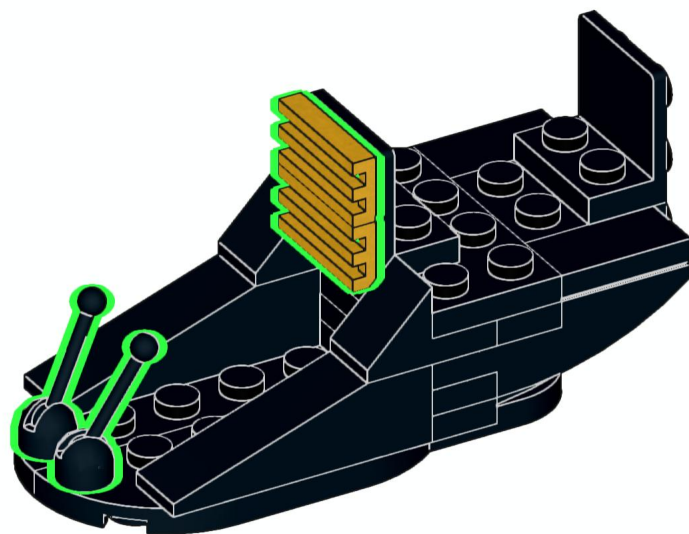

# 13

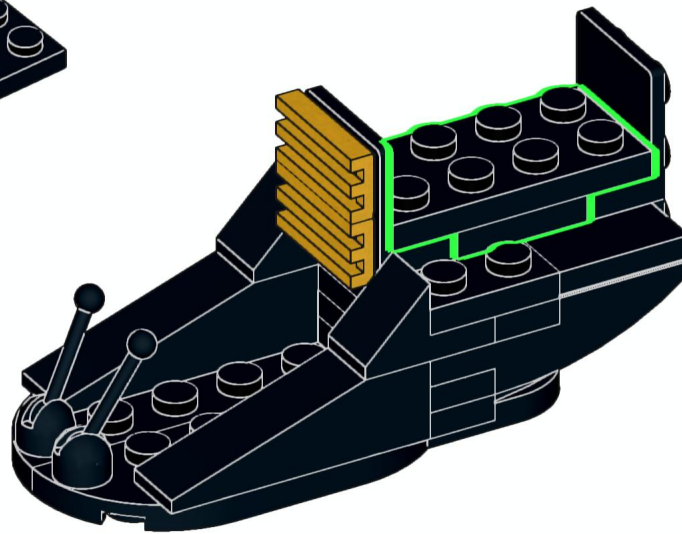
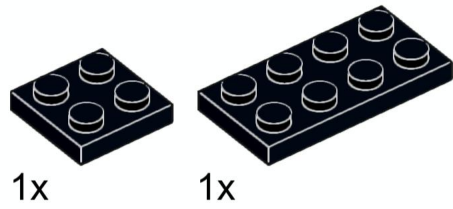

# 14

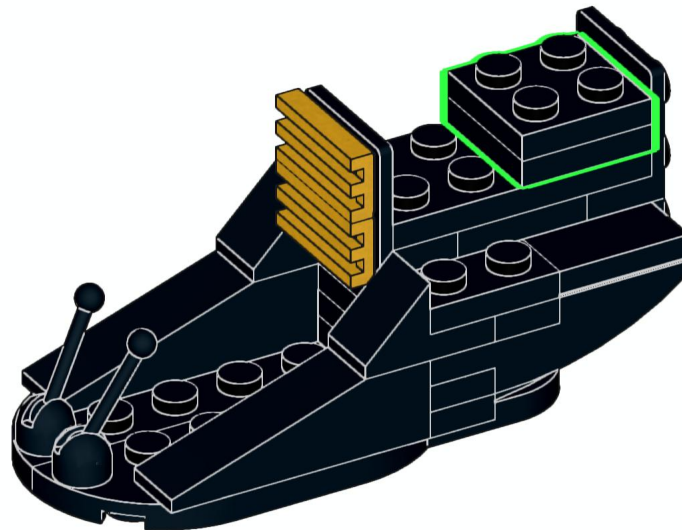



# 15

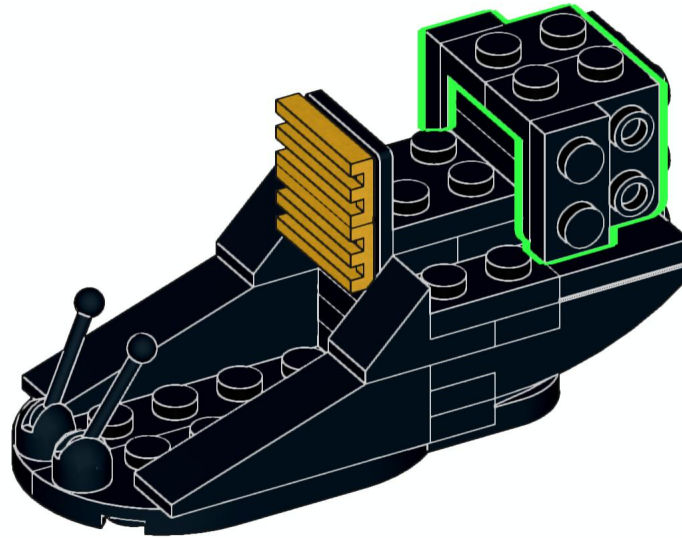
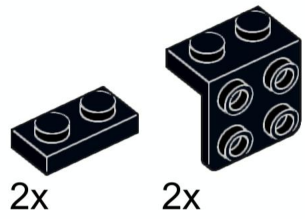

# 16

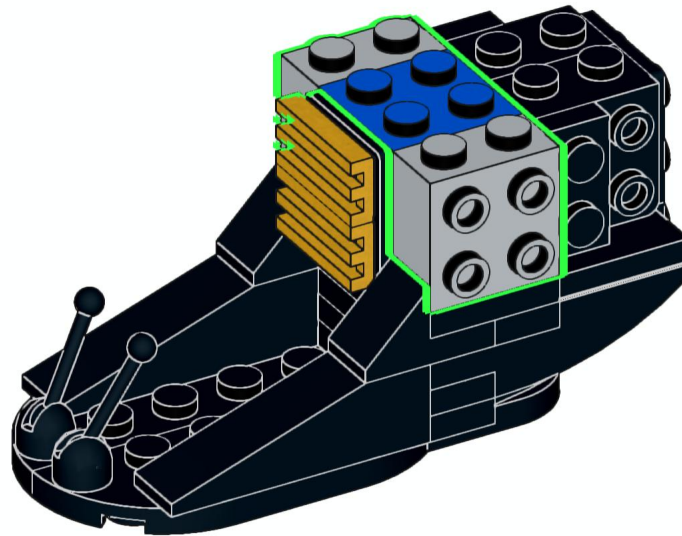
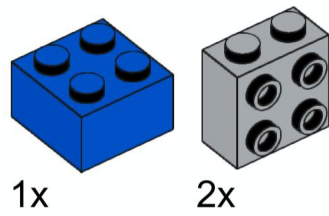

# 17

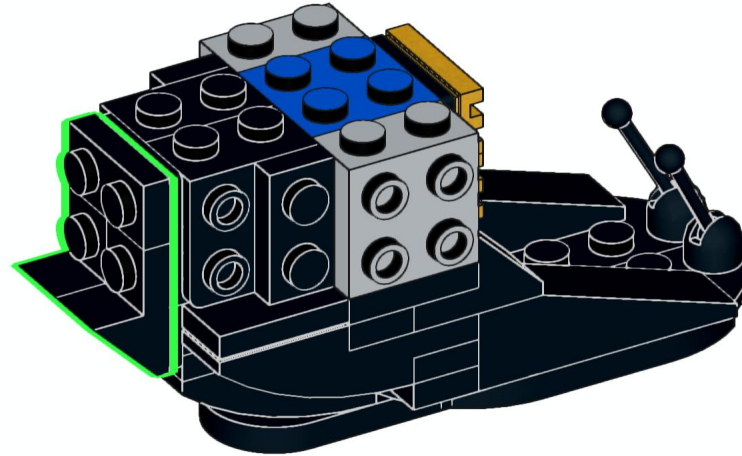
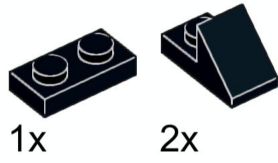

# 18

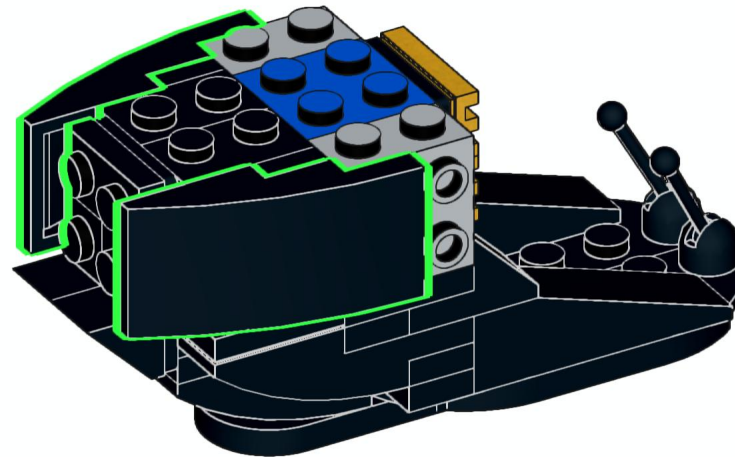

# 19

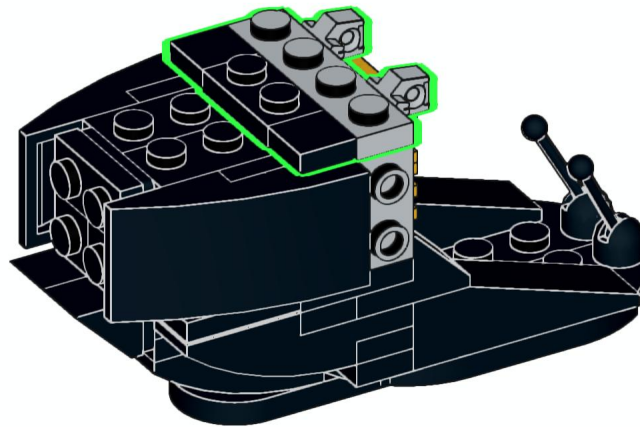
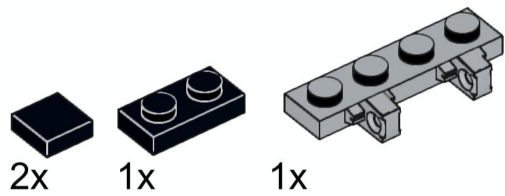

# 20

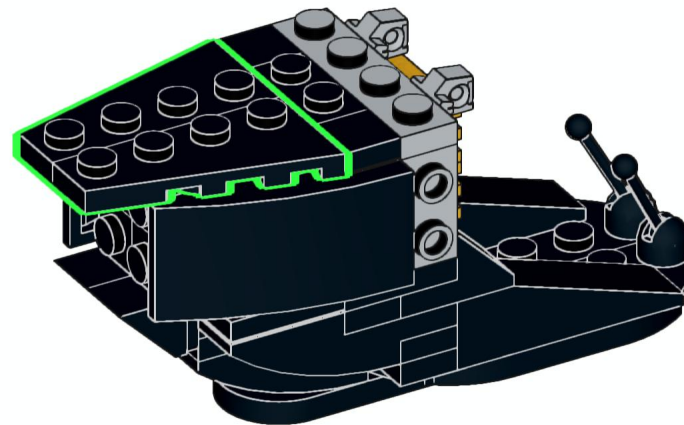
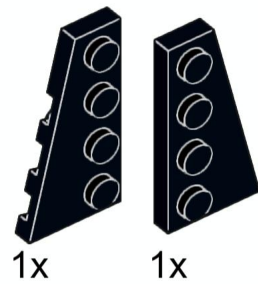

# 21

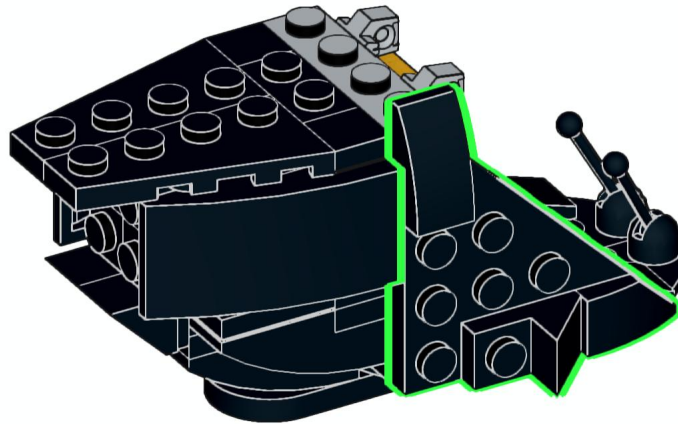
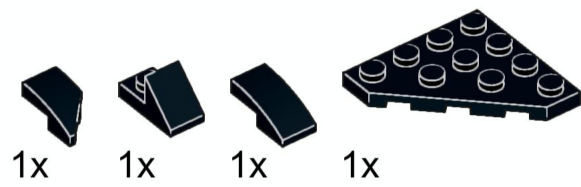

# 22

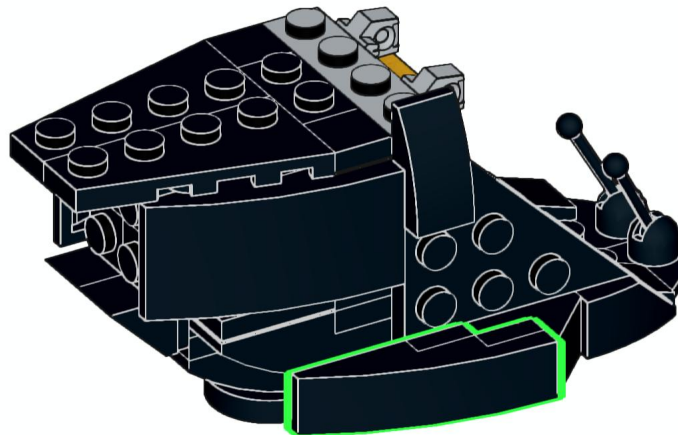
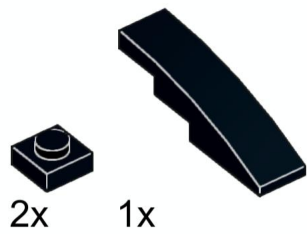

# 23

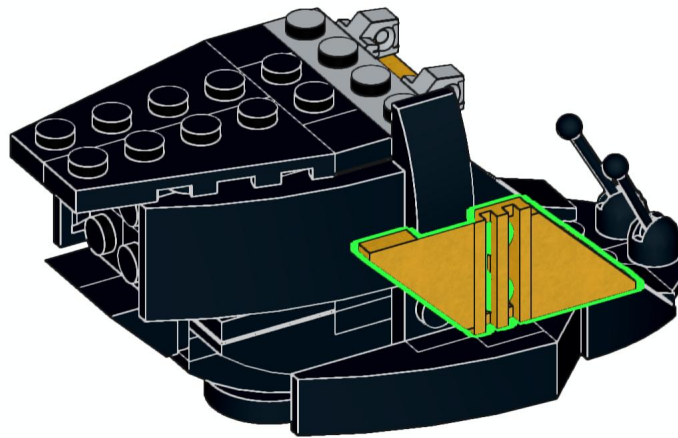
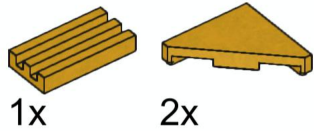

# 24

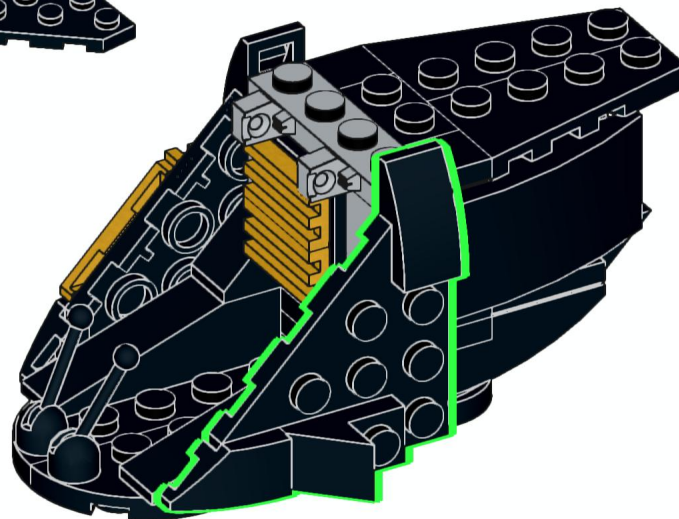
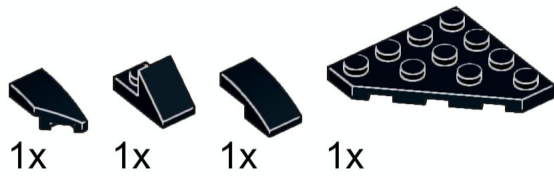

# 25



2x



1x

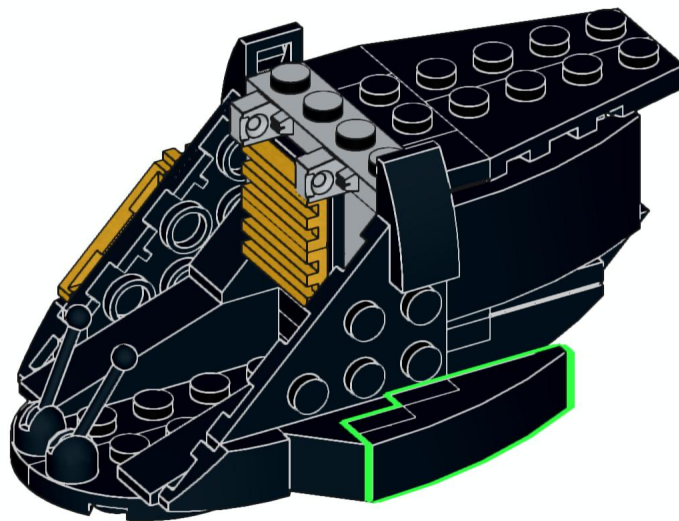

# 26



2x



1x

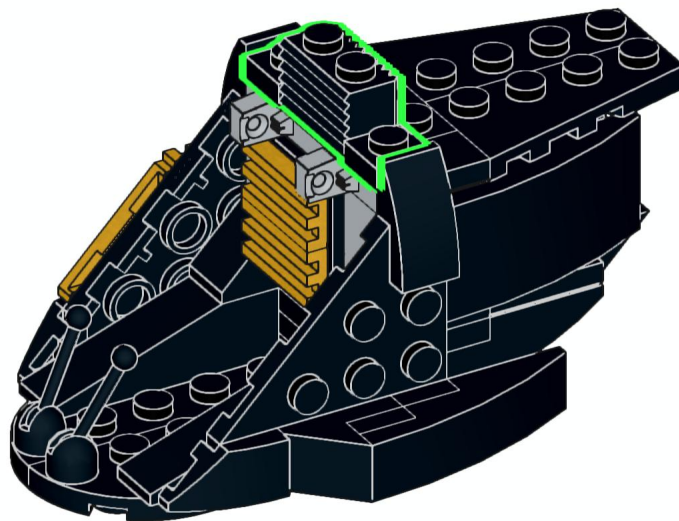

# 27

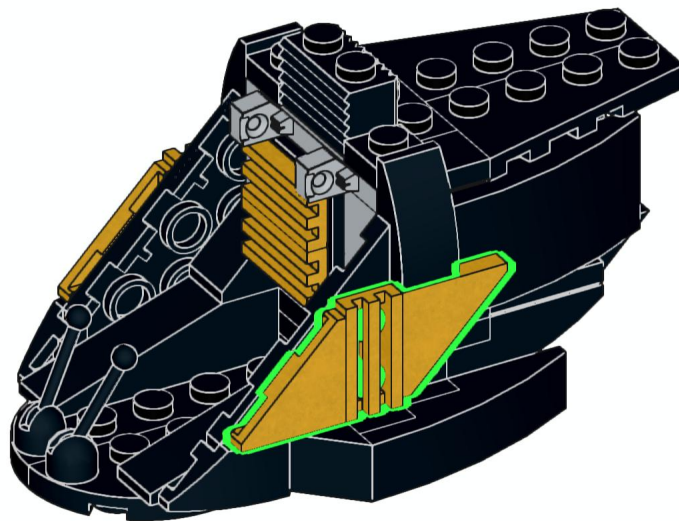
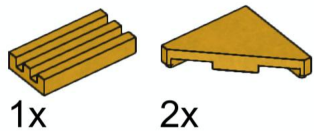

# 28

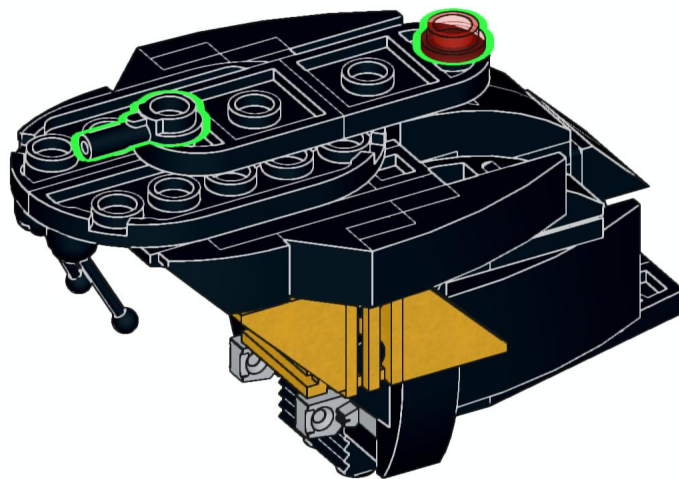
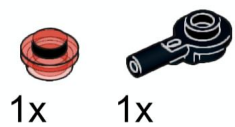

# 29



1x



2x



2x

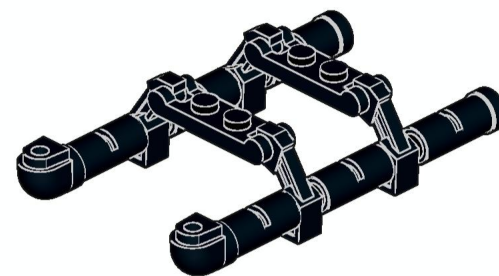
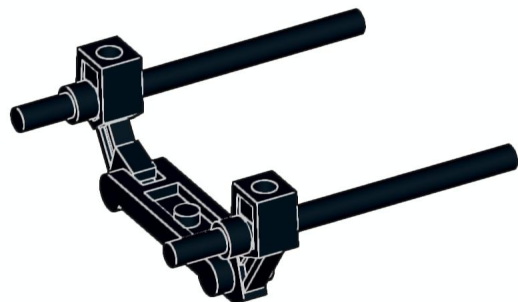

# 30



2x





# 31



2x

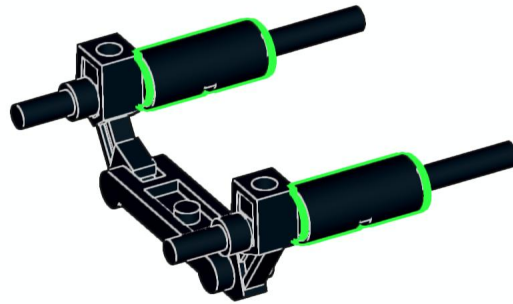

# 32



1x



2x

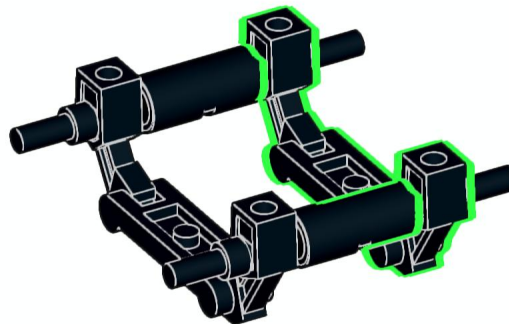

# 33

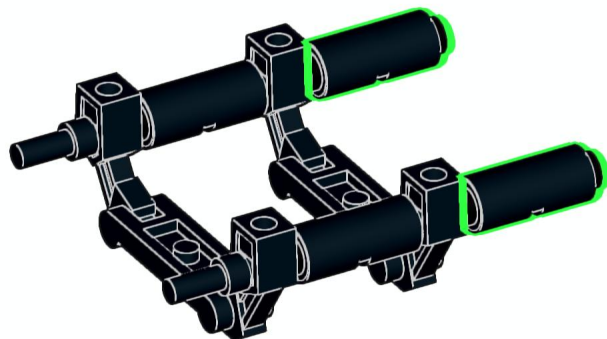

# 34

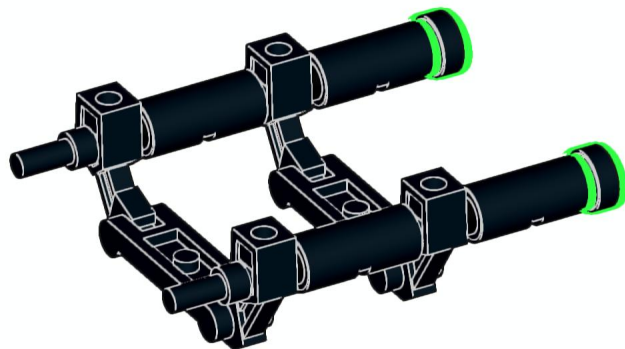

# 35

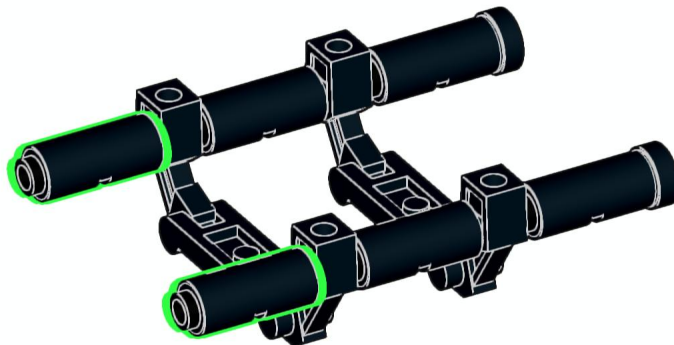

# 36

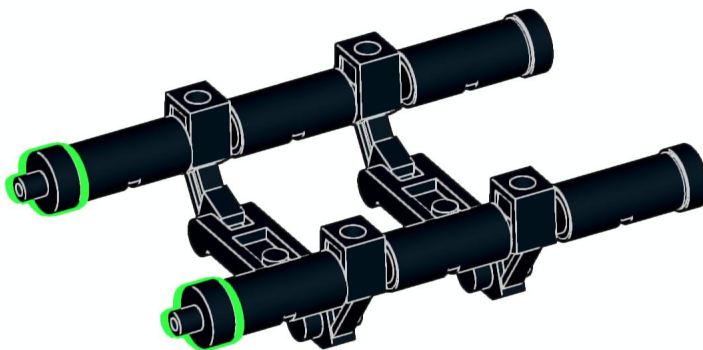

# 37



2x

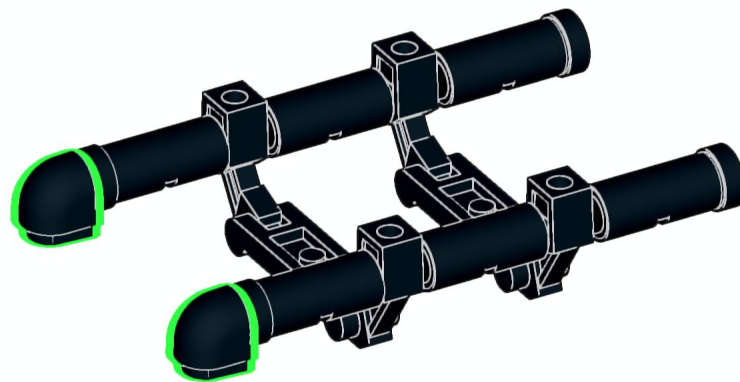

# 38

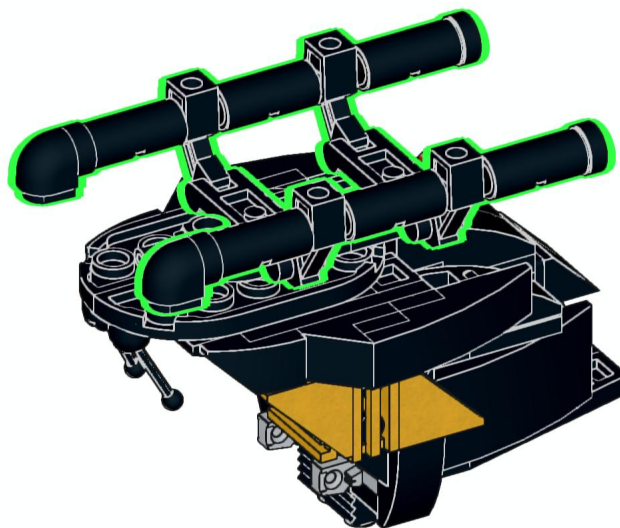

# 39

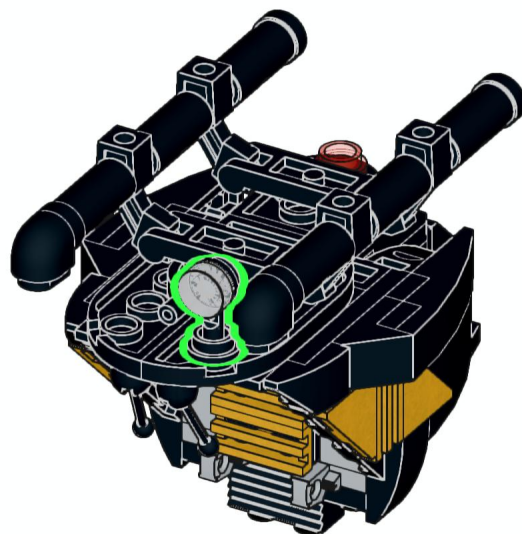
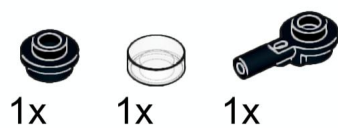

# 40



1x

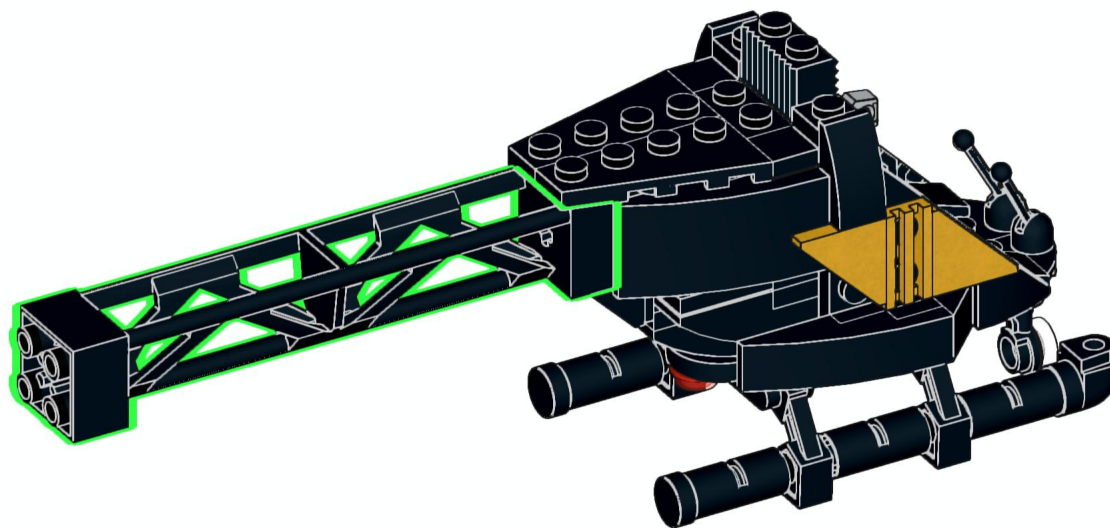

# 41

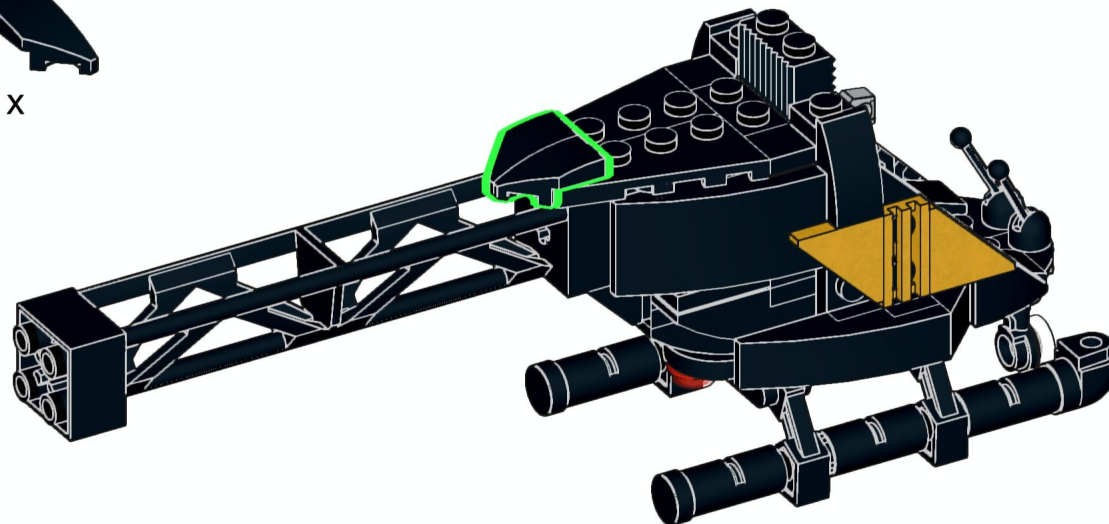
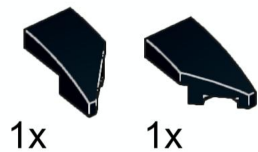

# 42

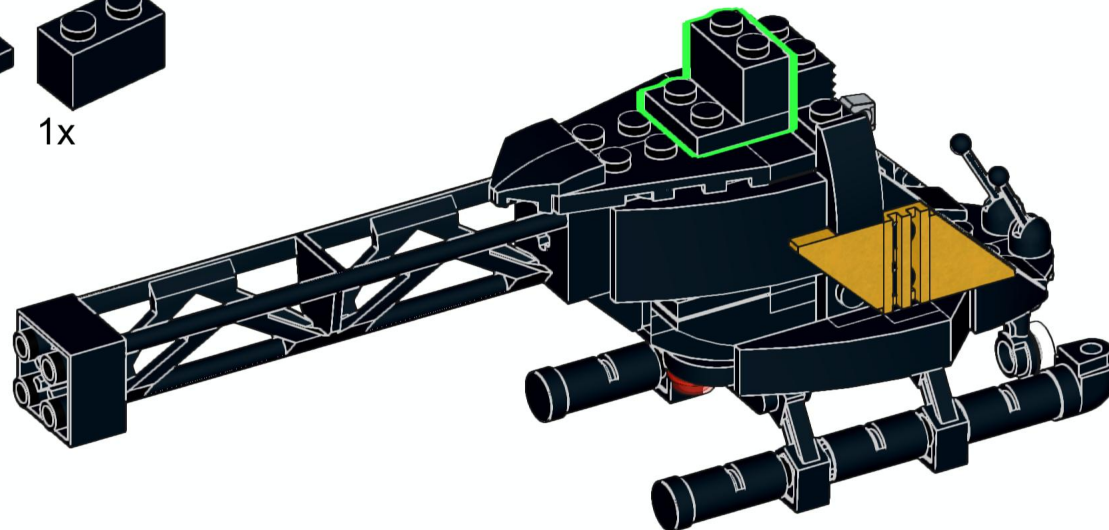
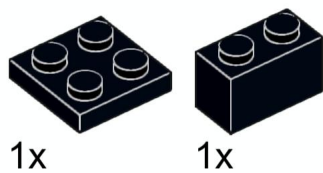

# 43



2x



2x

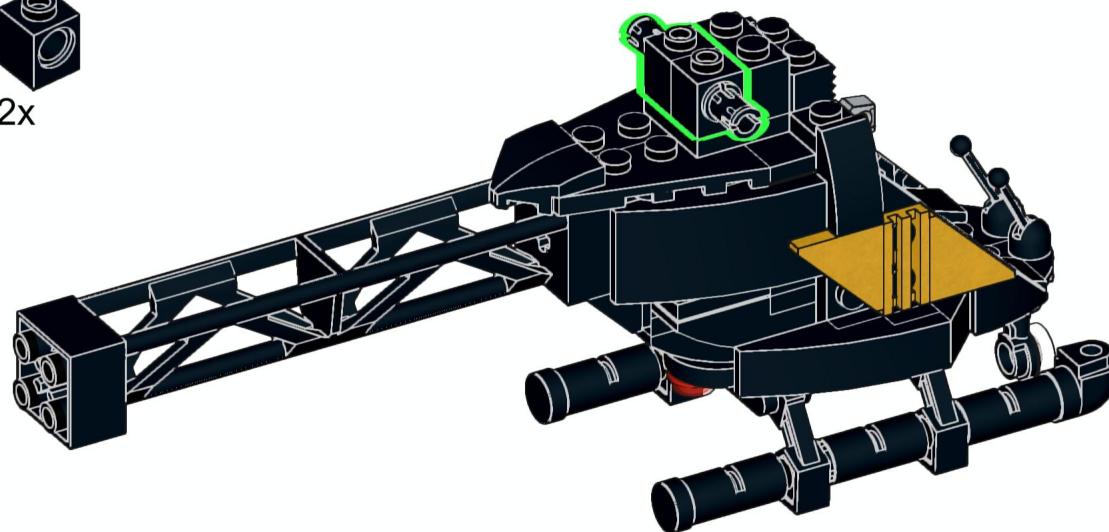

# 44



2x

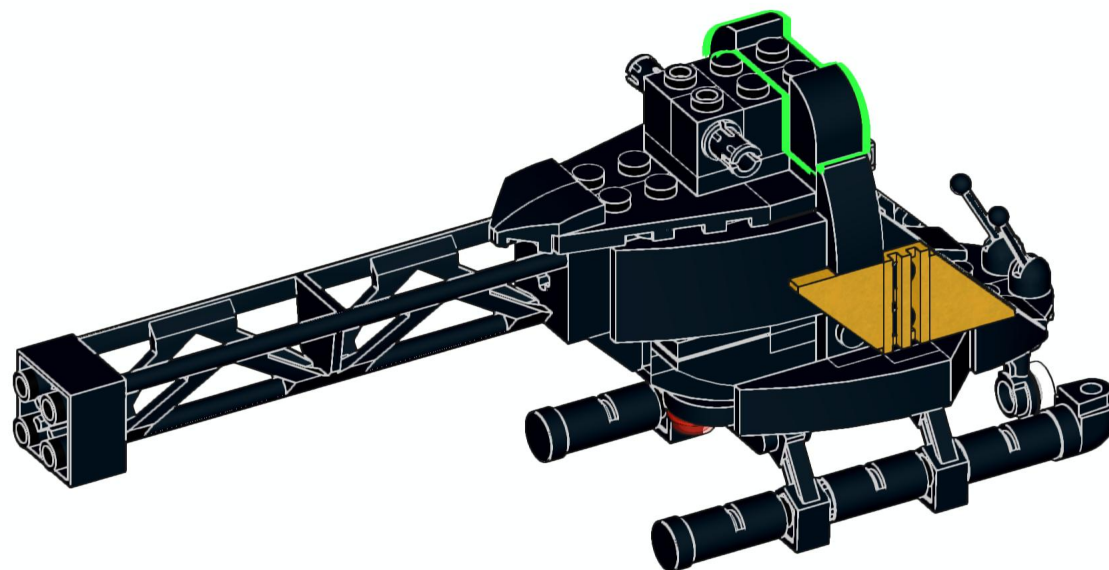

# 45

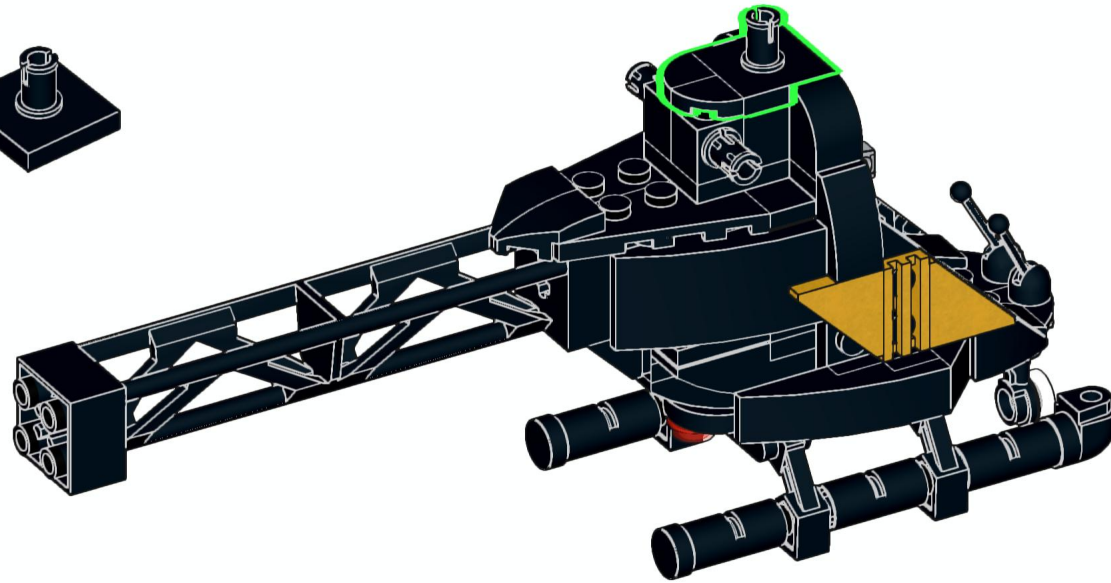
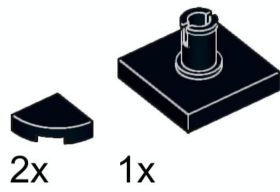

# 46

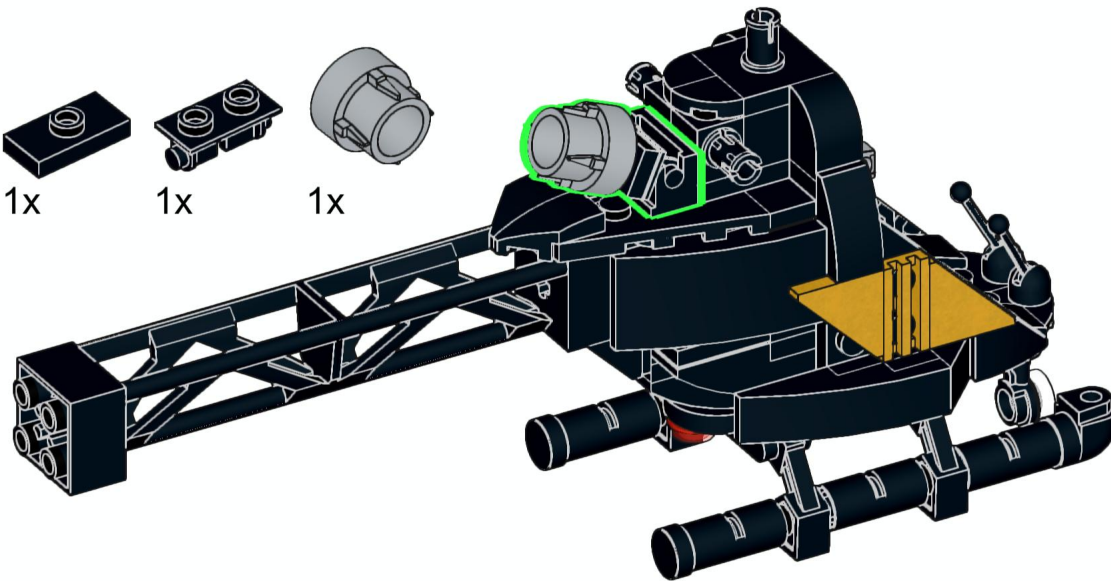
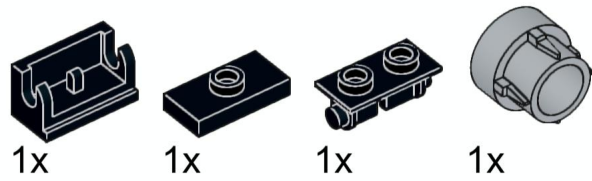



# 47

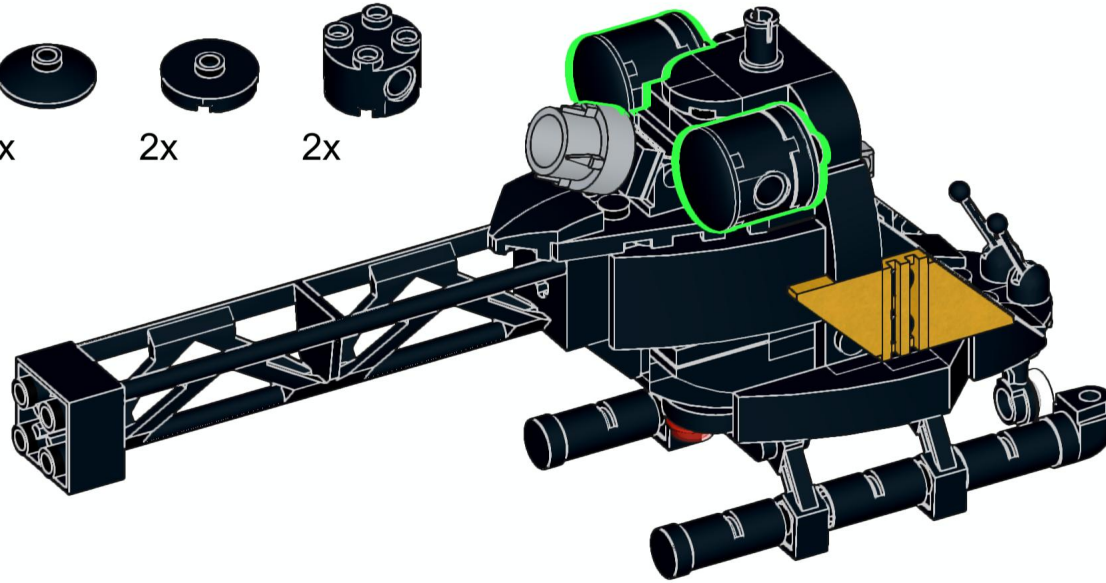

# 48

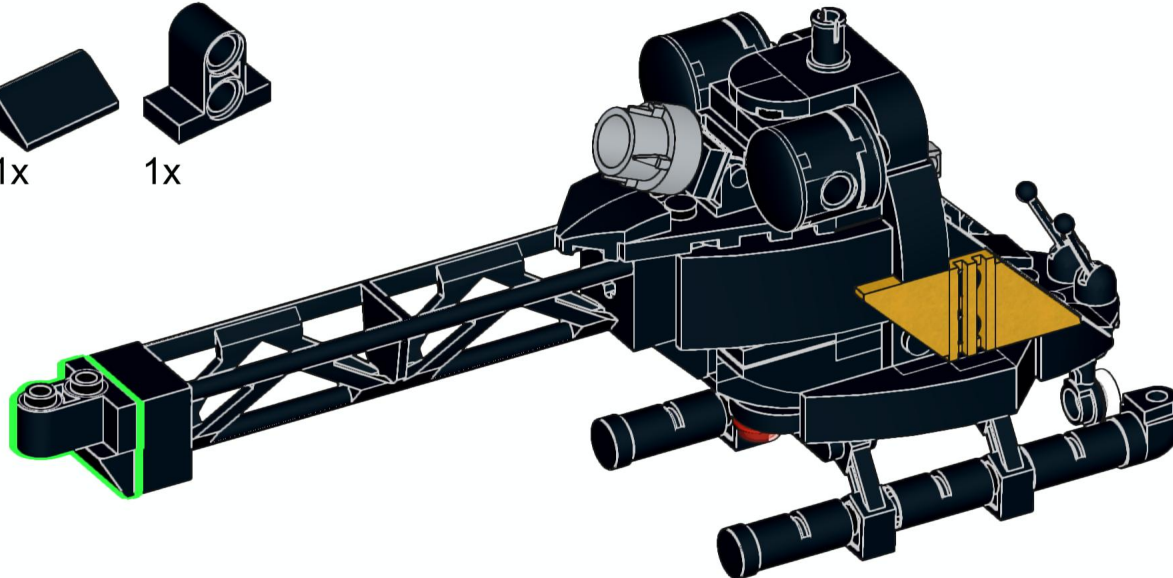
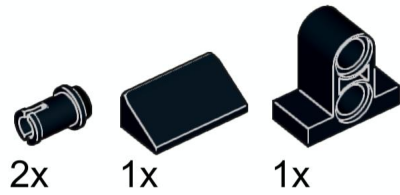

# 49

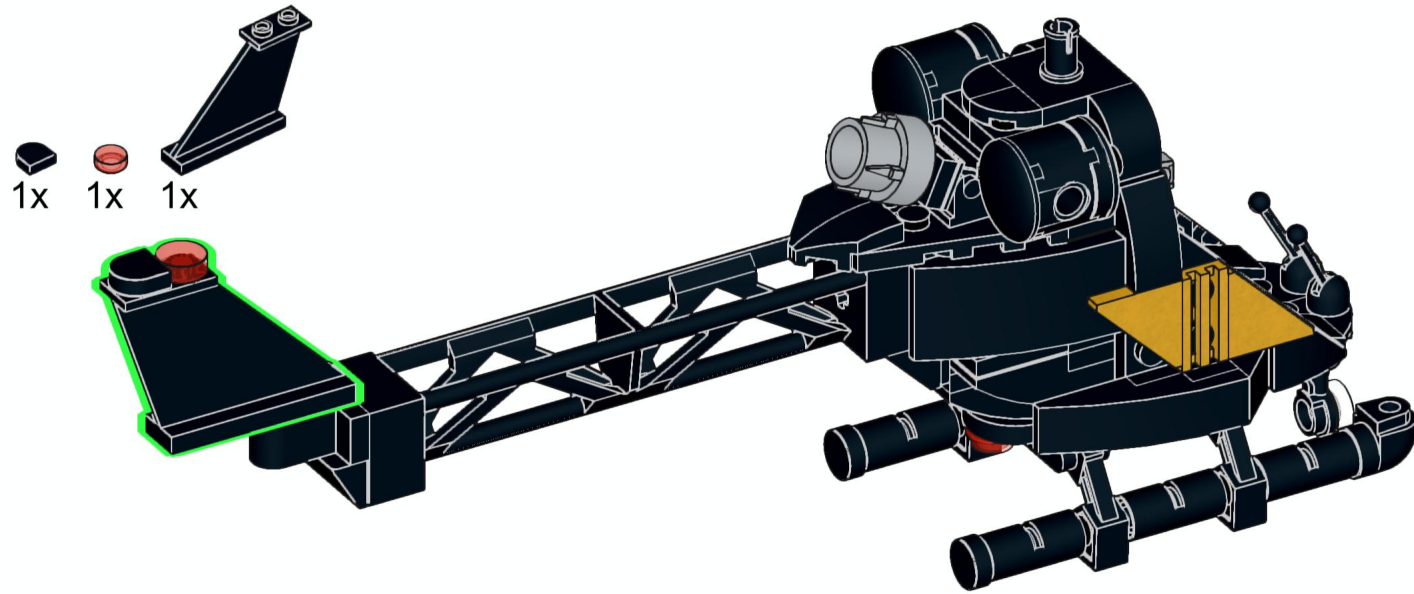

# 50

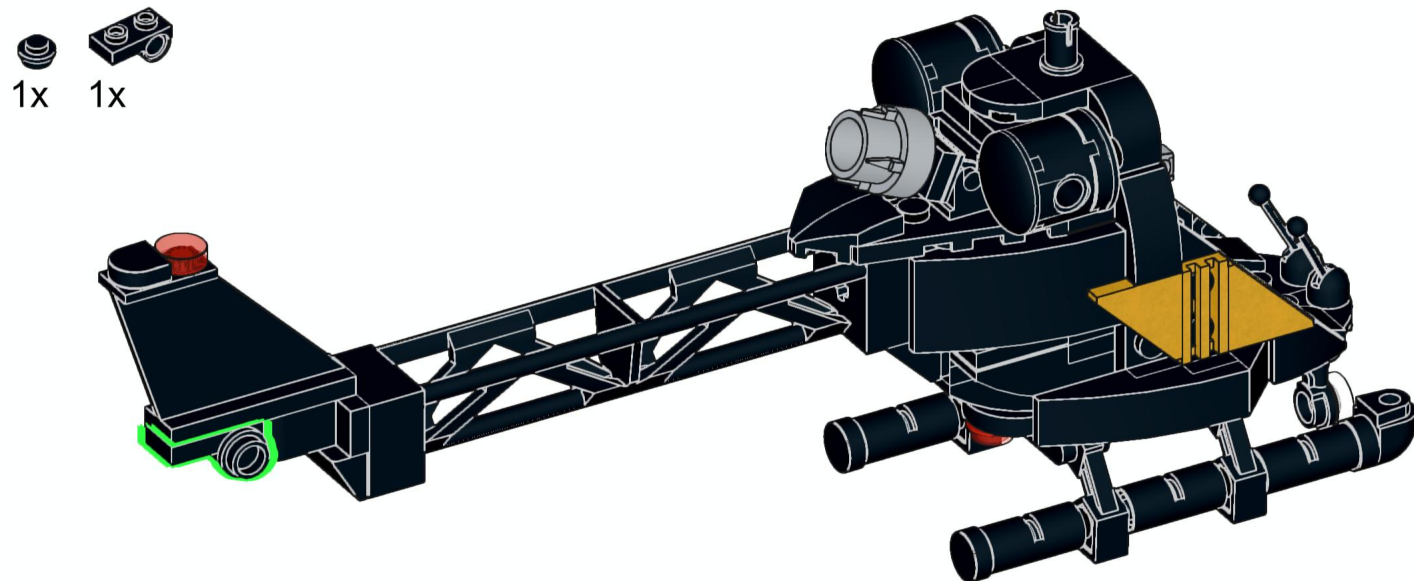

# 51

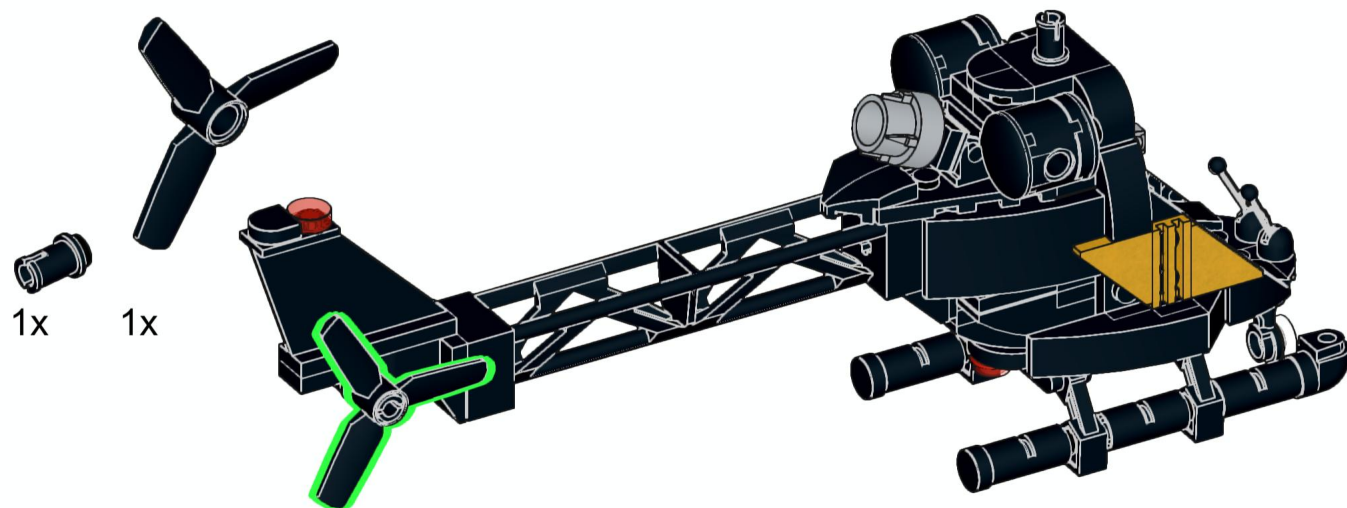

# 52

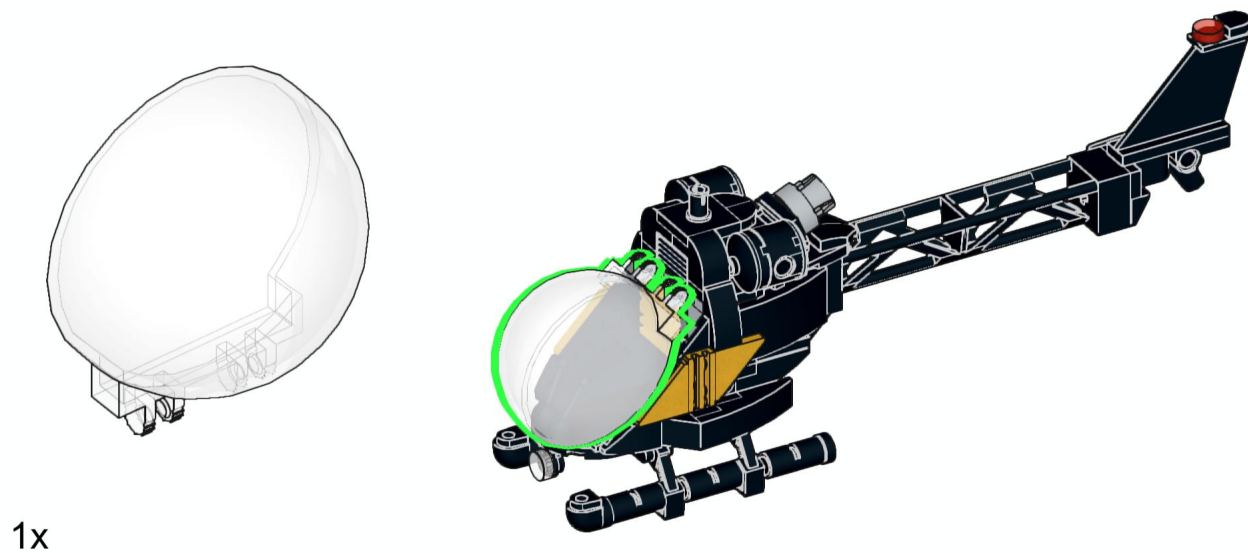

# 53



# 54

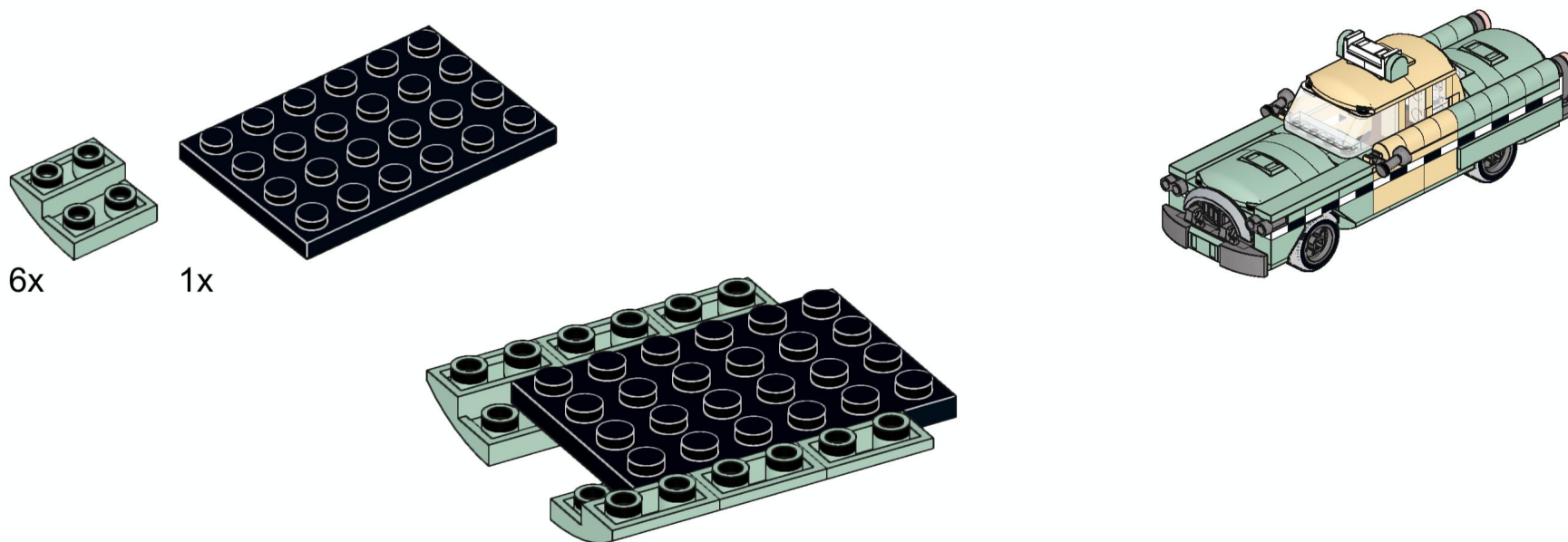

# 55

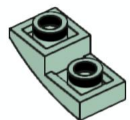

2x

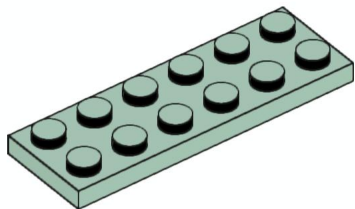

1x

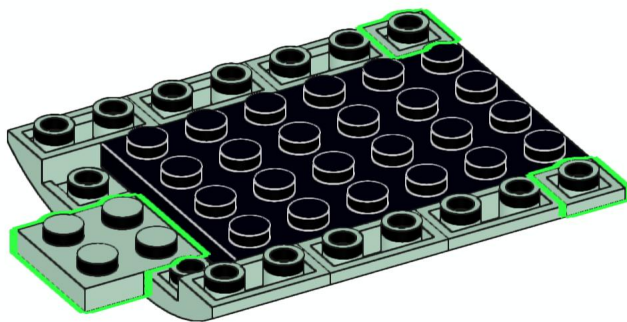

# 56



1x



1x

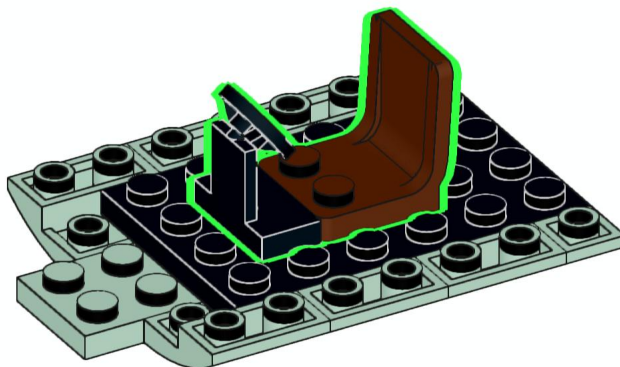

# 57

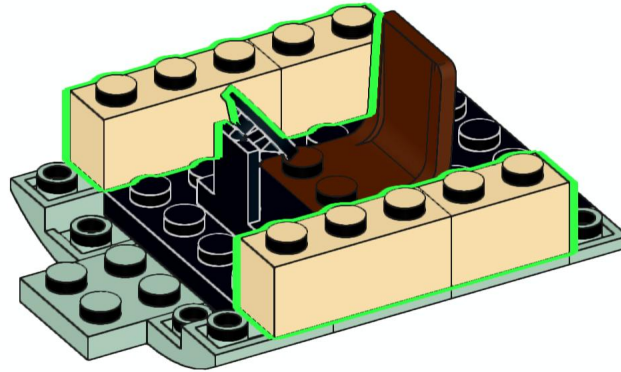
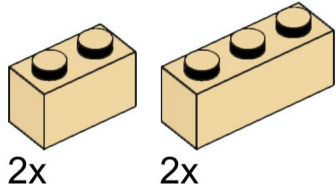

# 58

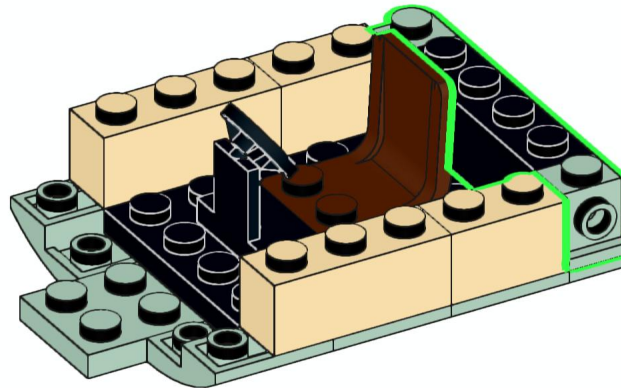
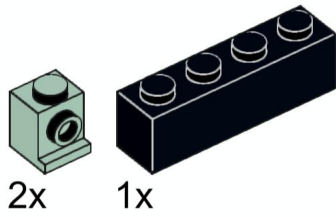

# 59



1x

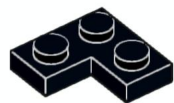

2x

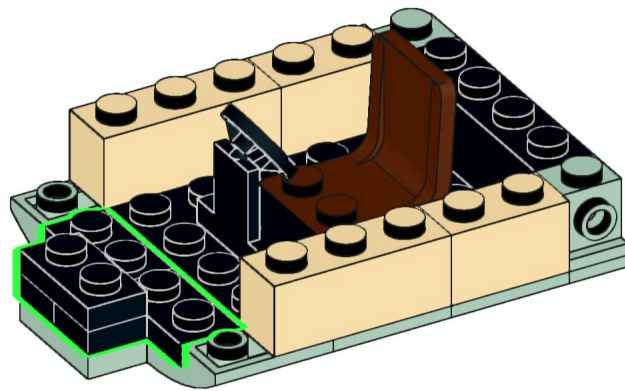

# 60

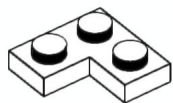

2x

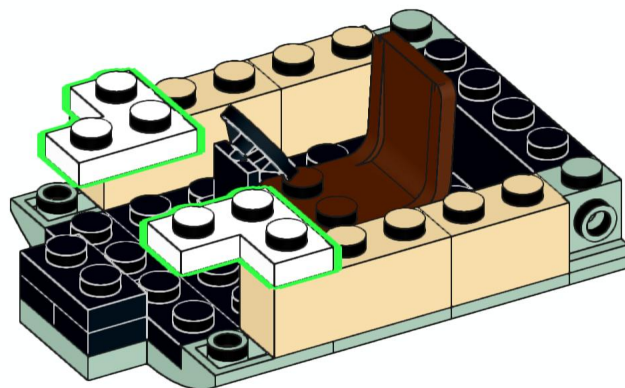

# 61

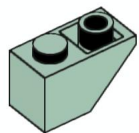

4x

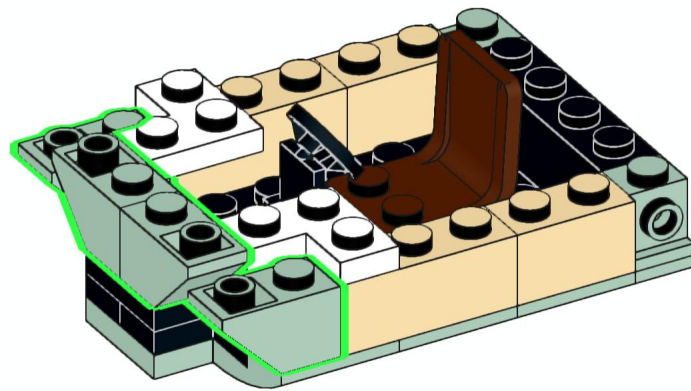

# 62



8x



6x

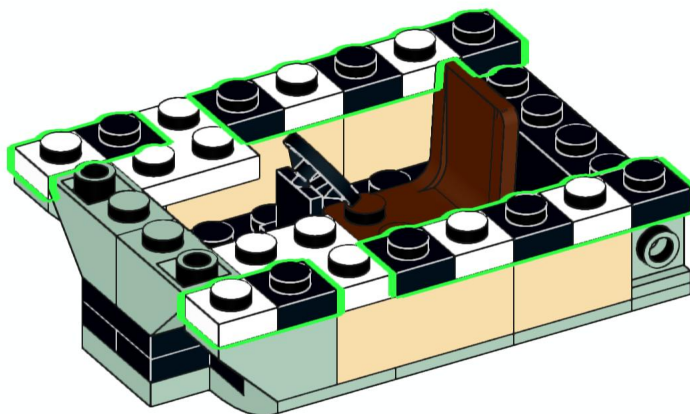



# 63

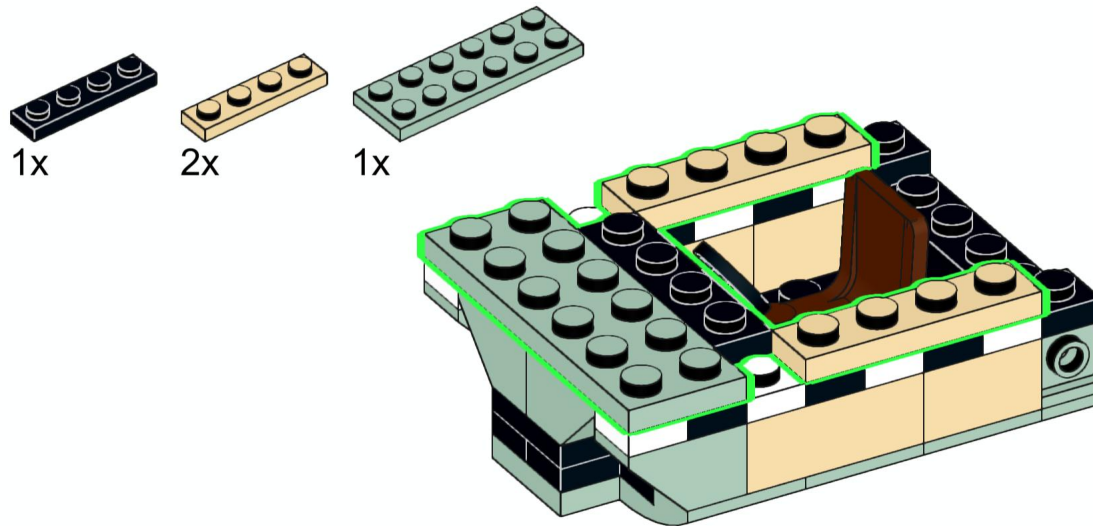

# 64

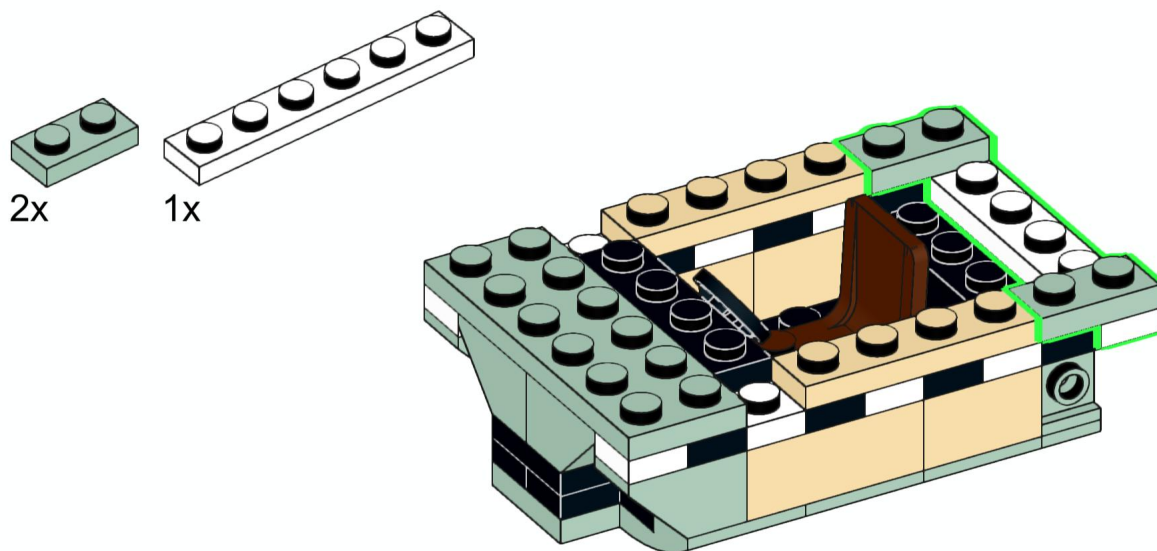

# 65

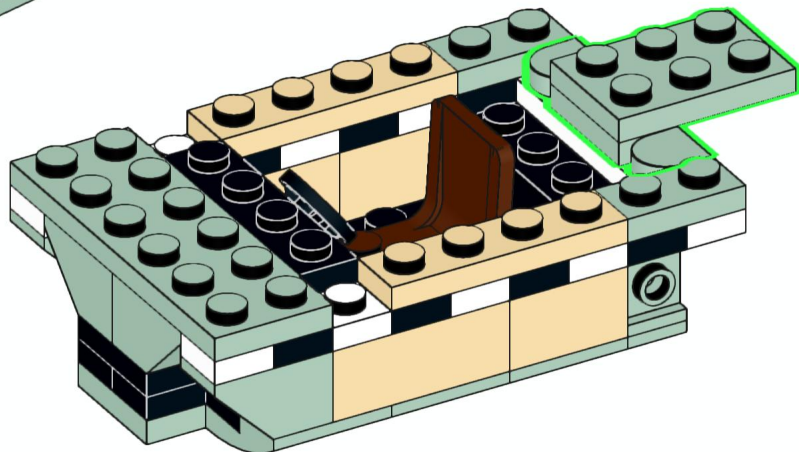
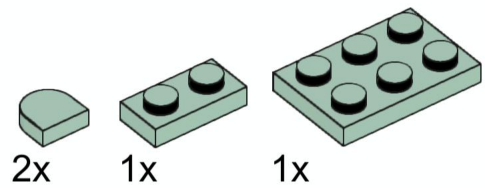

# 66

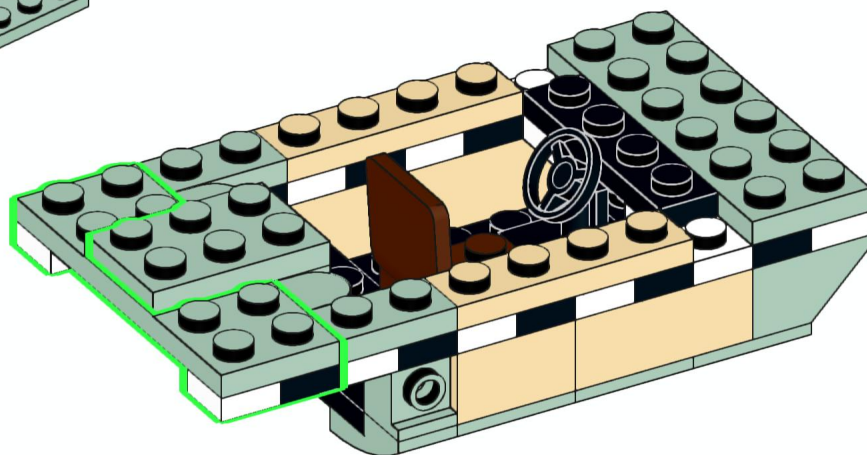
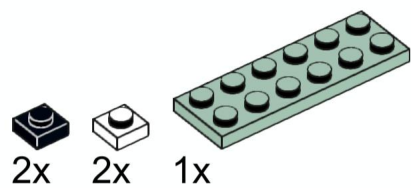

# 67

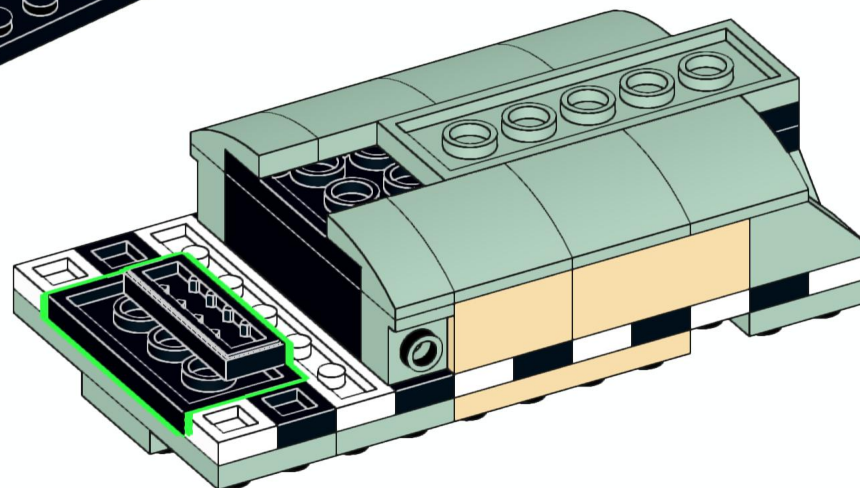
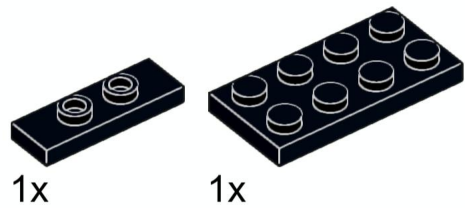

# 68

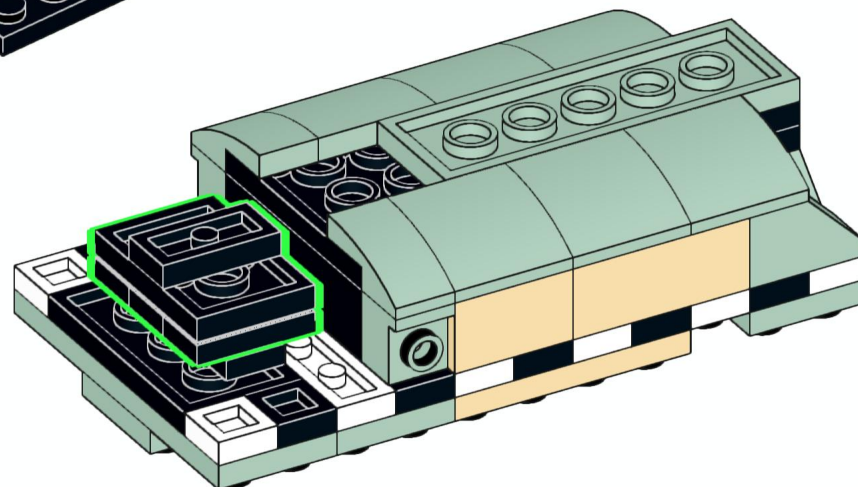
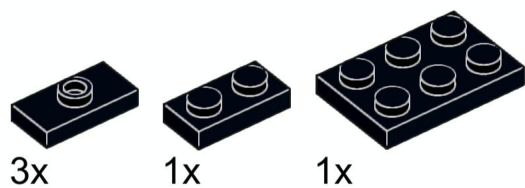

# 69

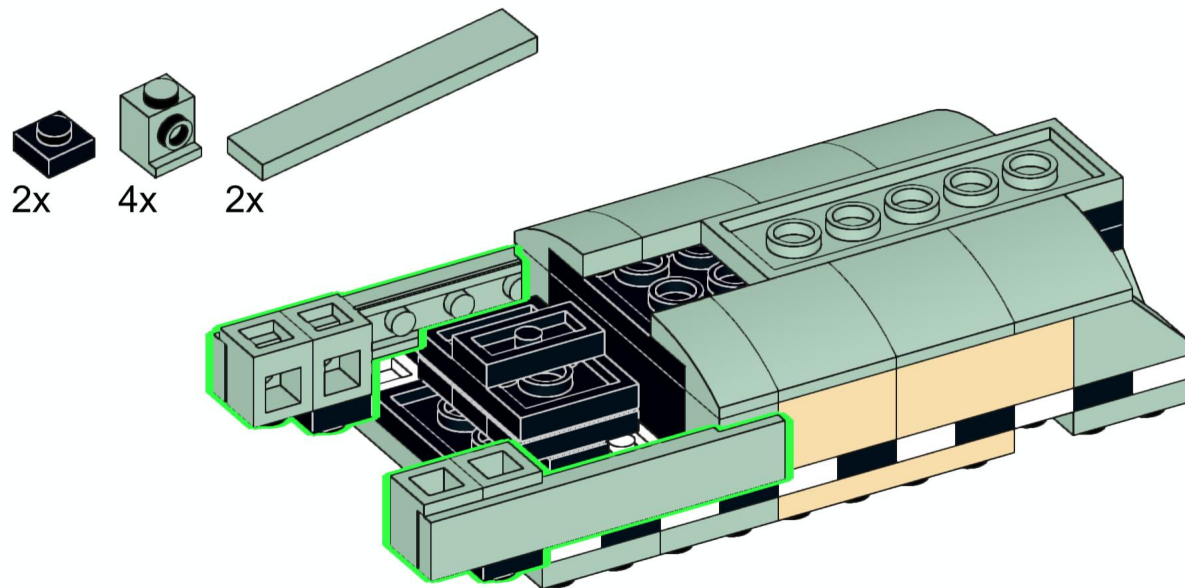

# 70

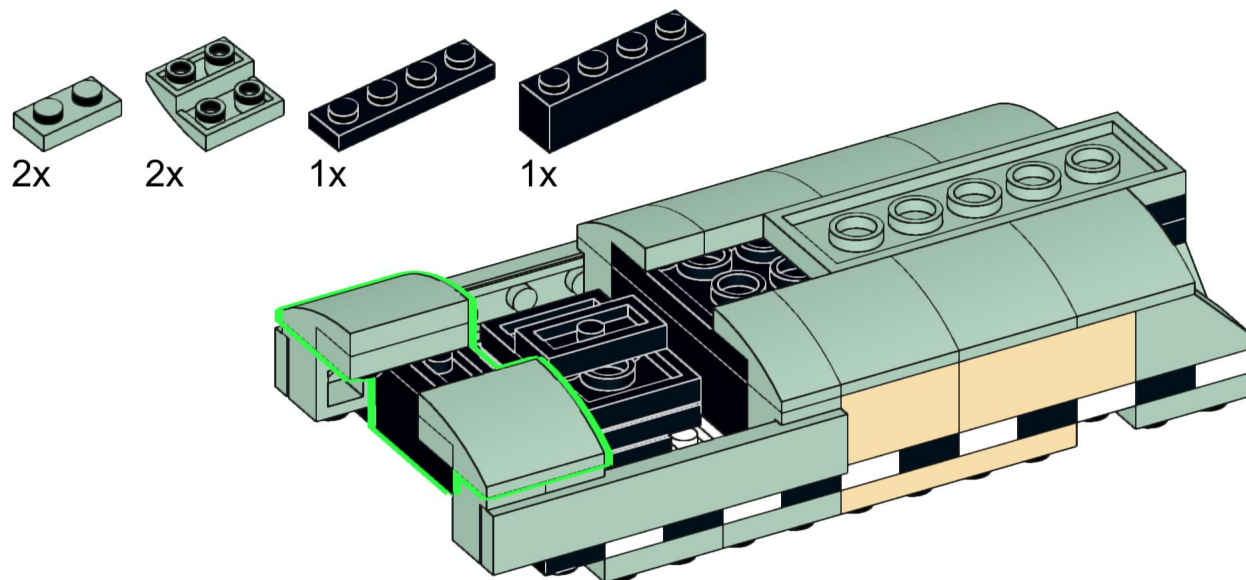

# 71

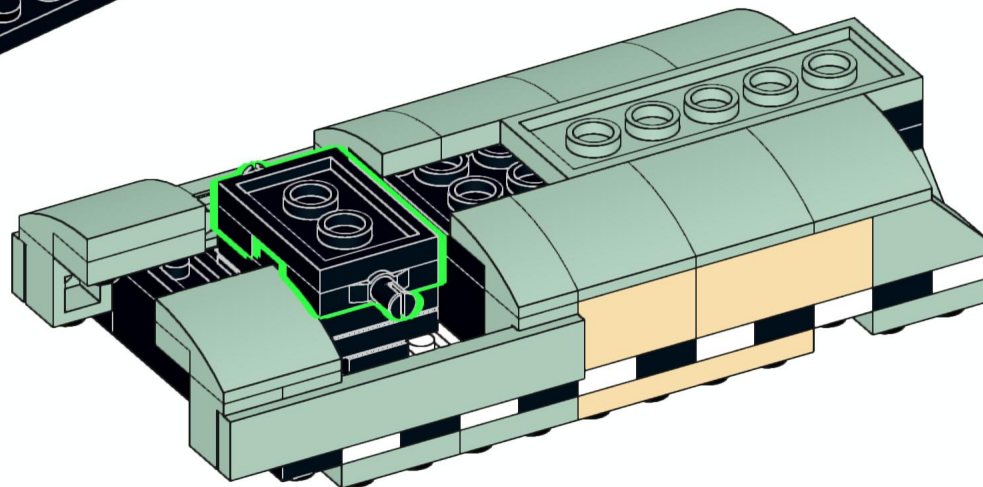
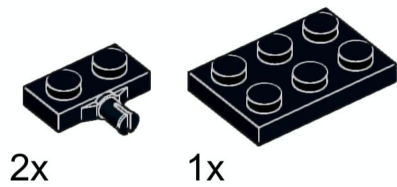

# 72

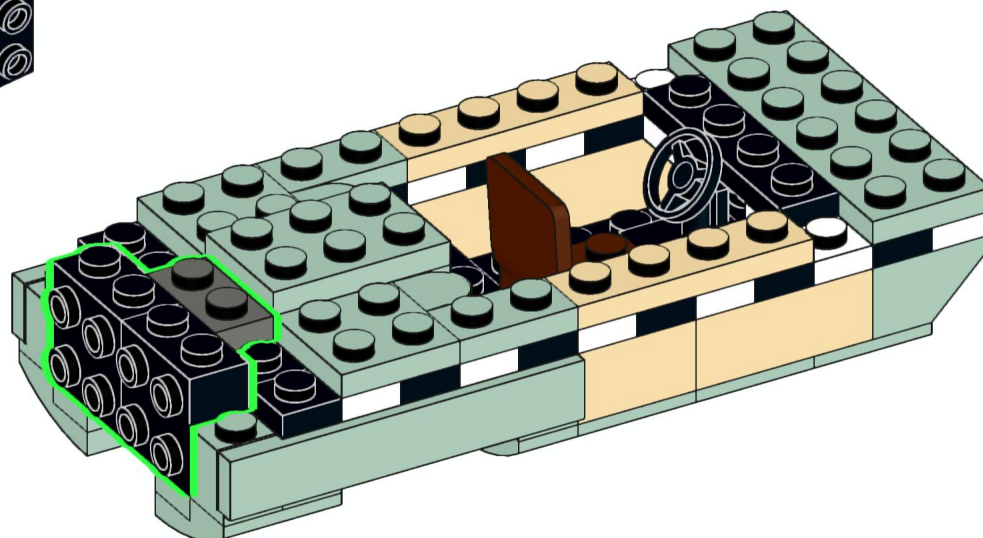
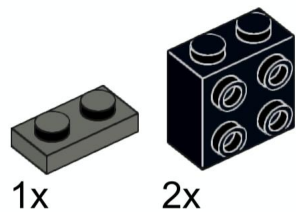

# 73

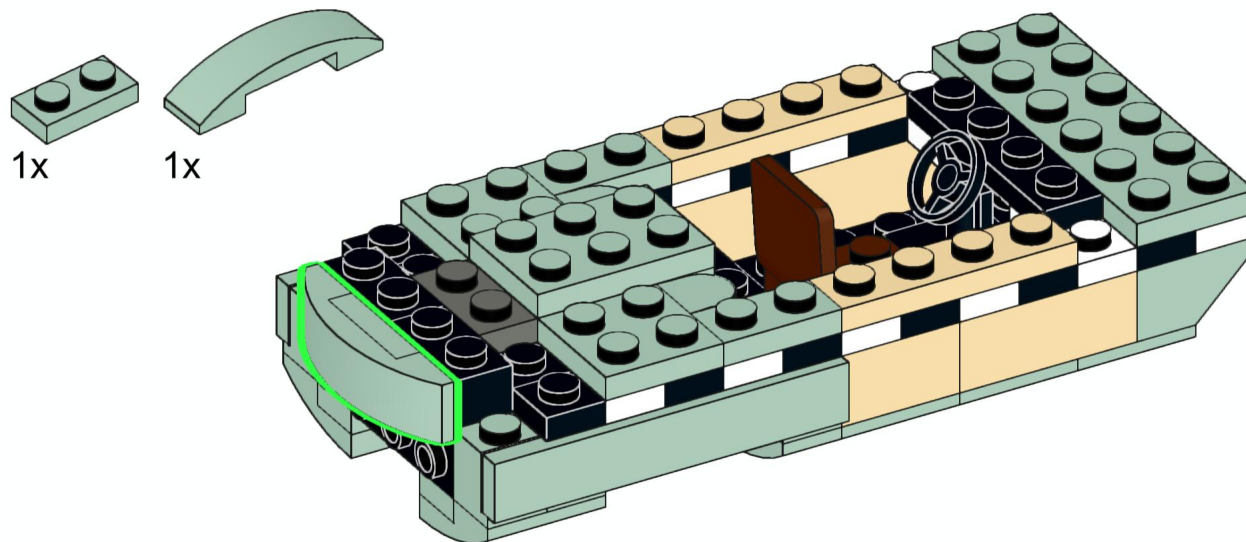

# 74

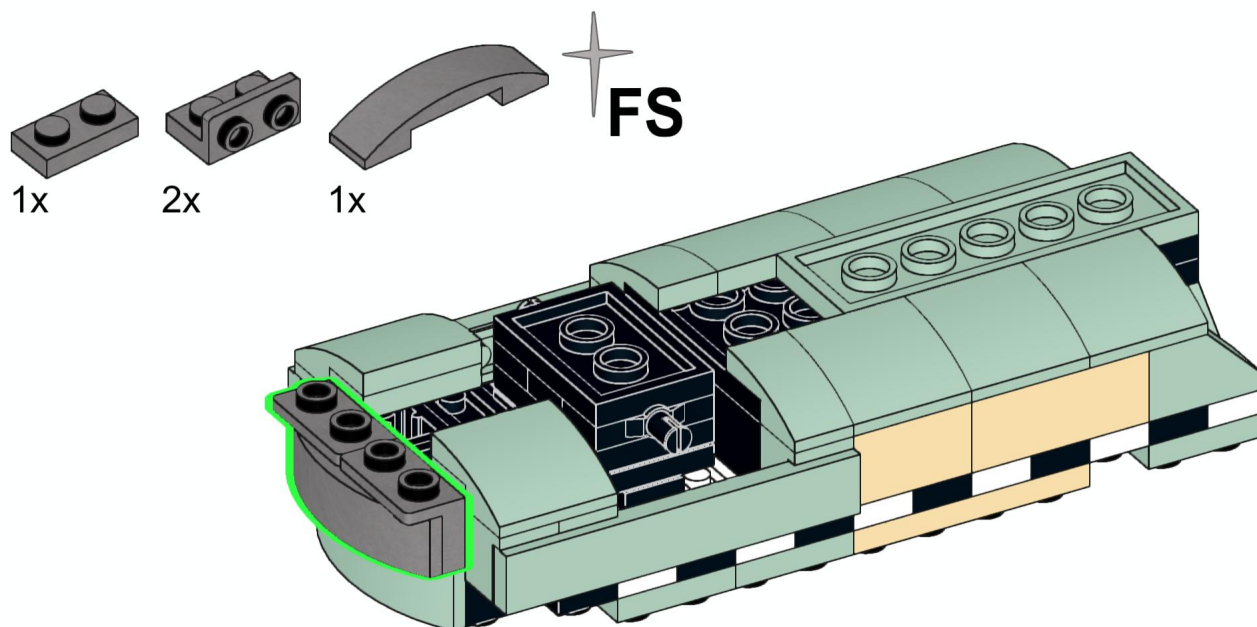

# 75

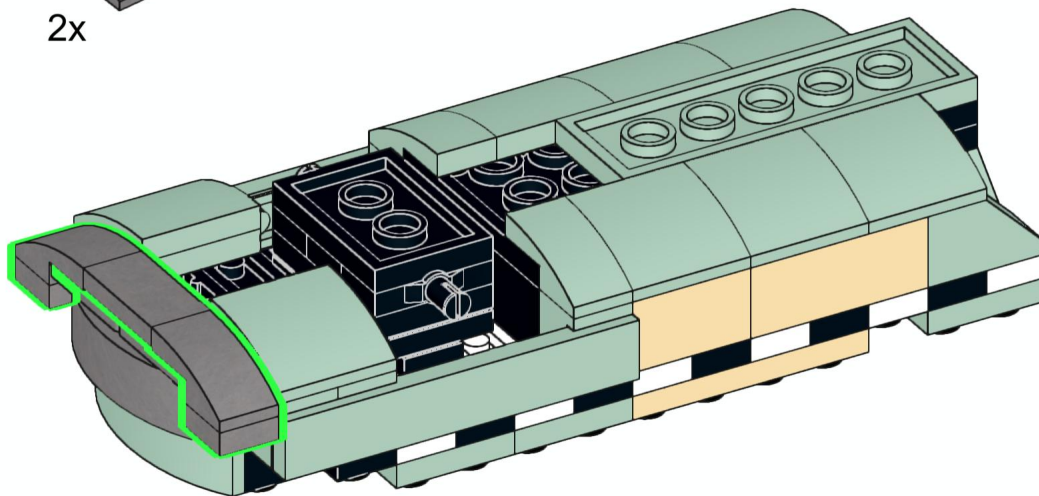
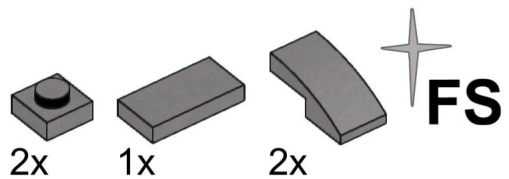

# 76

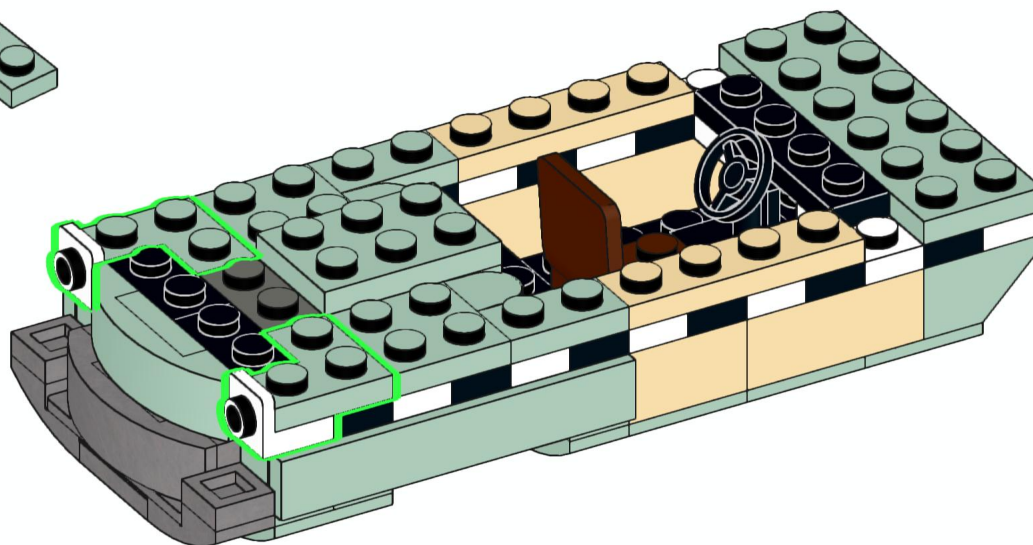
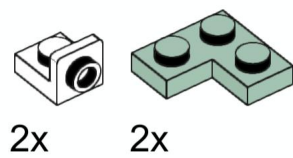

# 77

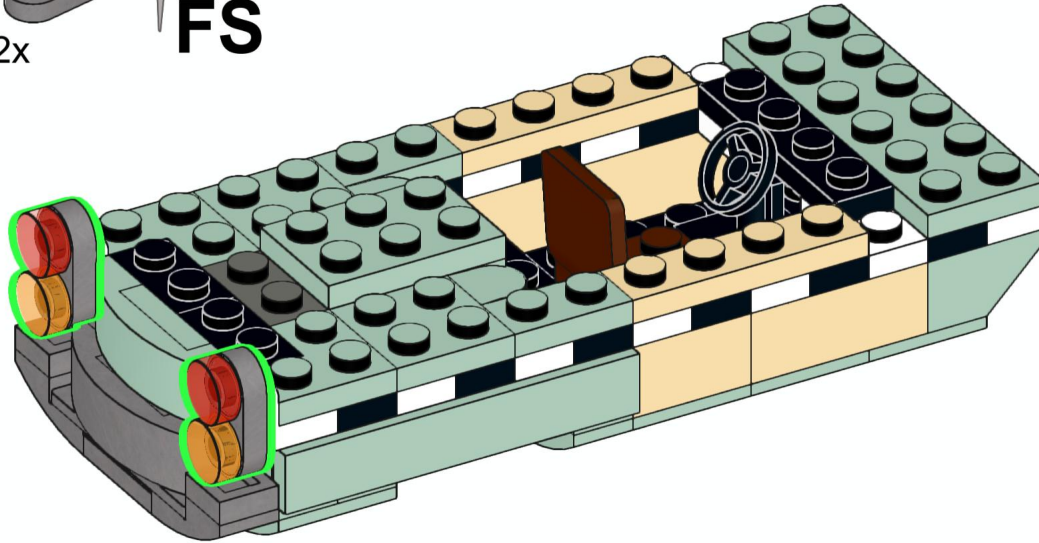
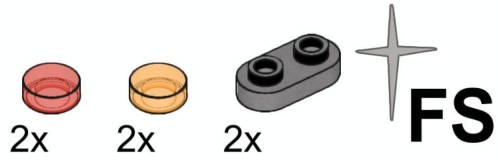

# 78

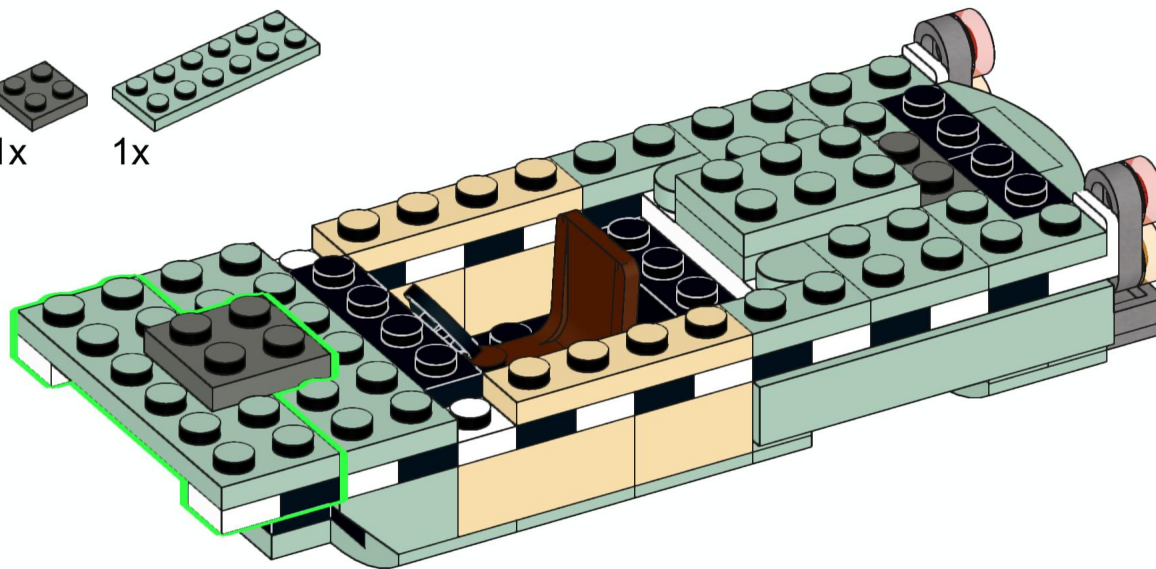
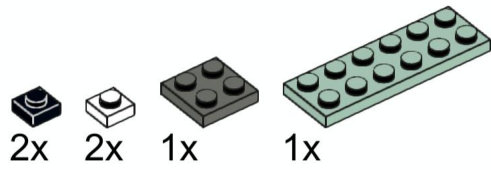



# 79

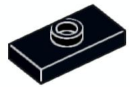

3x

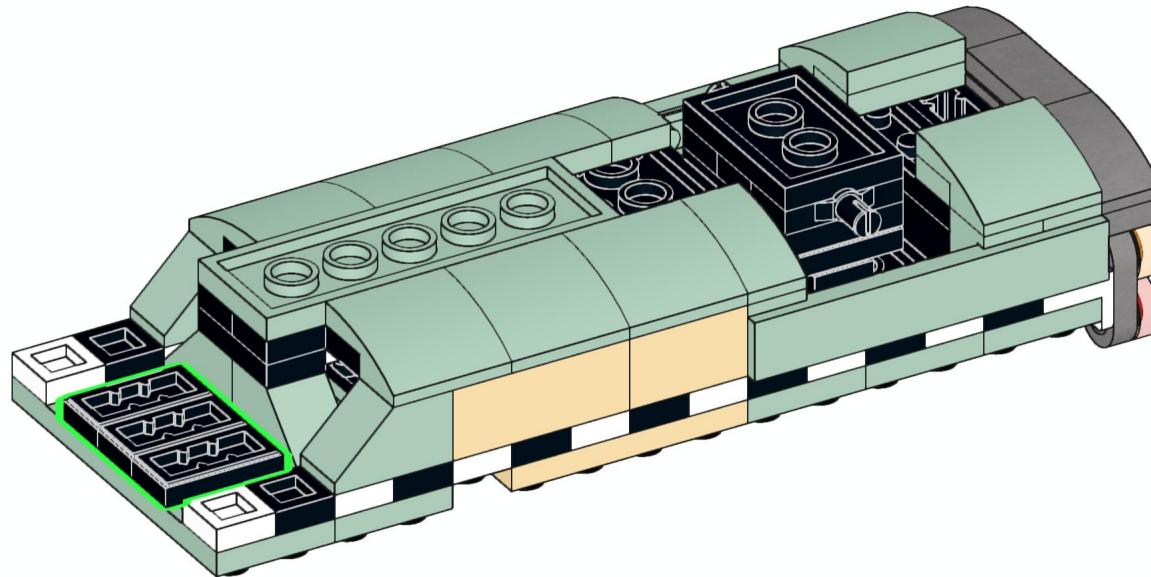

# 80



1x



1x

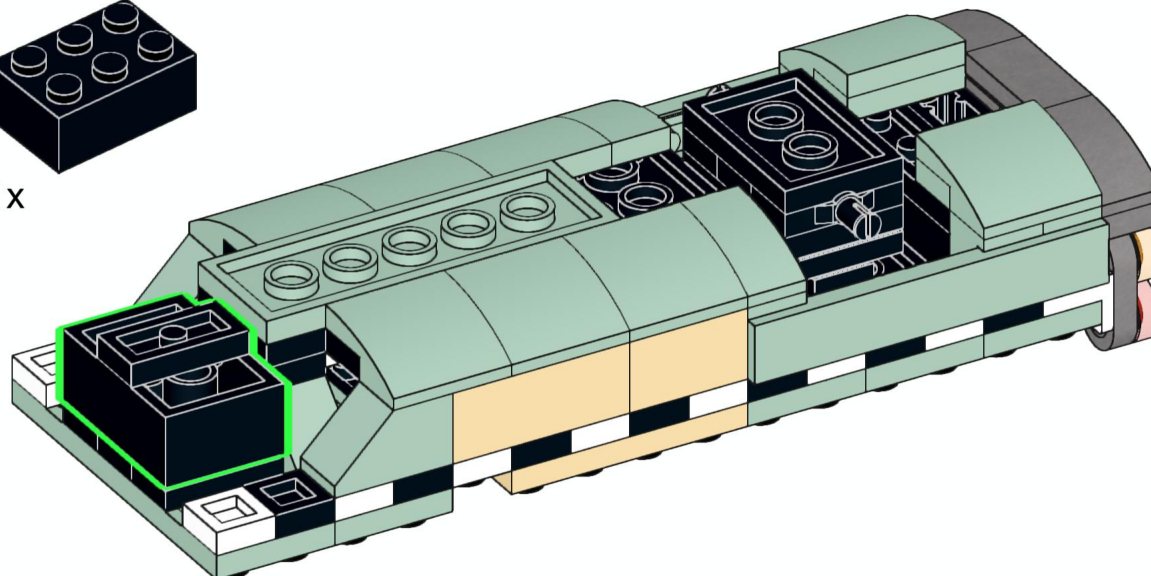

# 81

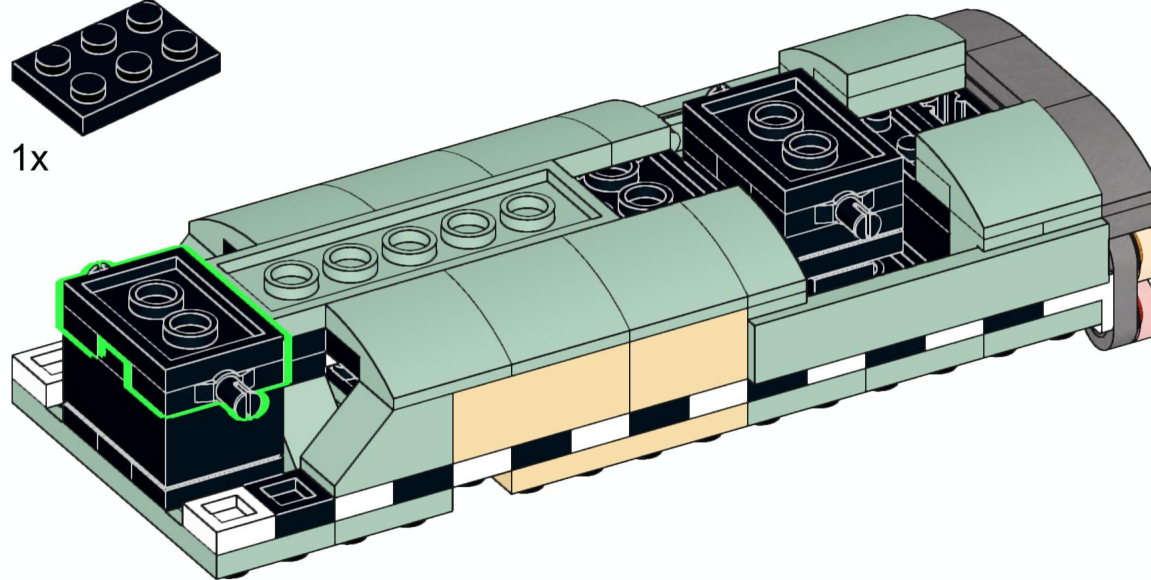
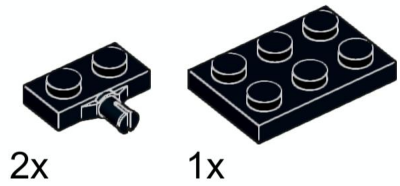

# 82

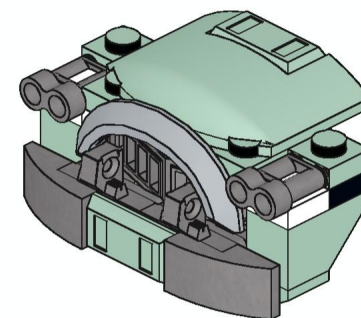
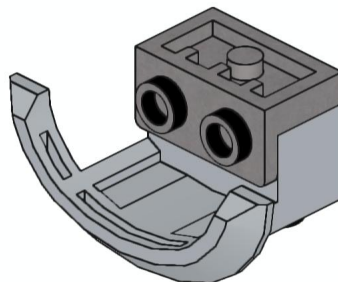
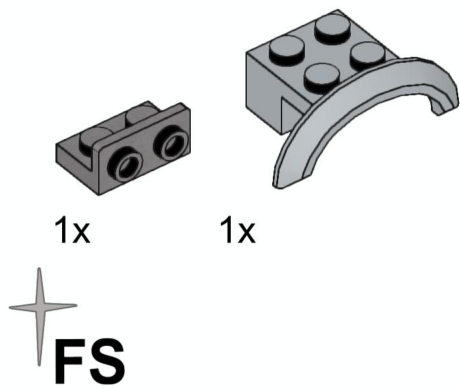

# 83



2x

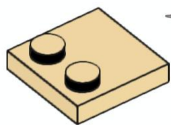

1x



FS

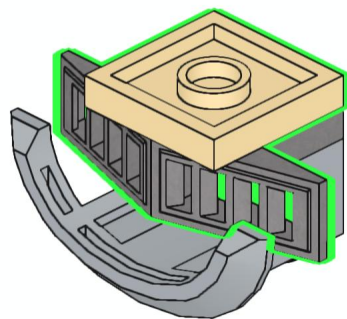

# 84

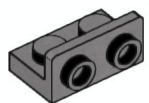

2x



FS

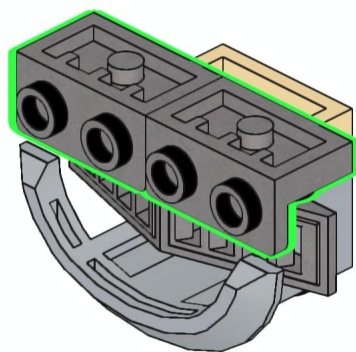

# 85

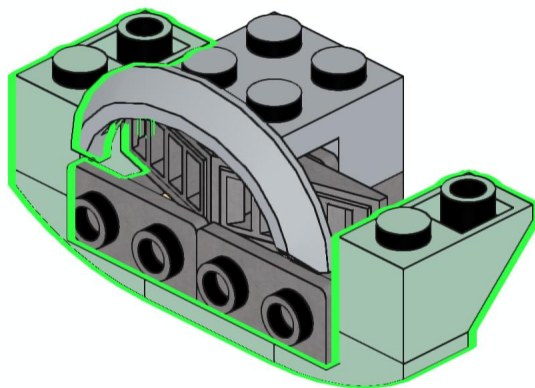
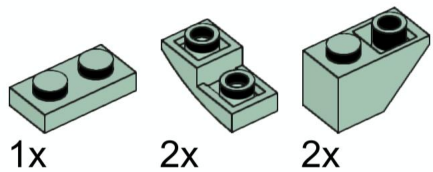

# 86

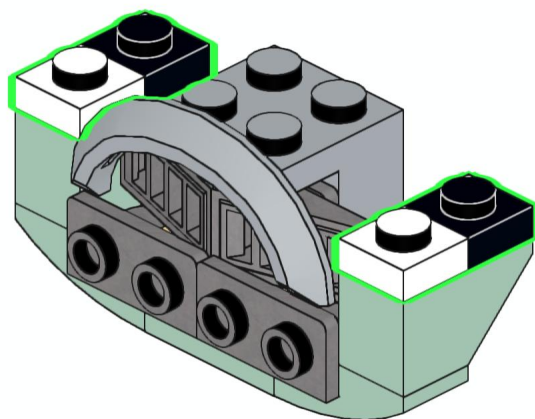
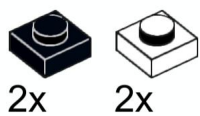

# 87

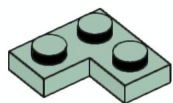

2x

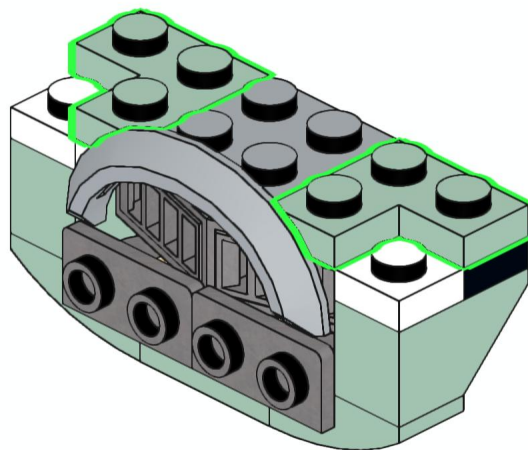

# 88

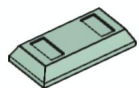

1x

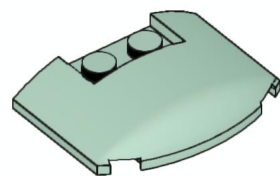

1x

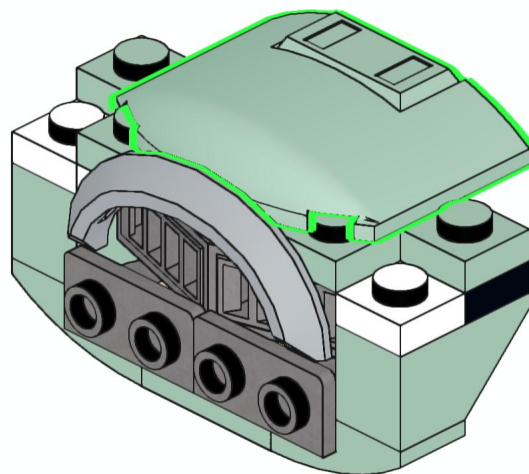

# 89

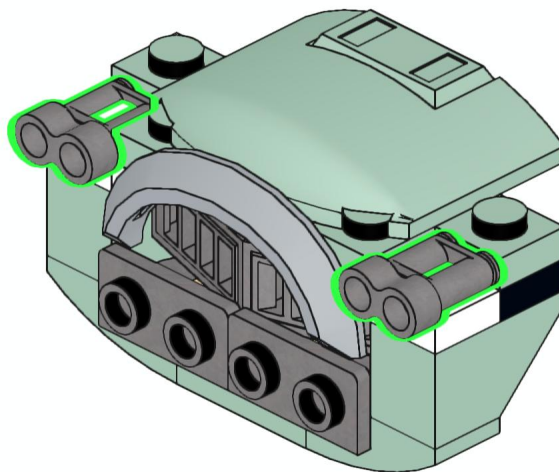
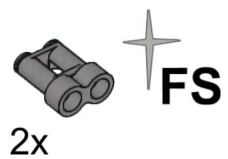

# 90

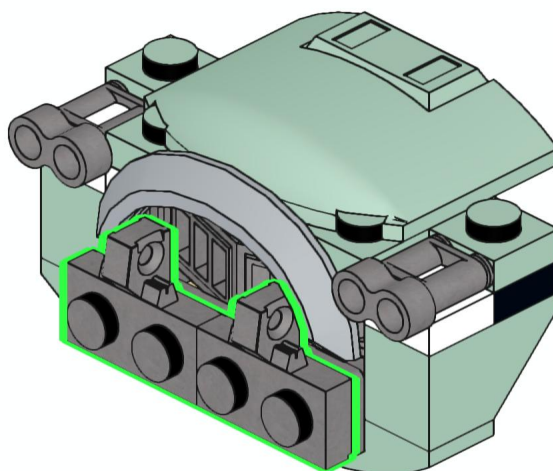
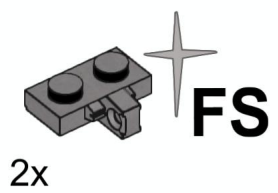

# 91

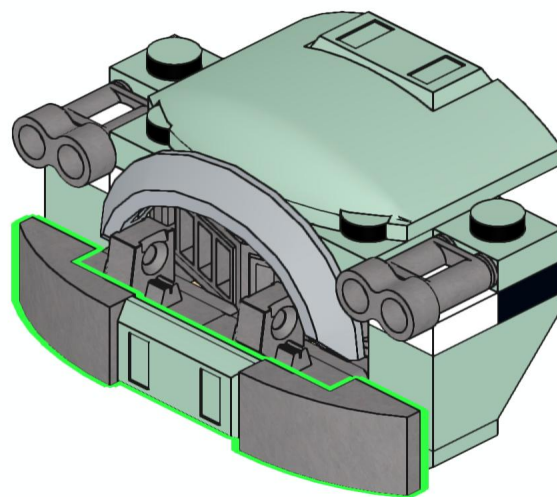
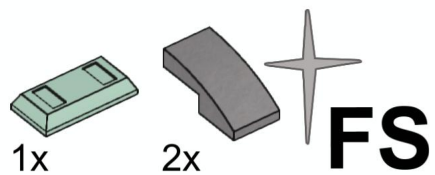

# 92

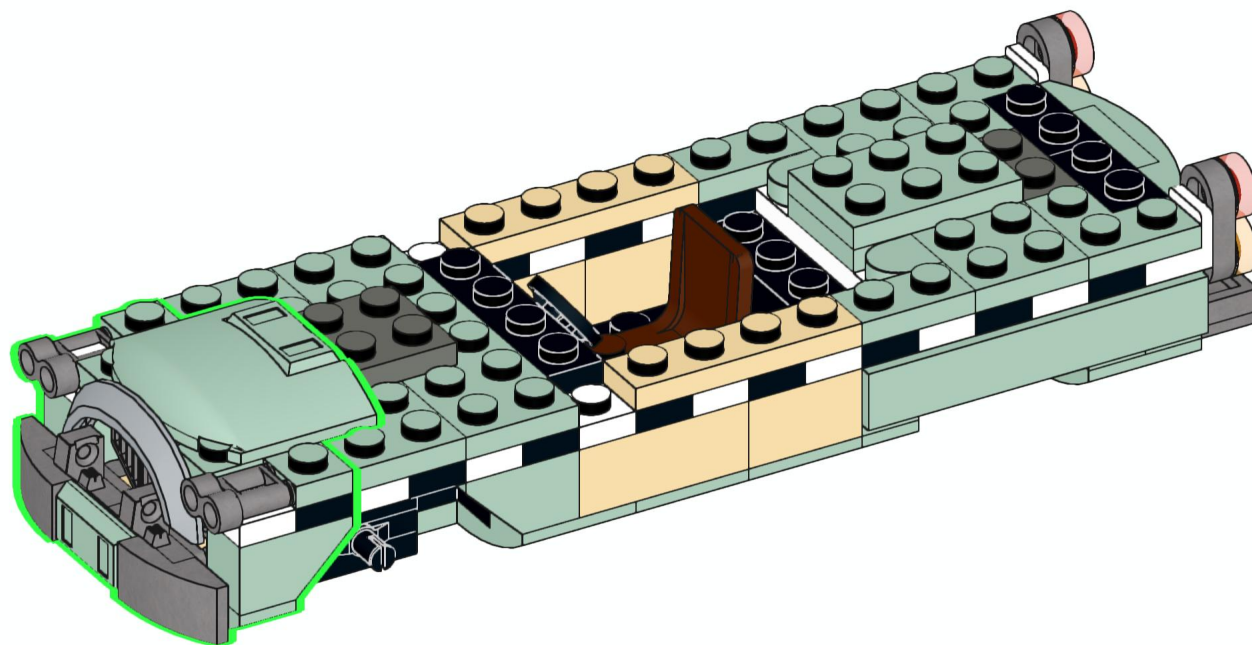

# 93



2x



2x



FS

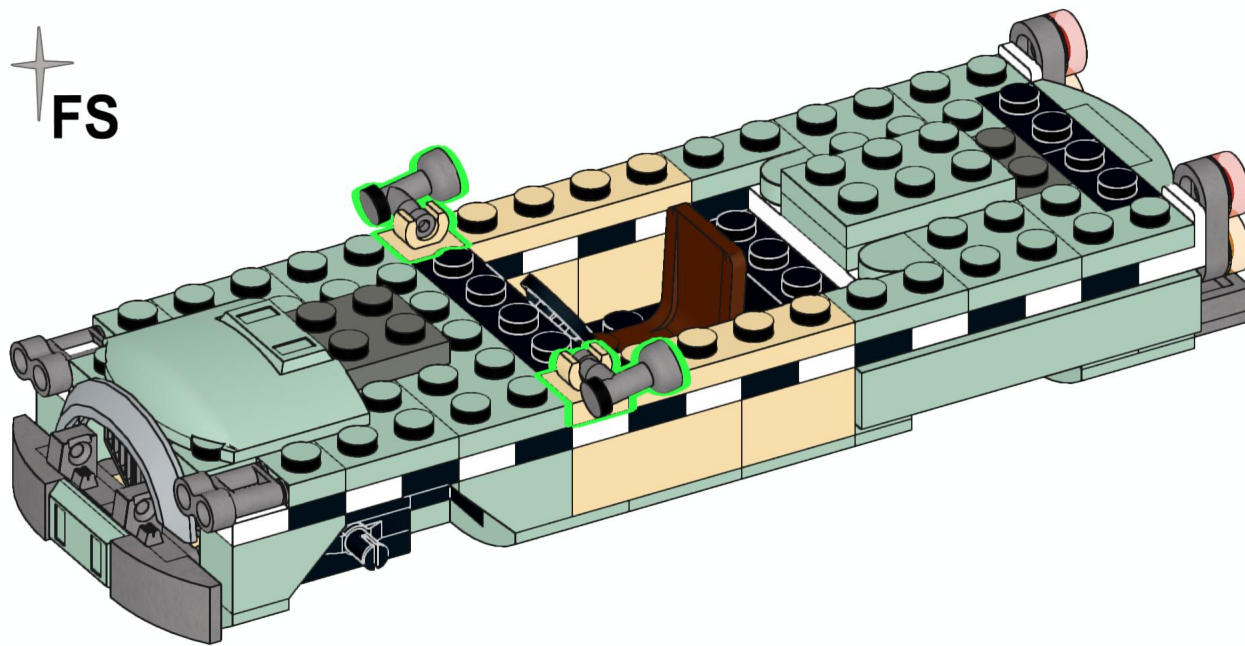

# 94

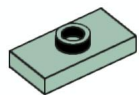

4x

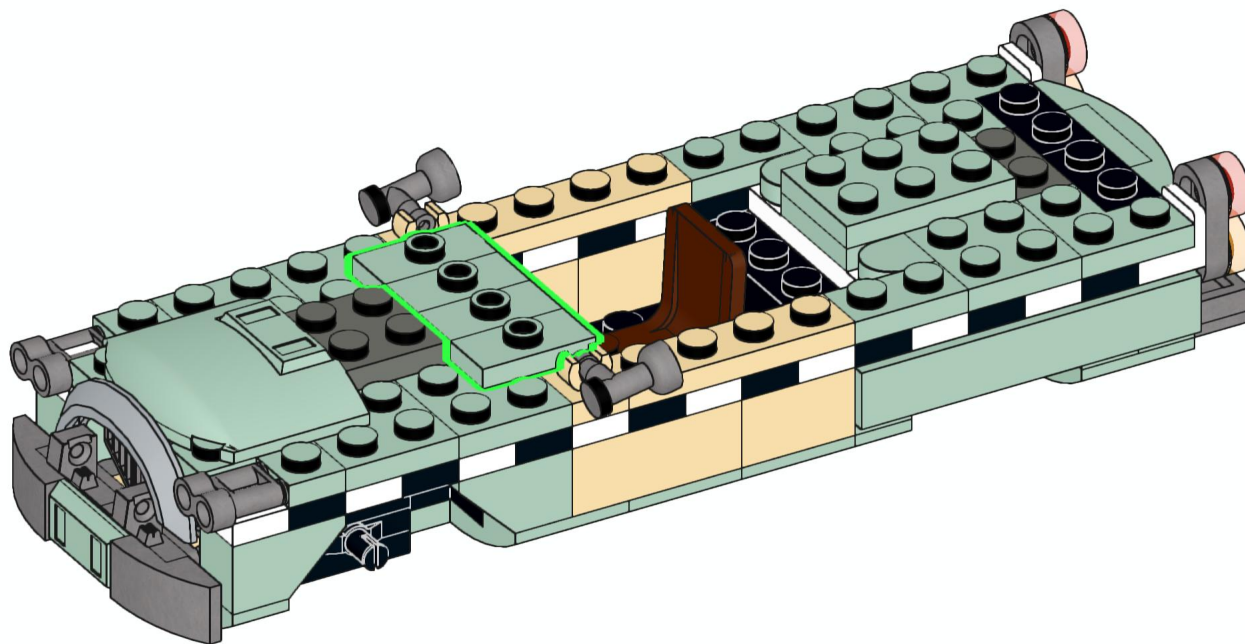



# 95

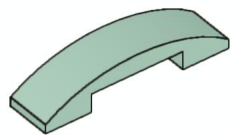

2x

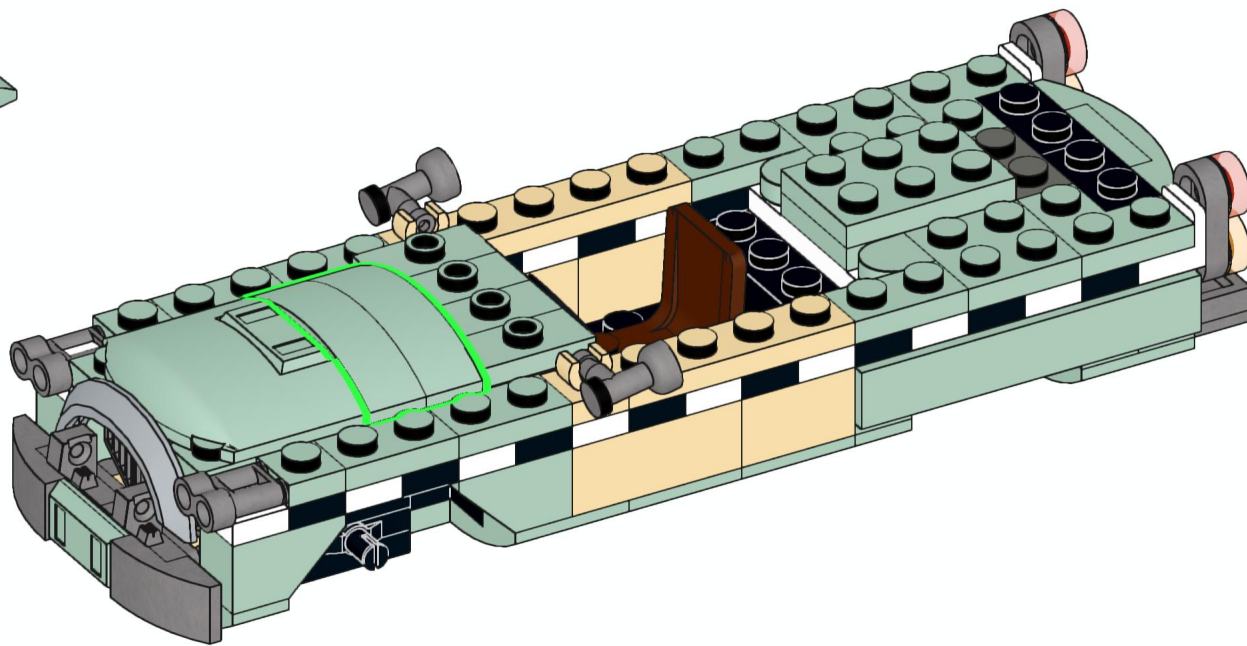

# 96



8x



12x

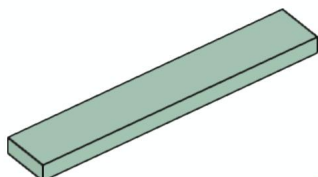

2x

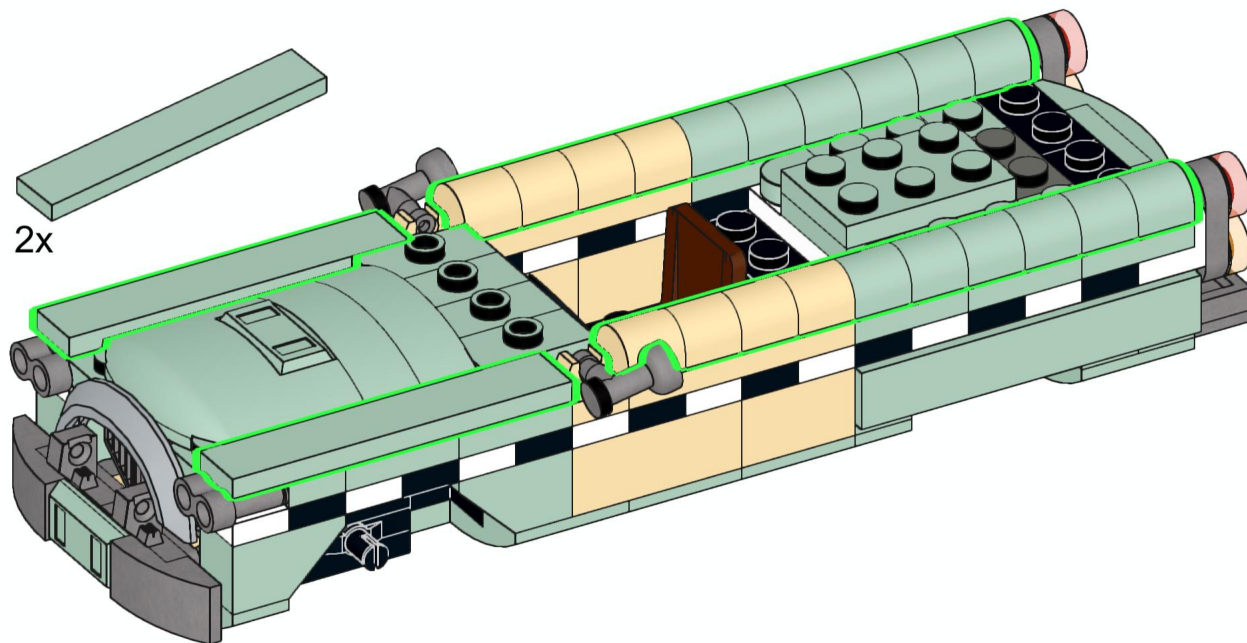

# 97

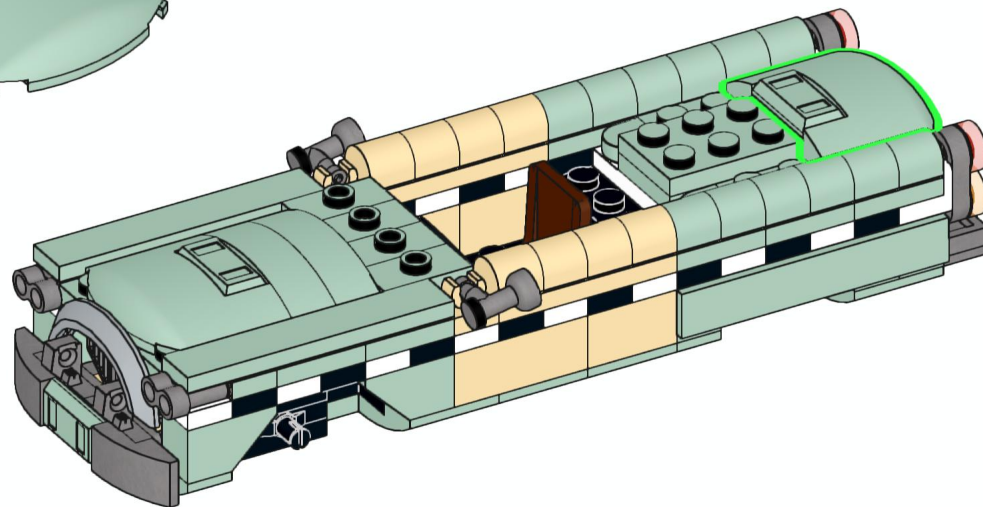
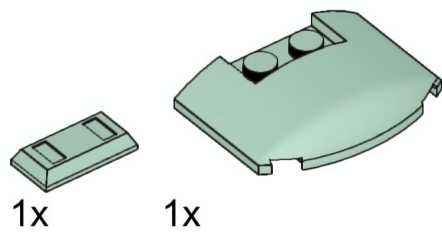

# 98

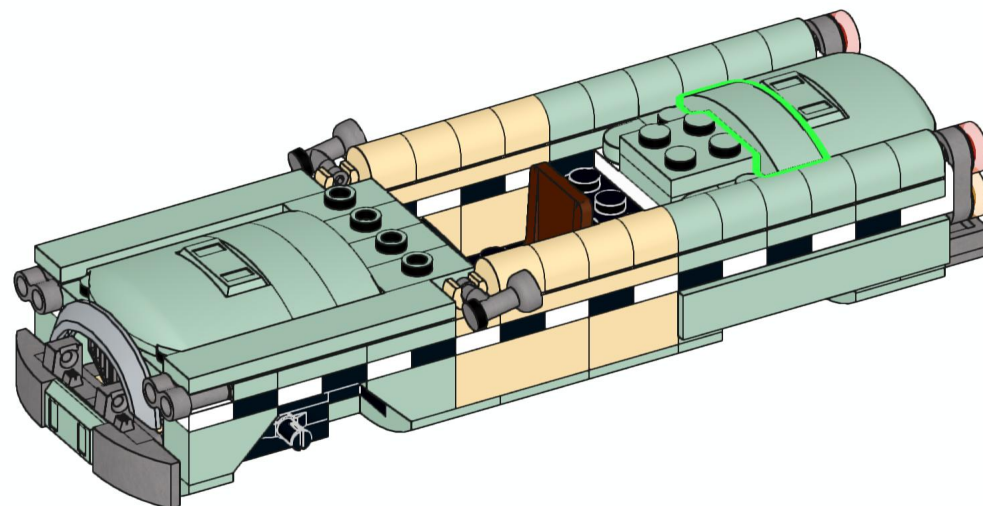
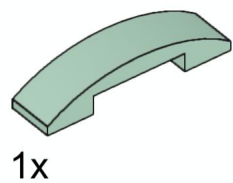

# 99

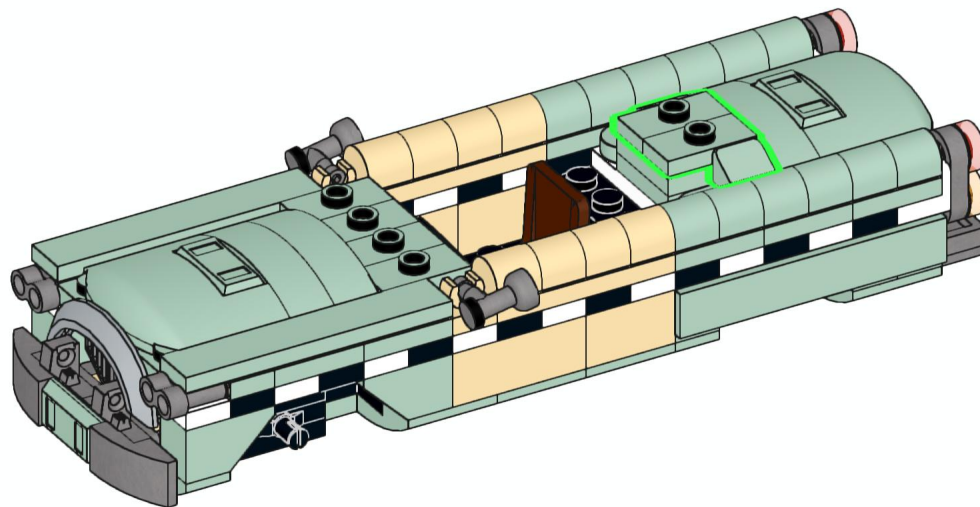
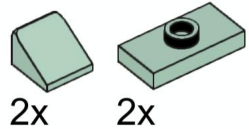

# 100

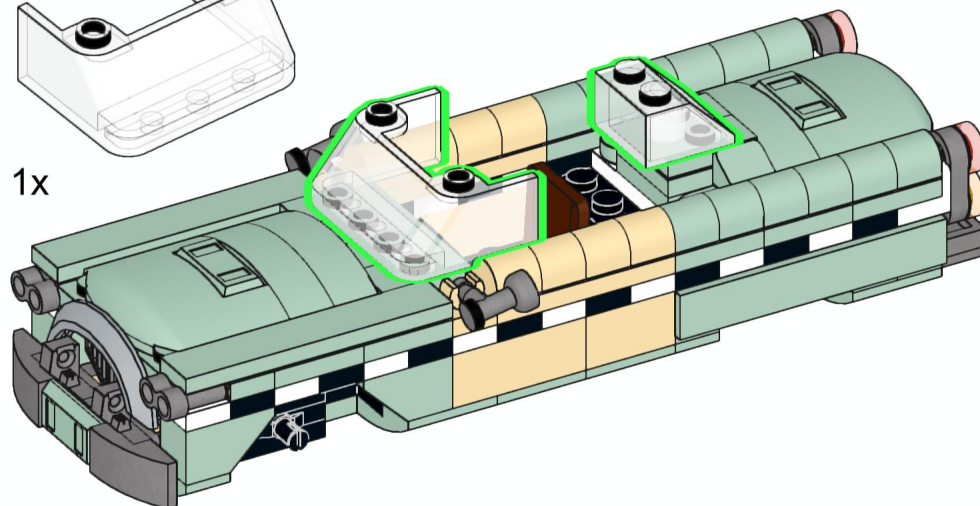
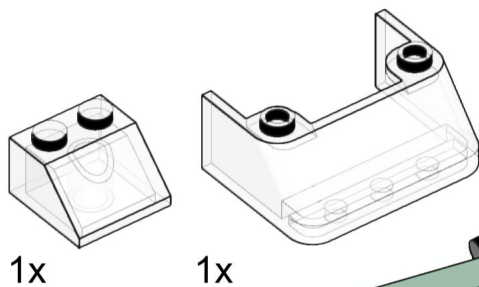

# 101



1x

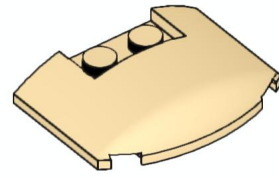

1x

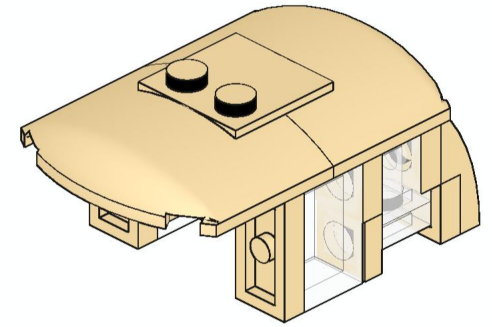
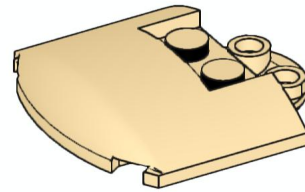

# 102

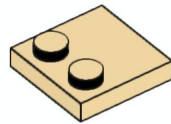

1x

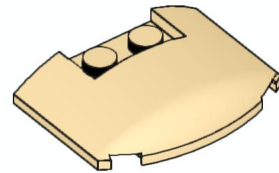

1x

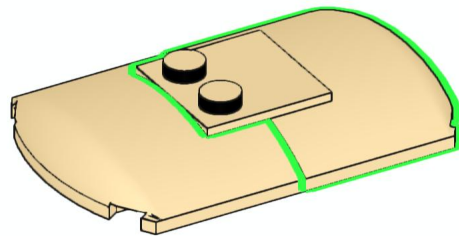

# 103

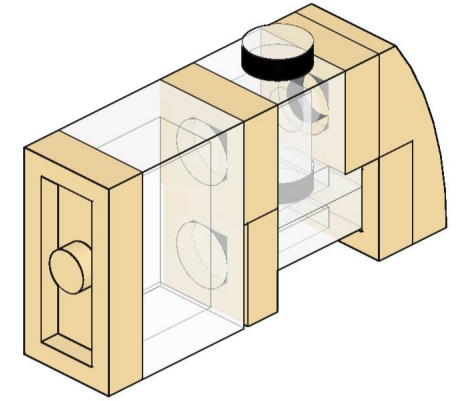
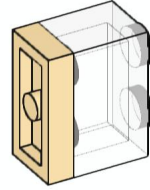
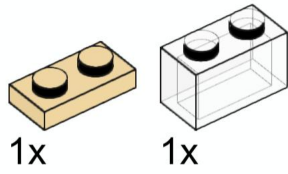

# X2

# 104

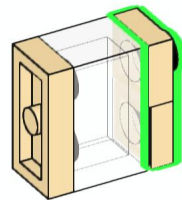
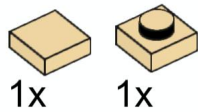

# 105

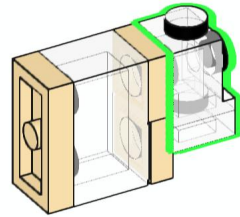
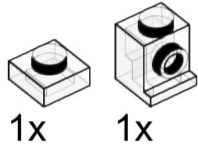

# 106

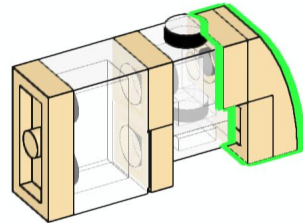
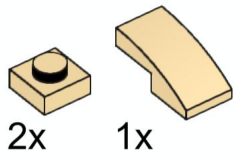

# 107

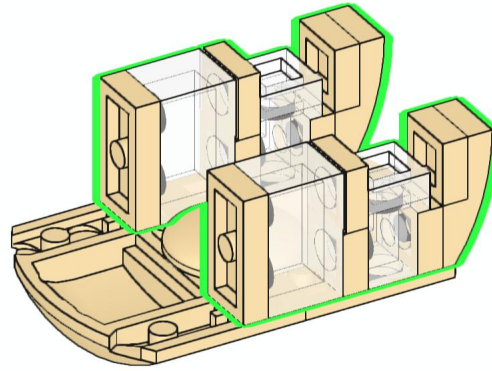

# 108

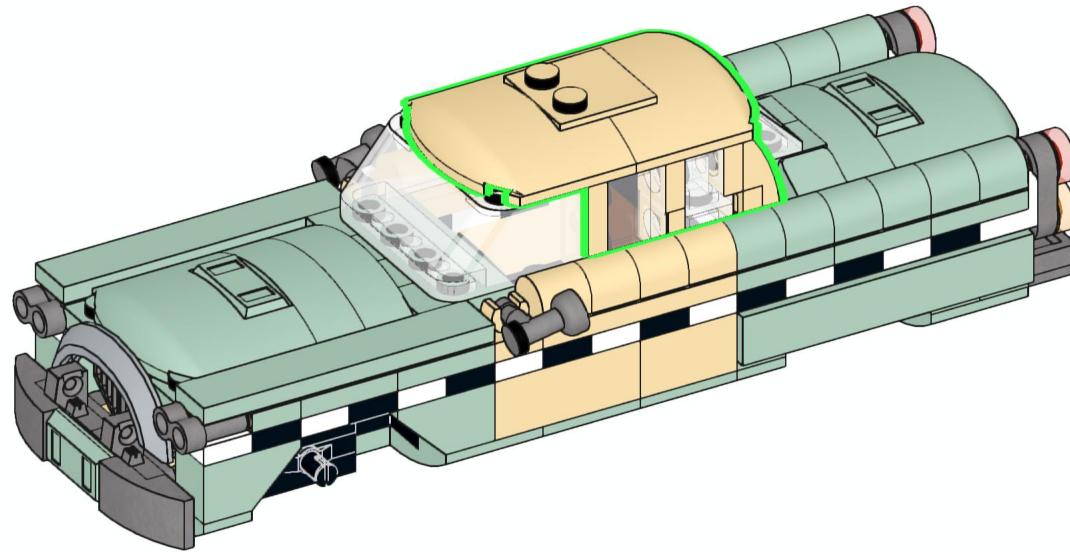

# 109

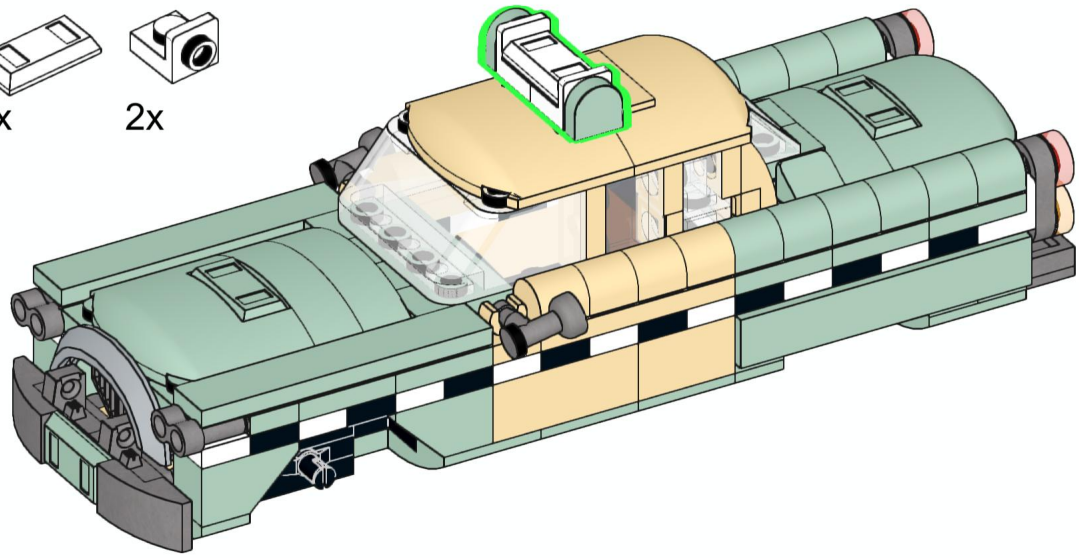
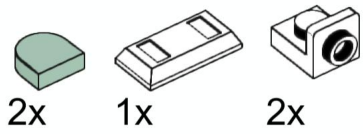

# 110

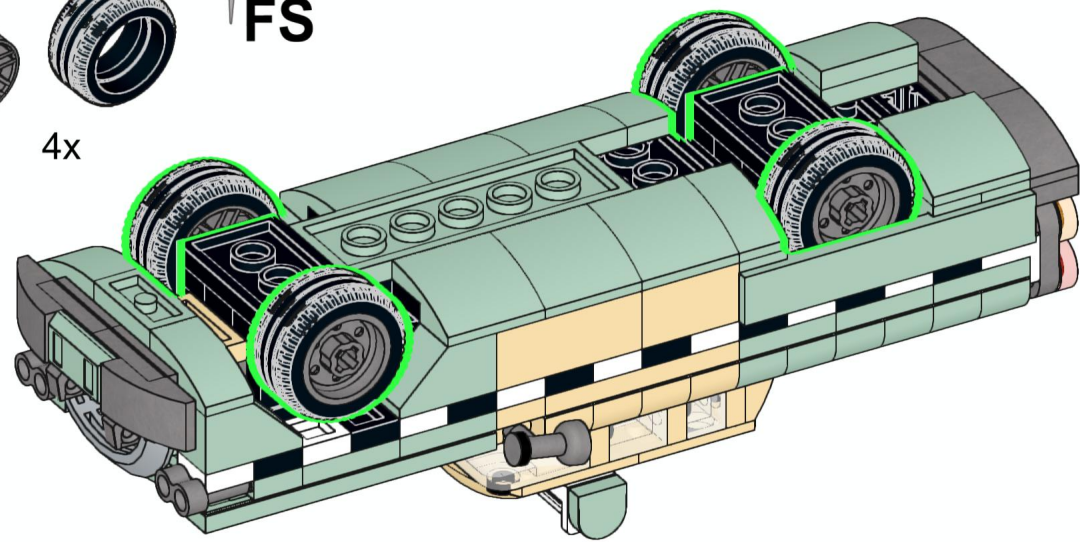



# 111

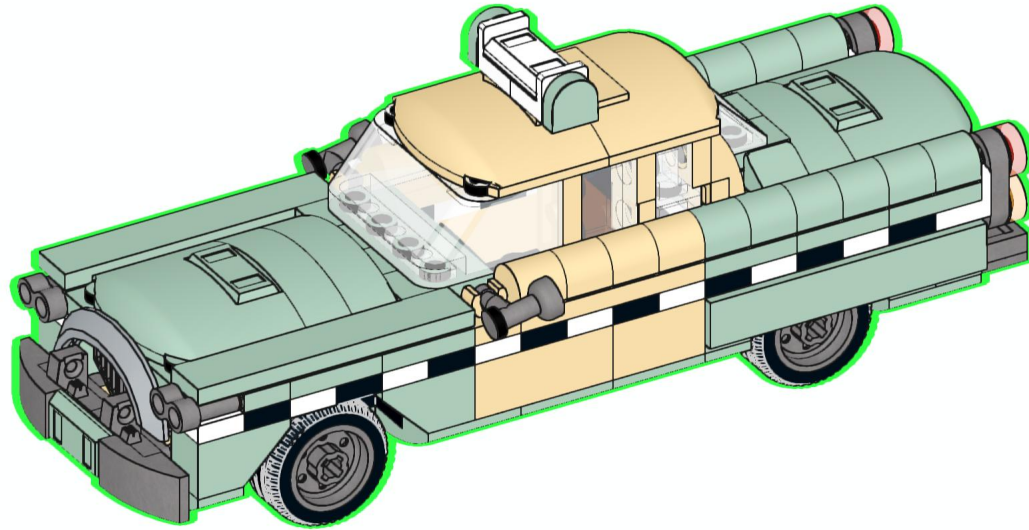

# 112

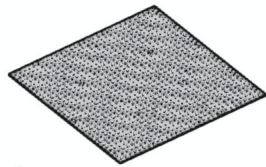

4x

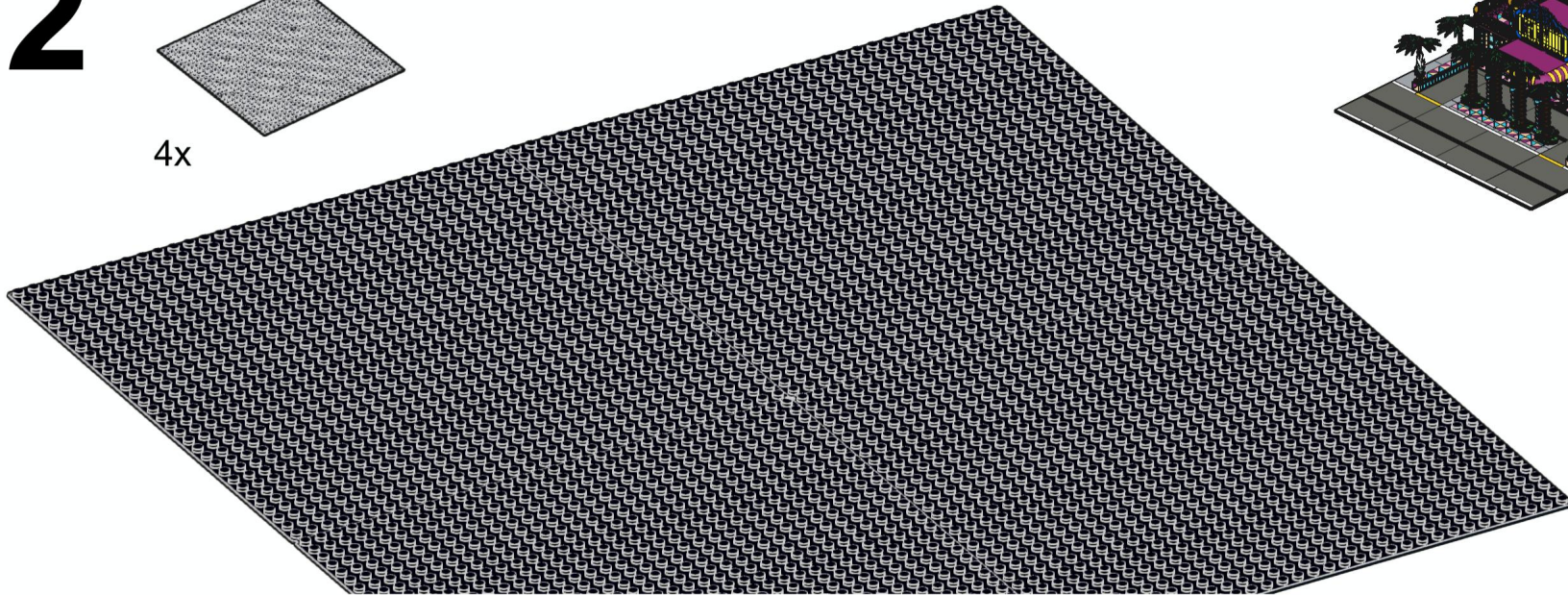

# 113

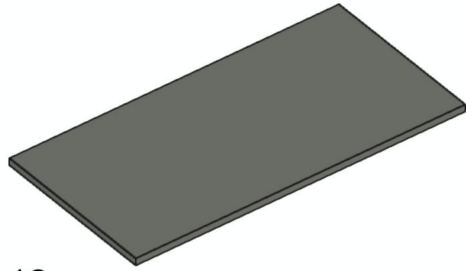

12x

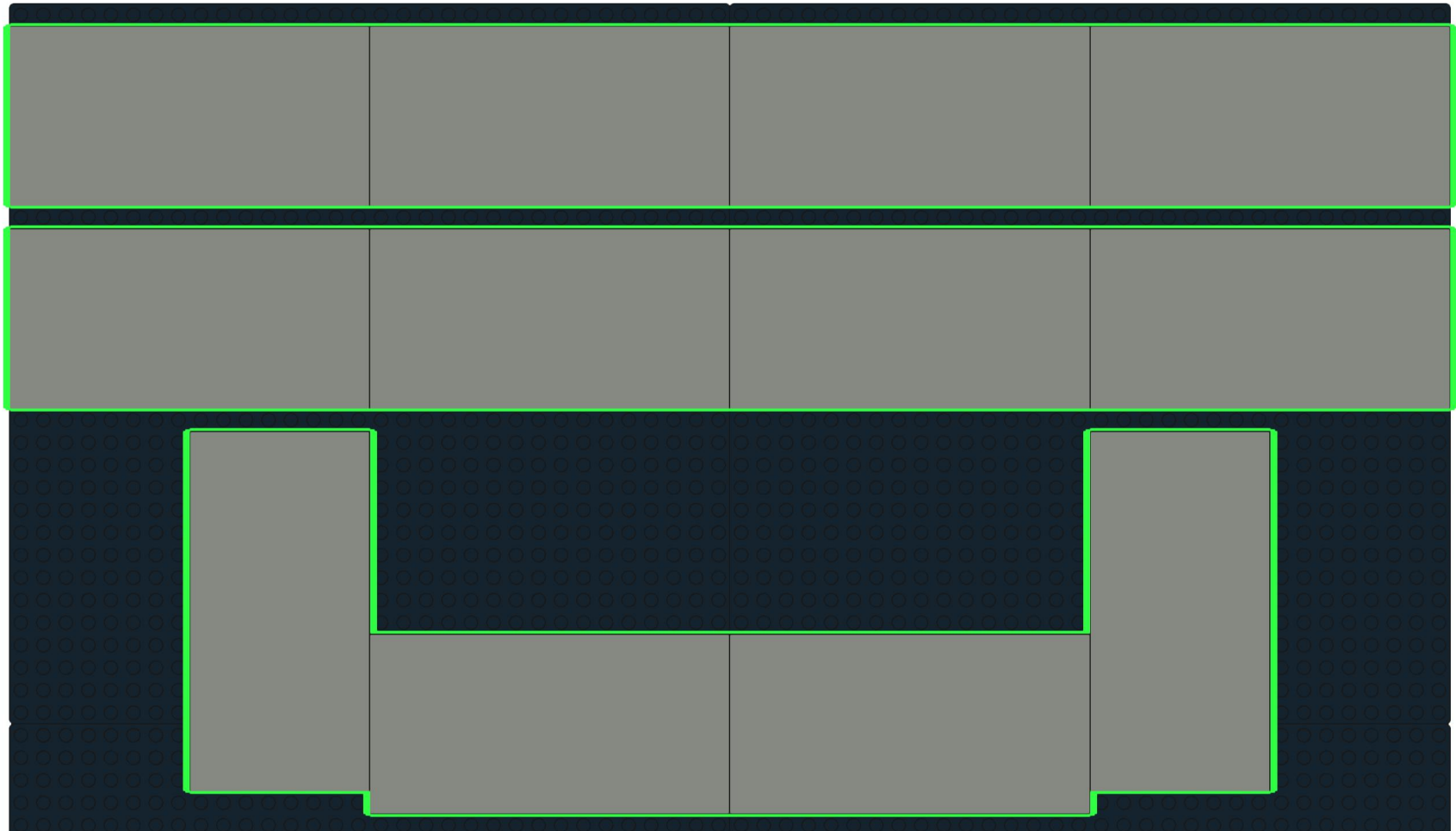

# 114

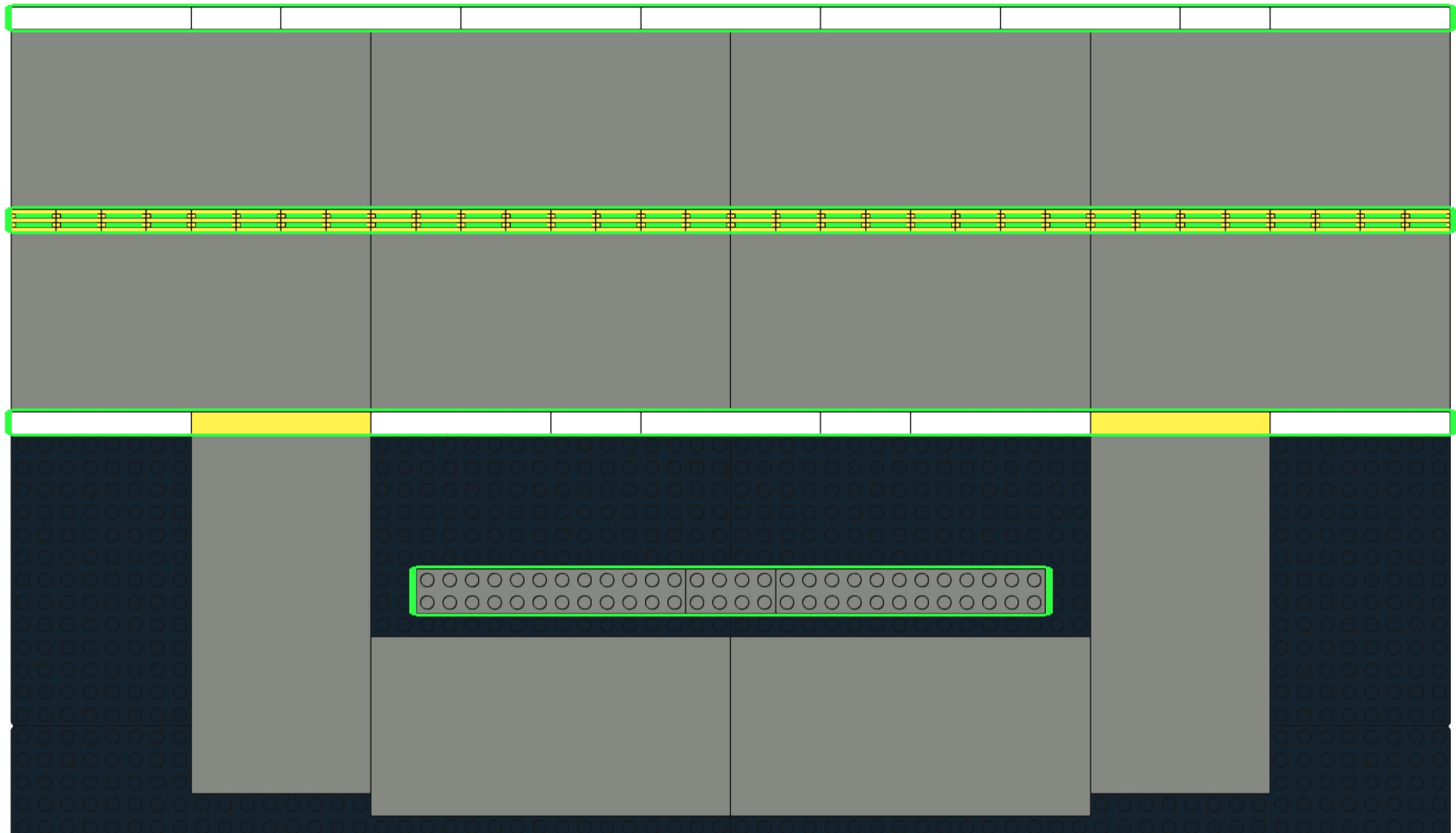
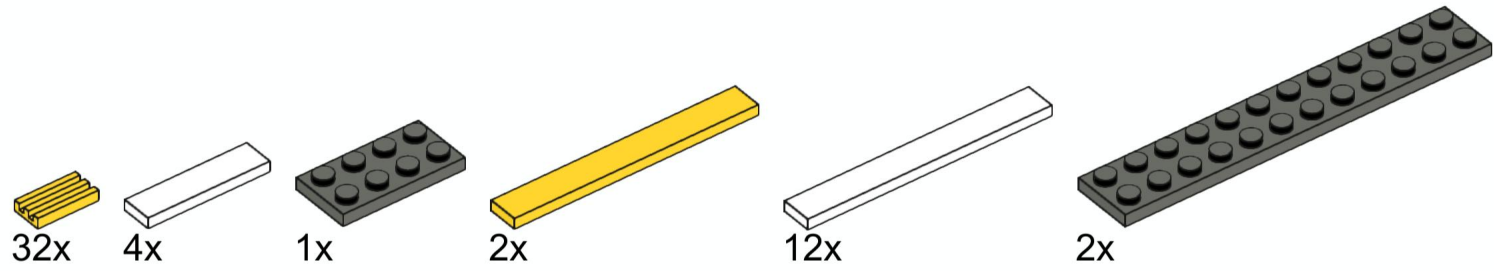

# 115

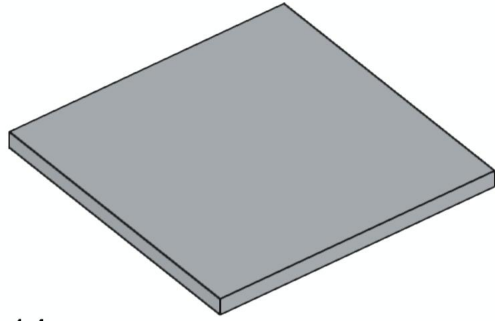

14x

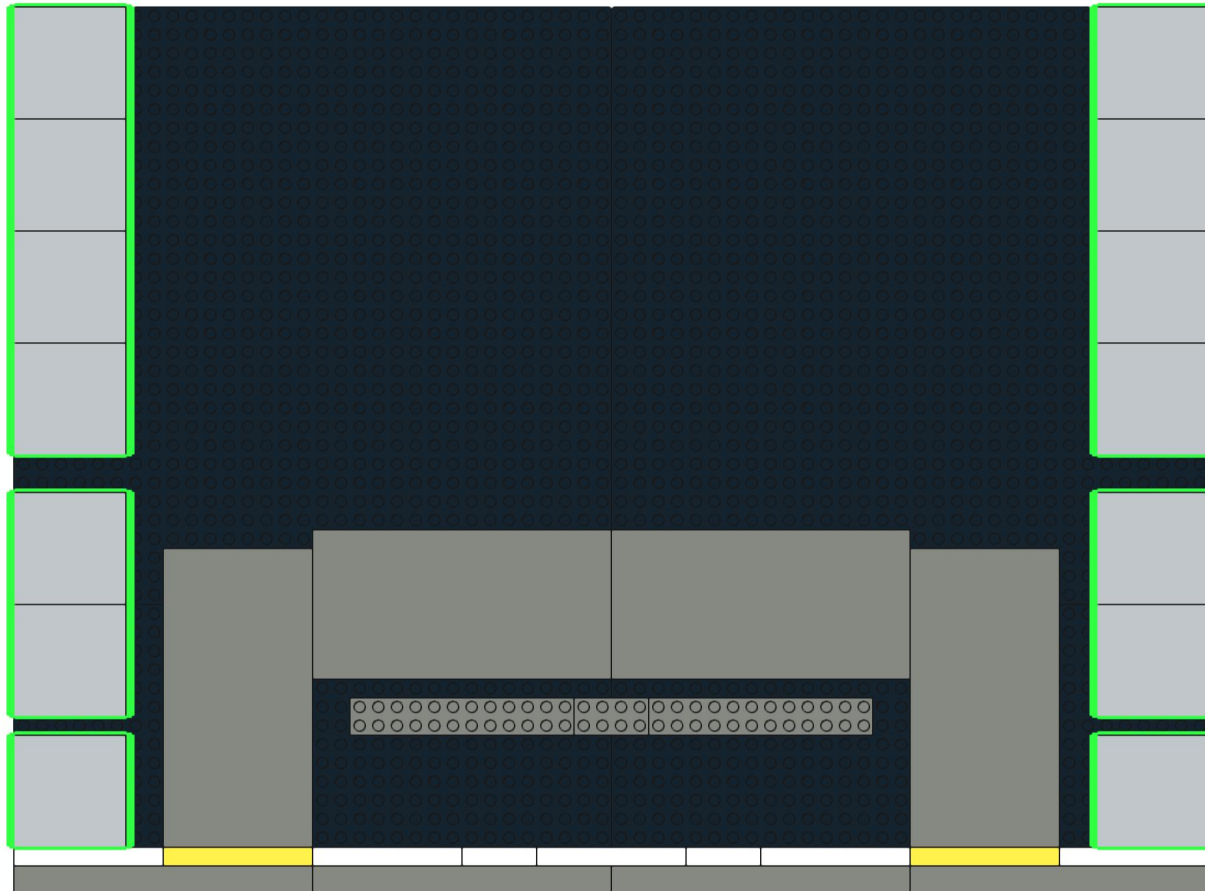

# 116

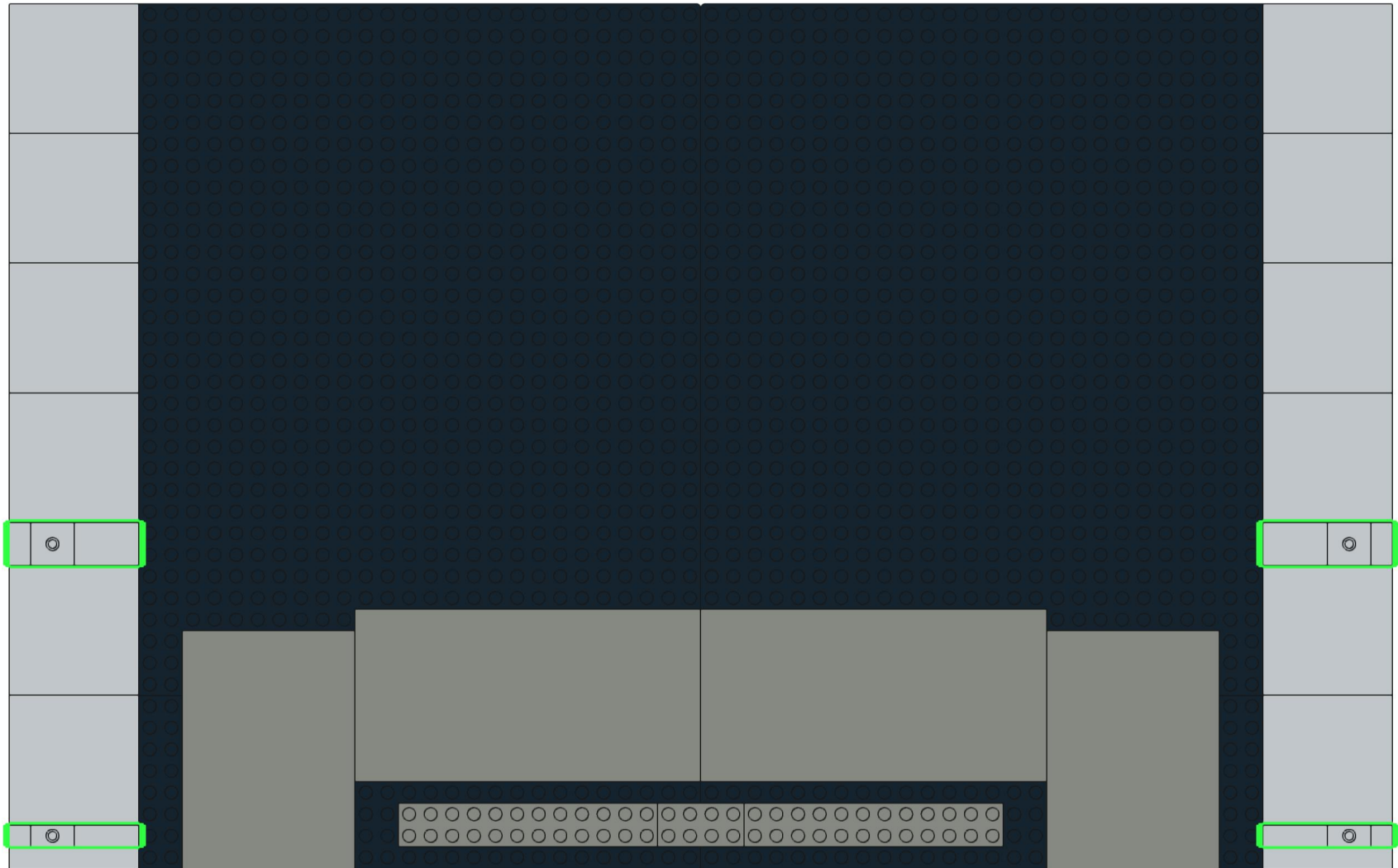
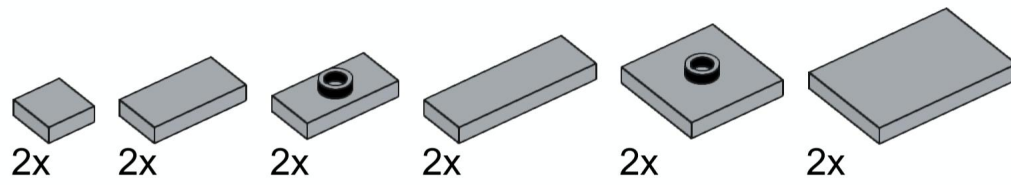

# 117

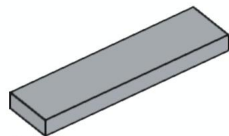

3x

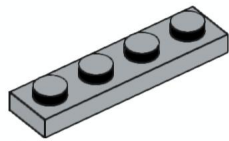

4x

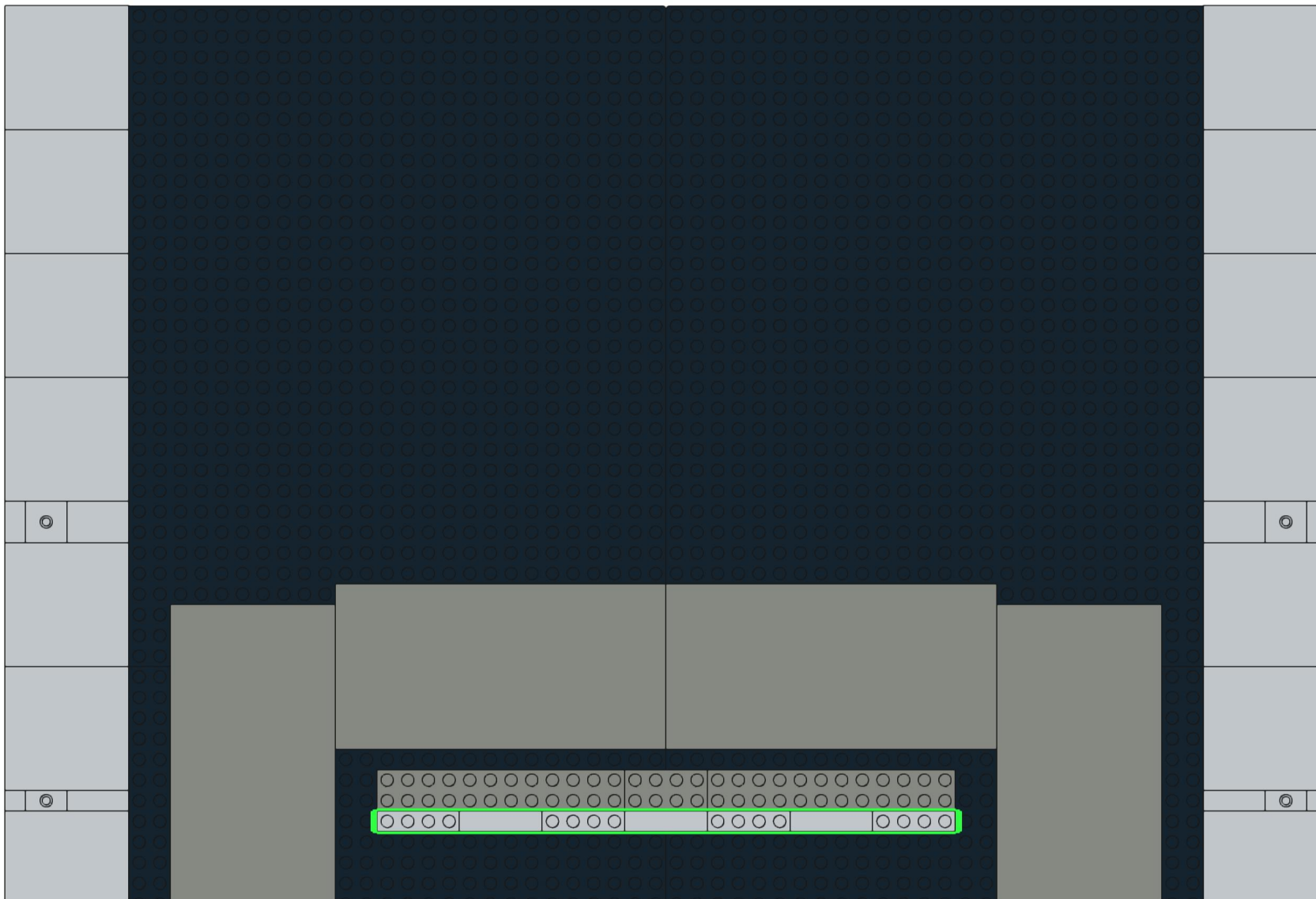

# 118

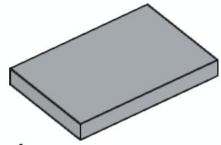

4x

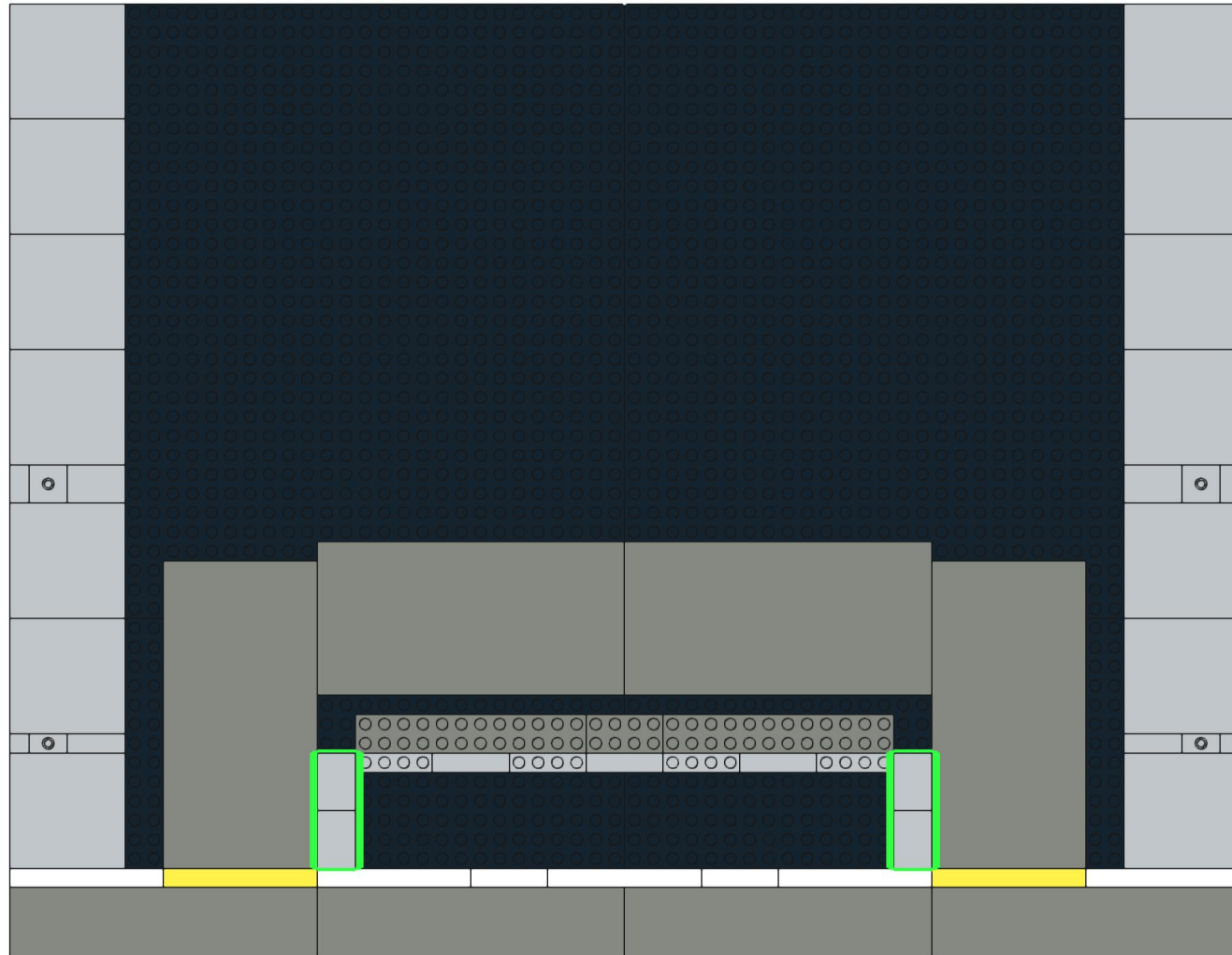

# 119

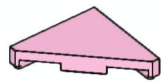

14x

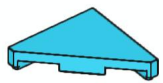

14x

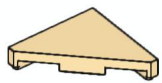

14x



14x

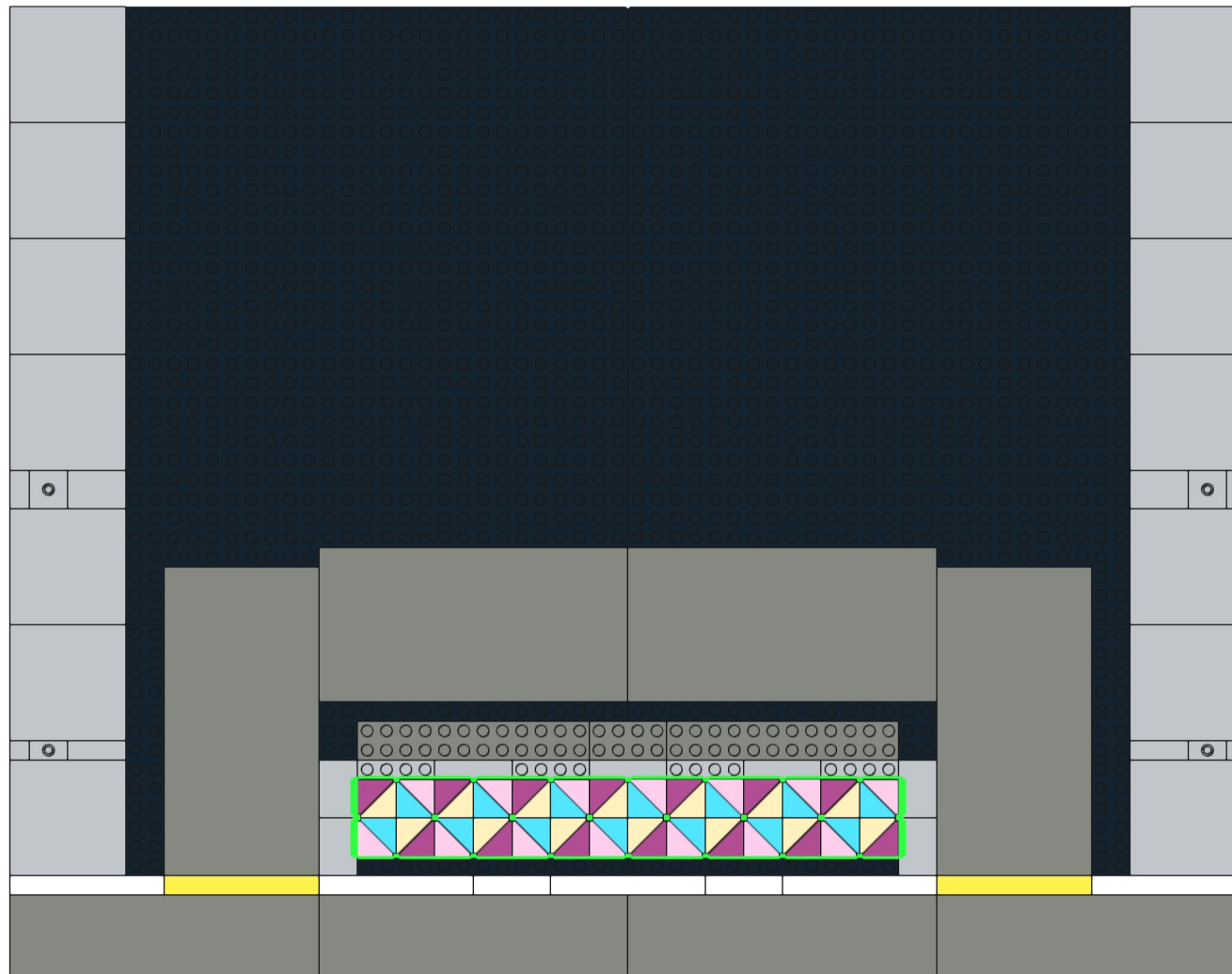



# 120

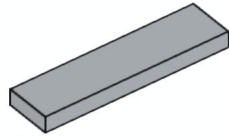

1x

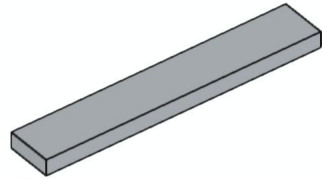

4x

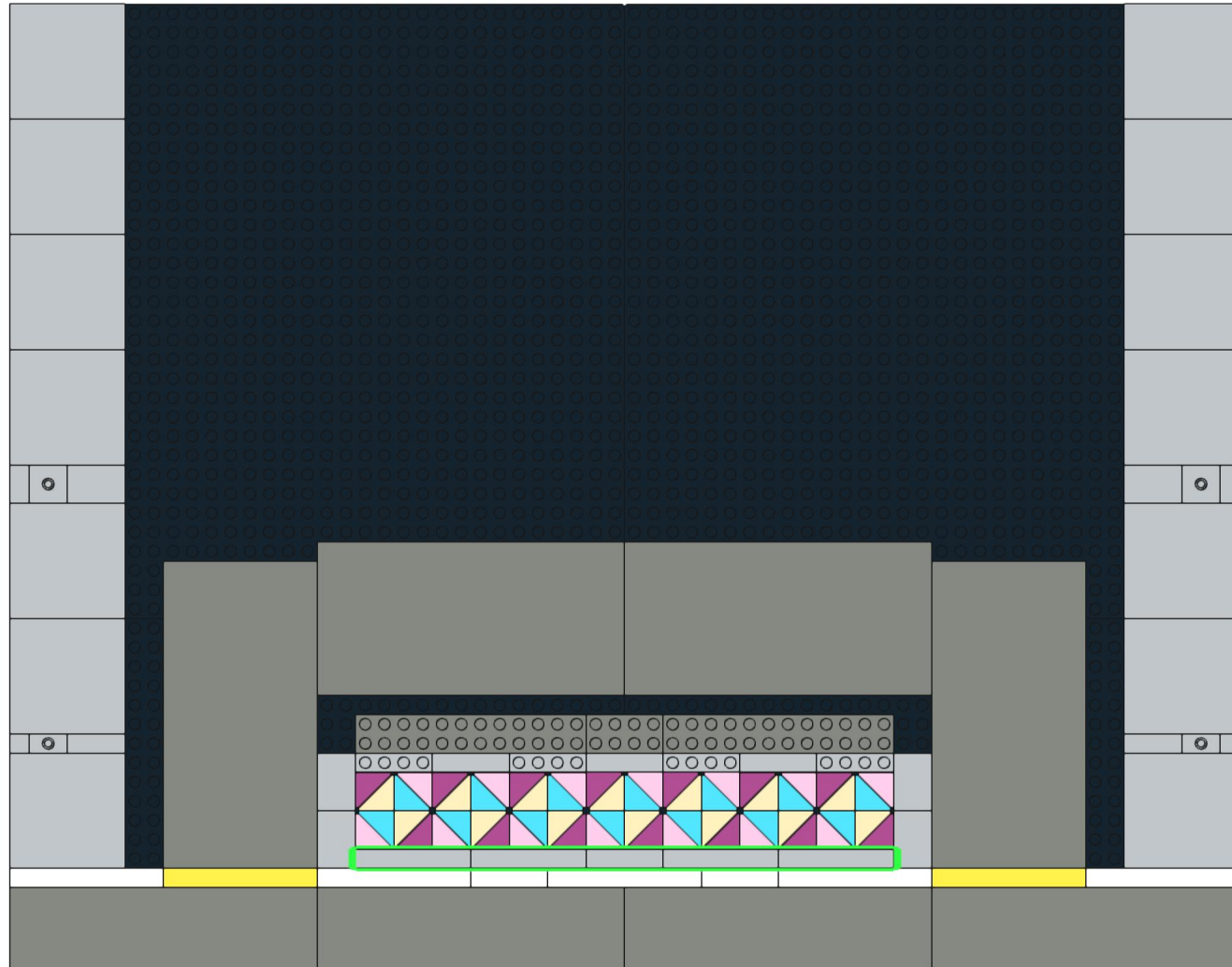

# 121



2x

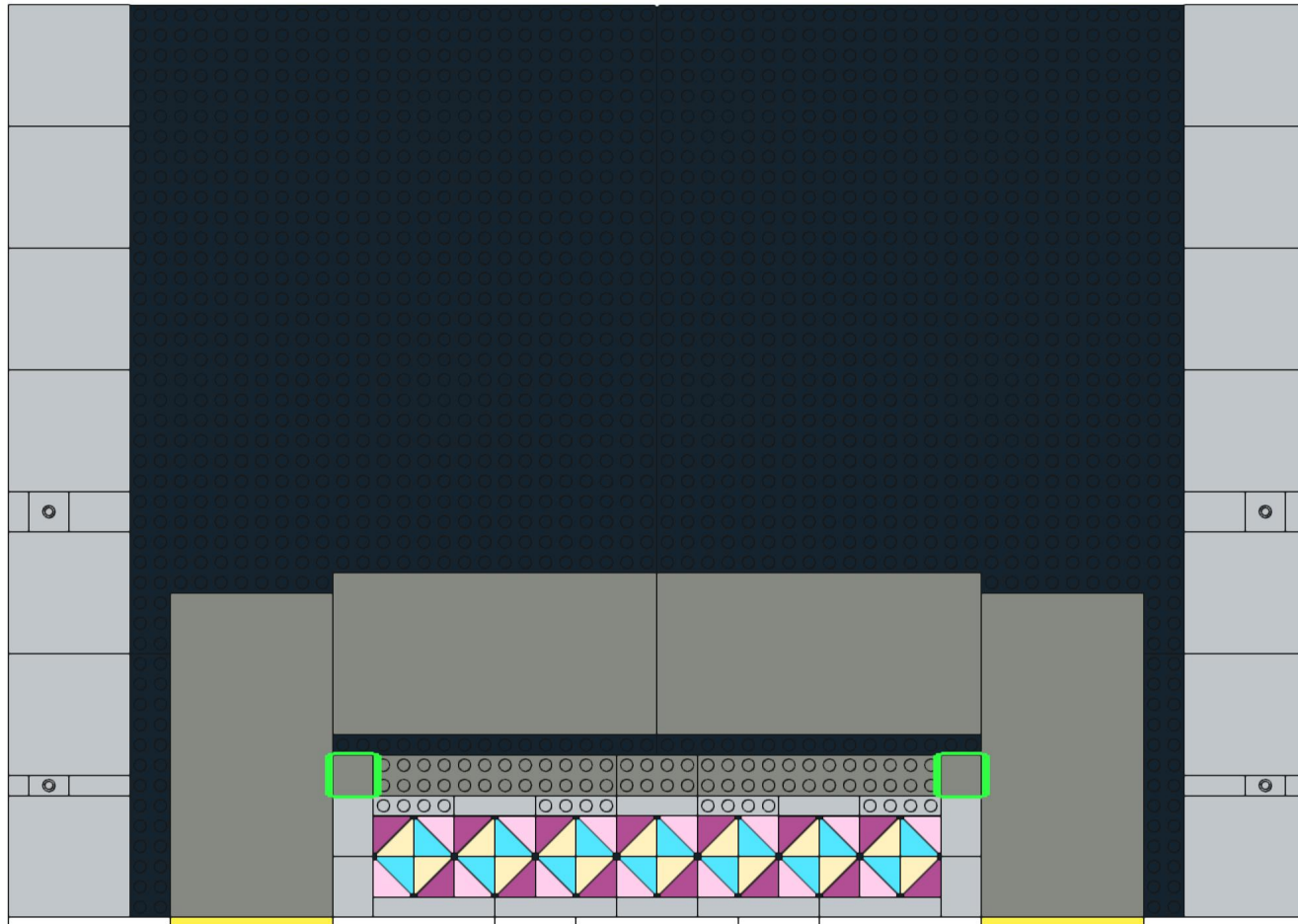

# 122

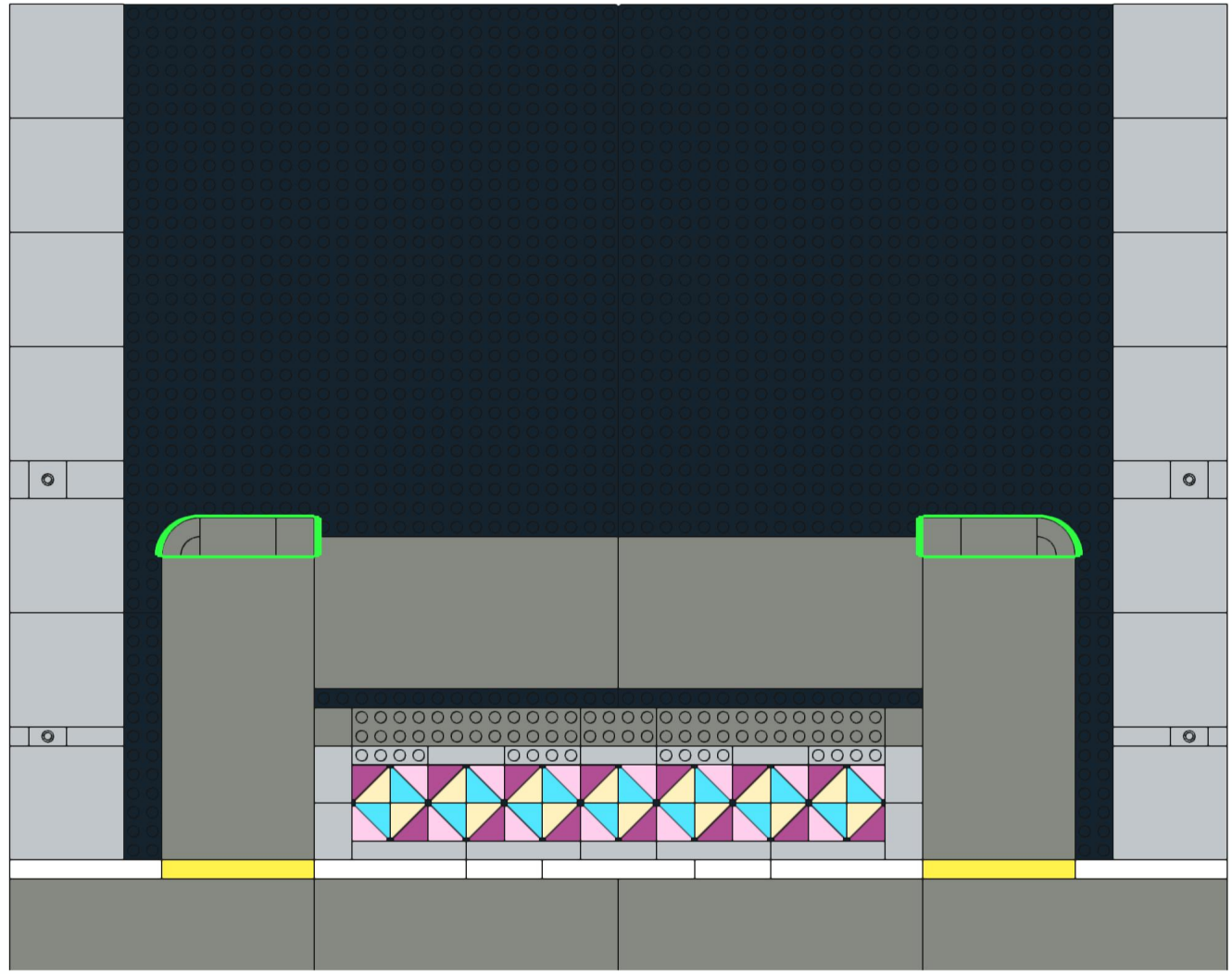
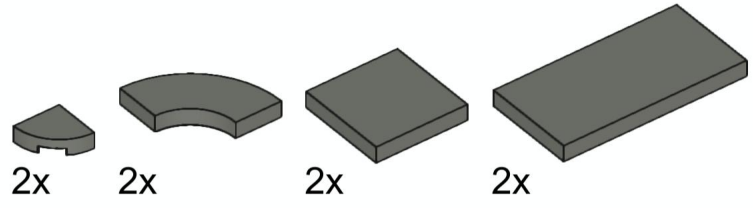

# 123

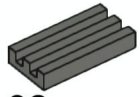

32x

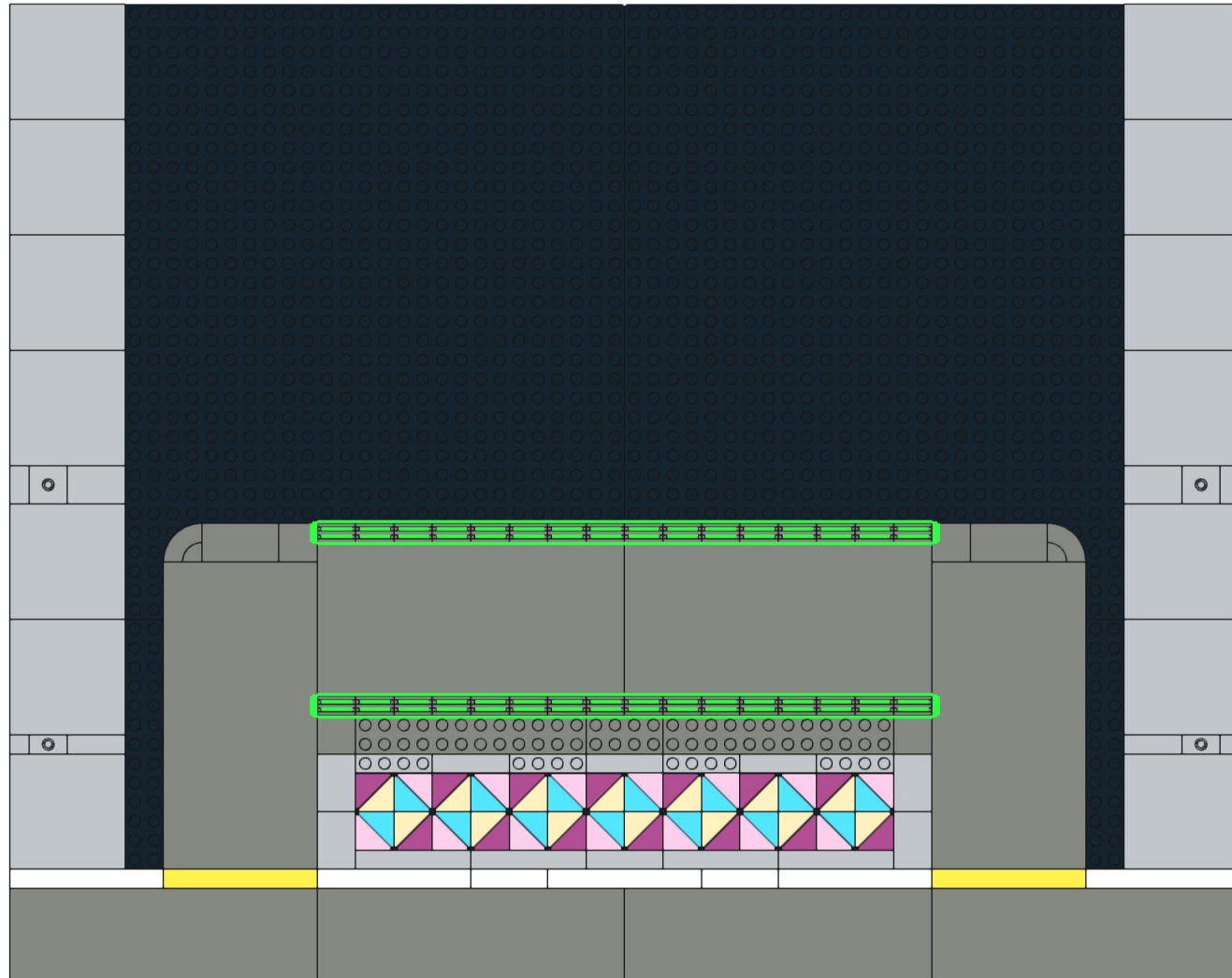

# 124

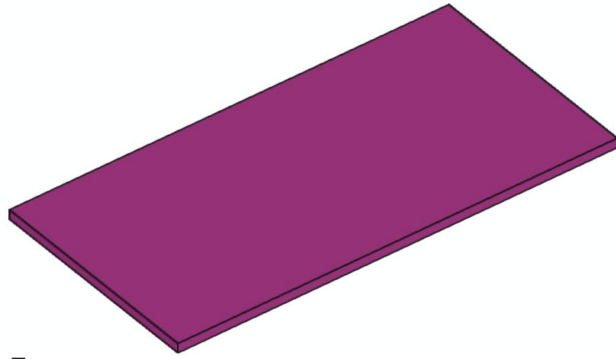

5x

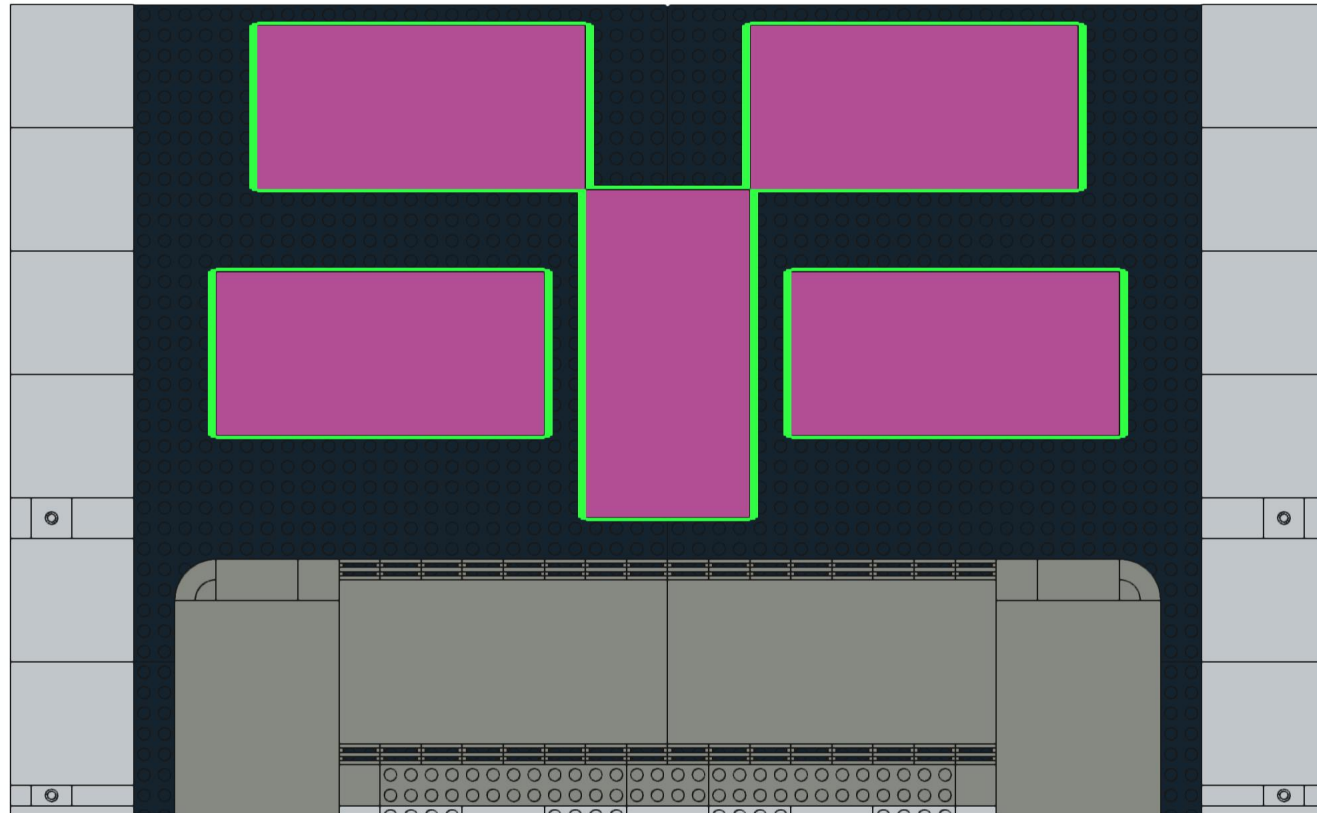

# 125

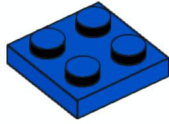

10x

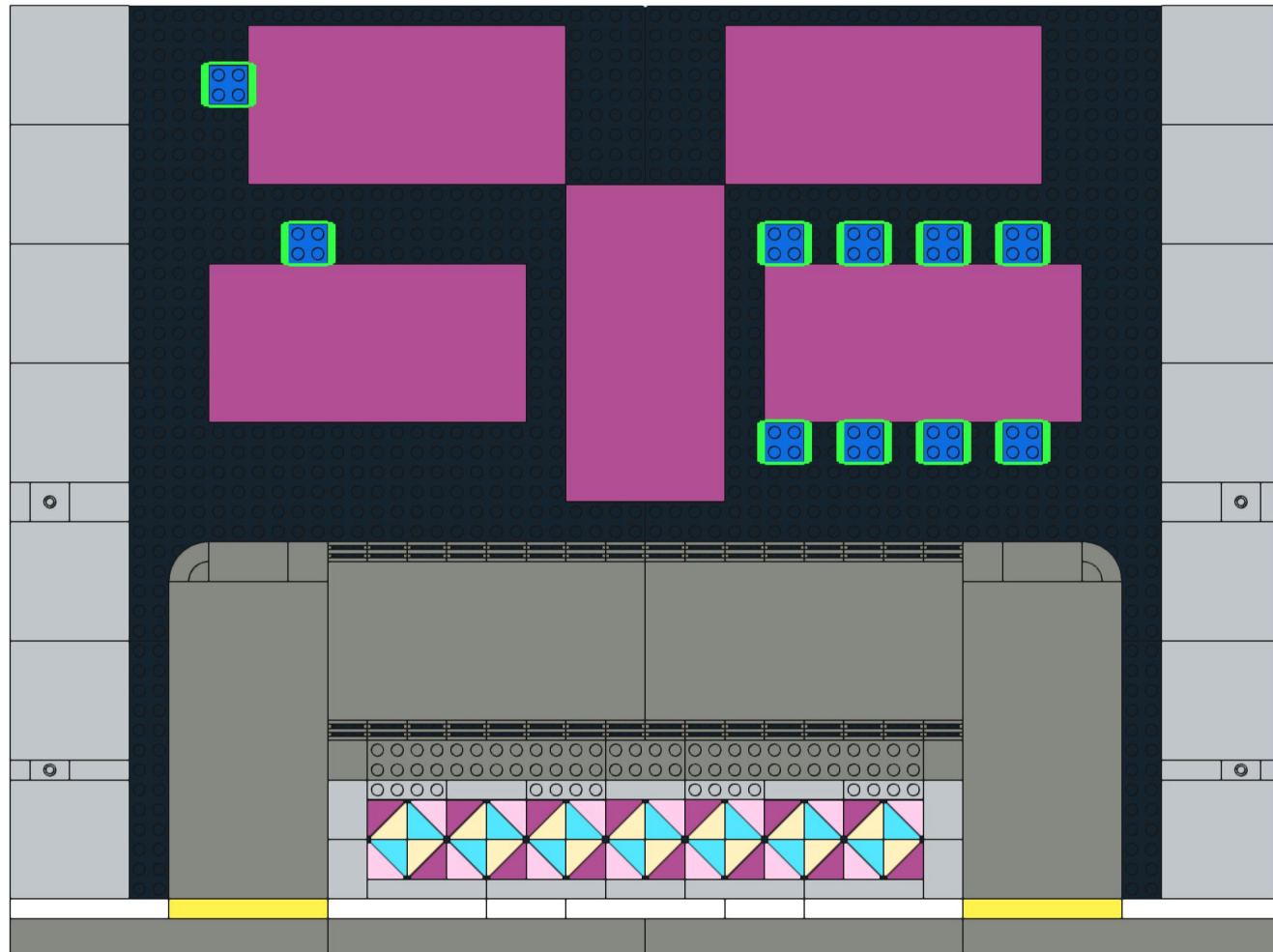

# 126

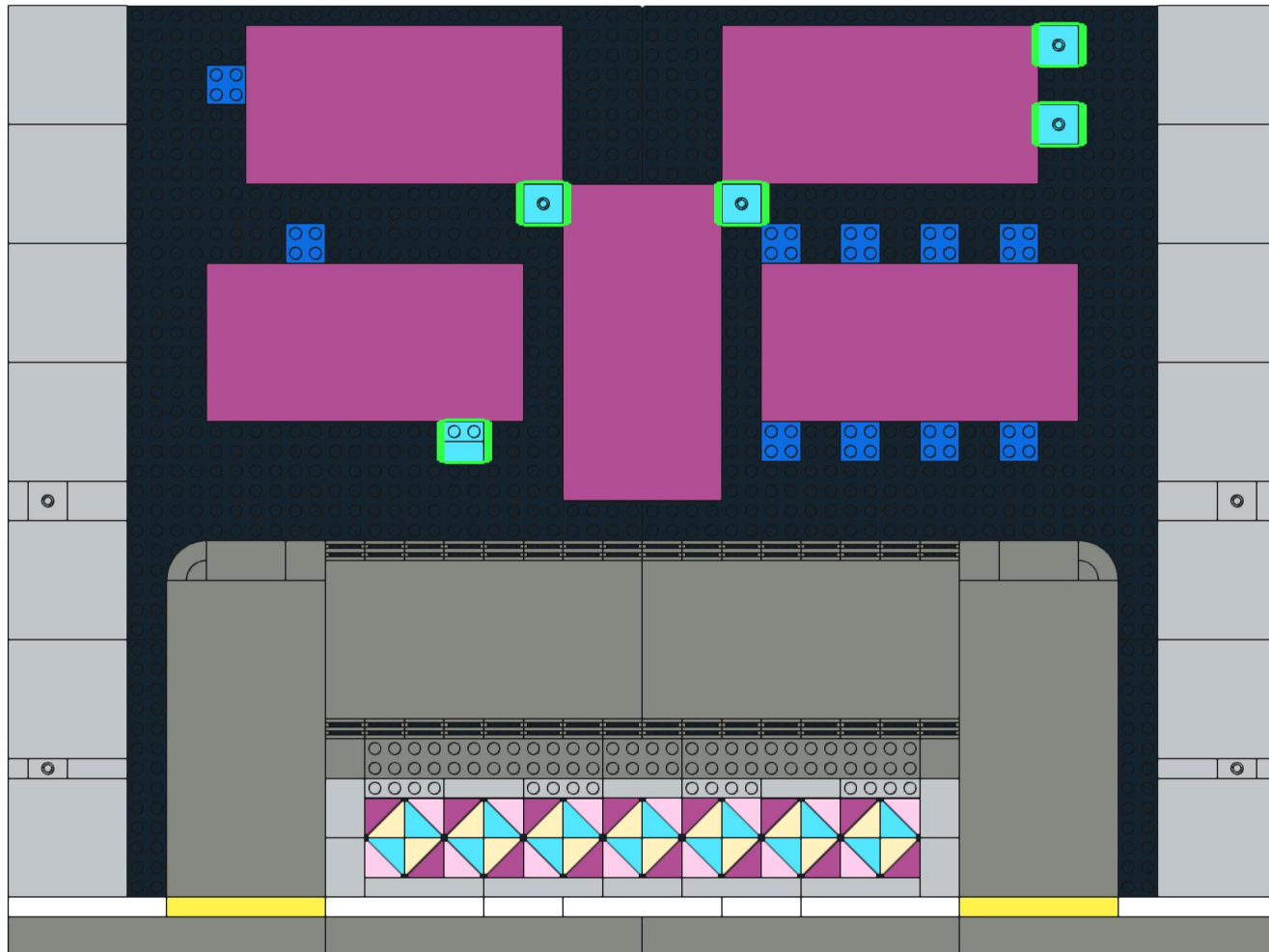
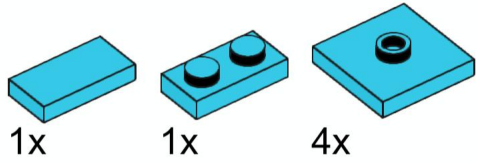

# 127

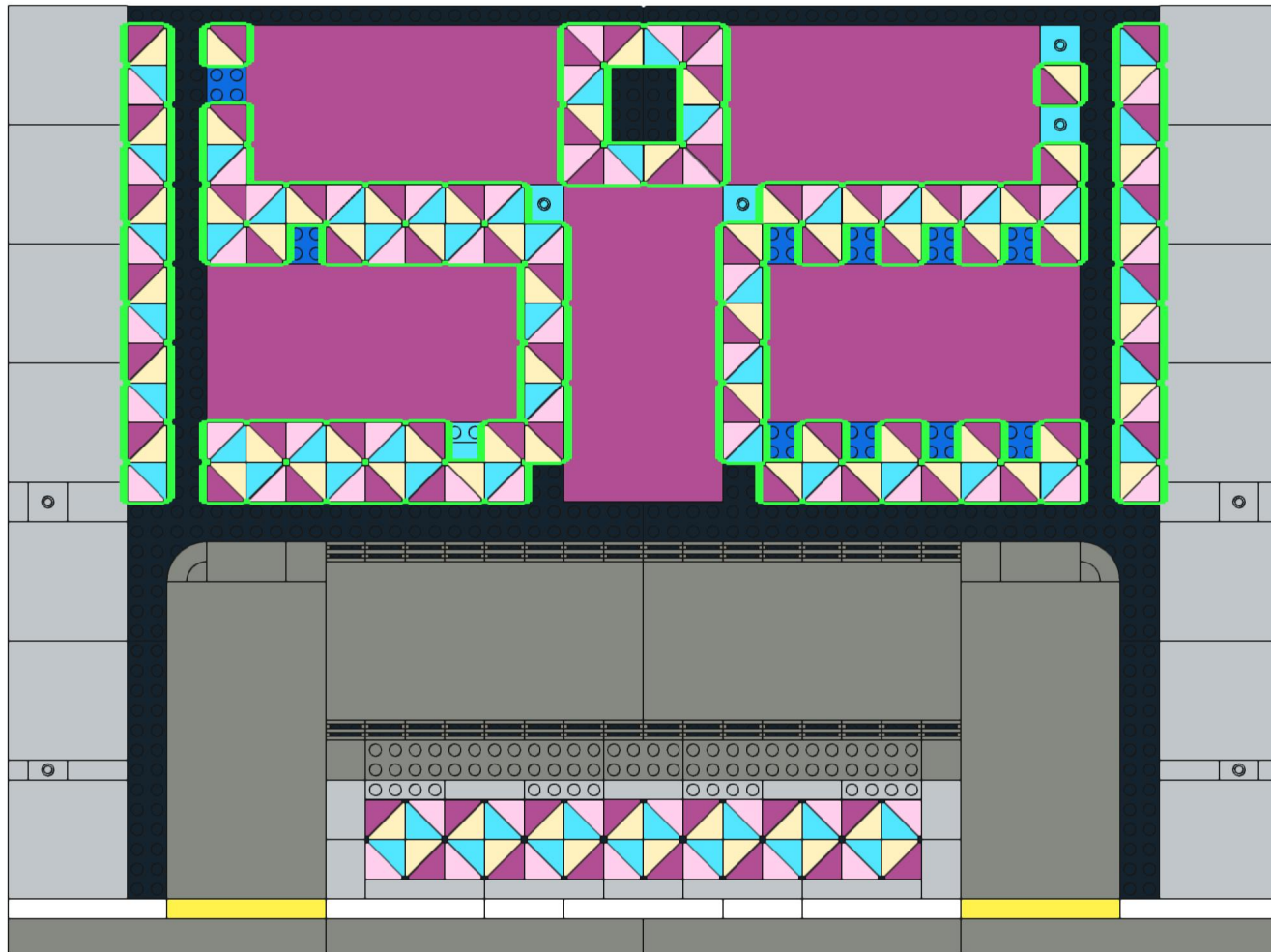
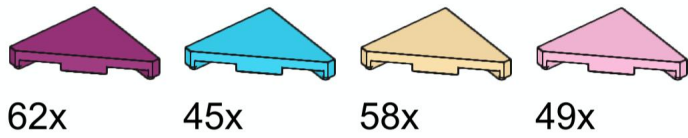



# 128

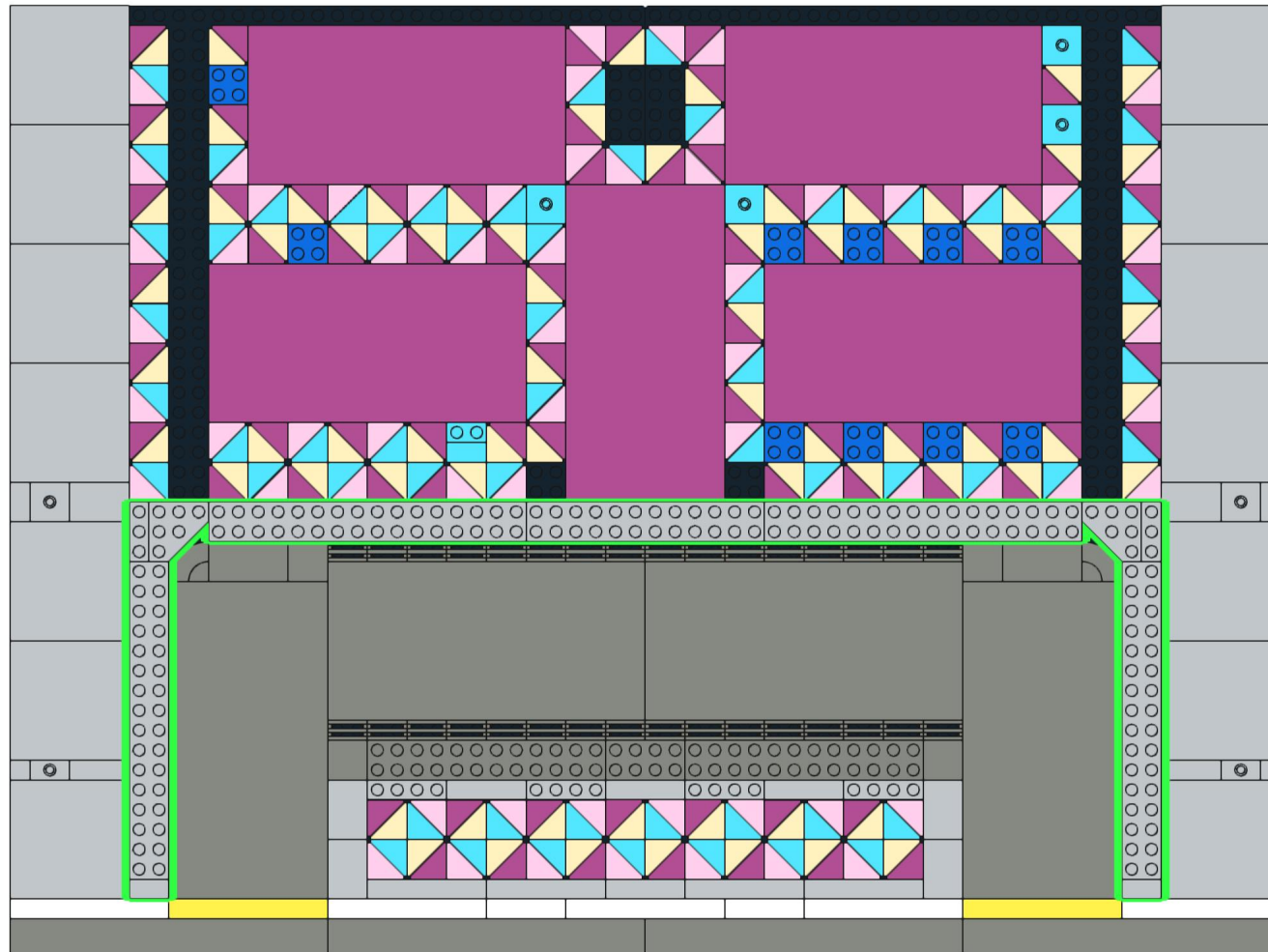
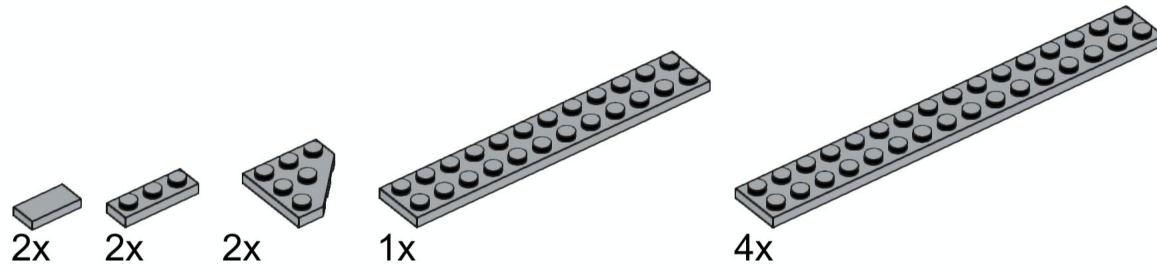

# 129

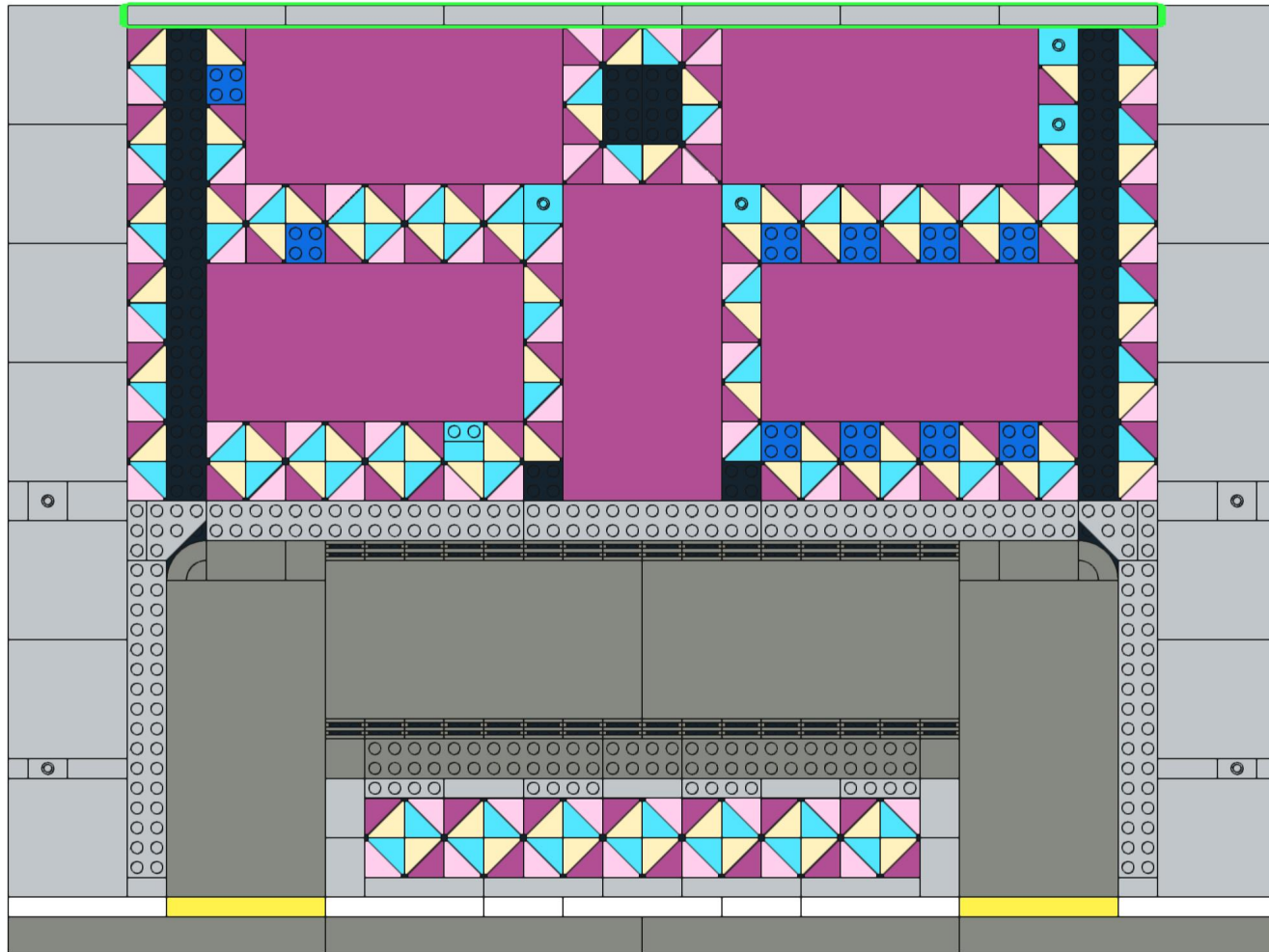
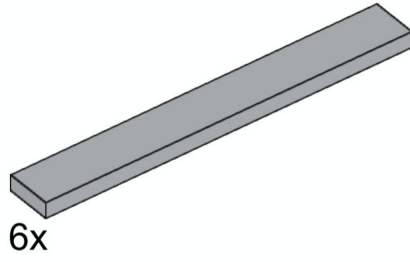
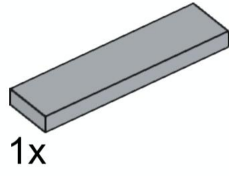

# 130

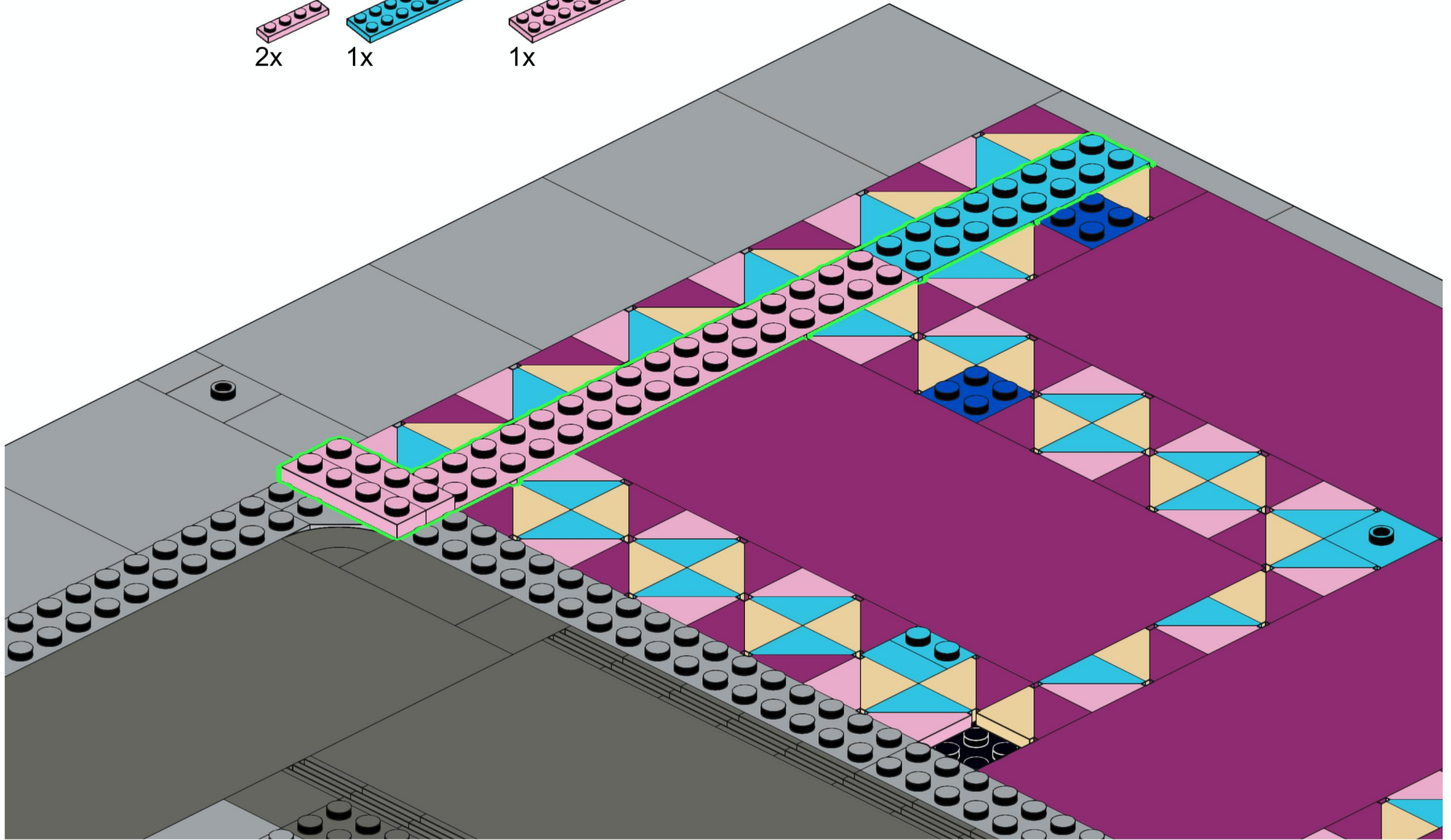
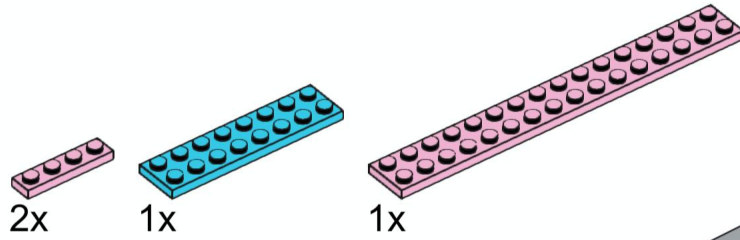

# 131

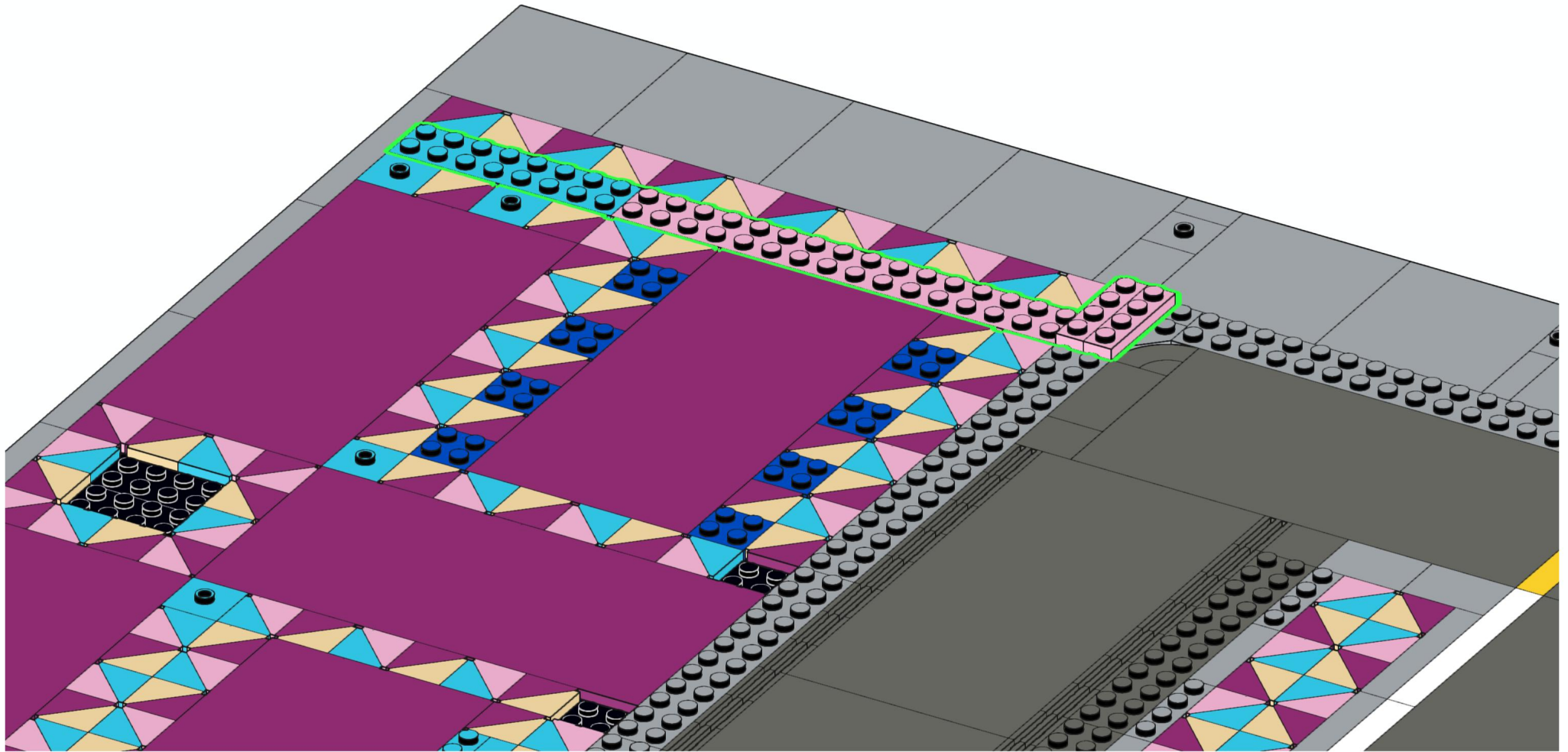
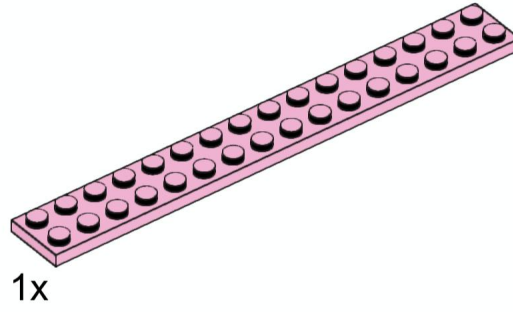
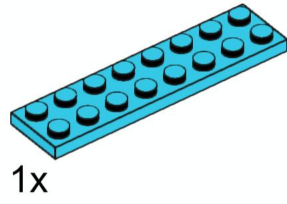
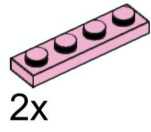

# 132



11x

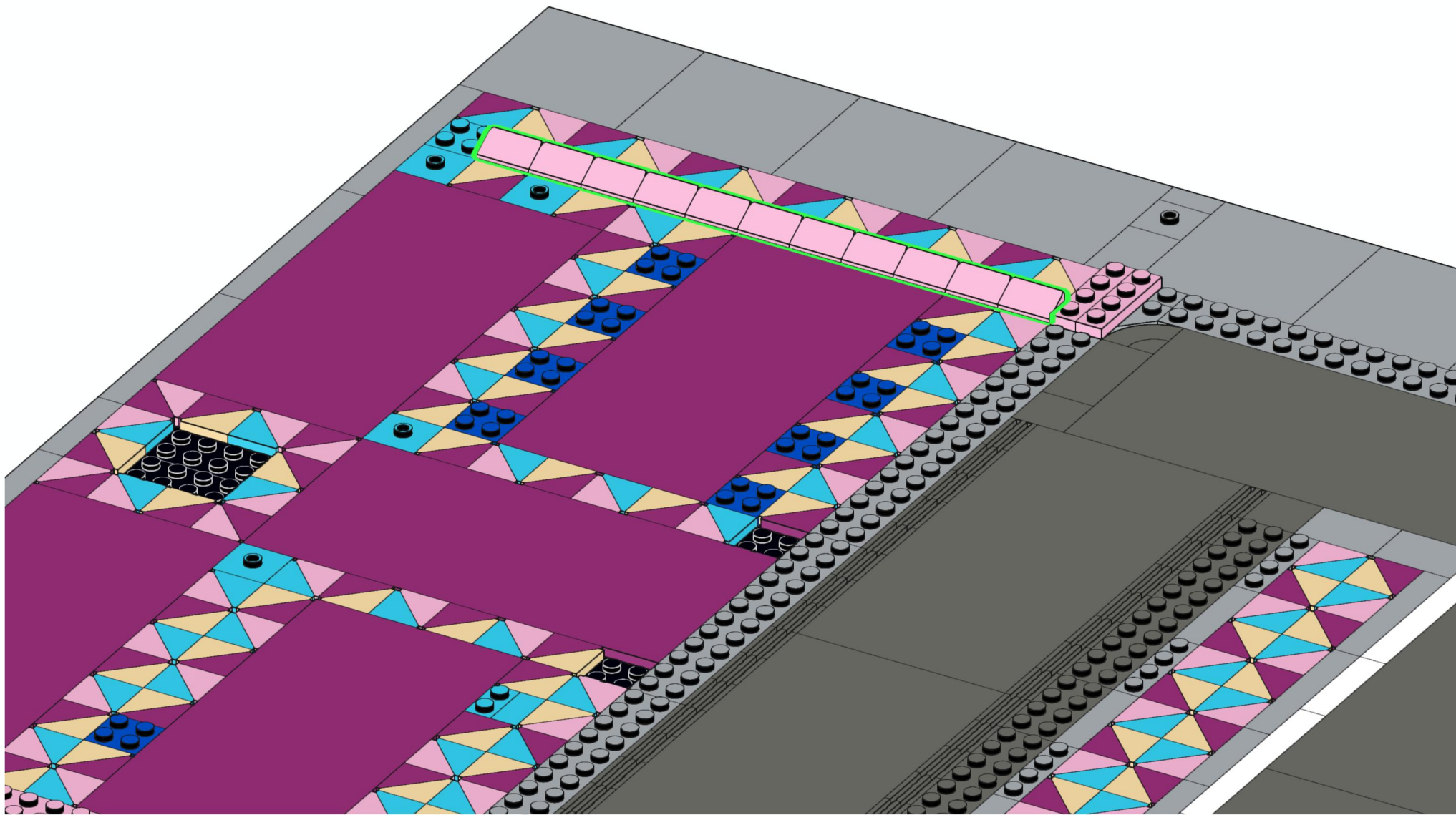

# 133

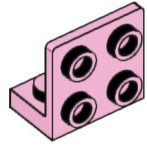

12x

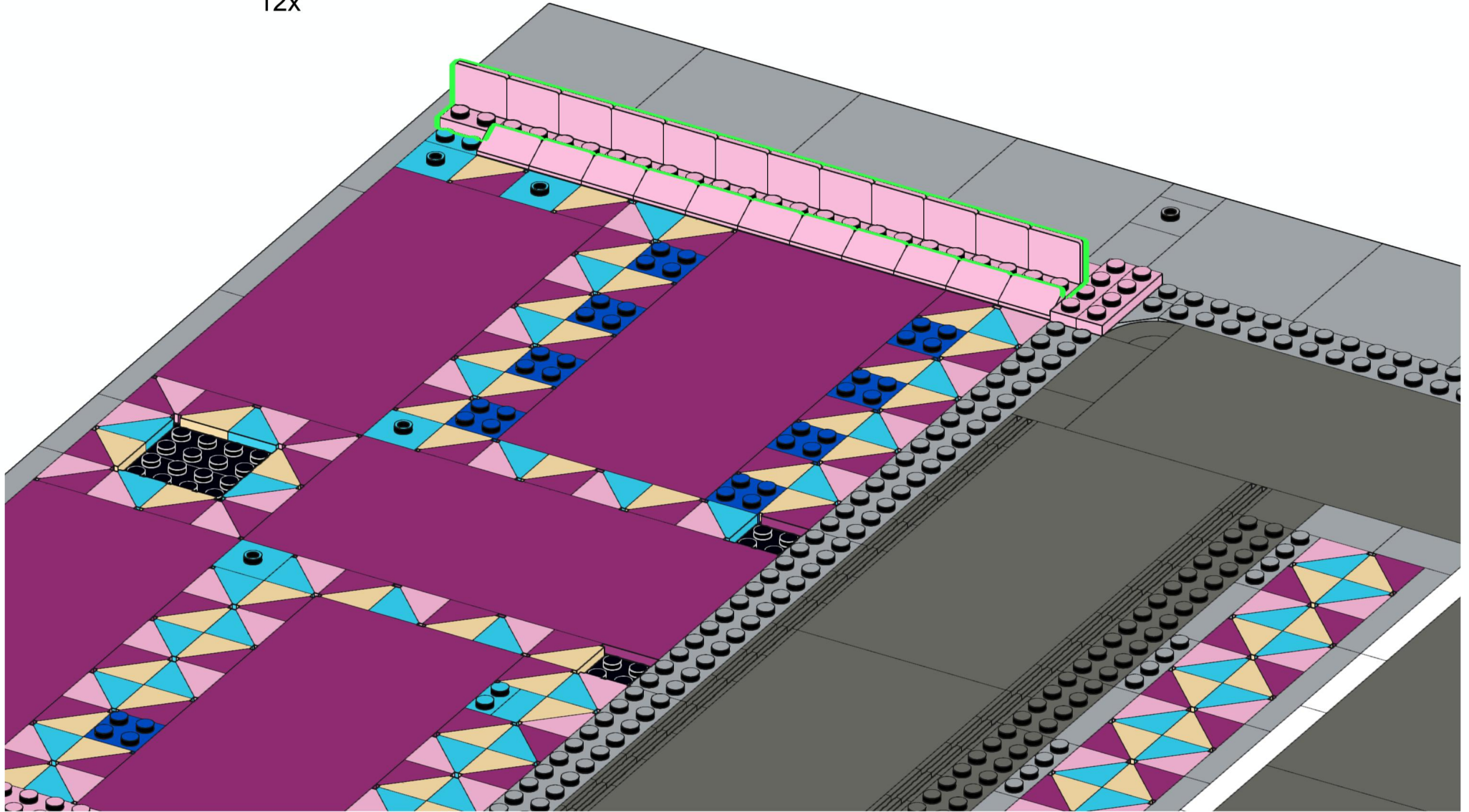

# 134

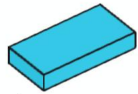

1x

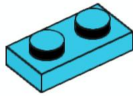

2x

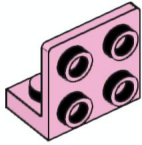

1x

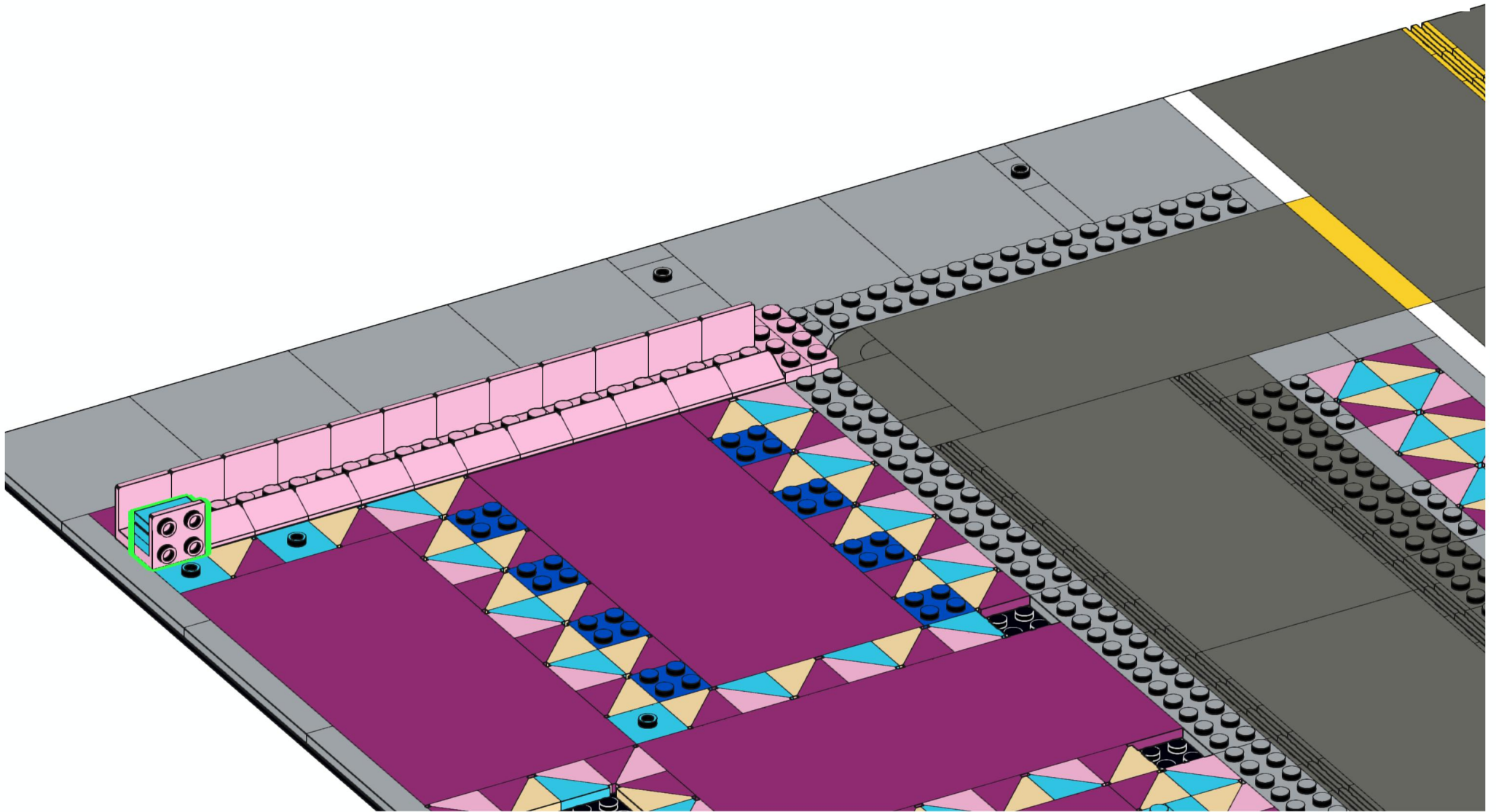

# 135

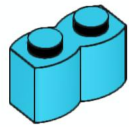

12x

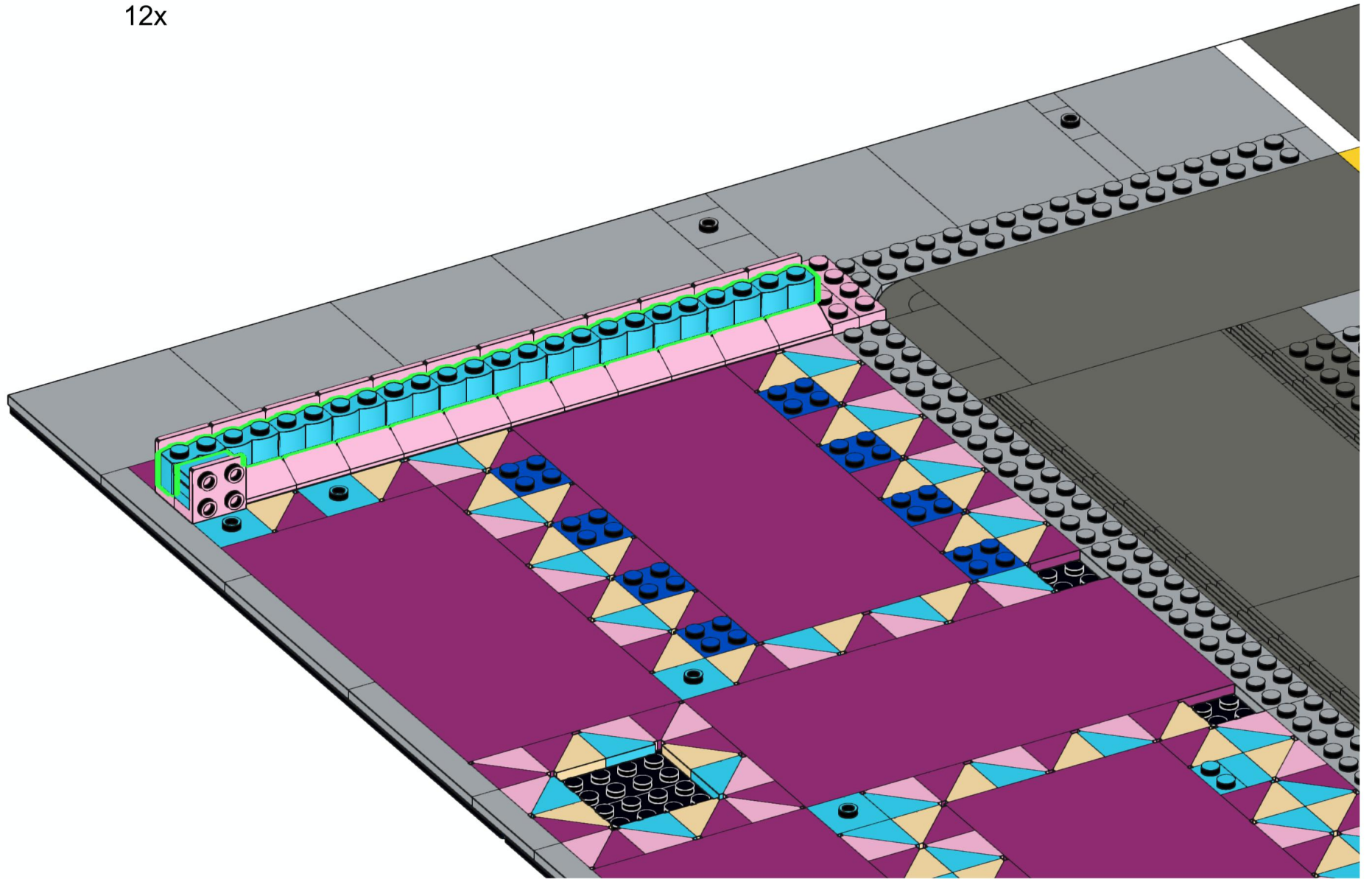



# 136



11x

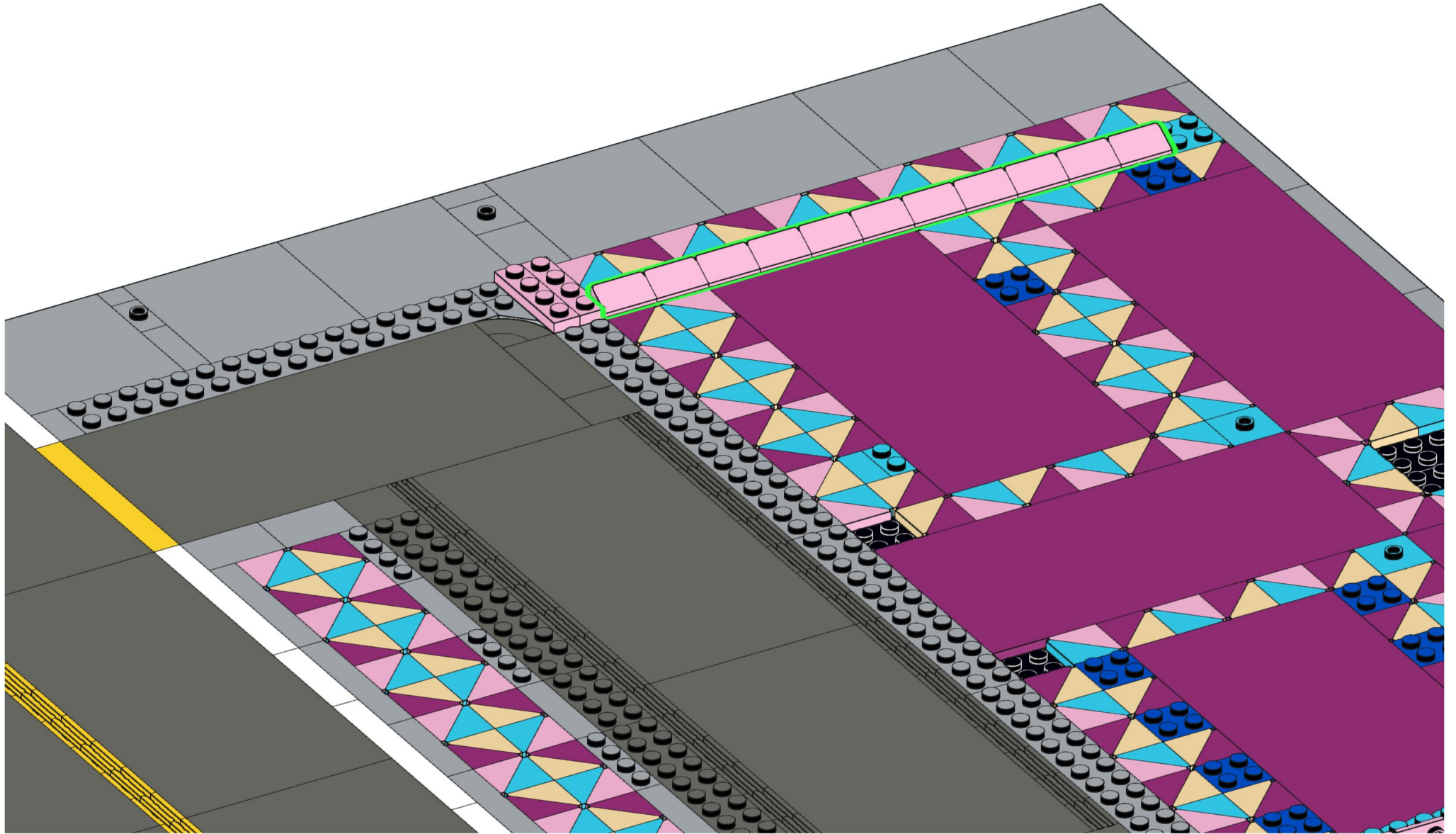

# 137

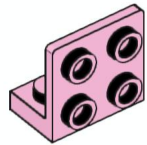

12x

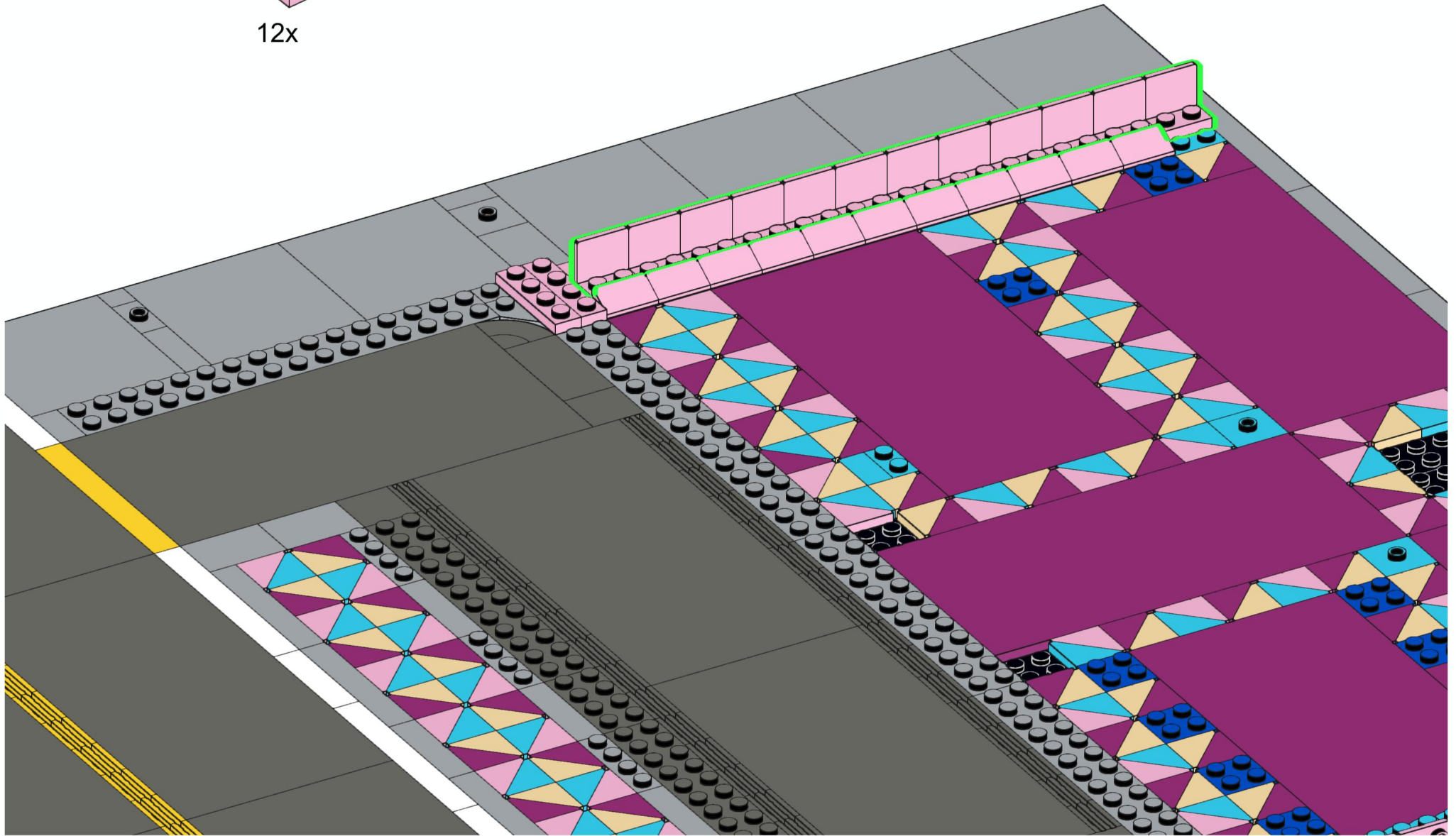

# 138

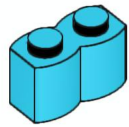

12x

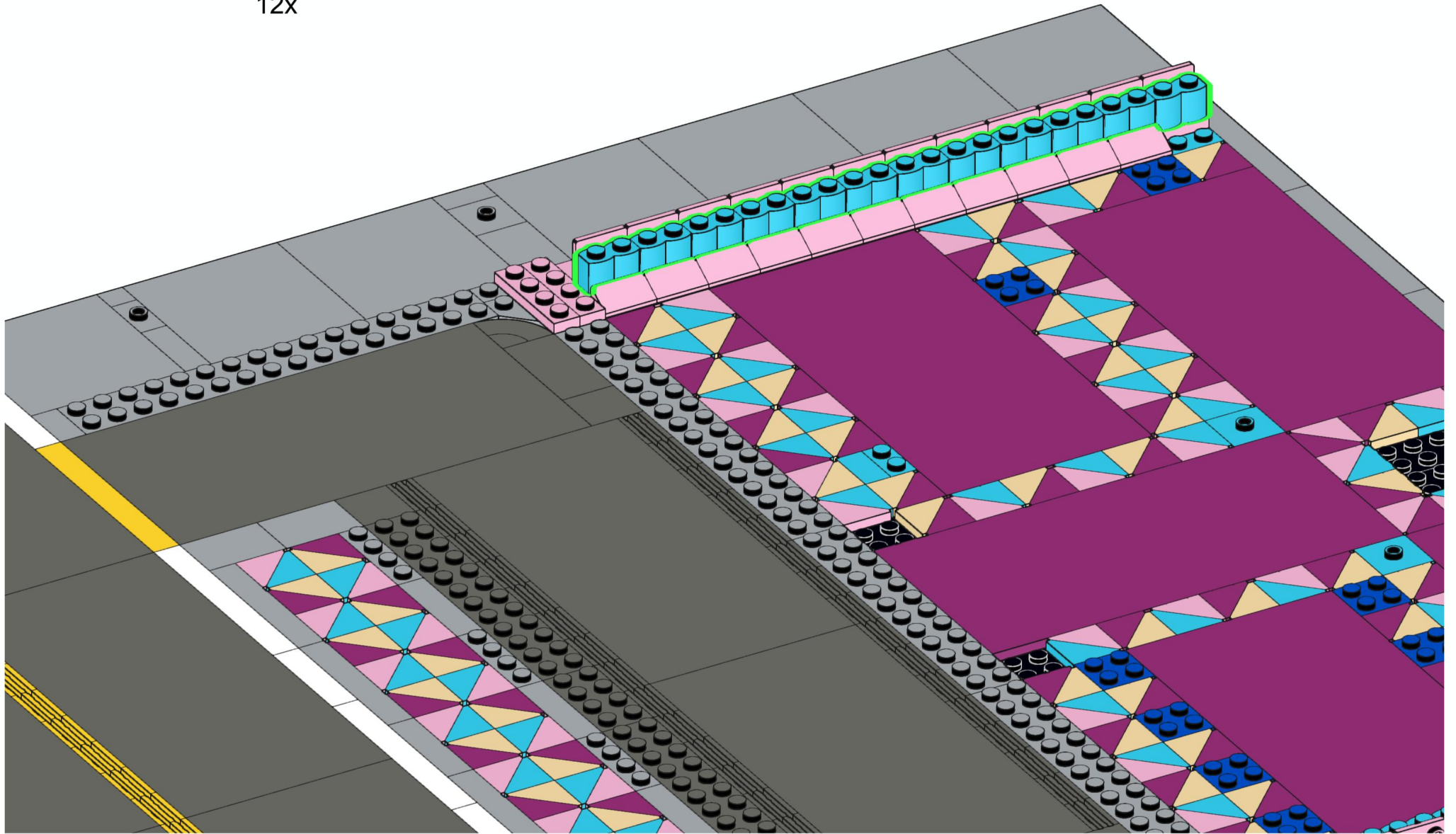

# 139

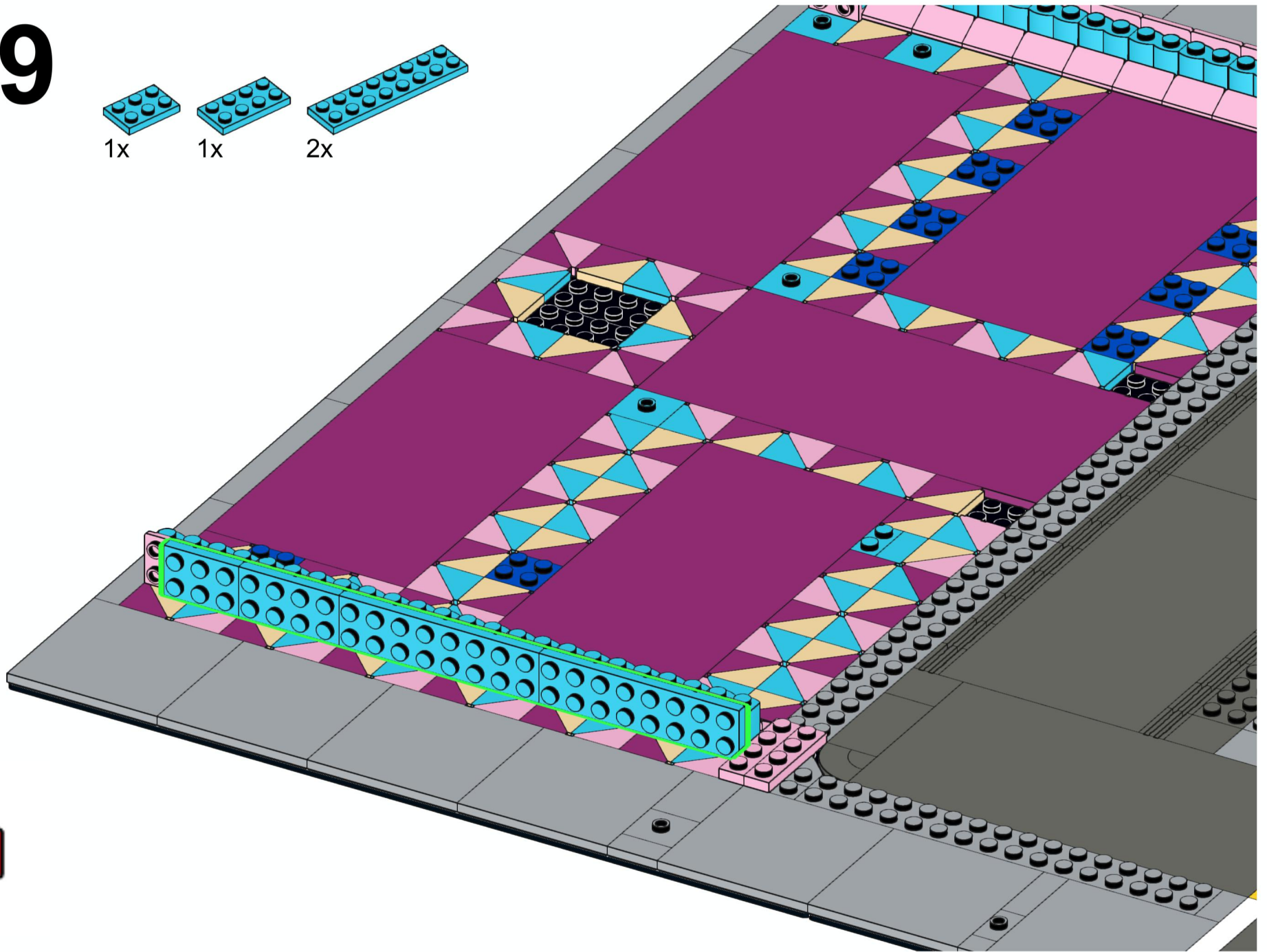
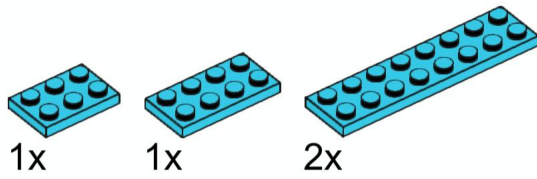

# 140



6x



5x

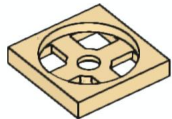

8x

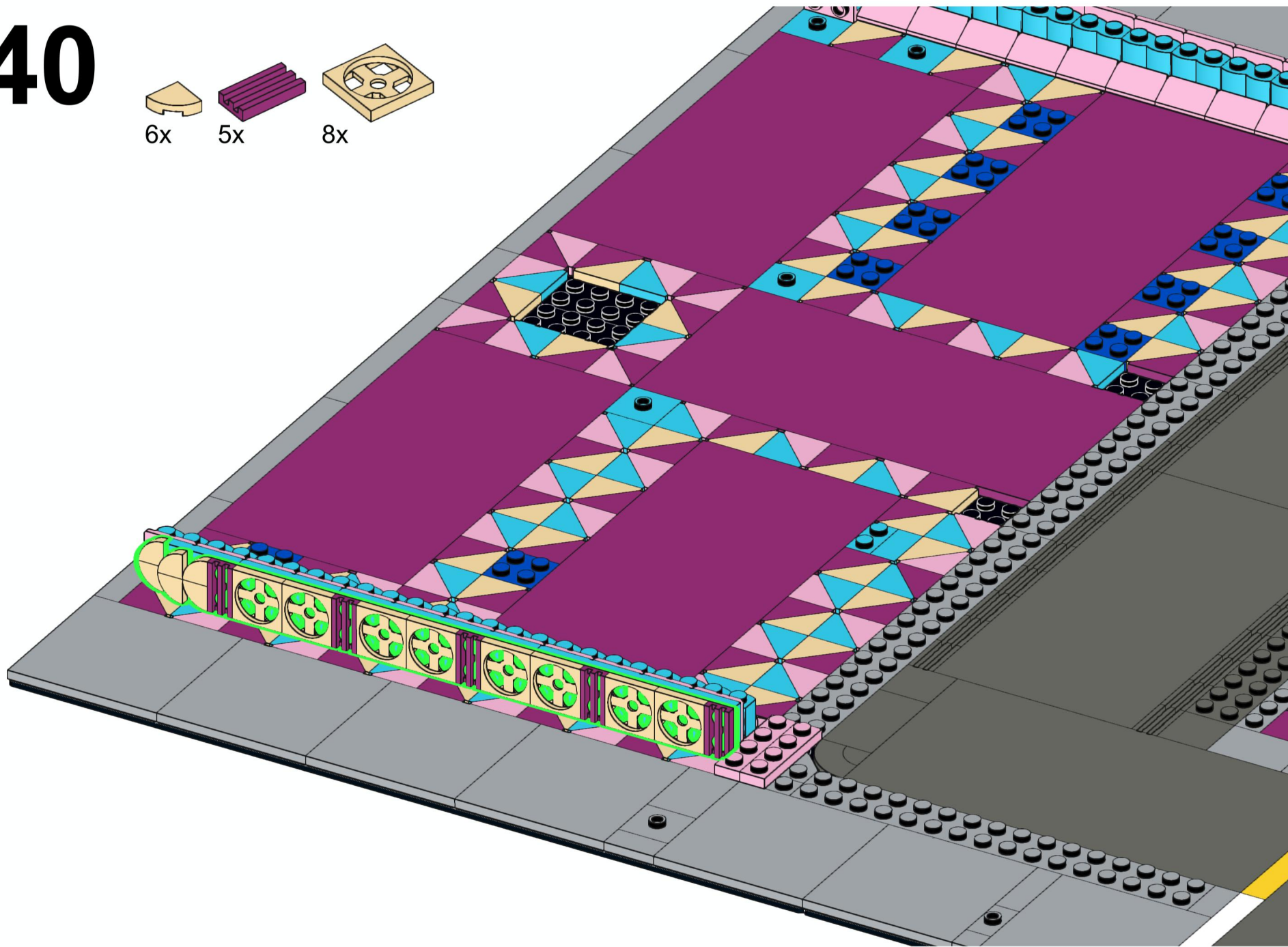

# 141

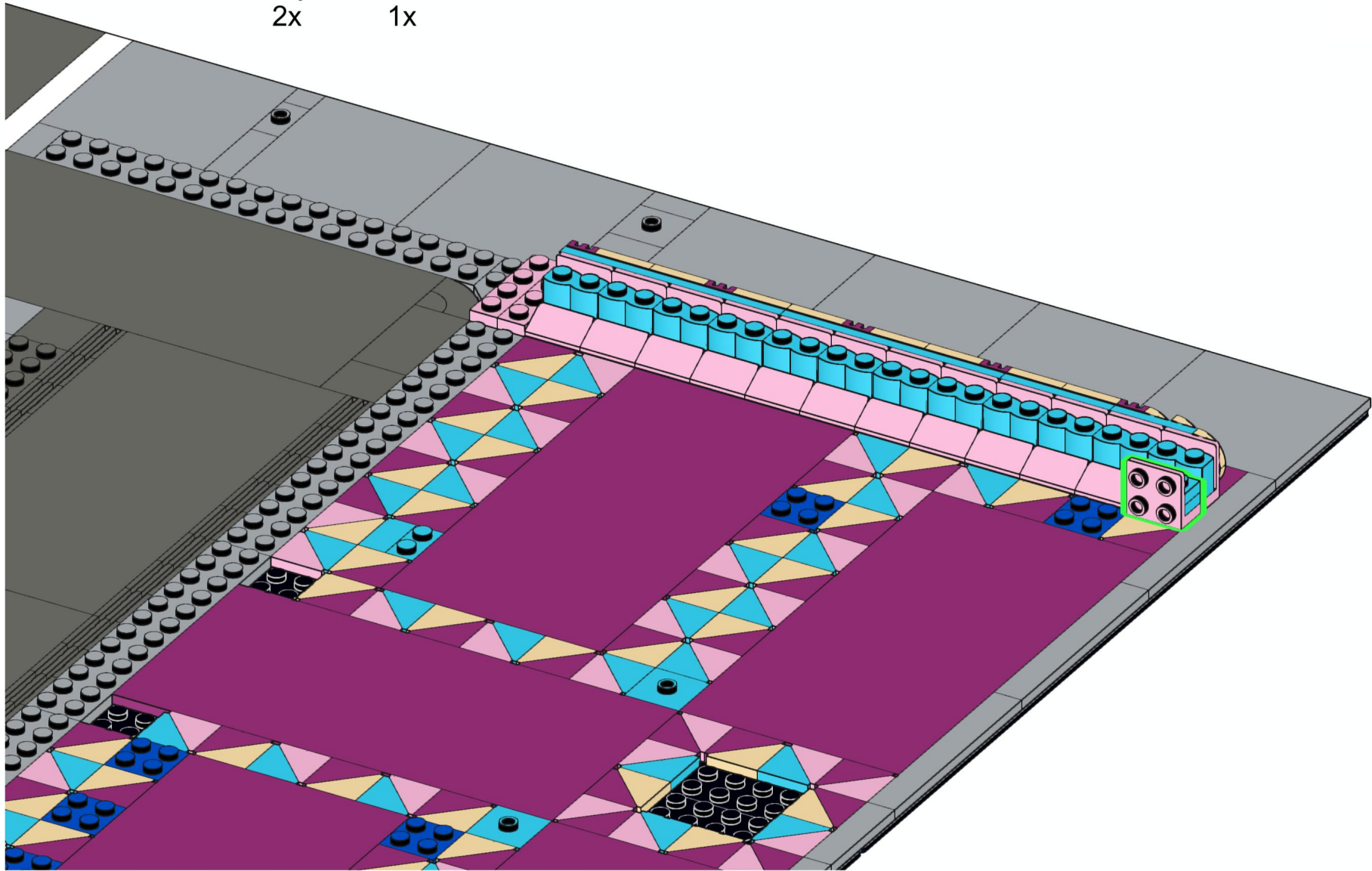
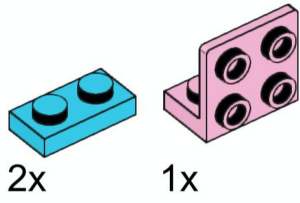

# 142

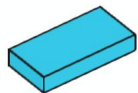

1x

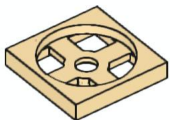

1x

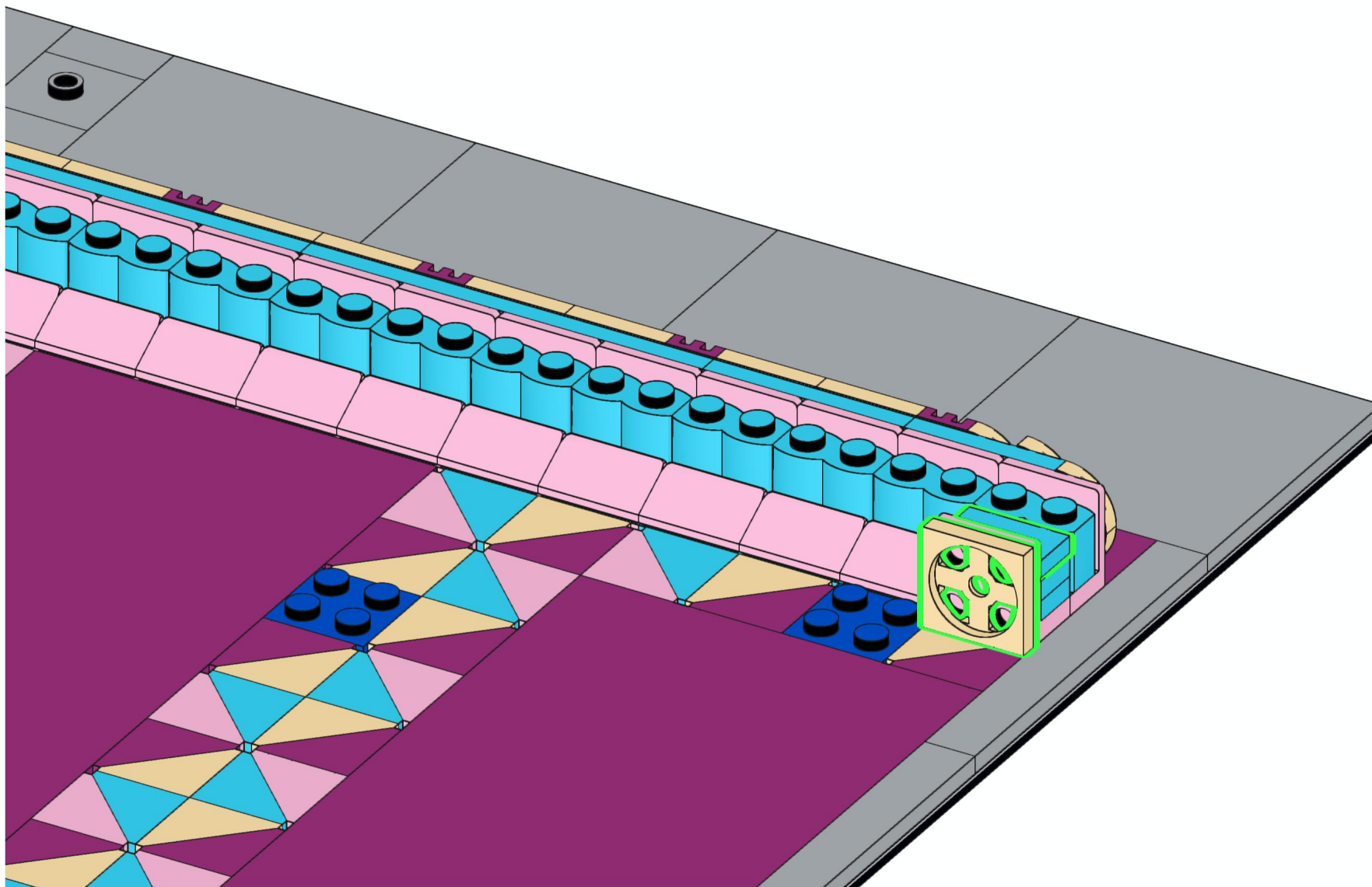

# 143

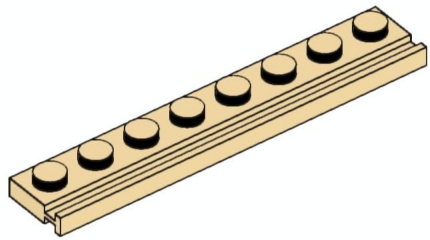

3x

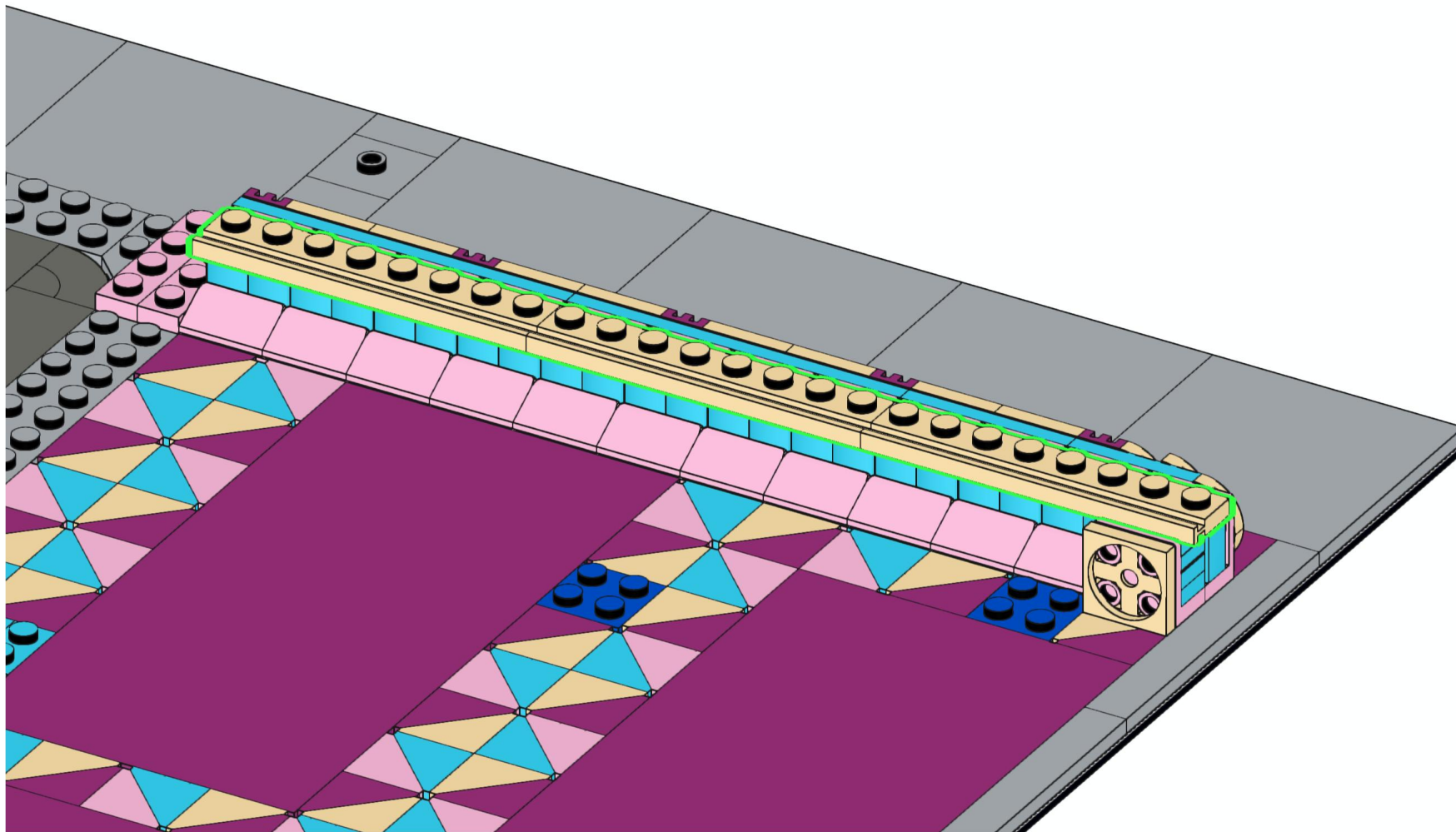



# 144

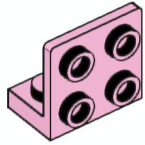

16x

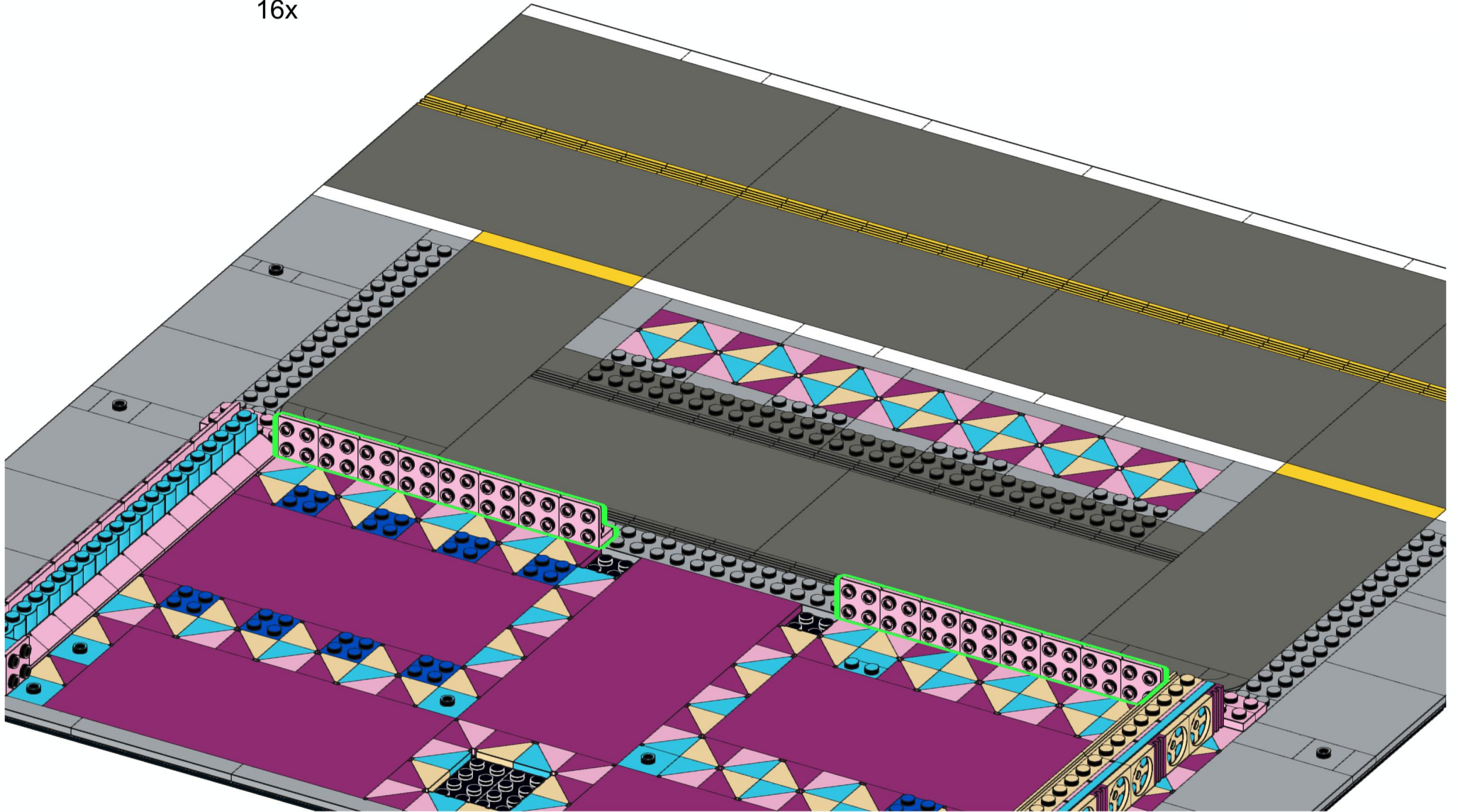

# 145

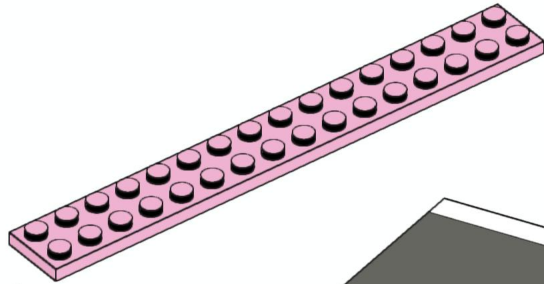

2x

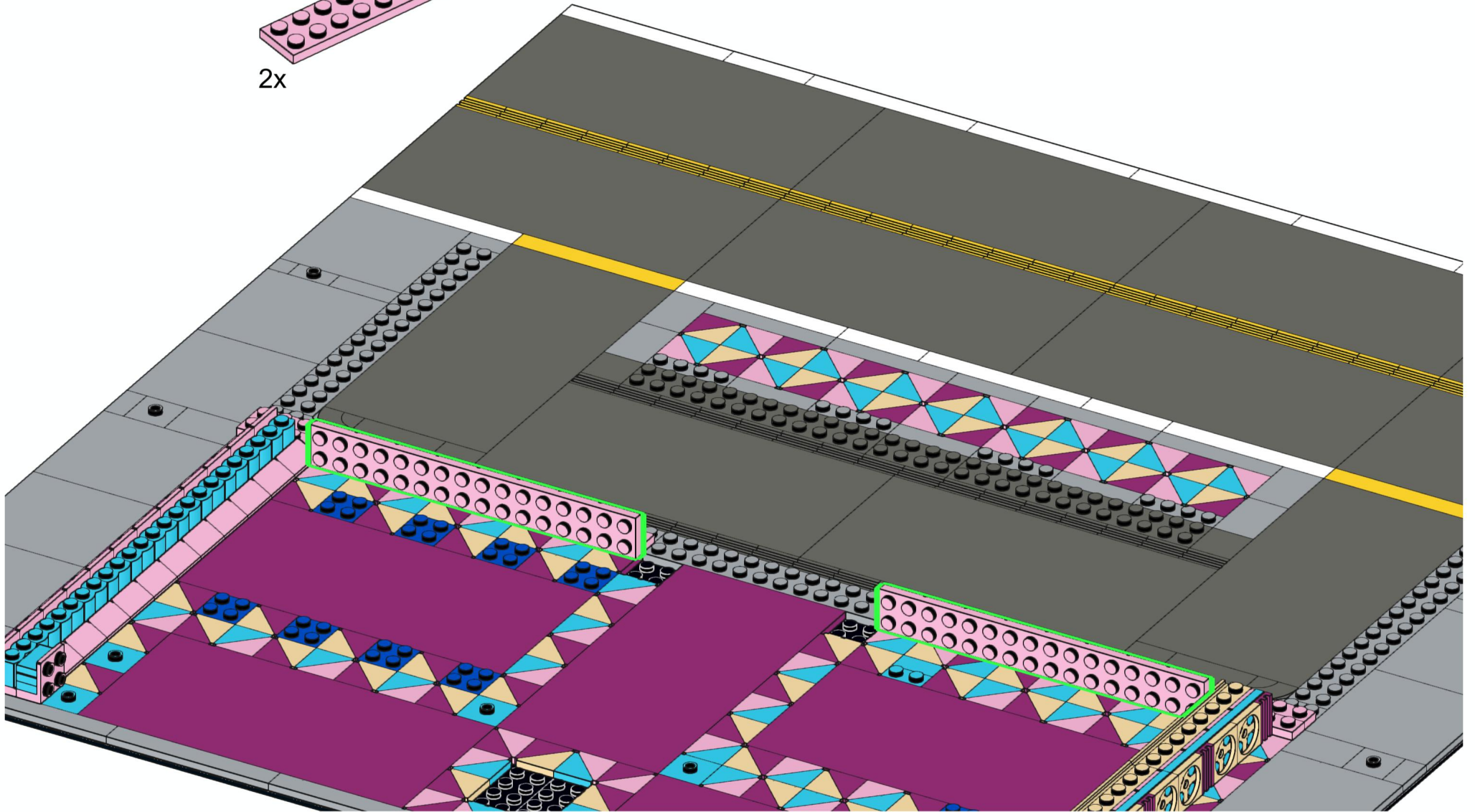

# 146

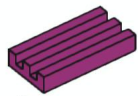

4x

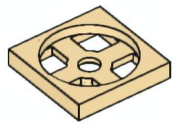

6x

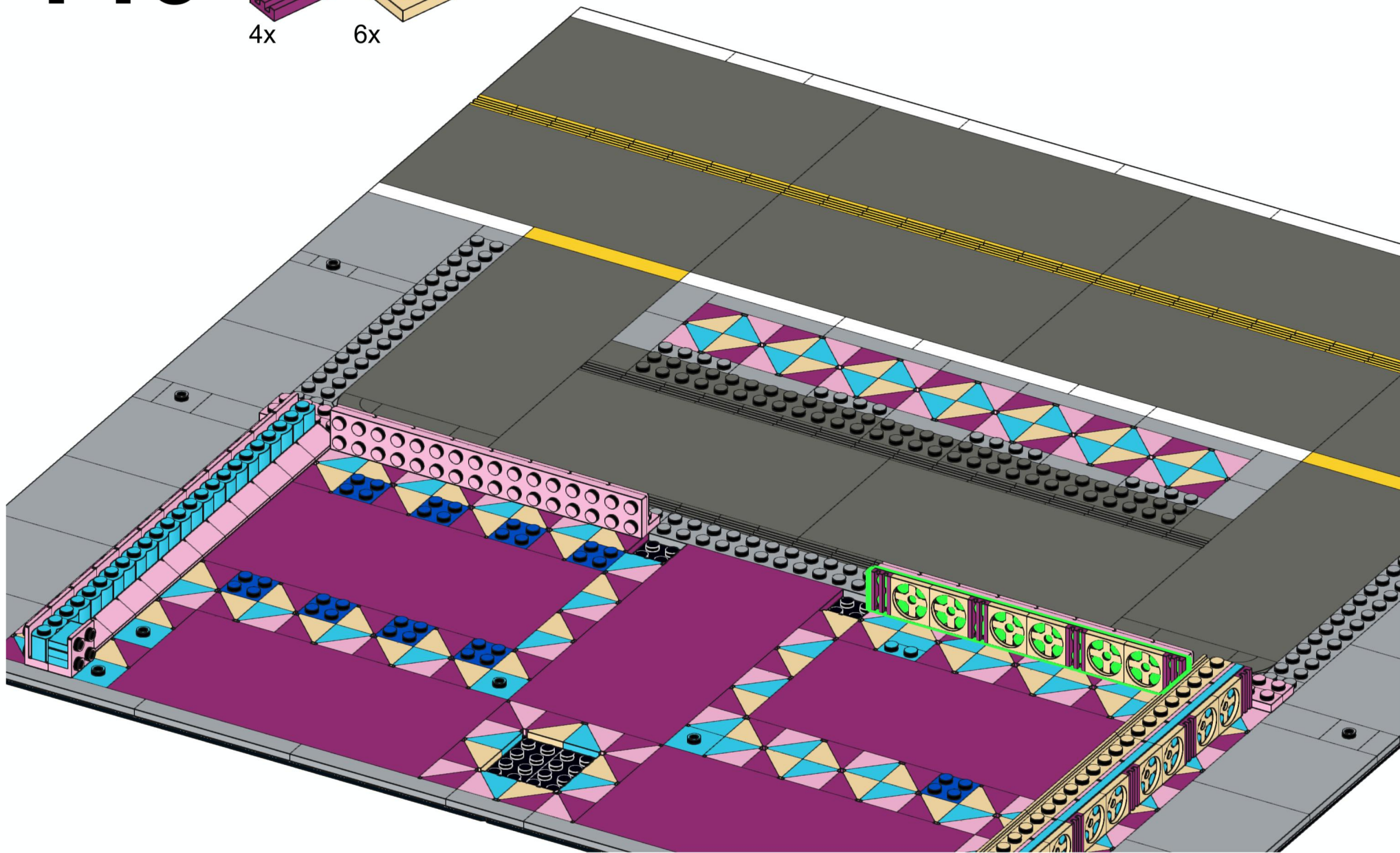

# 147

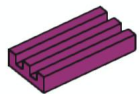

4x

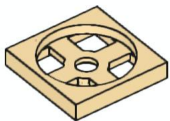

6x

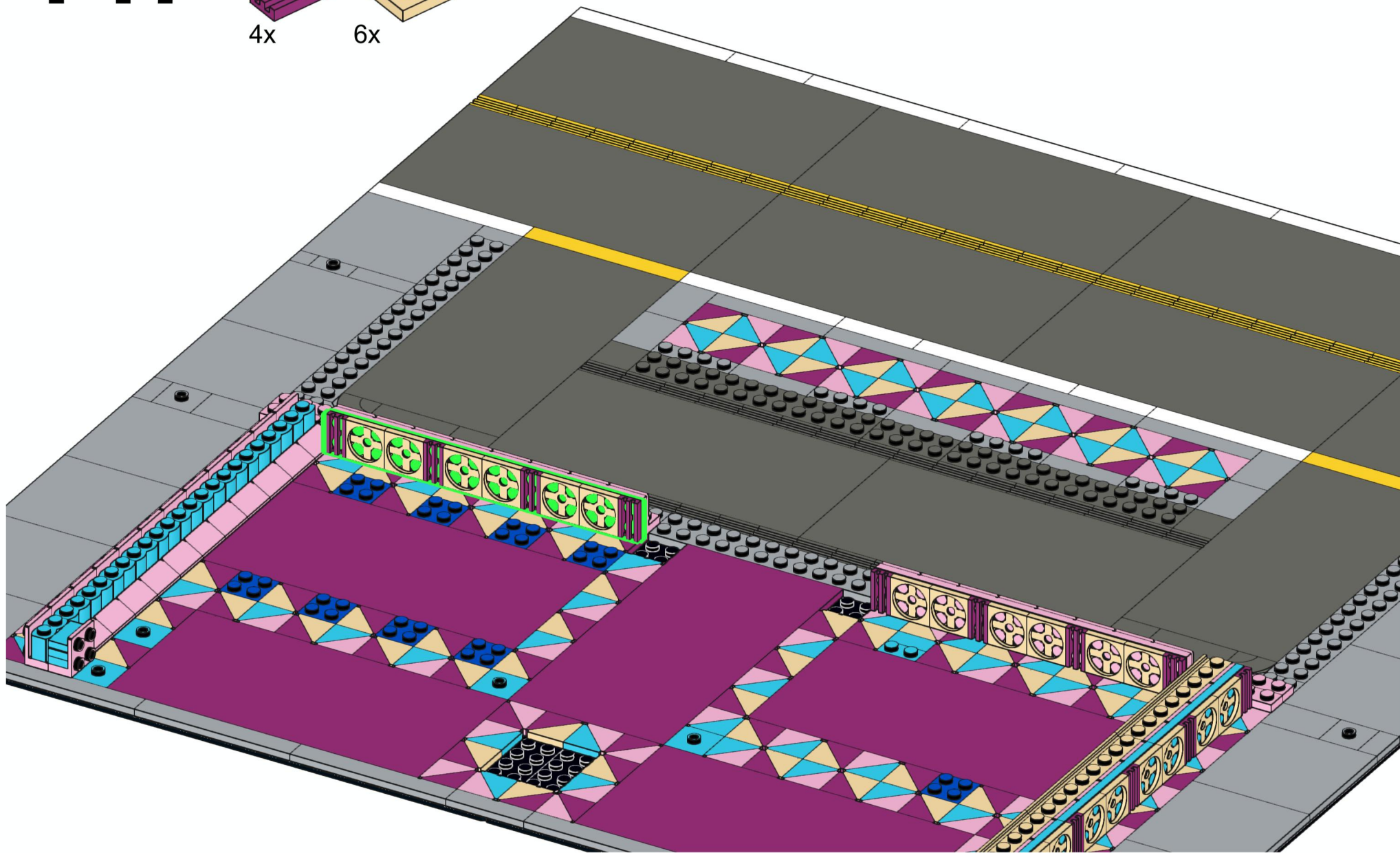

# 148

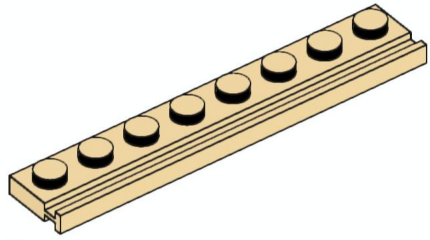

3x

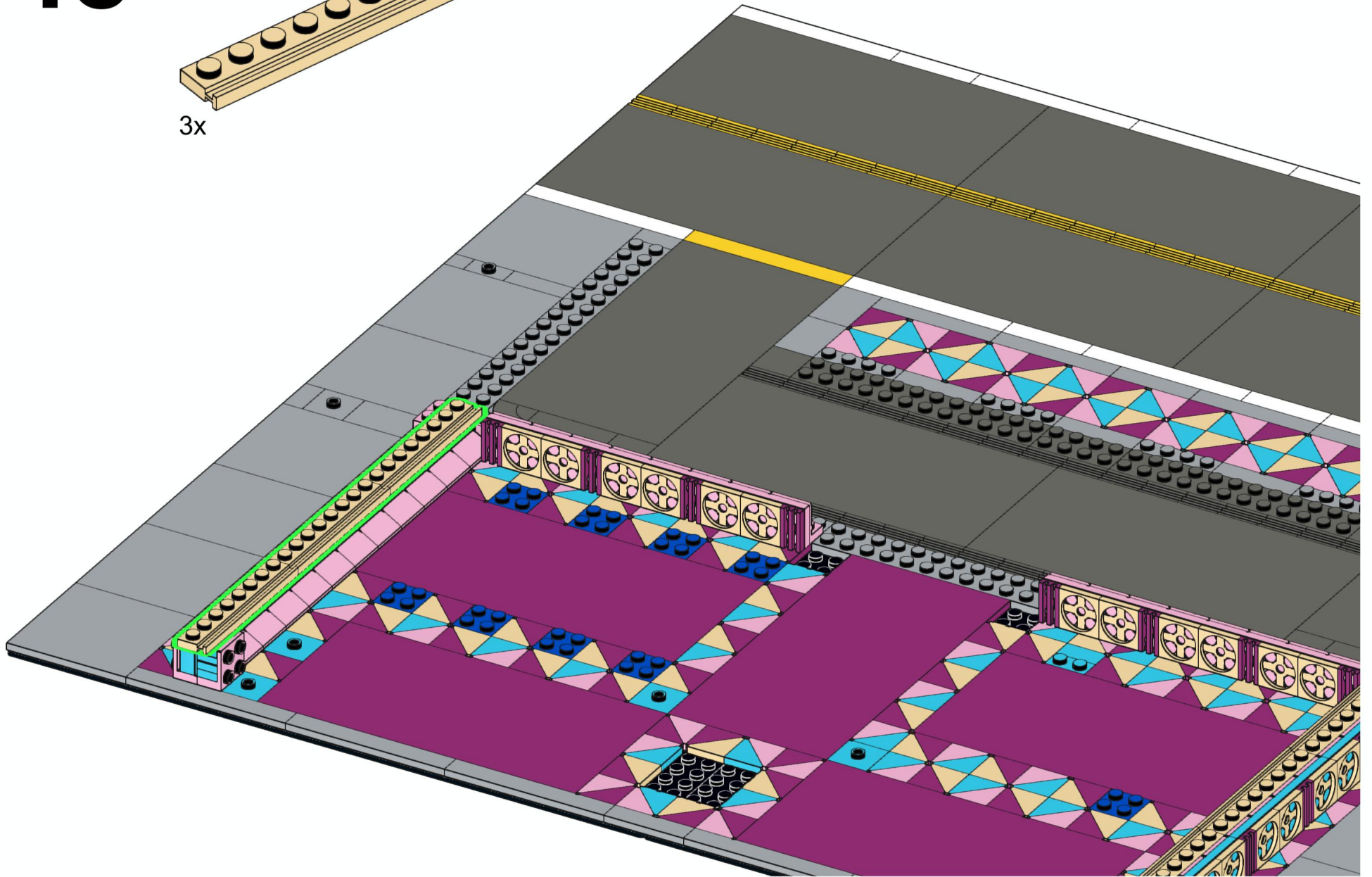

# 149

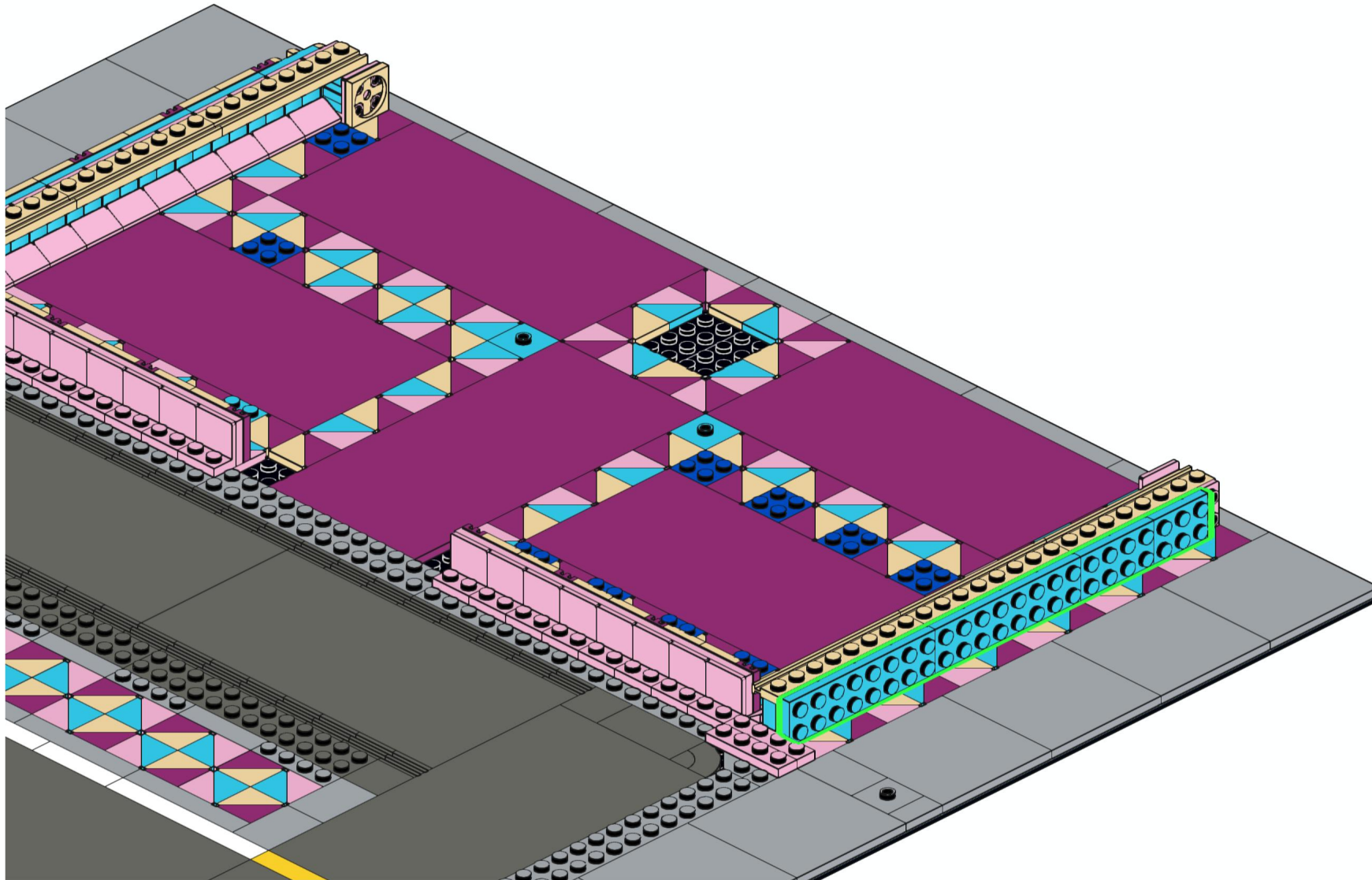
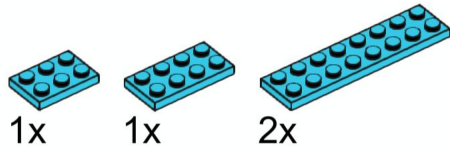

# 150



6x

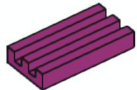

5x

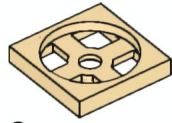

8x

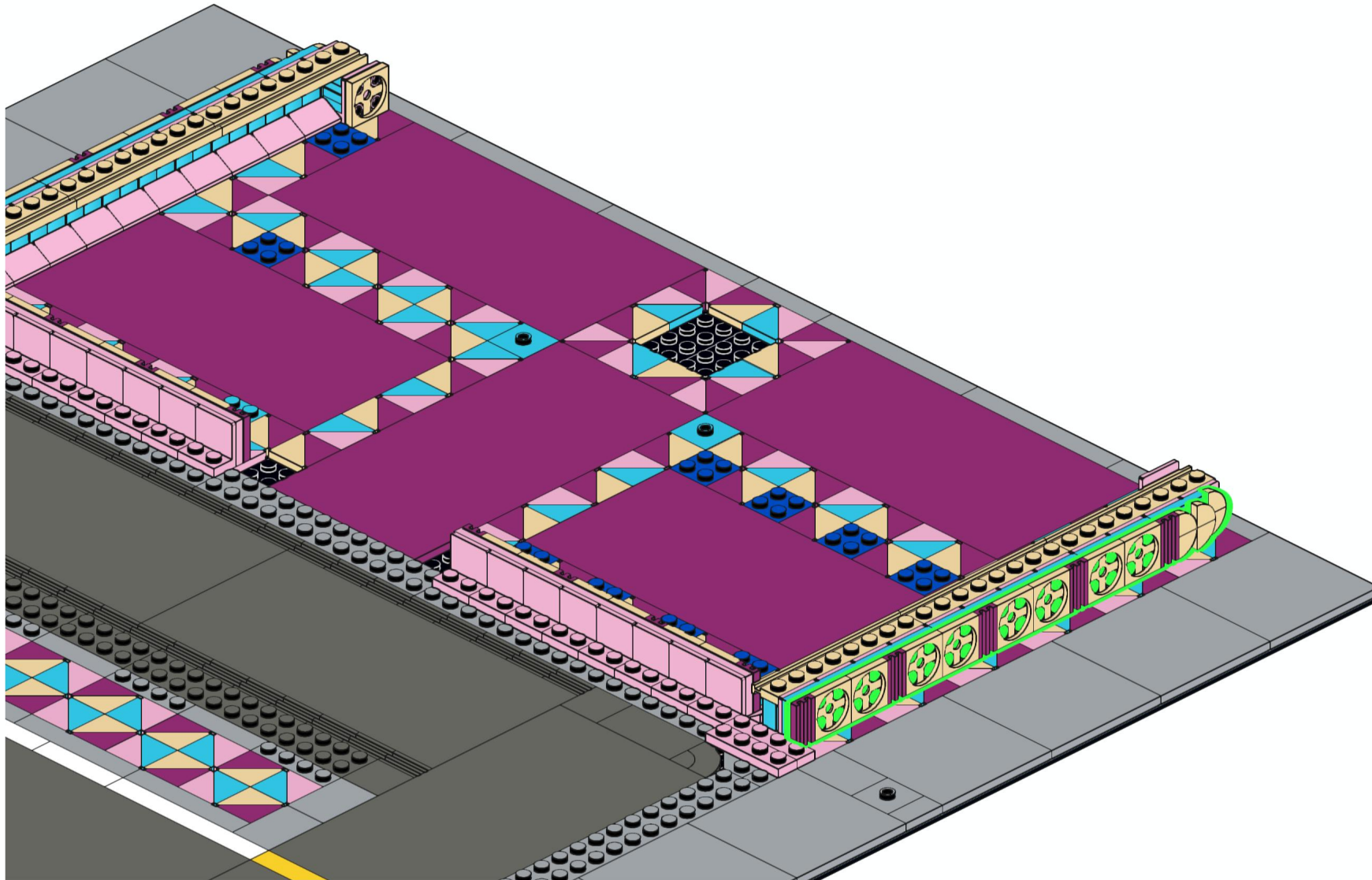

# 151

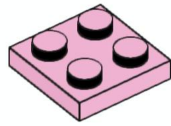

2x

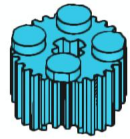

4x

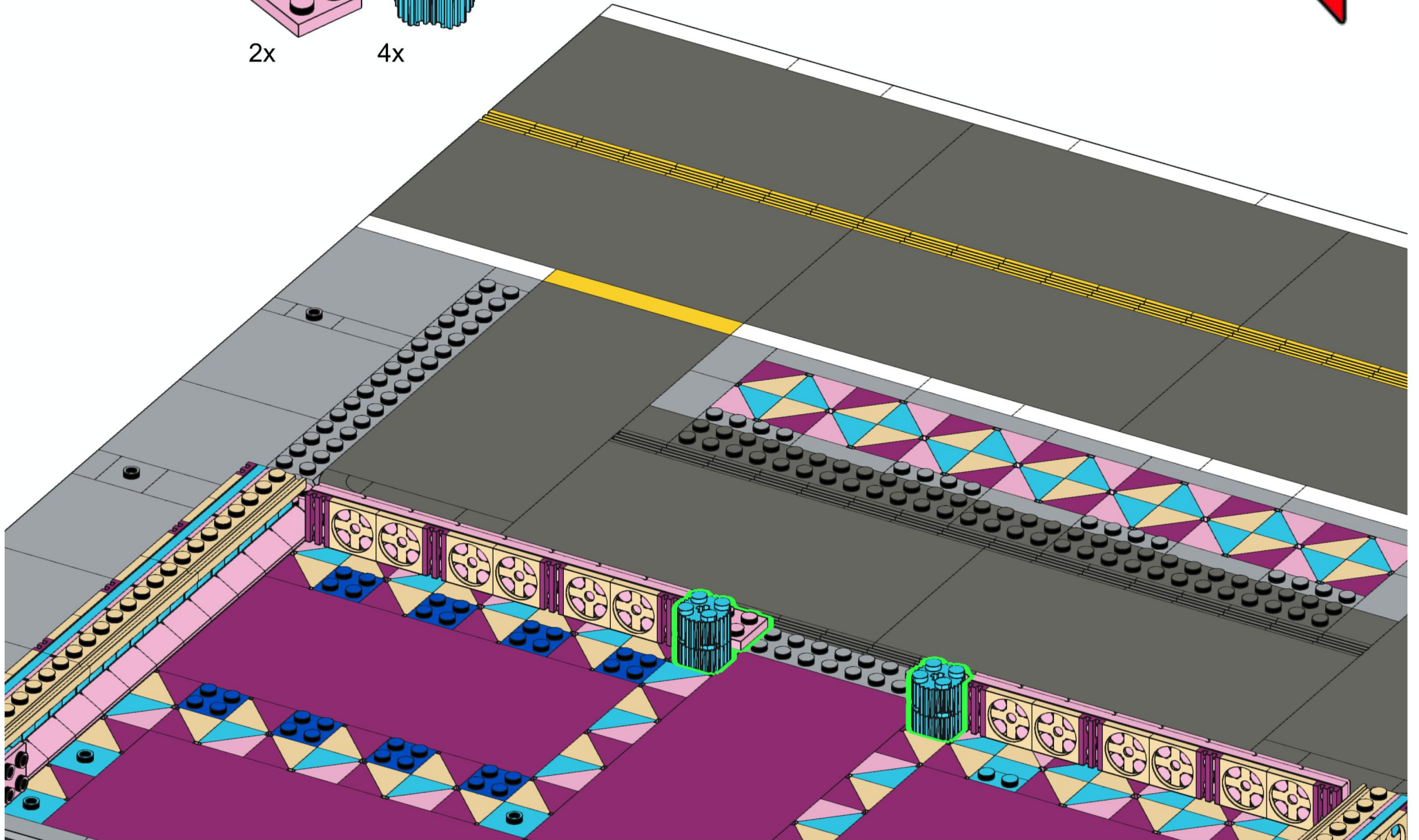



# 152



16x

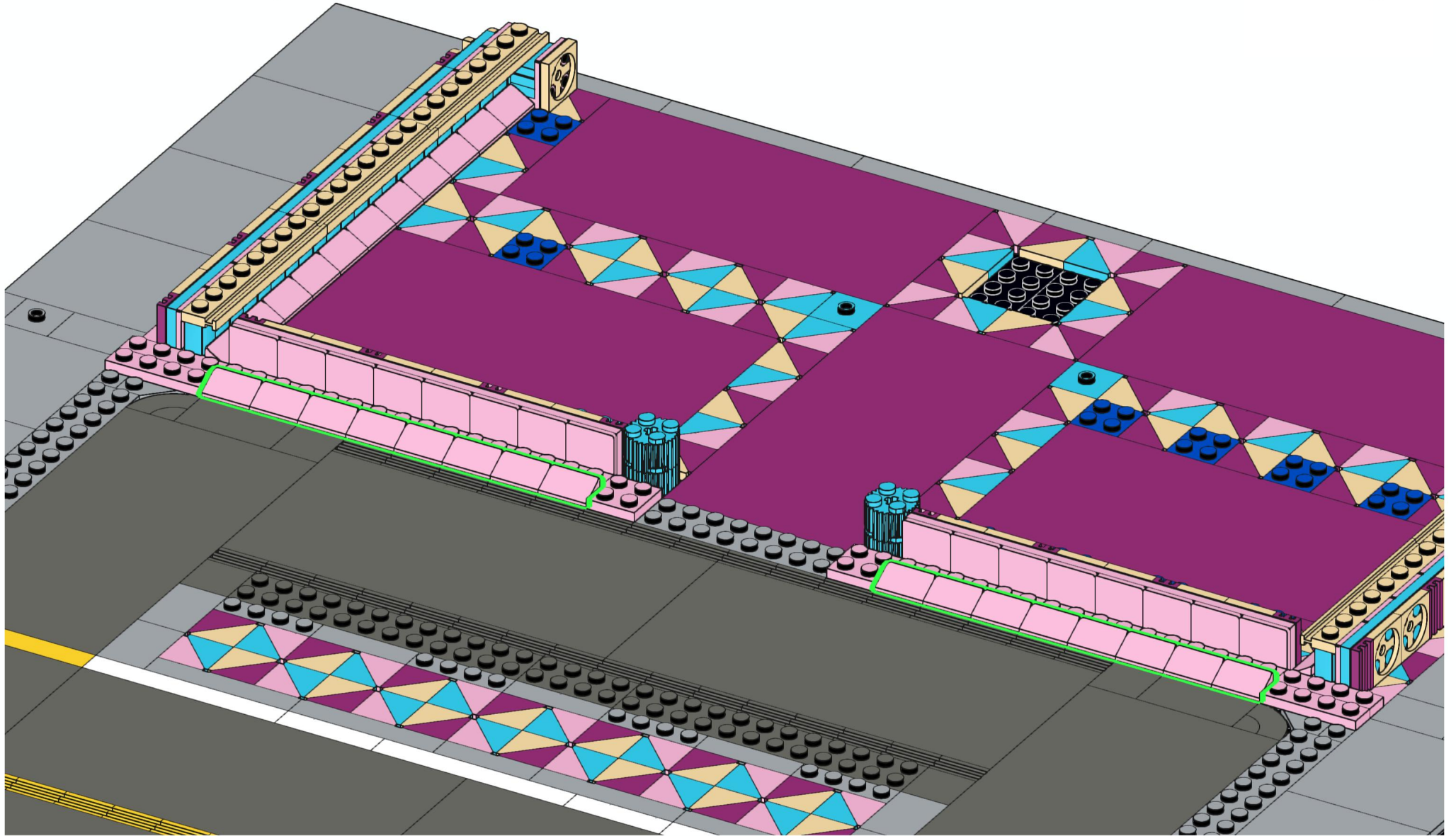

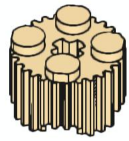

# 153

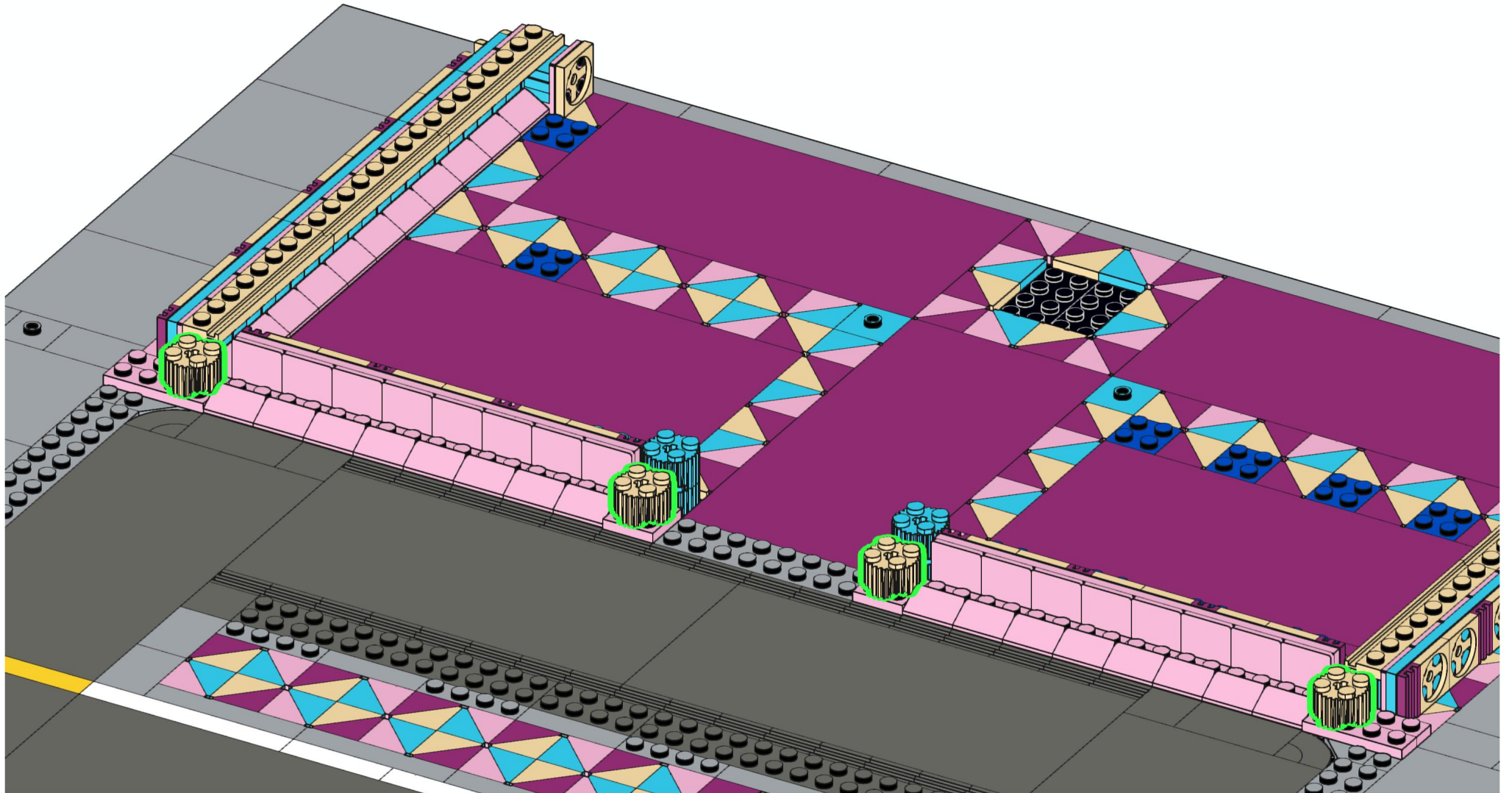

4x

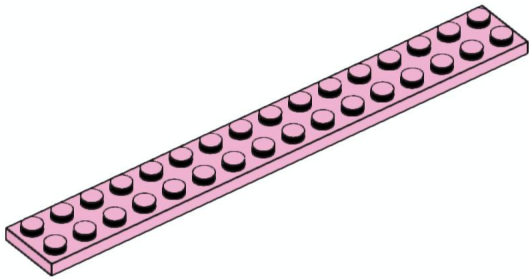

# 154

- 1x  1x  1x  1x 

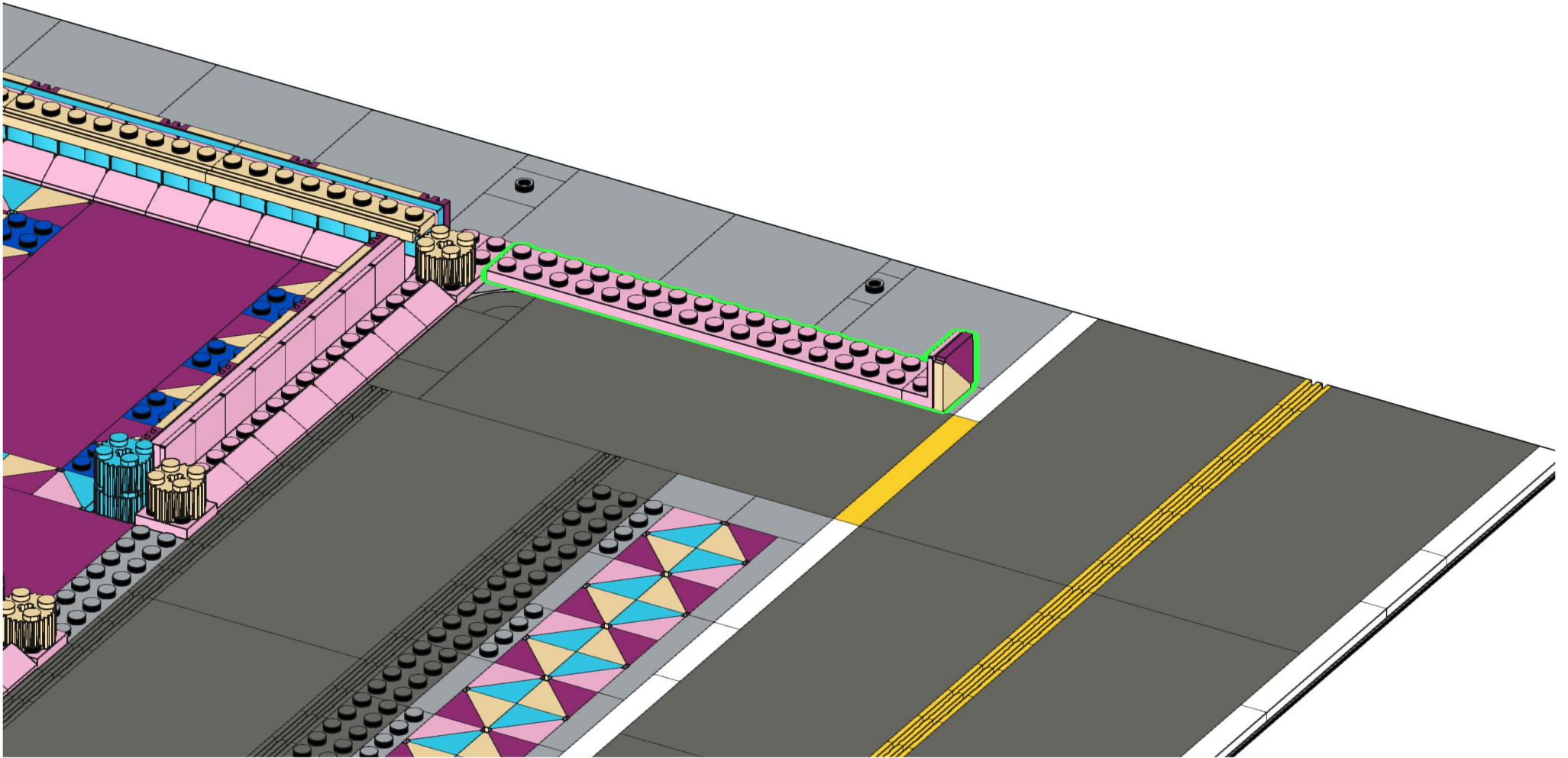

# 155



1x



1x

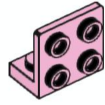

1x

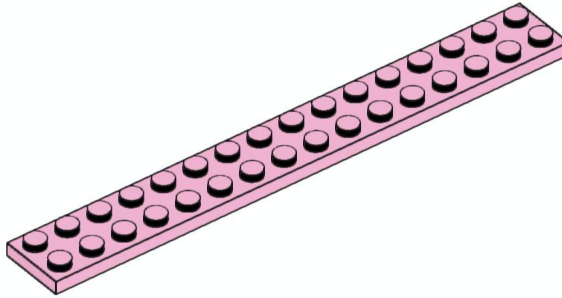

1x

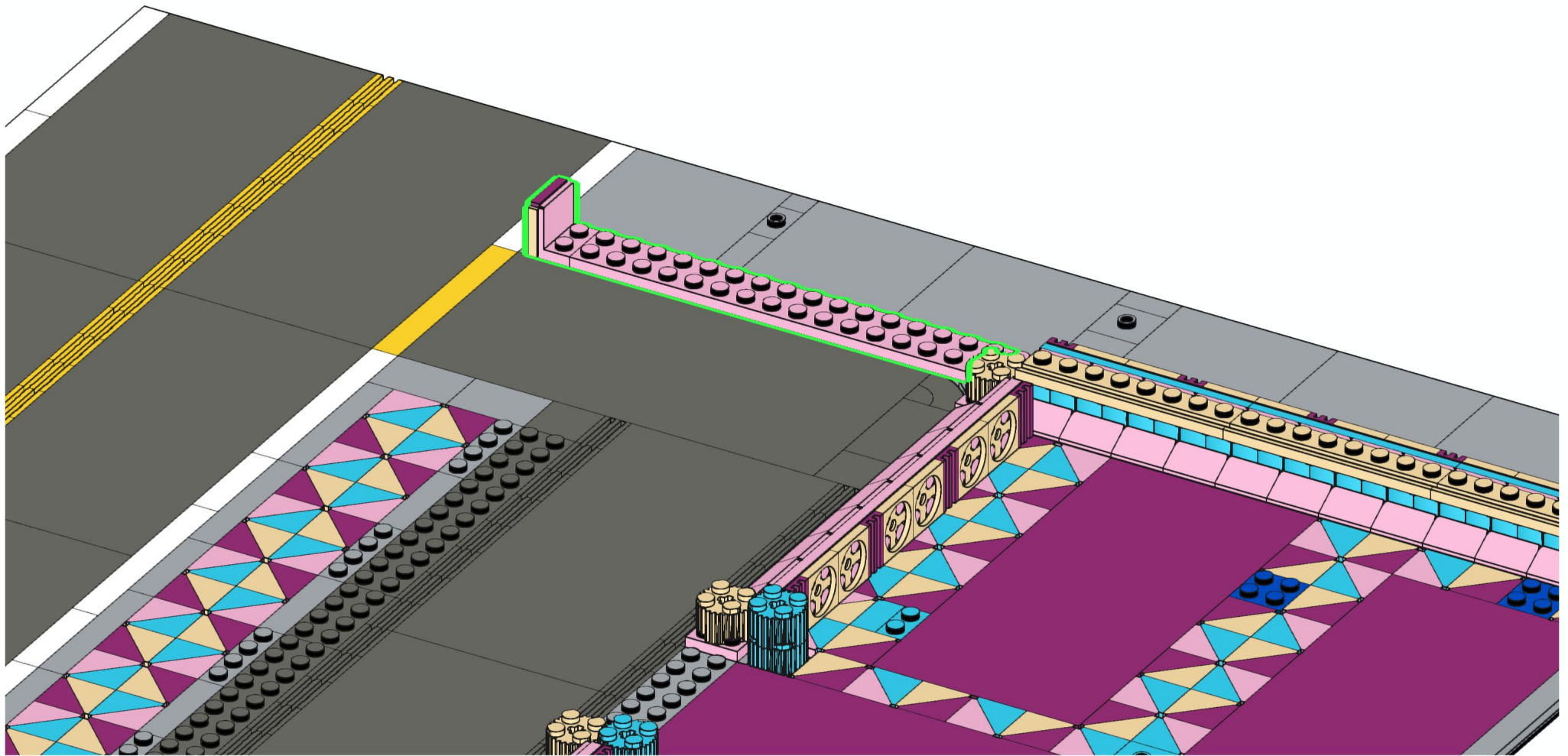

# 156

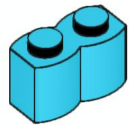

19x

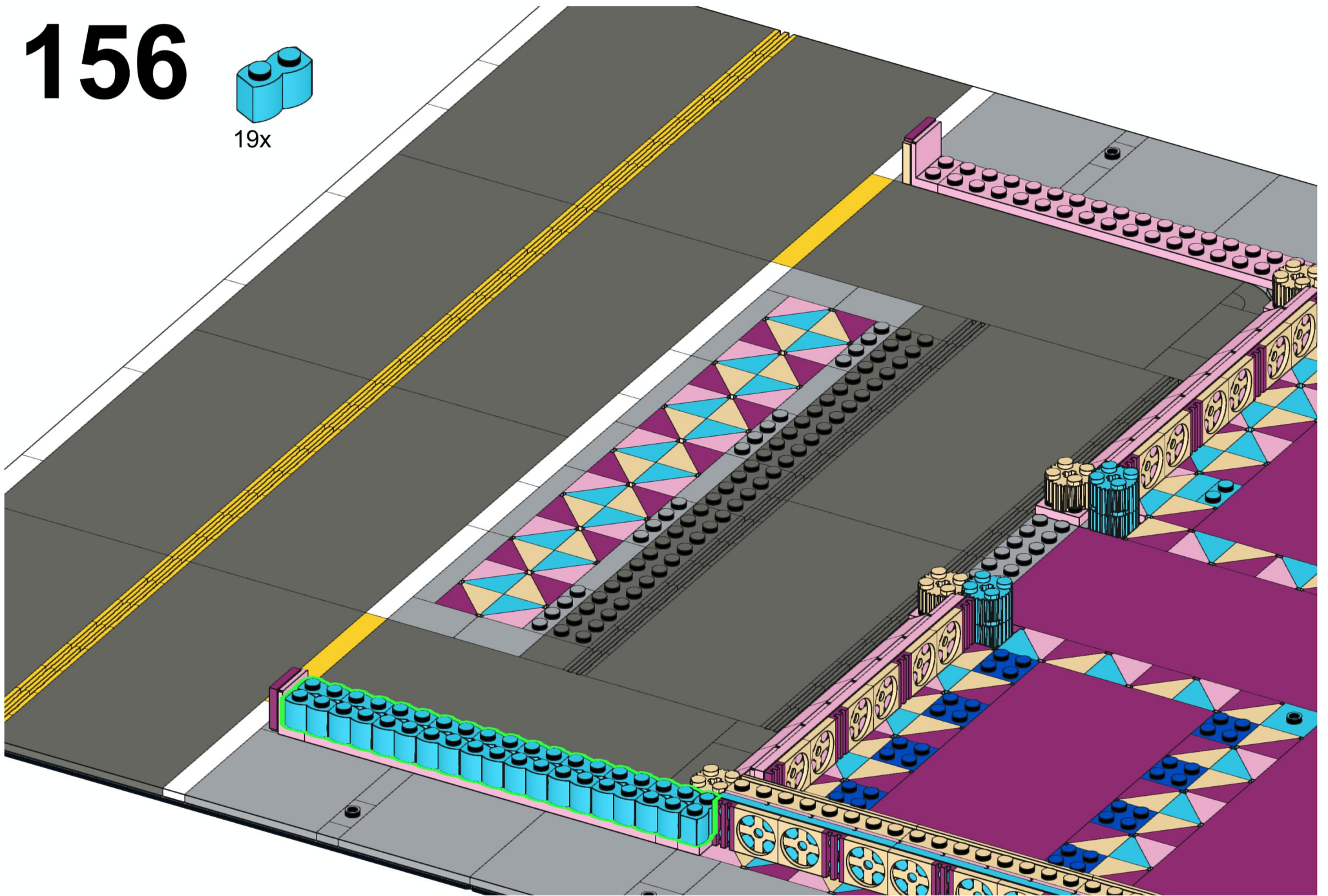

# 157

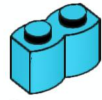

8x

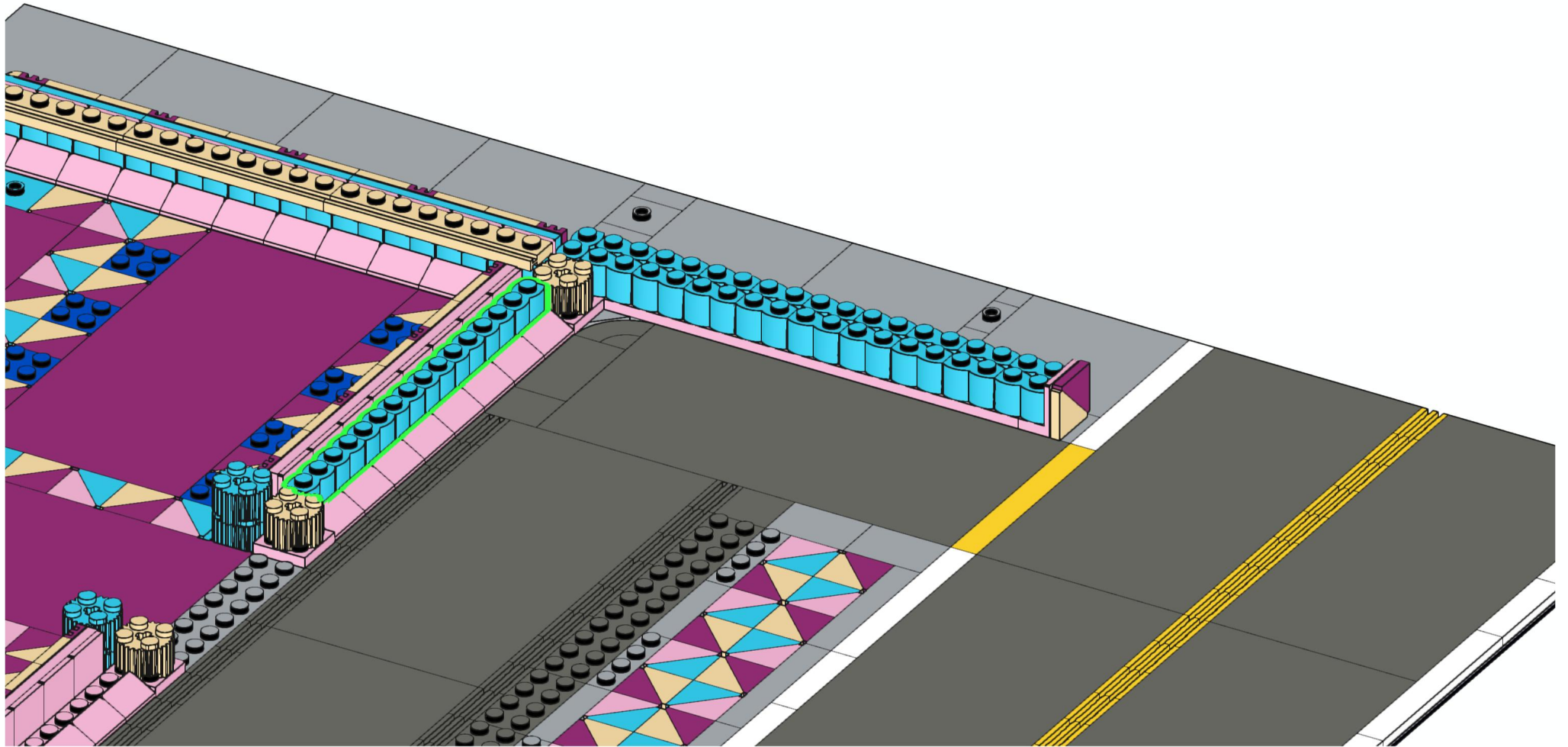

# 158

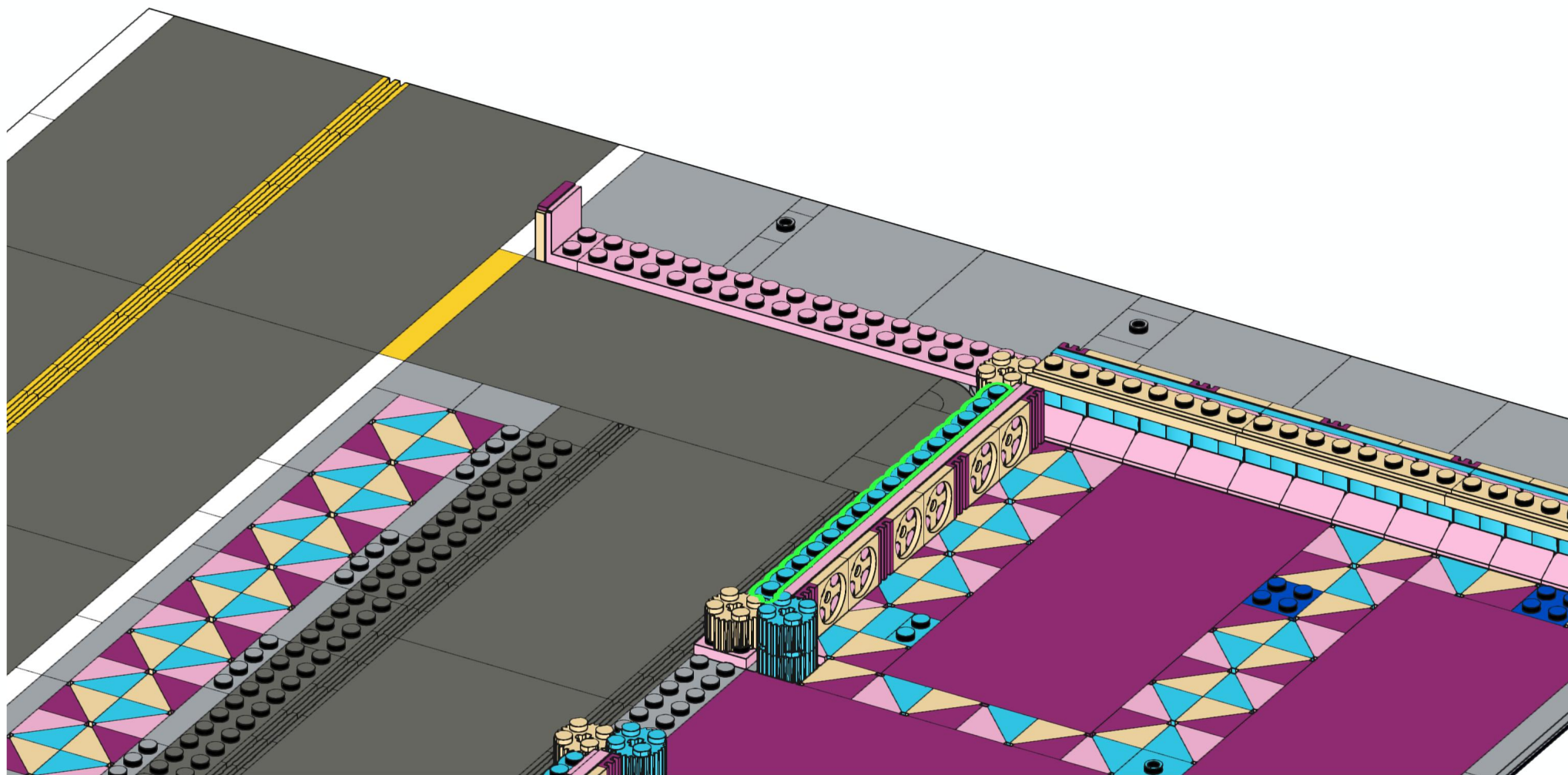

# 159

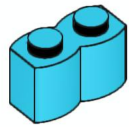

19x

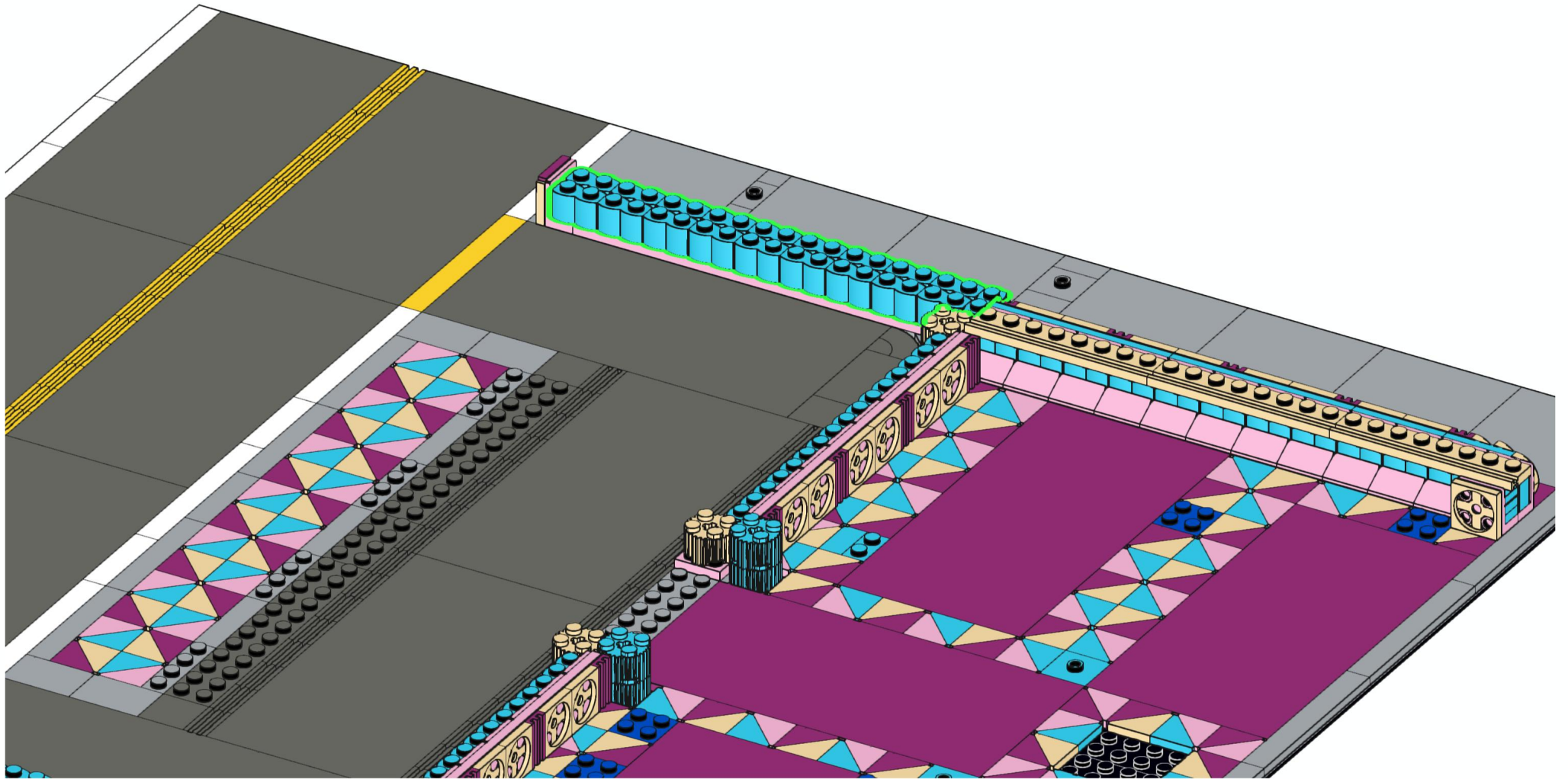



# 160

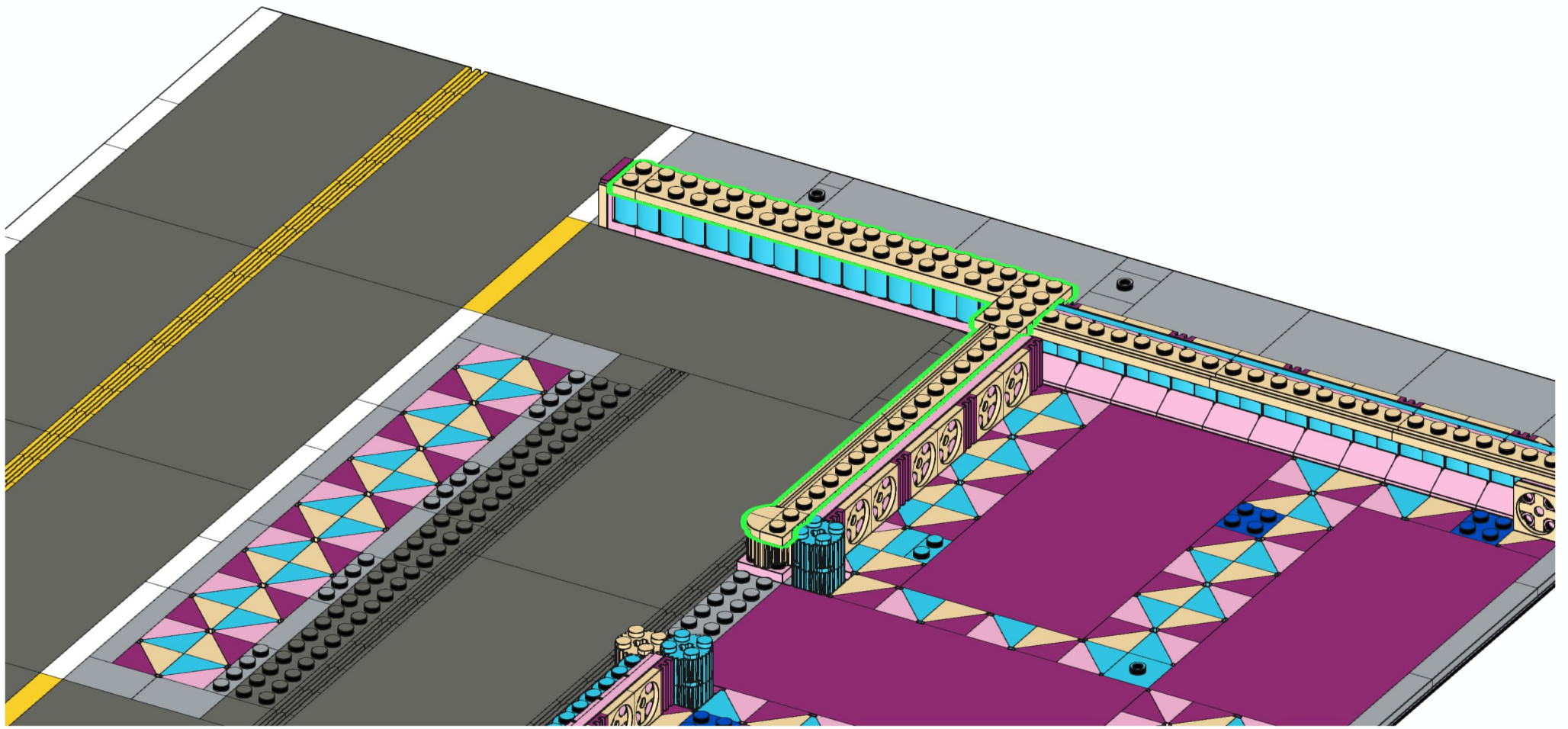
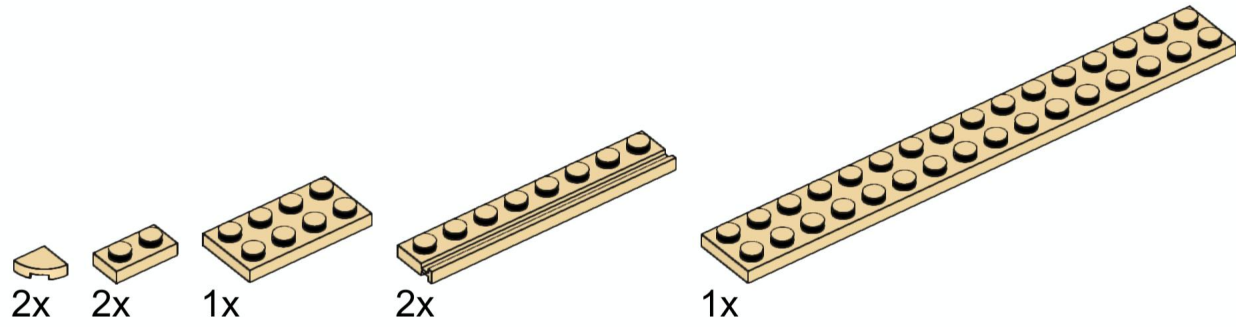

# 161

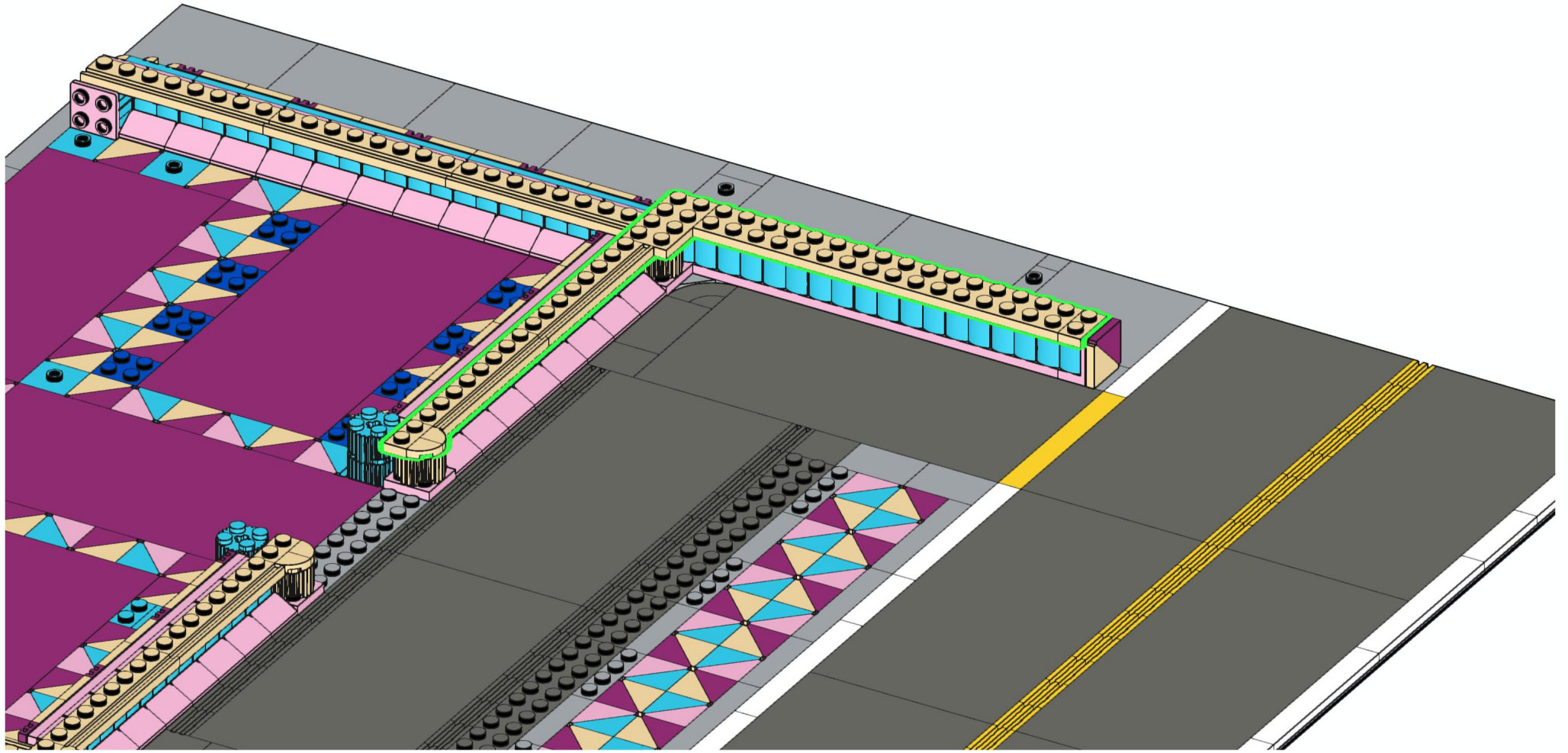
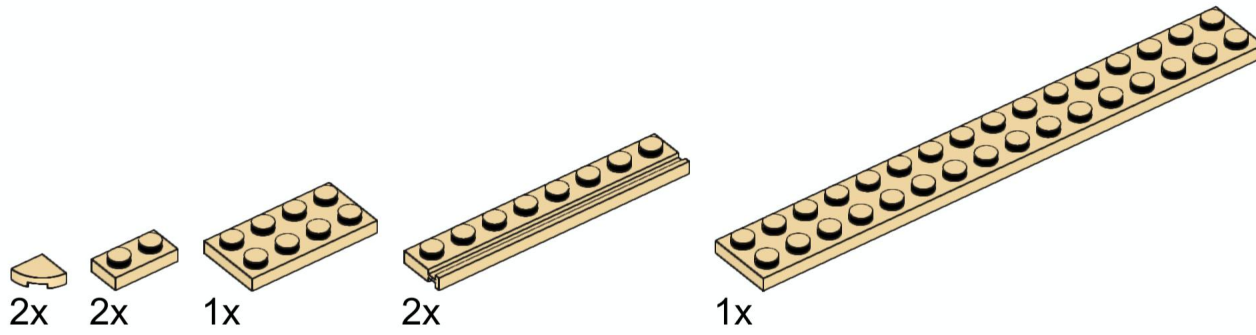

# 162

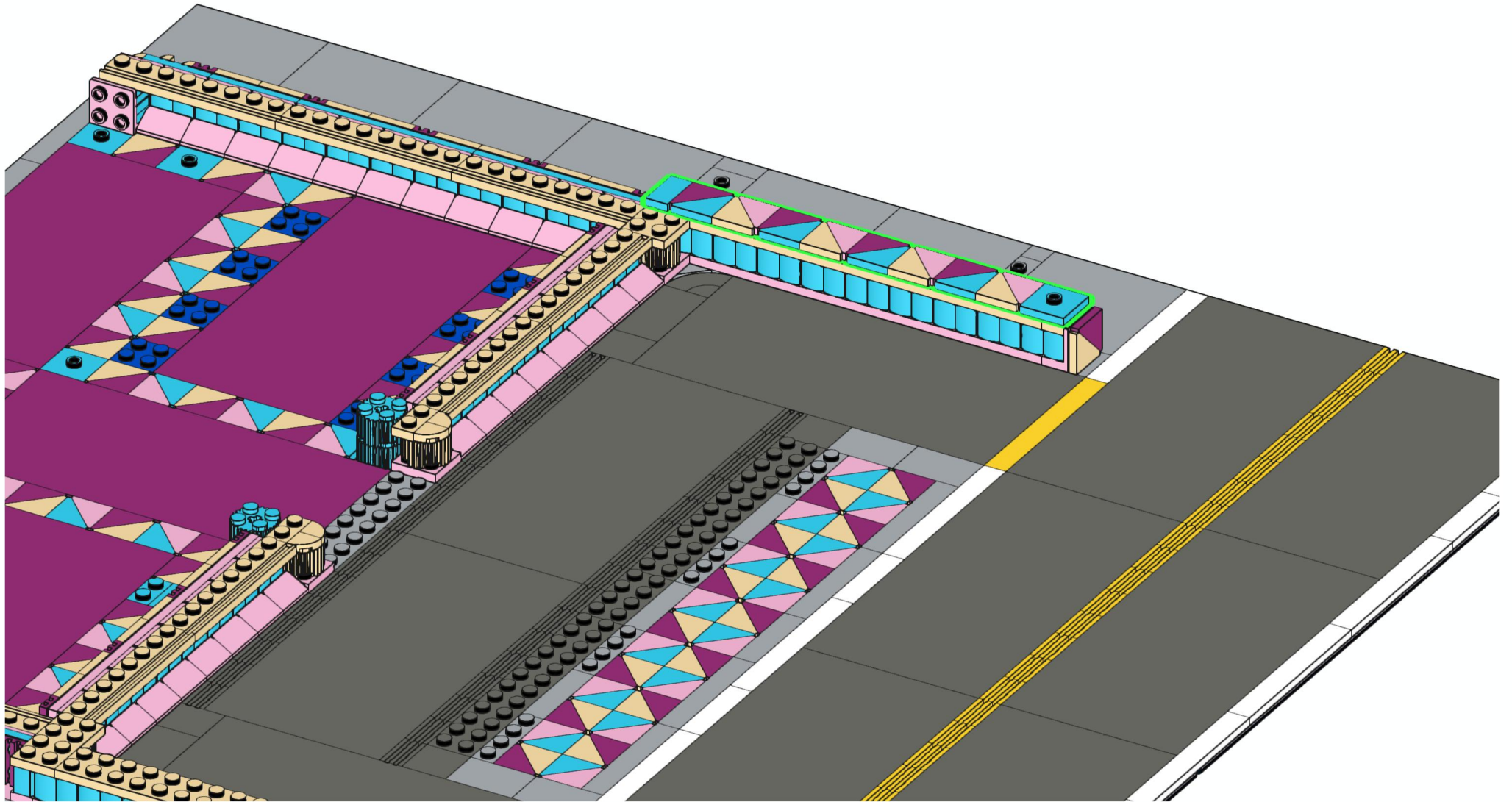
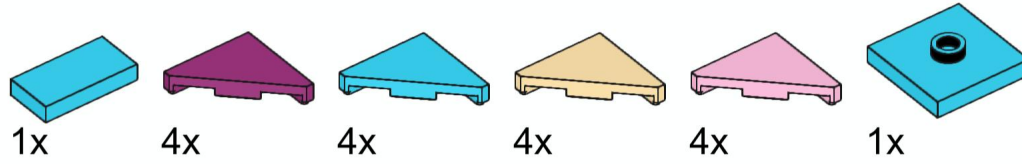

# 163

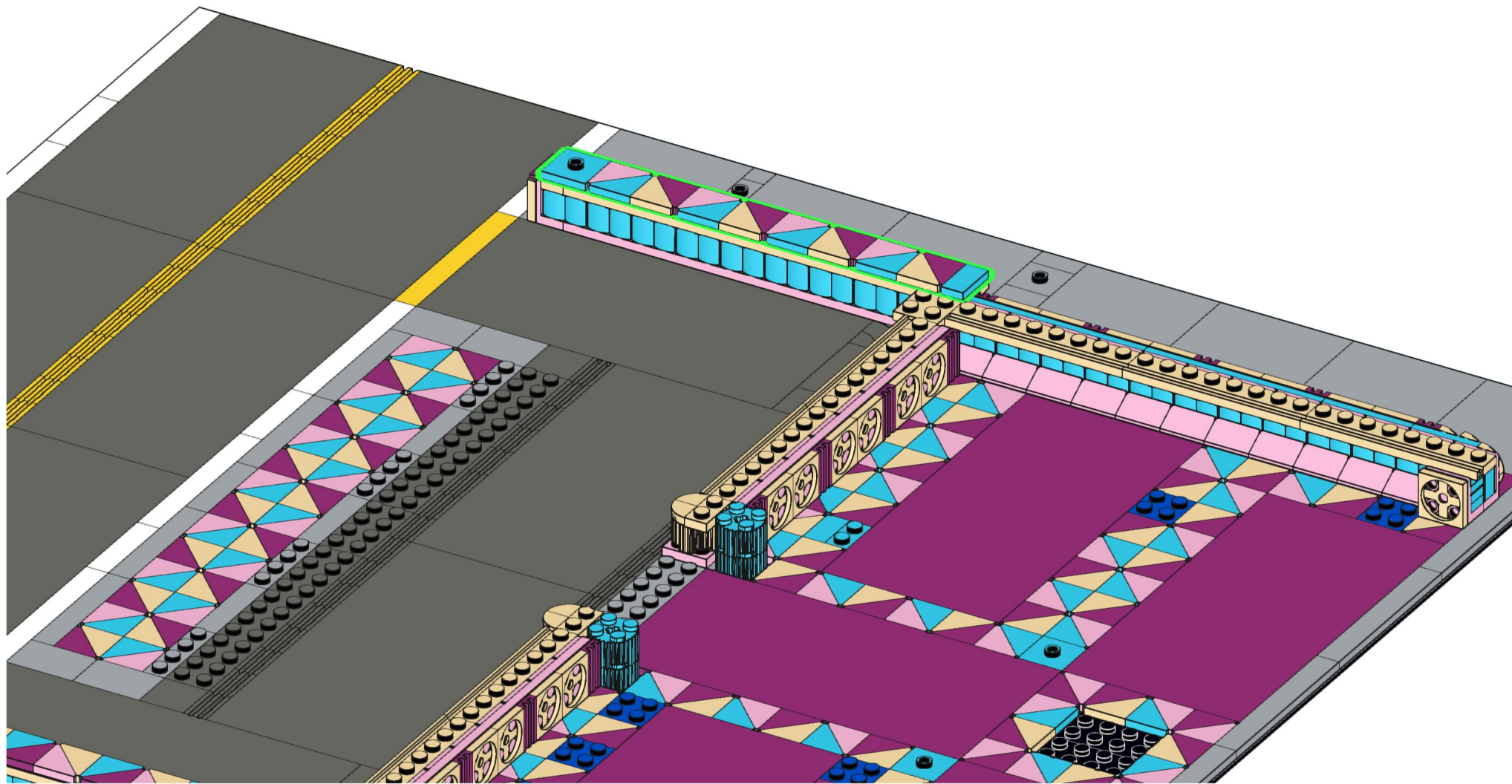
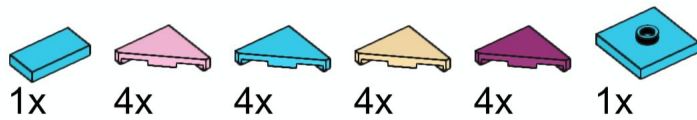

# 164

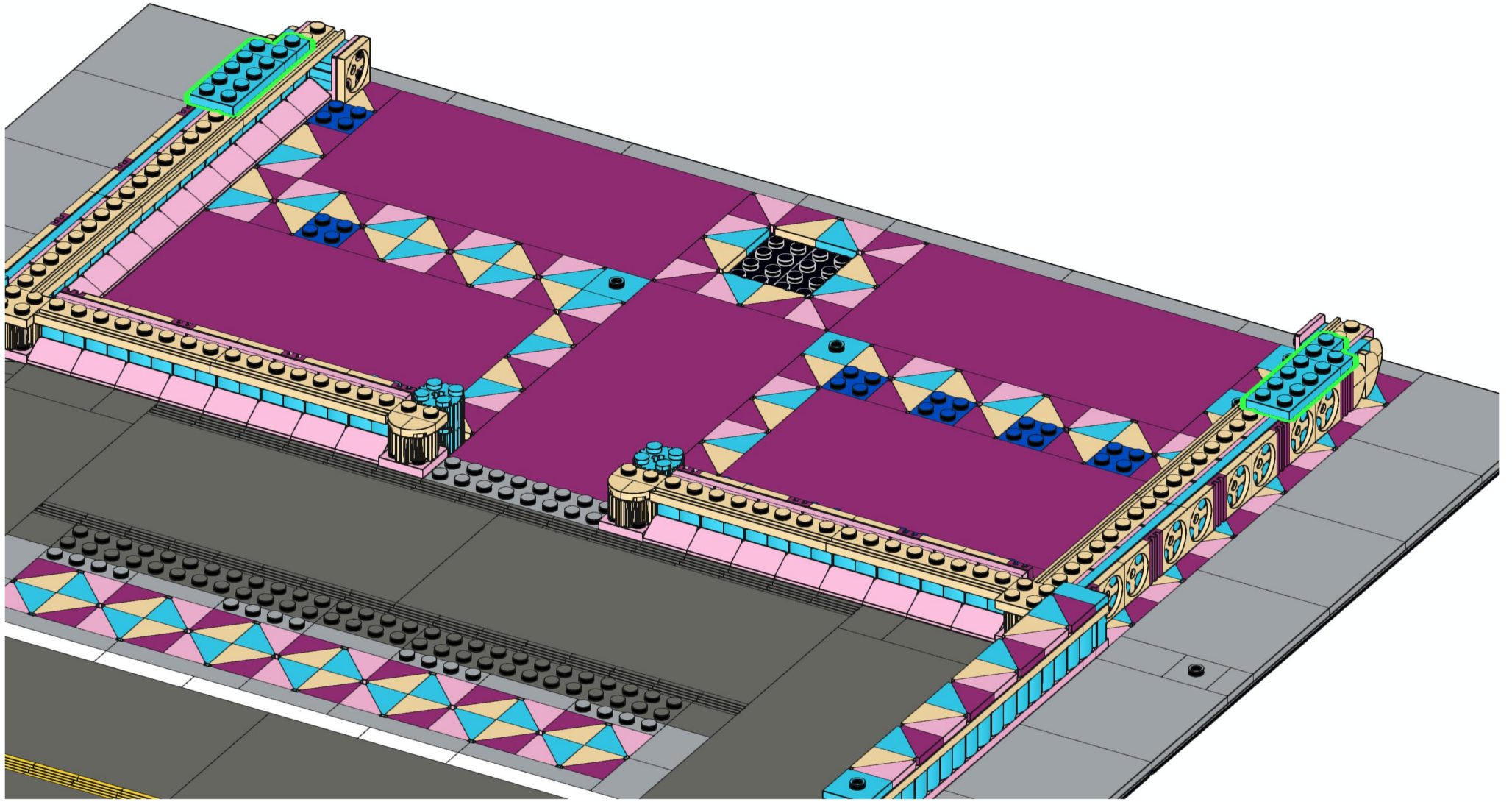
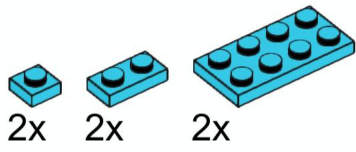

# 165

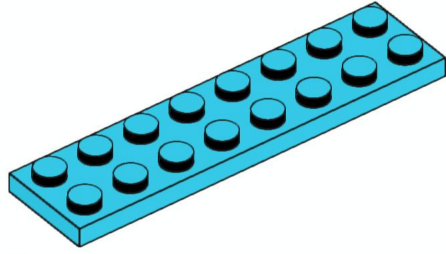

8x

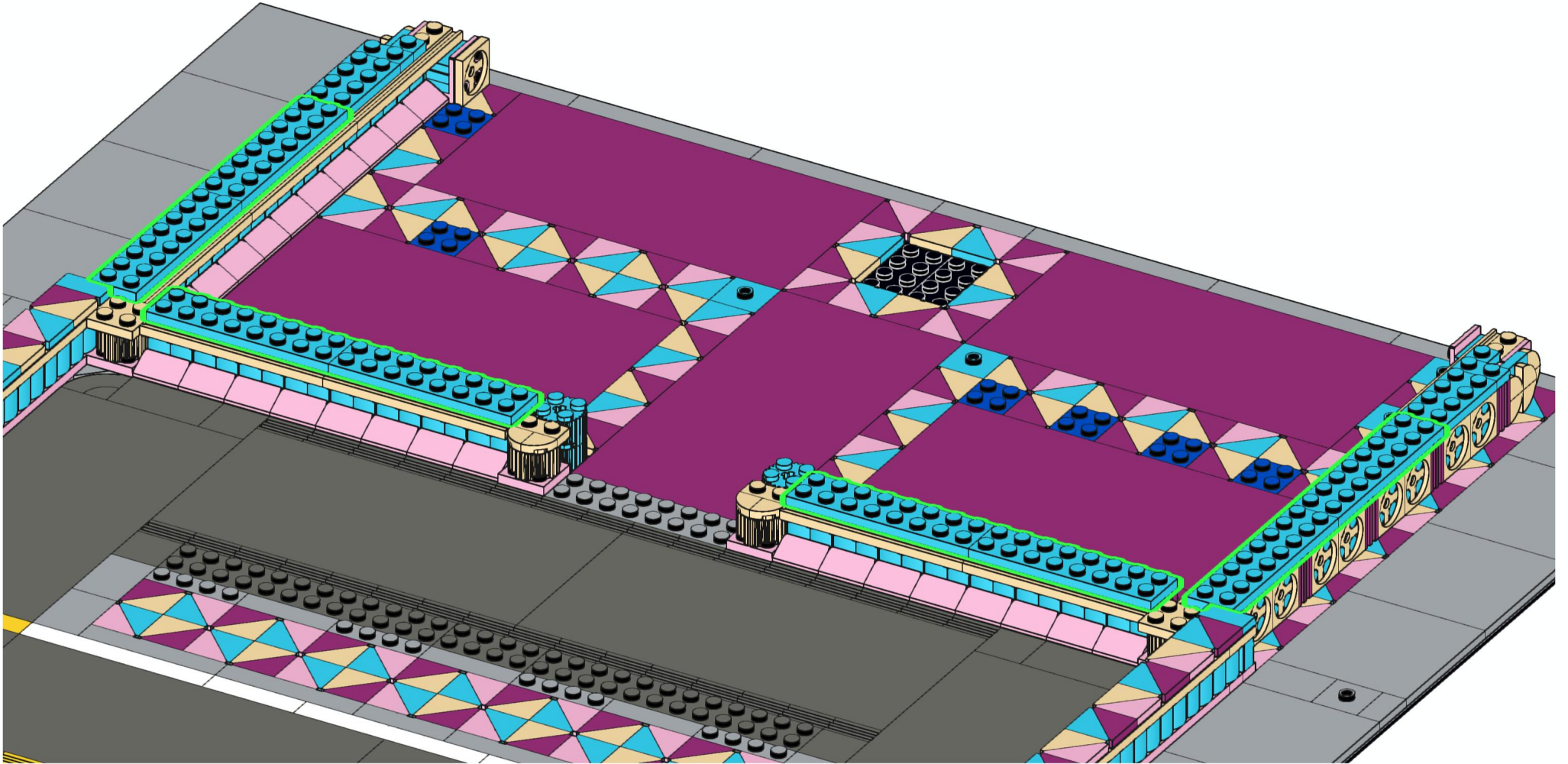

# 166

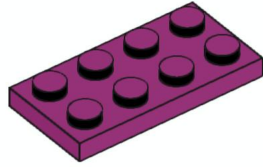

14x

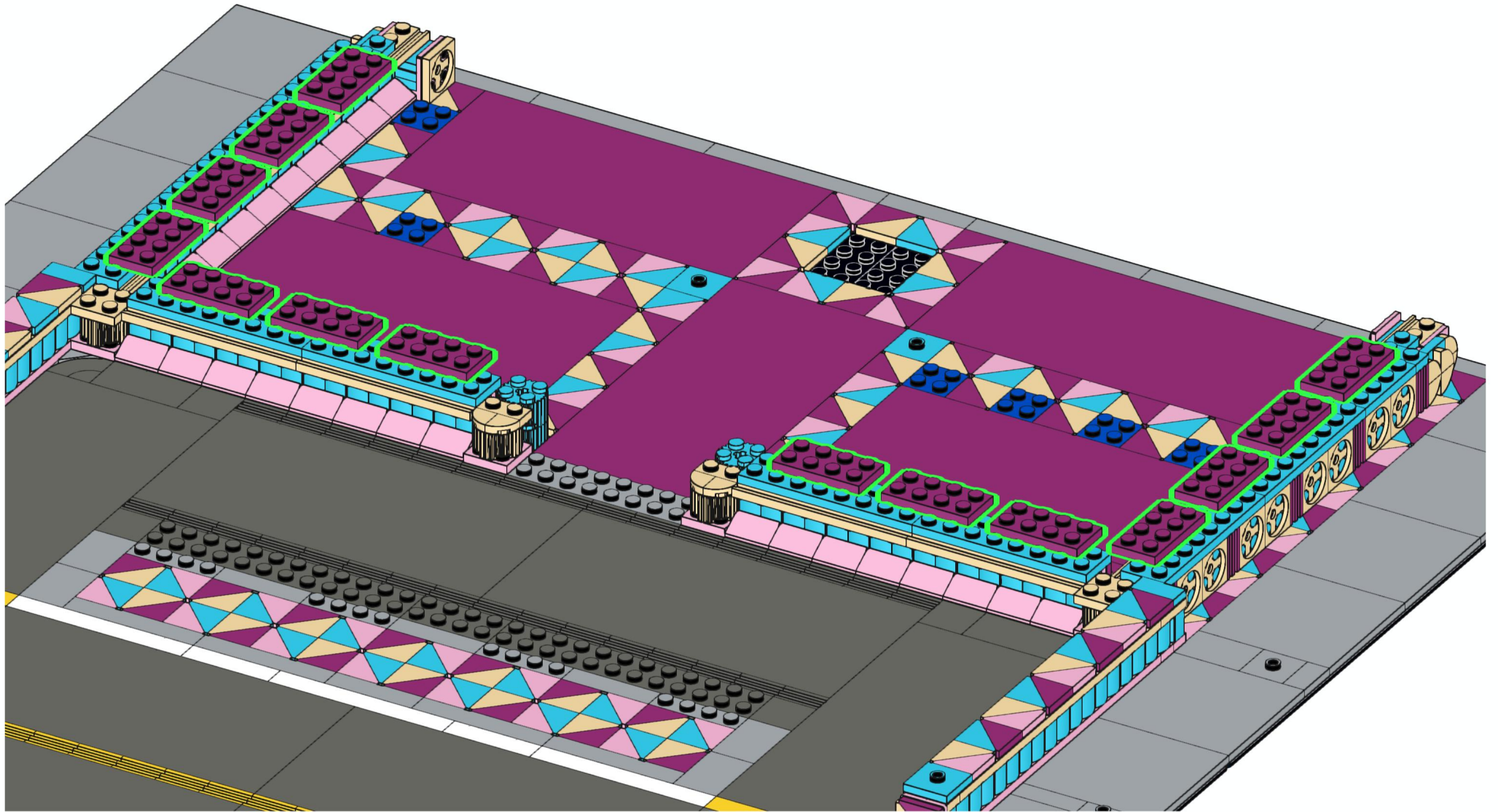

# 167

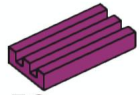

56x

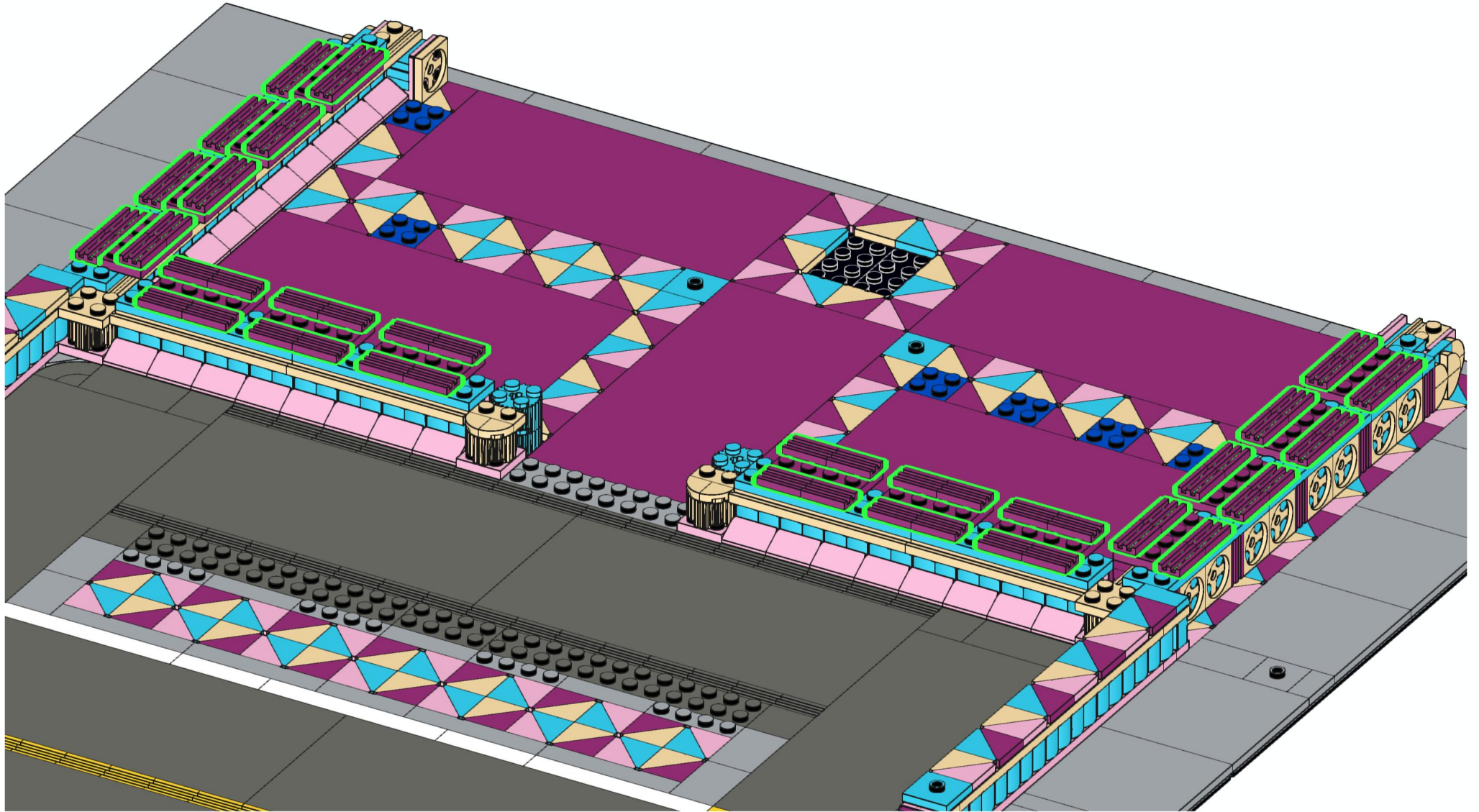



# 168

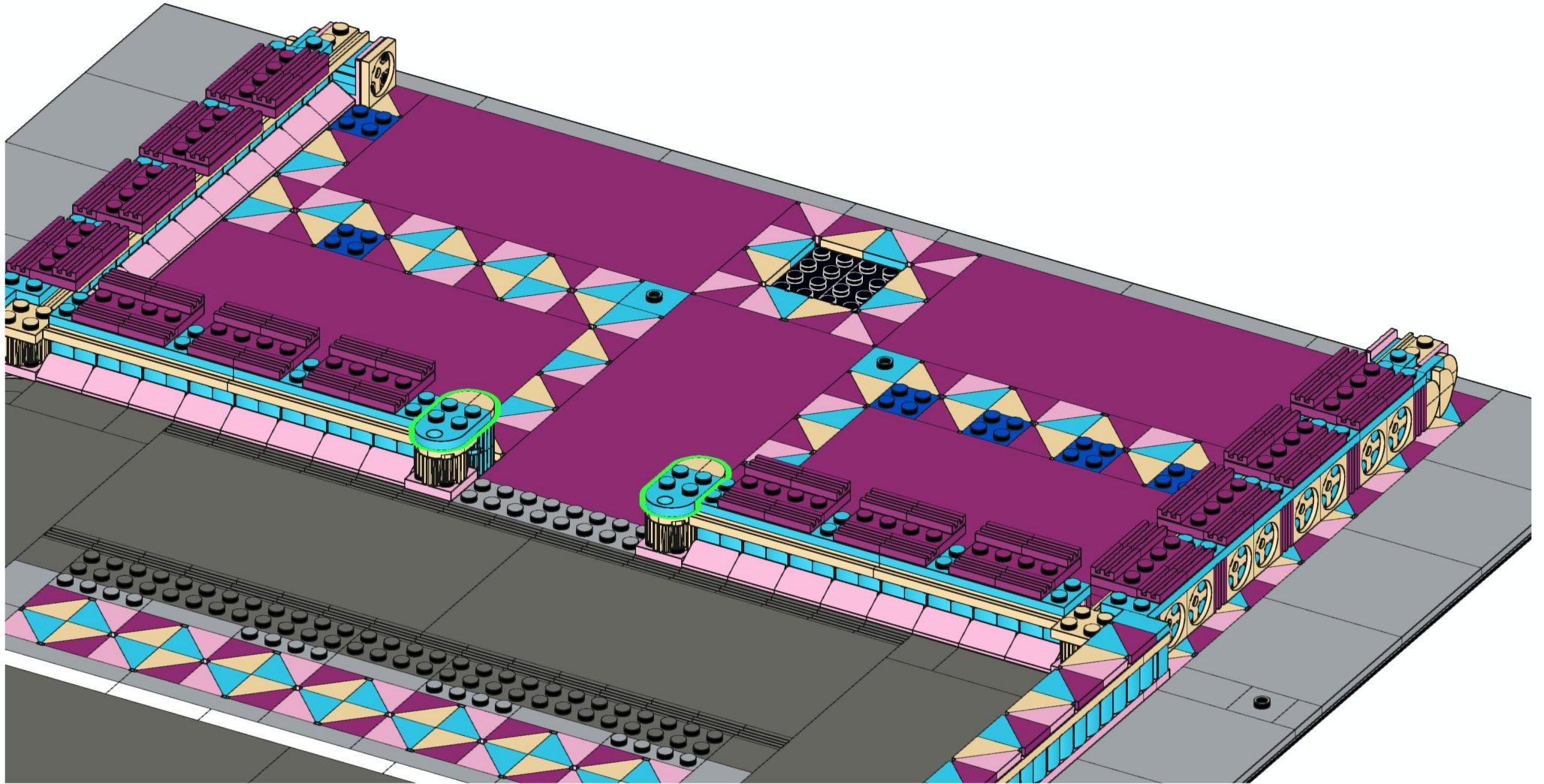
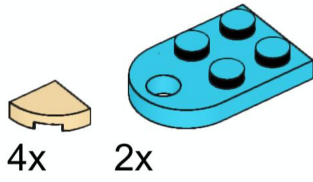

# 169

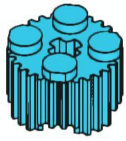

8x

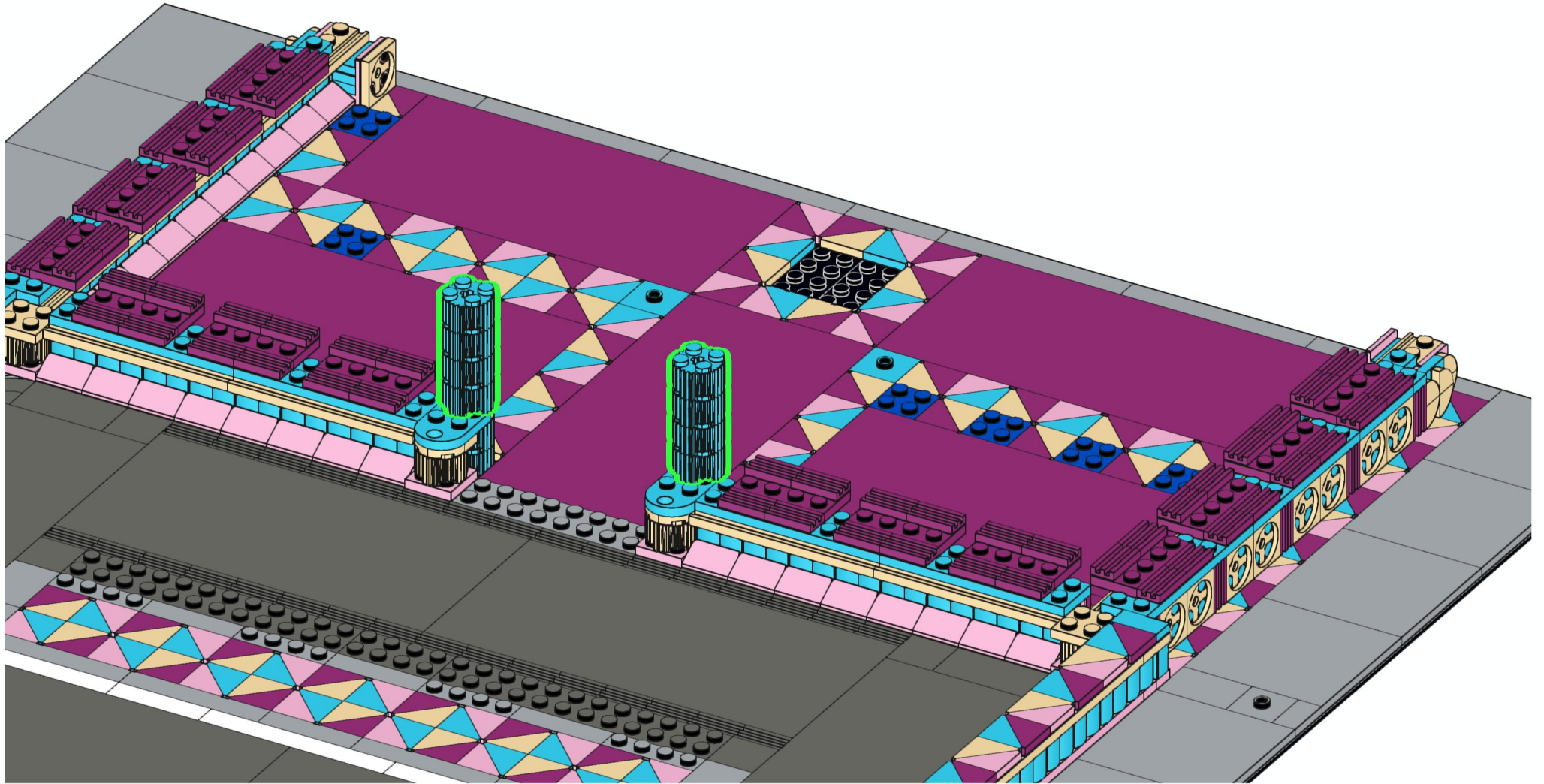

# 170

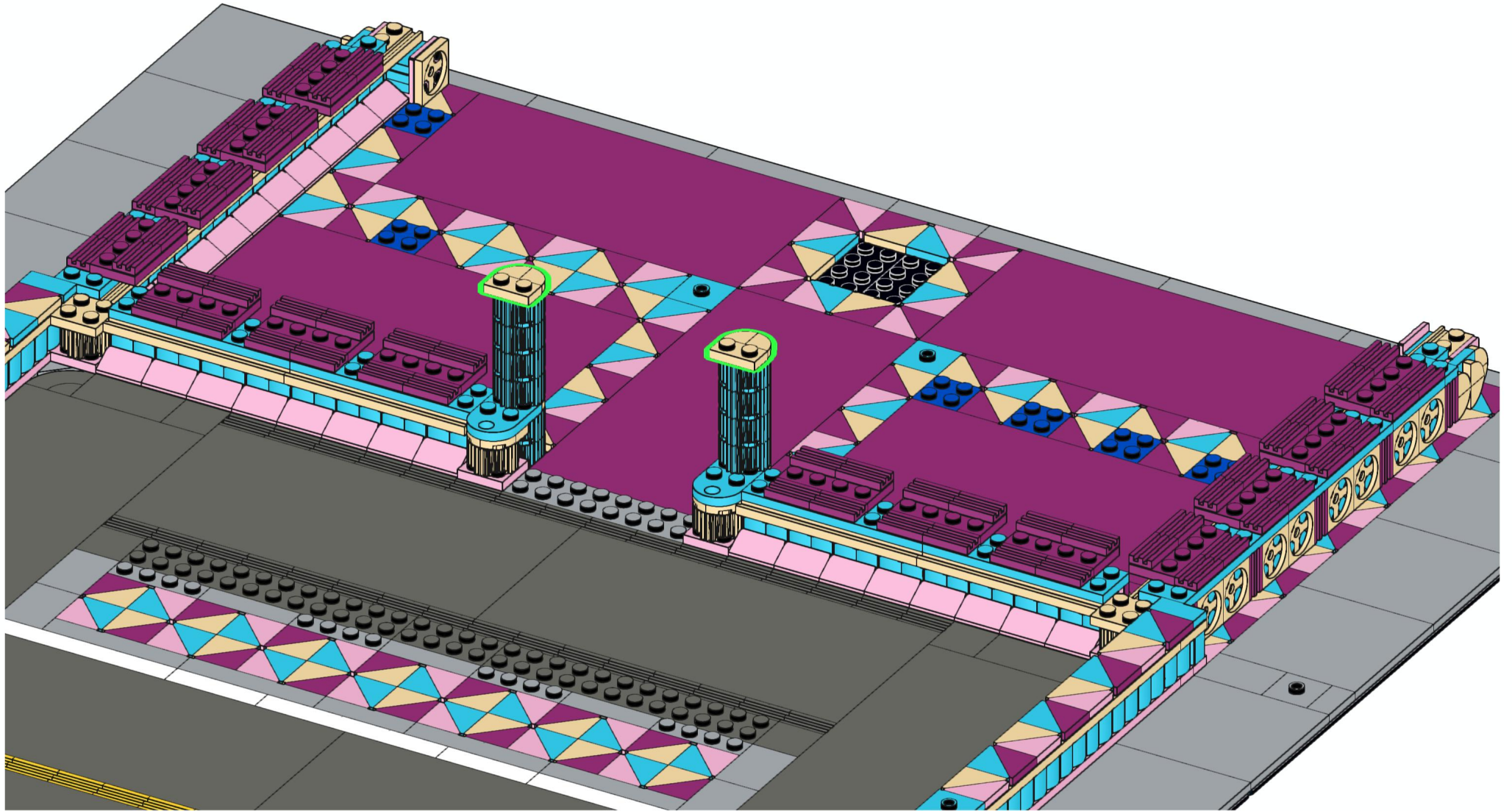
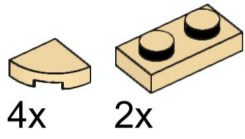

# 171

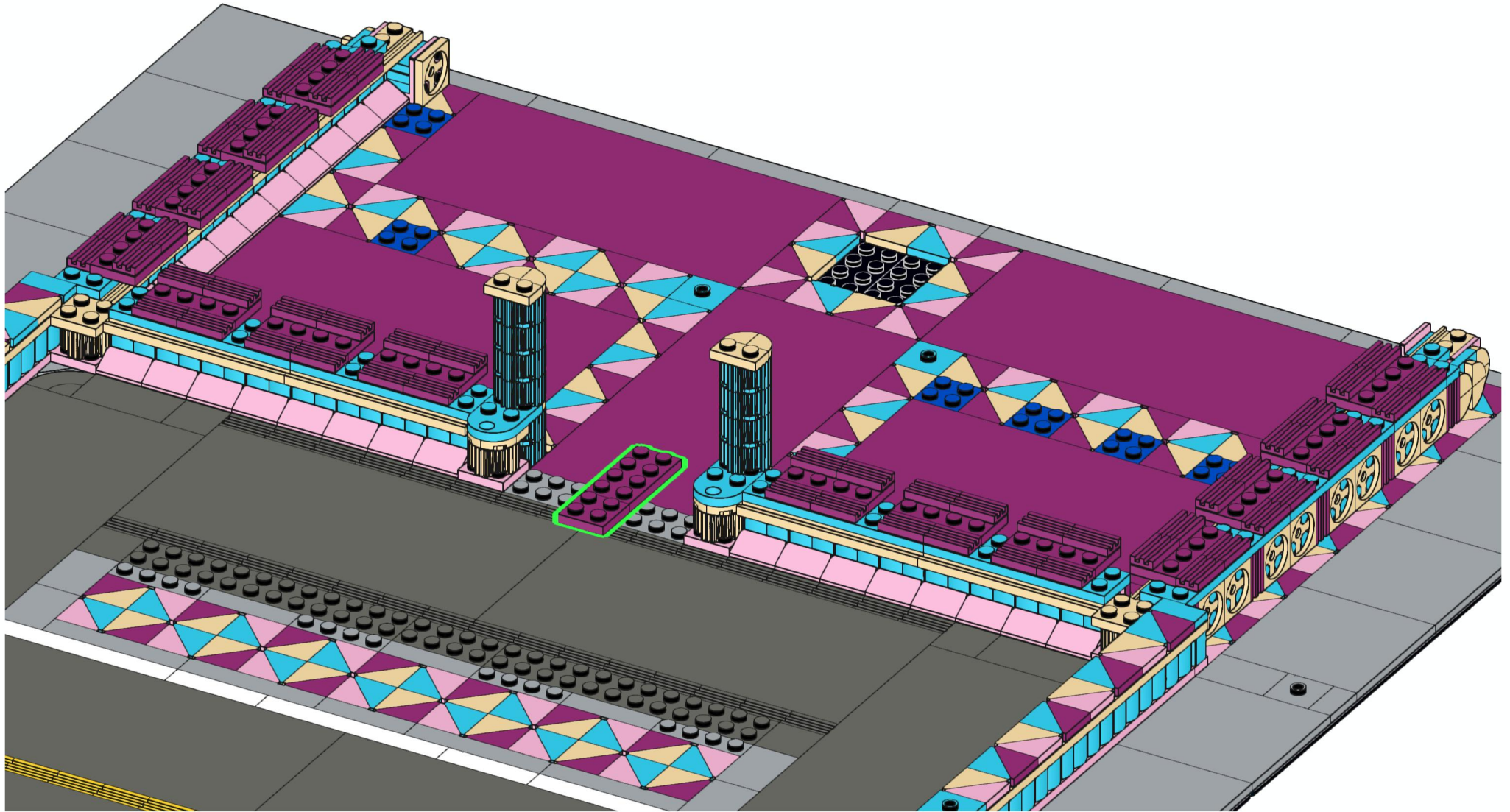
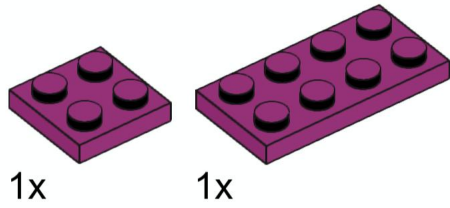

# 172

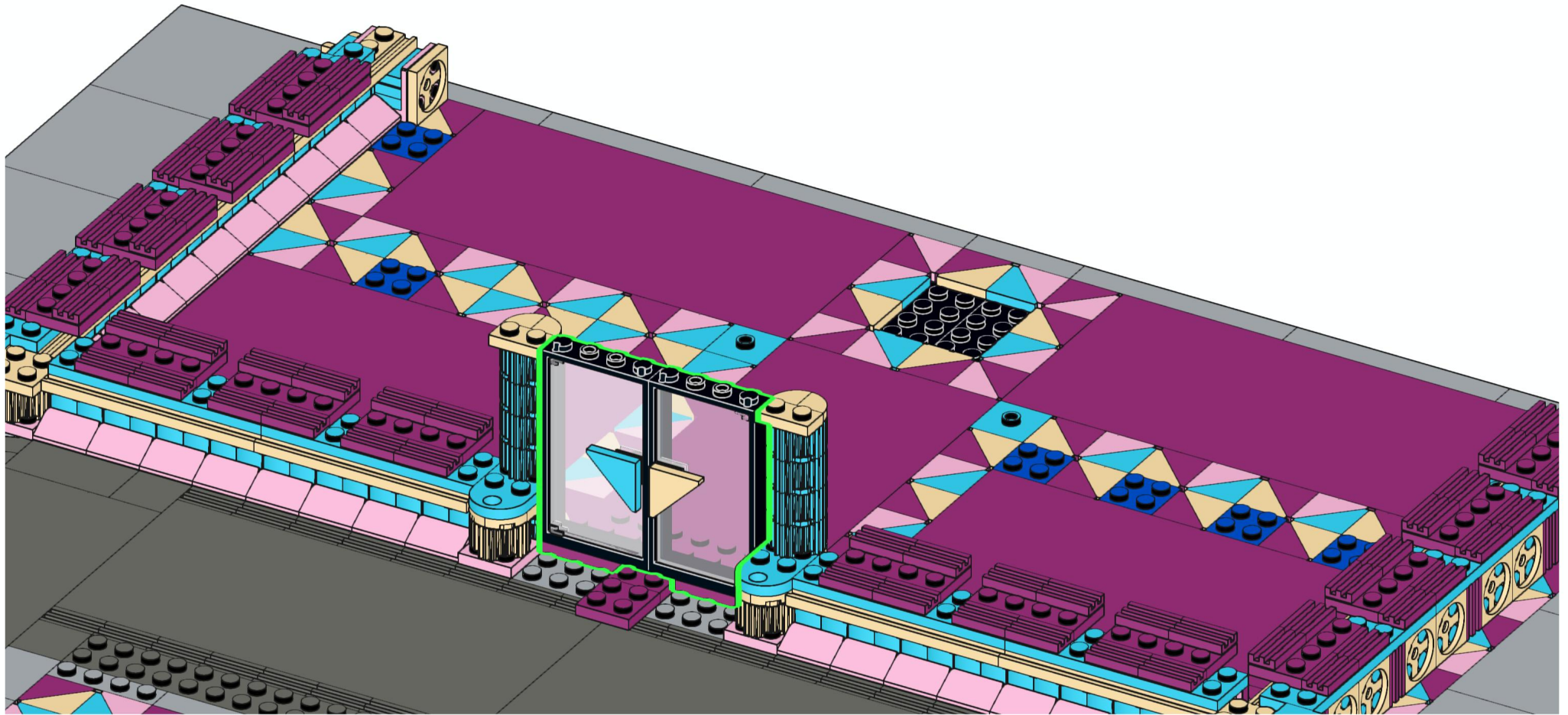
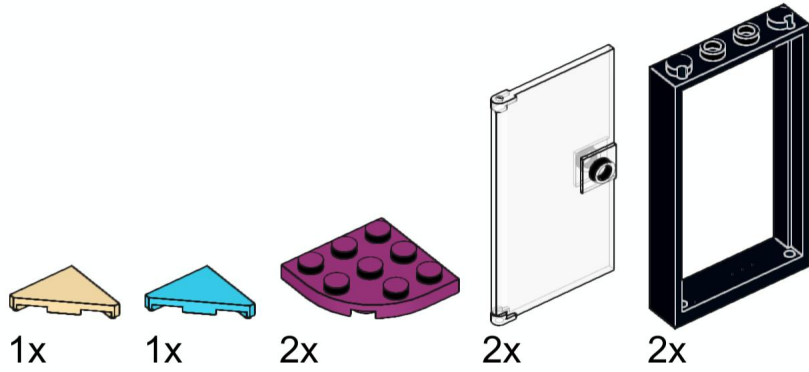

# 173

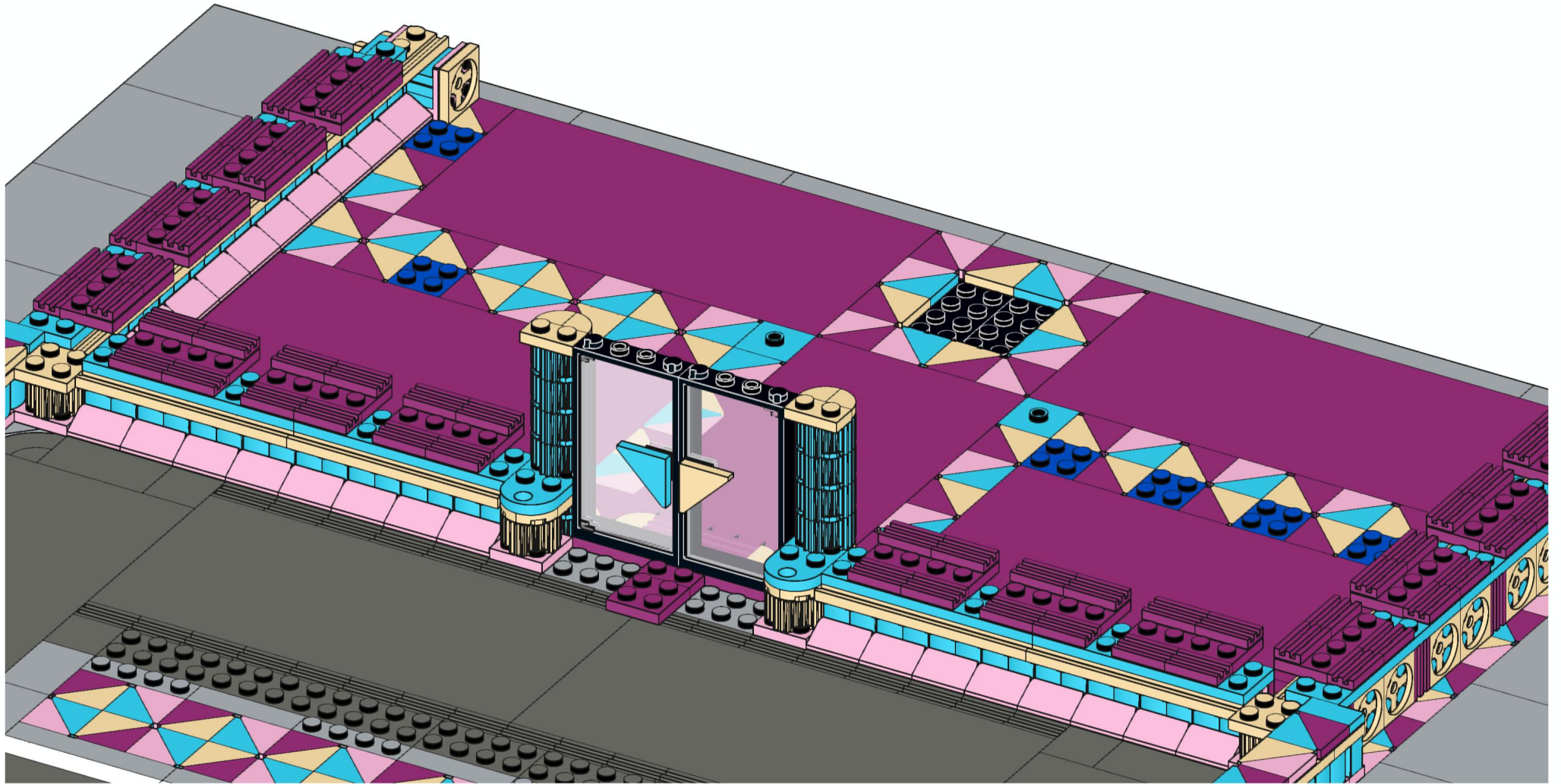
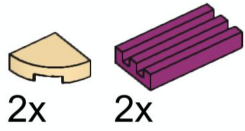

# 174

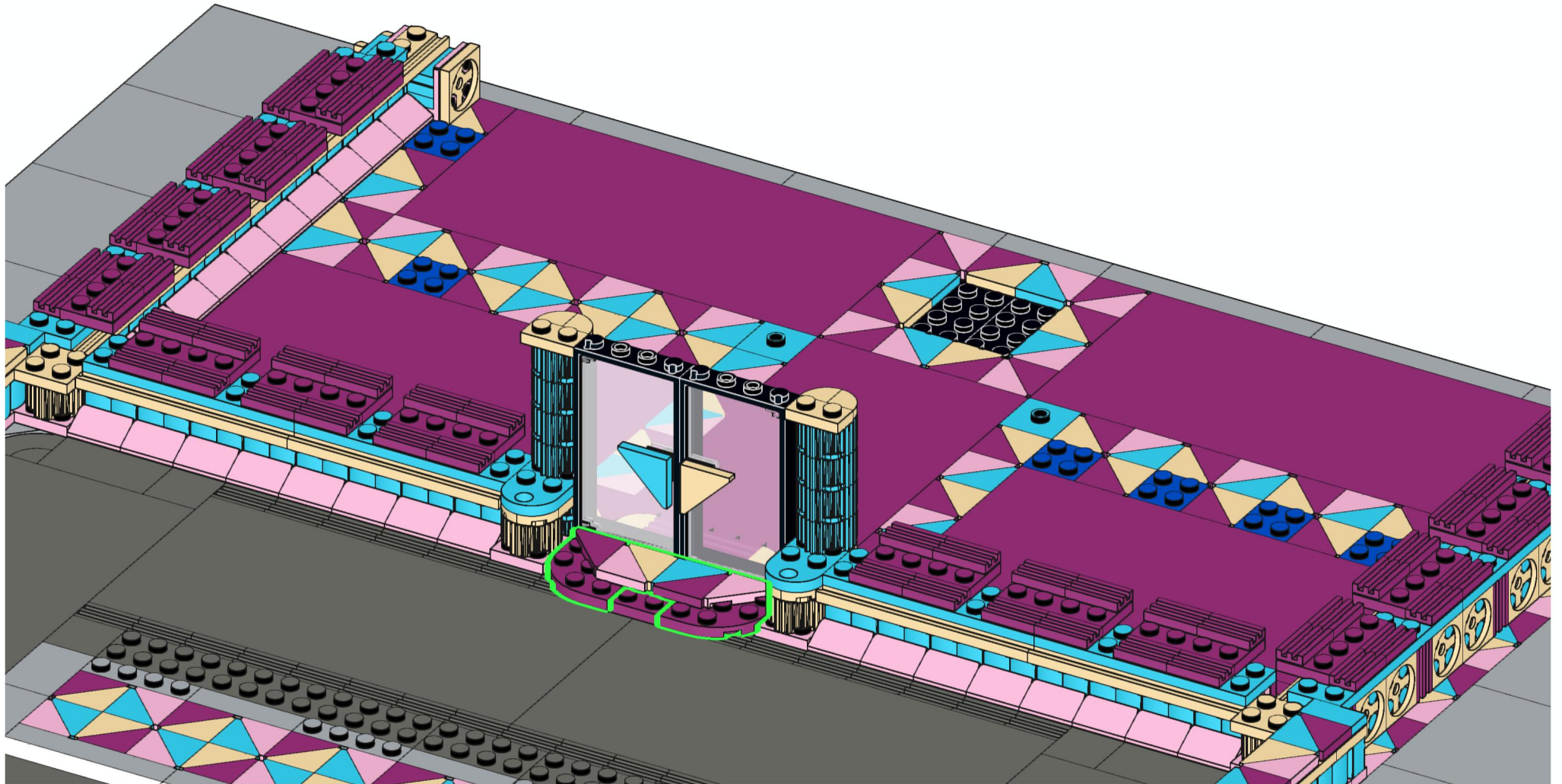
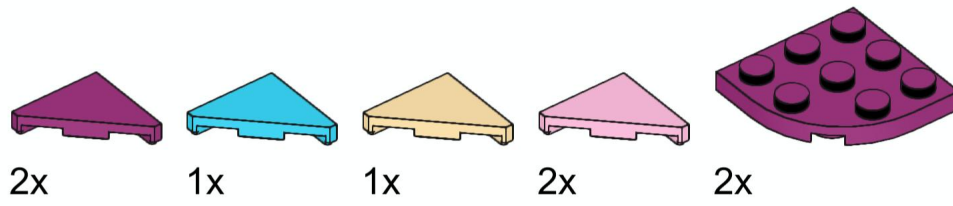

# 175

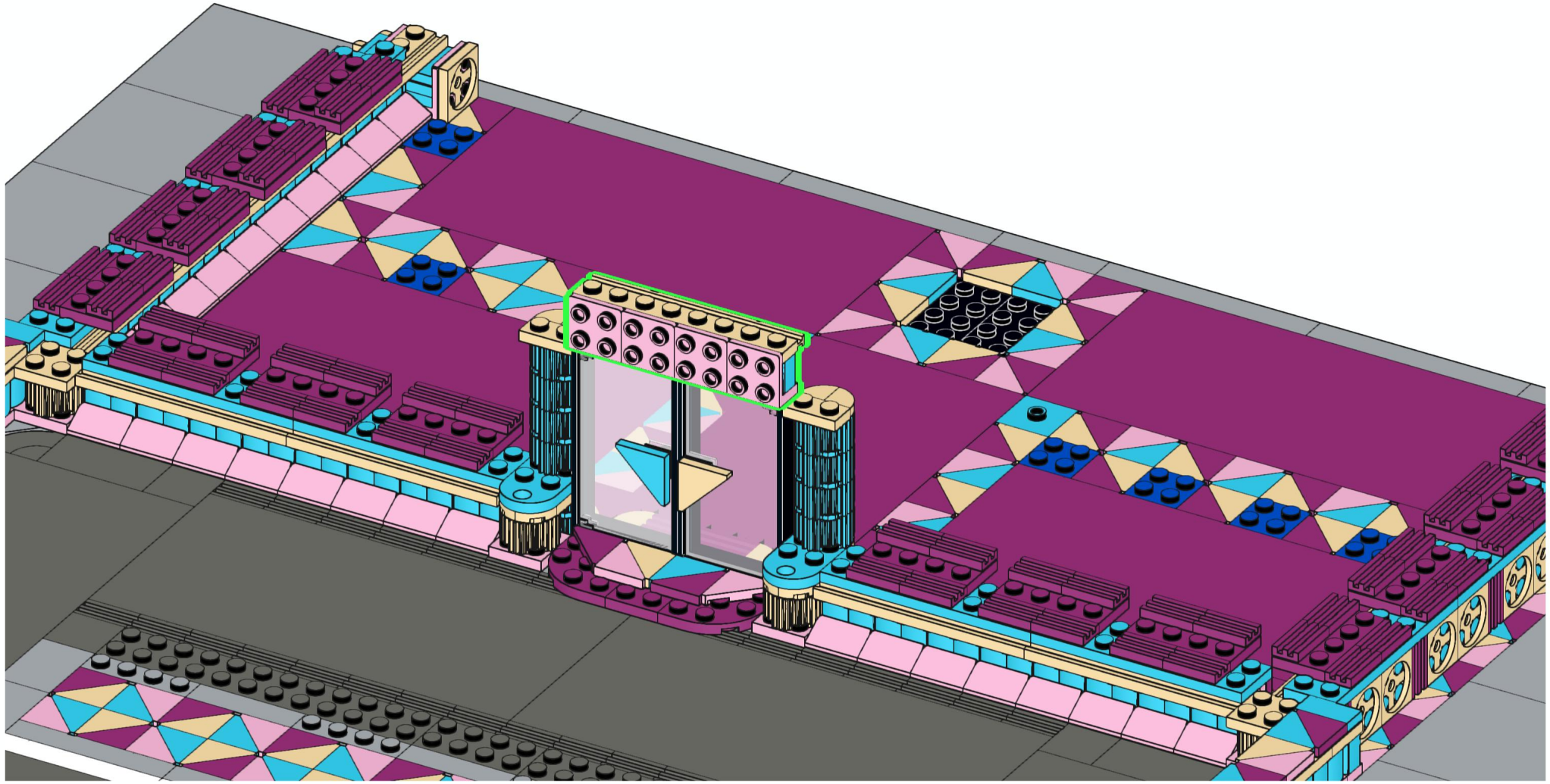
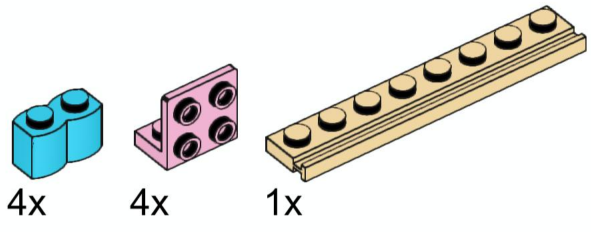



# 176



12x

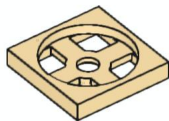



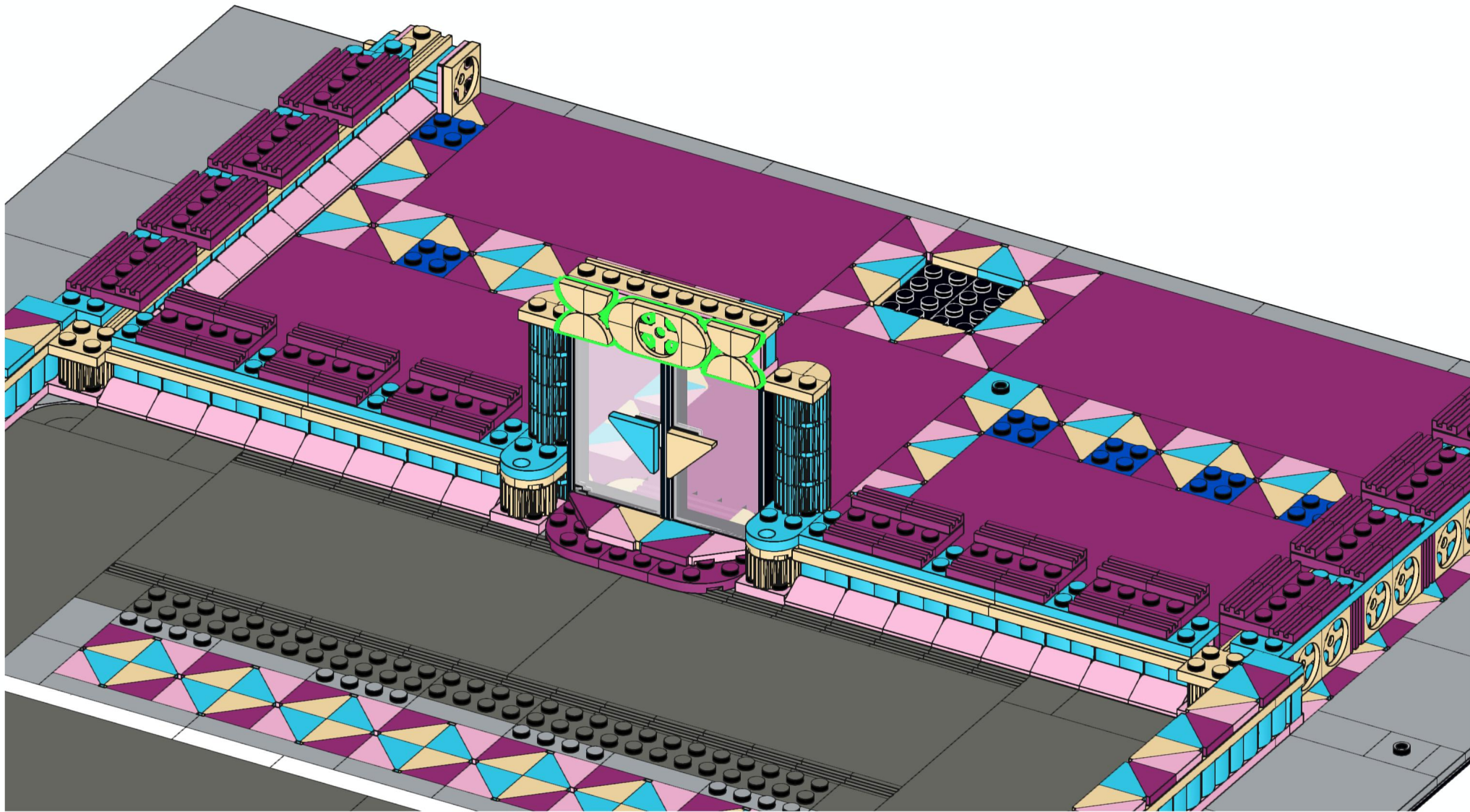

1x

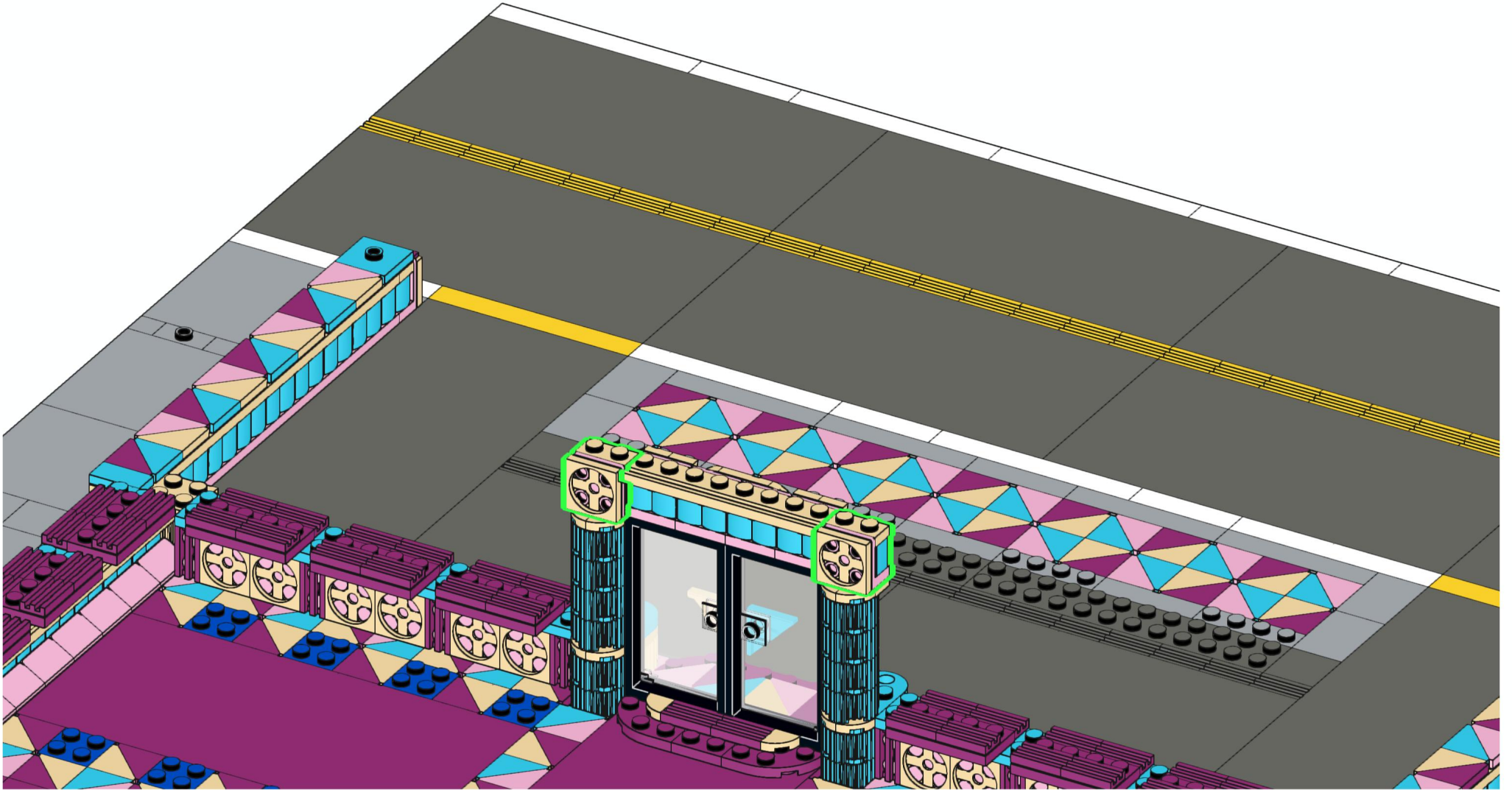
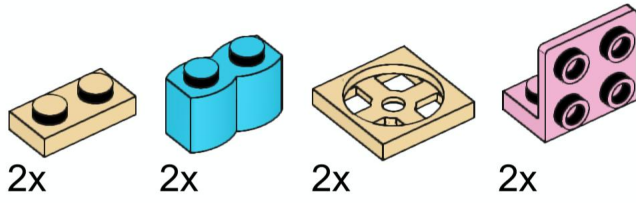

# 177



# 178

-  28x
-  28x
-  28x
-  28x

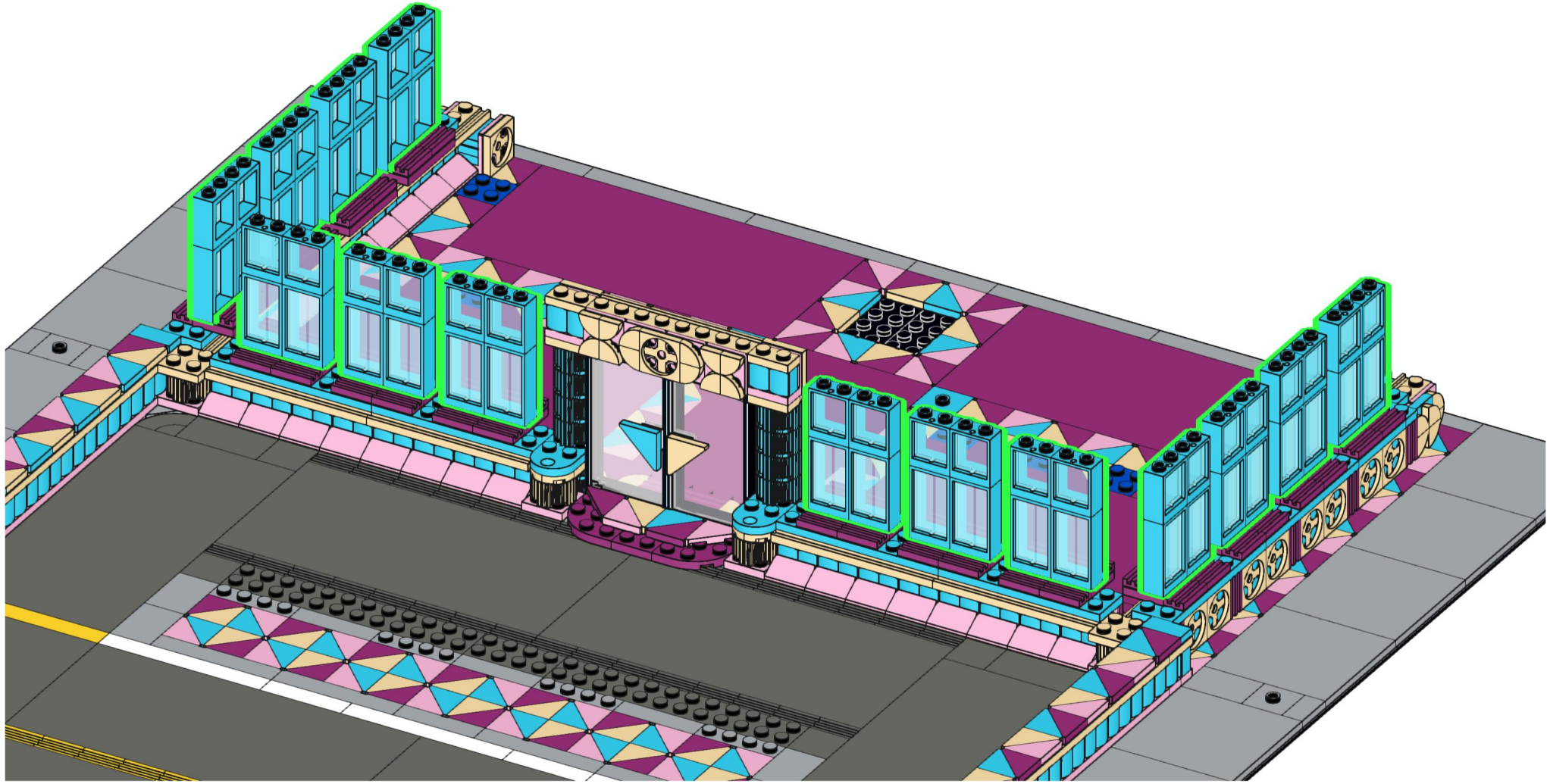

# 179

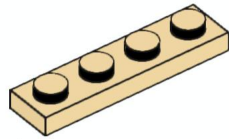

14x

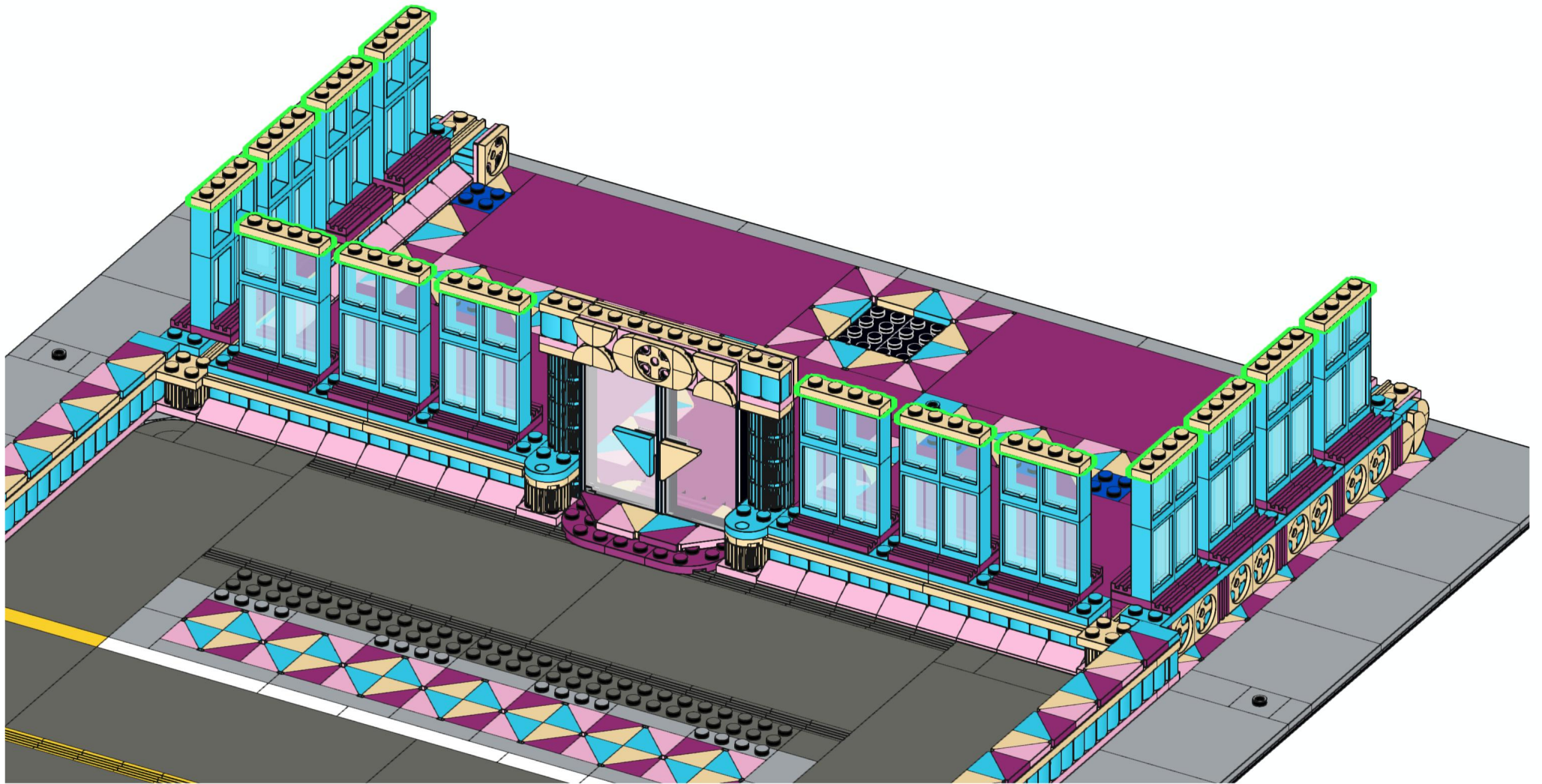

# 180

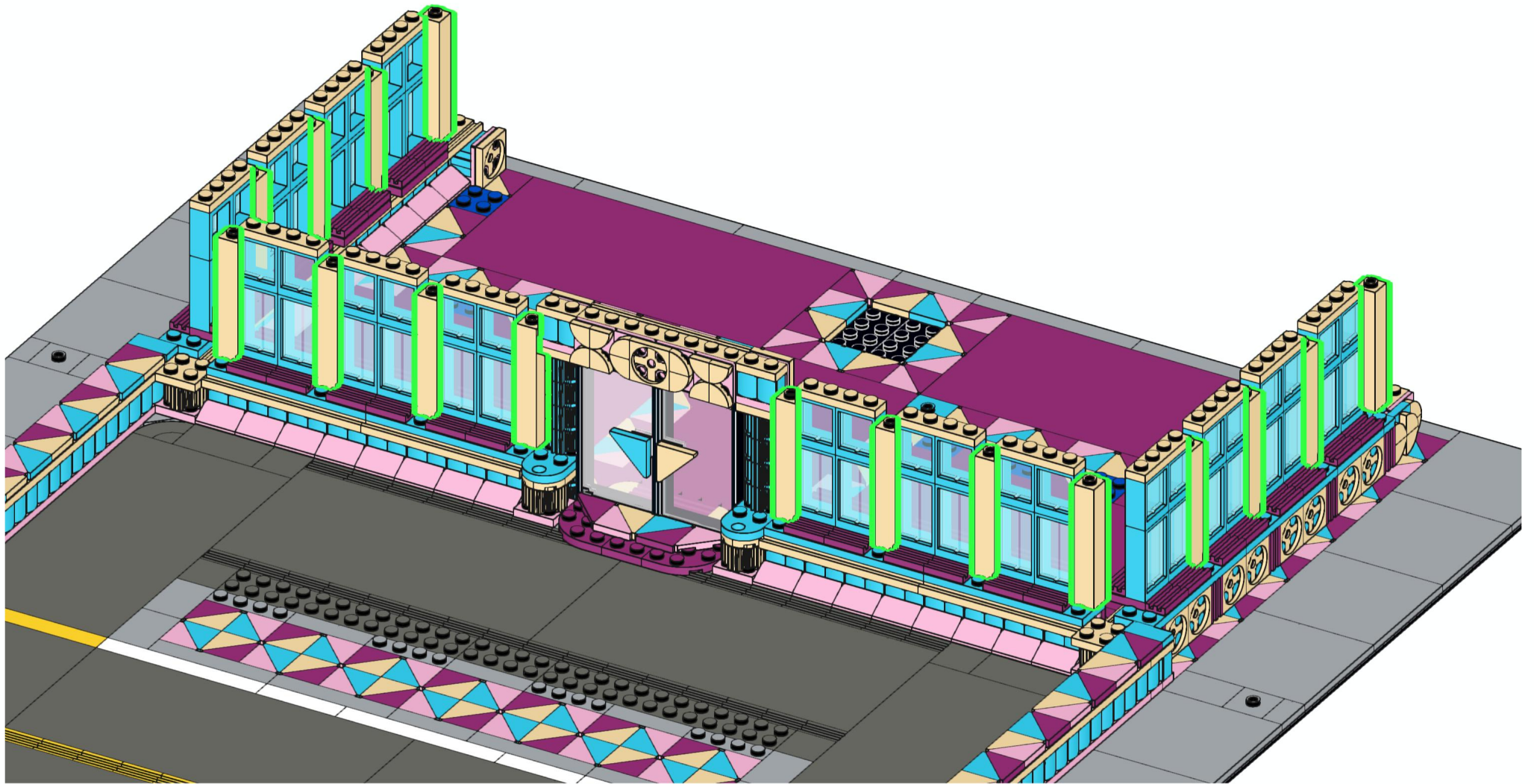
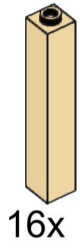





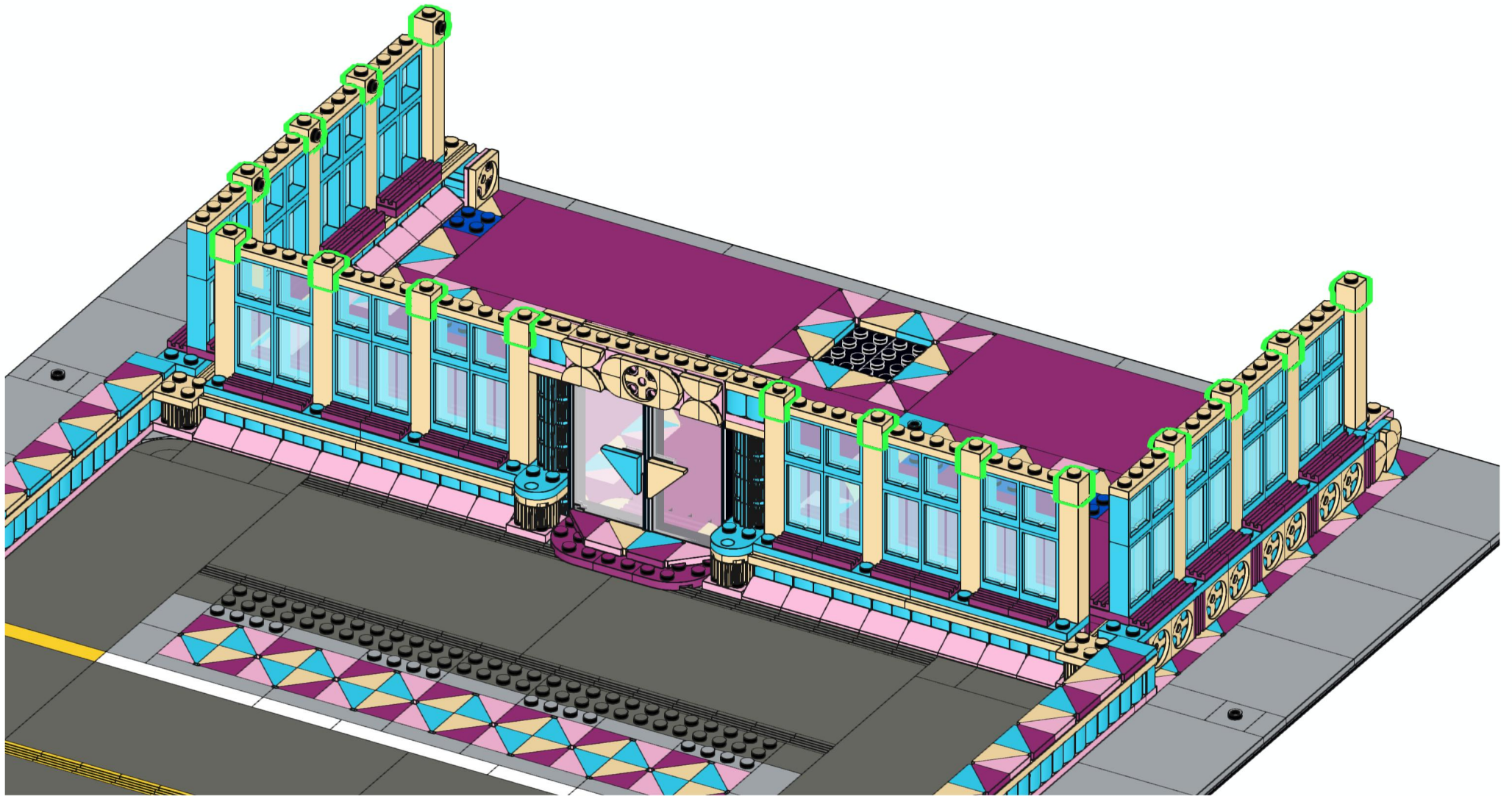

# 181



16x

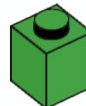

# 182

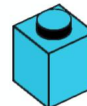
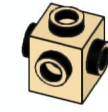
- 4x 
- 2x 
- 2x 
- 2x 
- 2x 
- 2x 
- 2x 
- 2x 
- 6x 

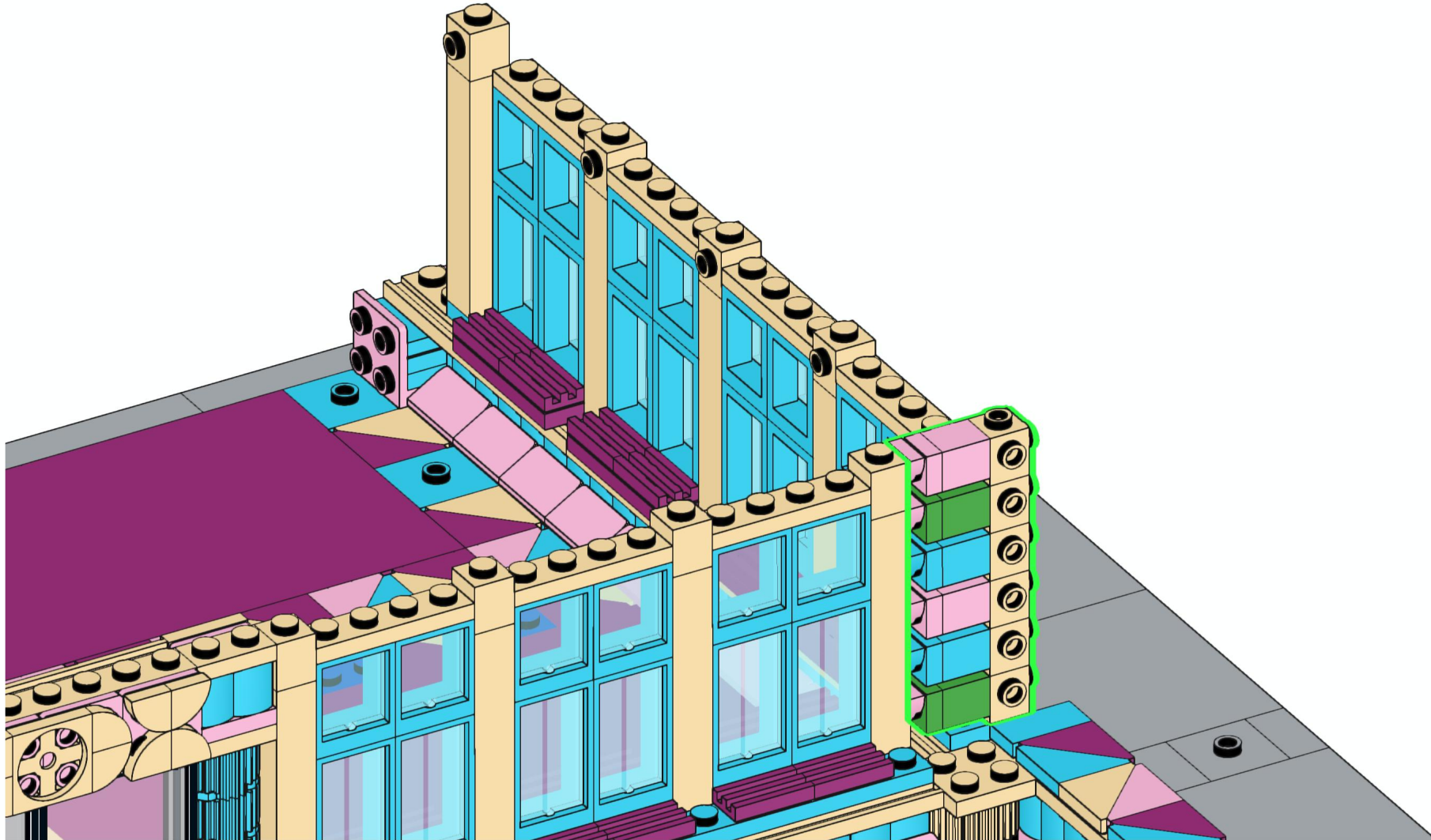

# 183

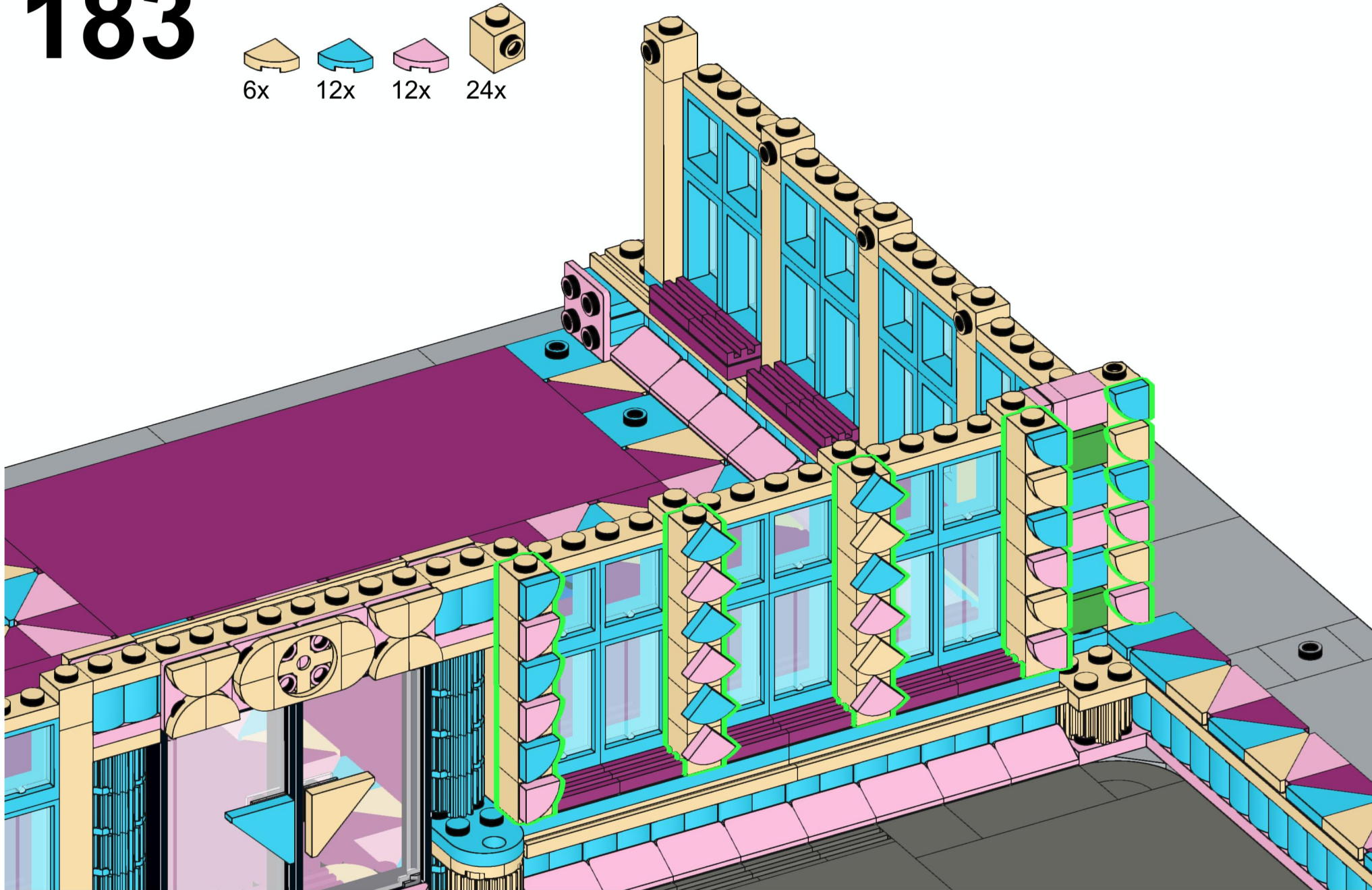
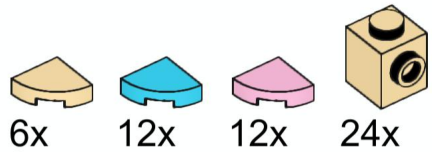



# 184

8x

8x

8x

18x

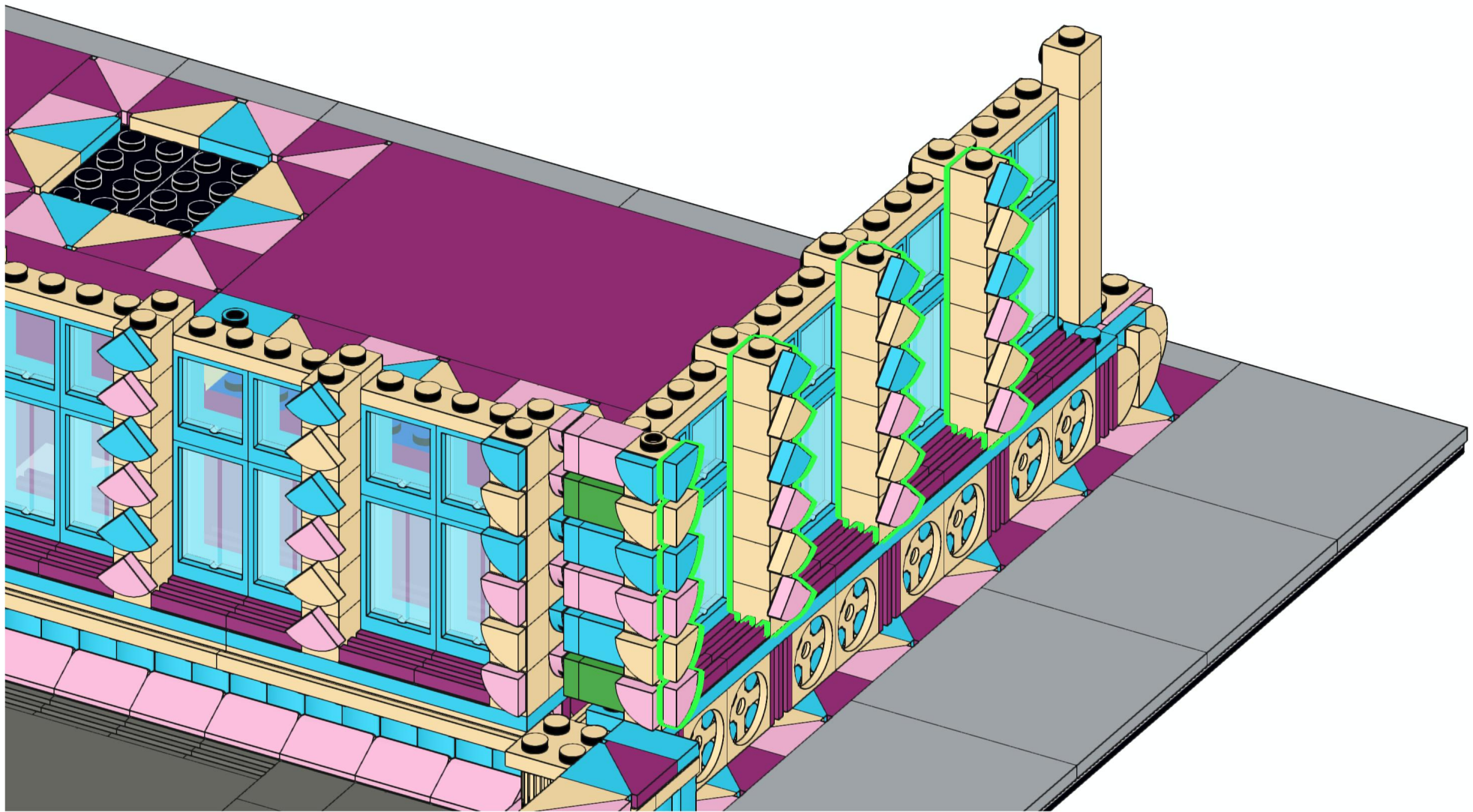

# 185



4x



4x



4x



6x



# 186

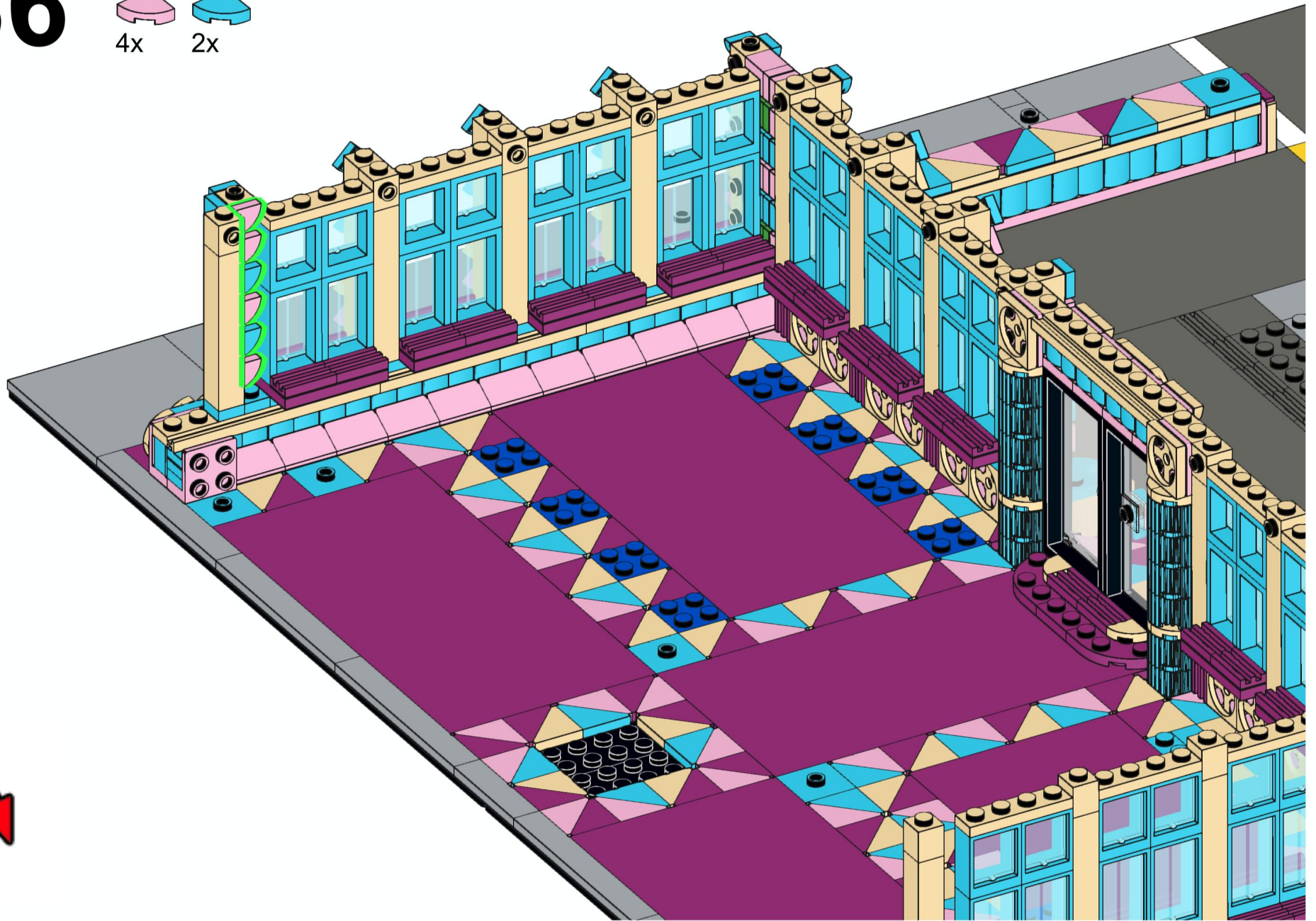
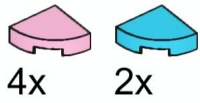



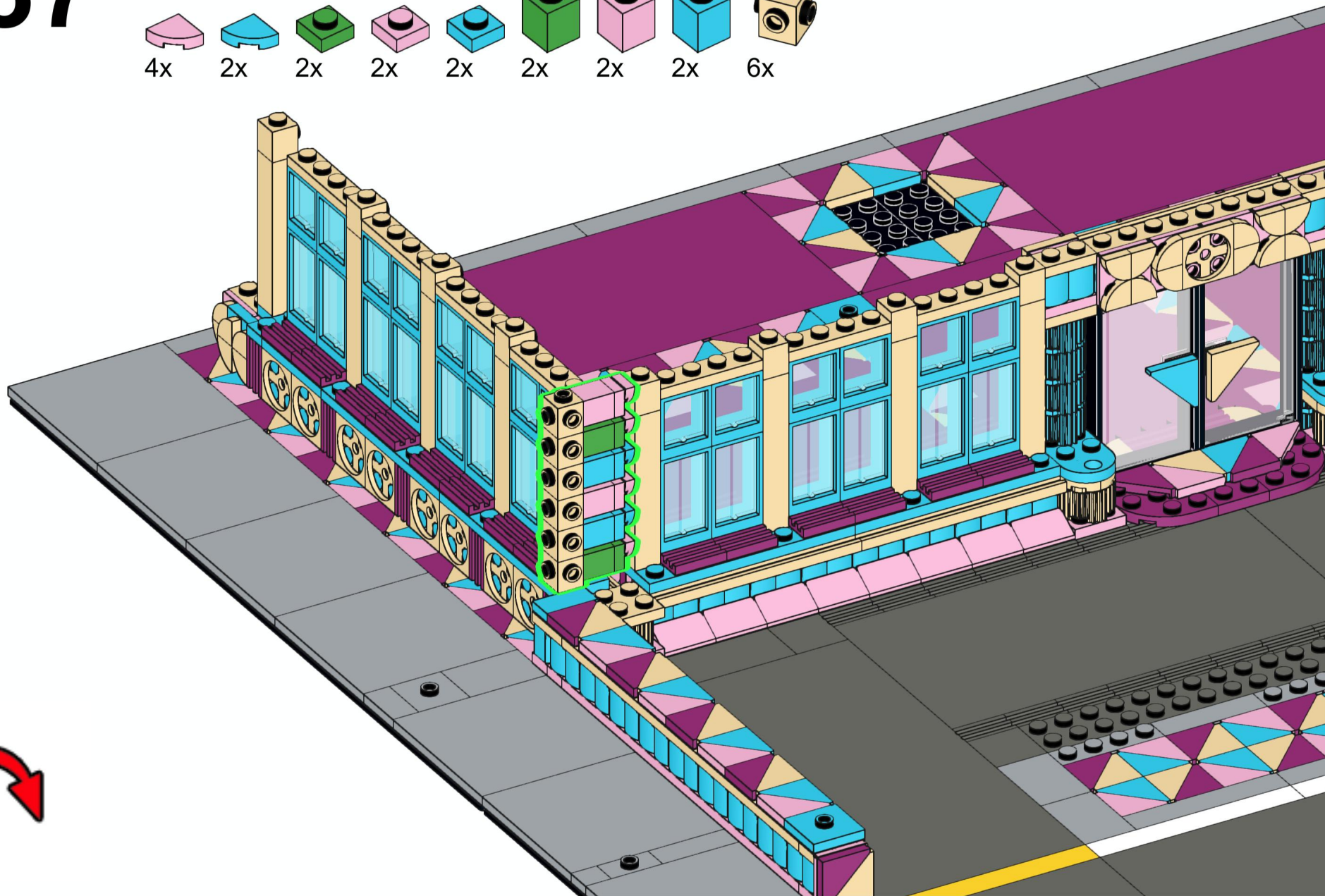
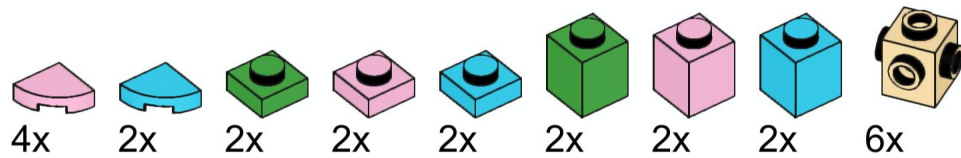

# 187

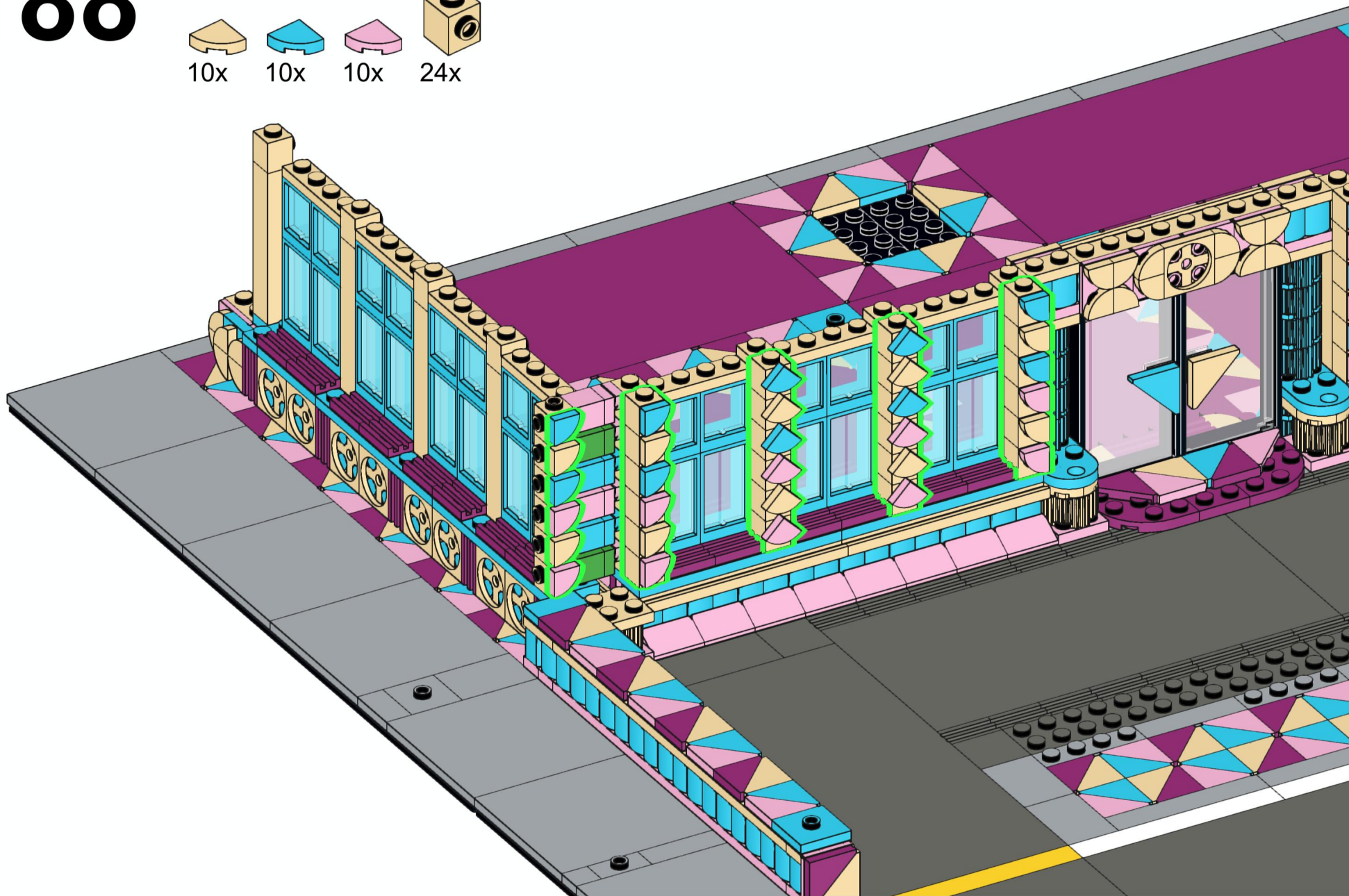
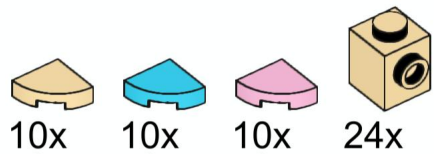

# 188

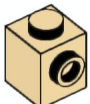

# 189

-  10x
-  16x
-  16x
-  18x
-  6x

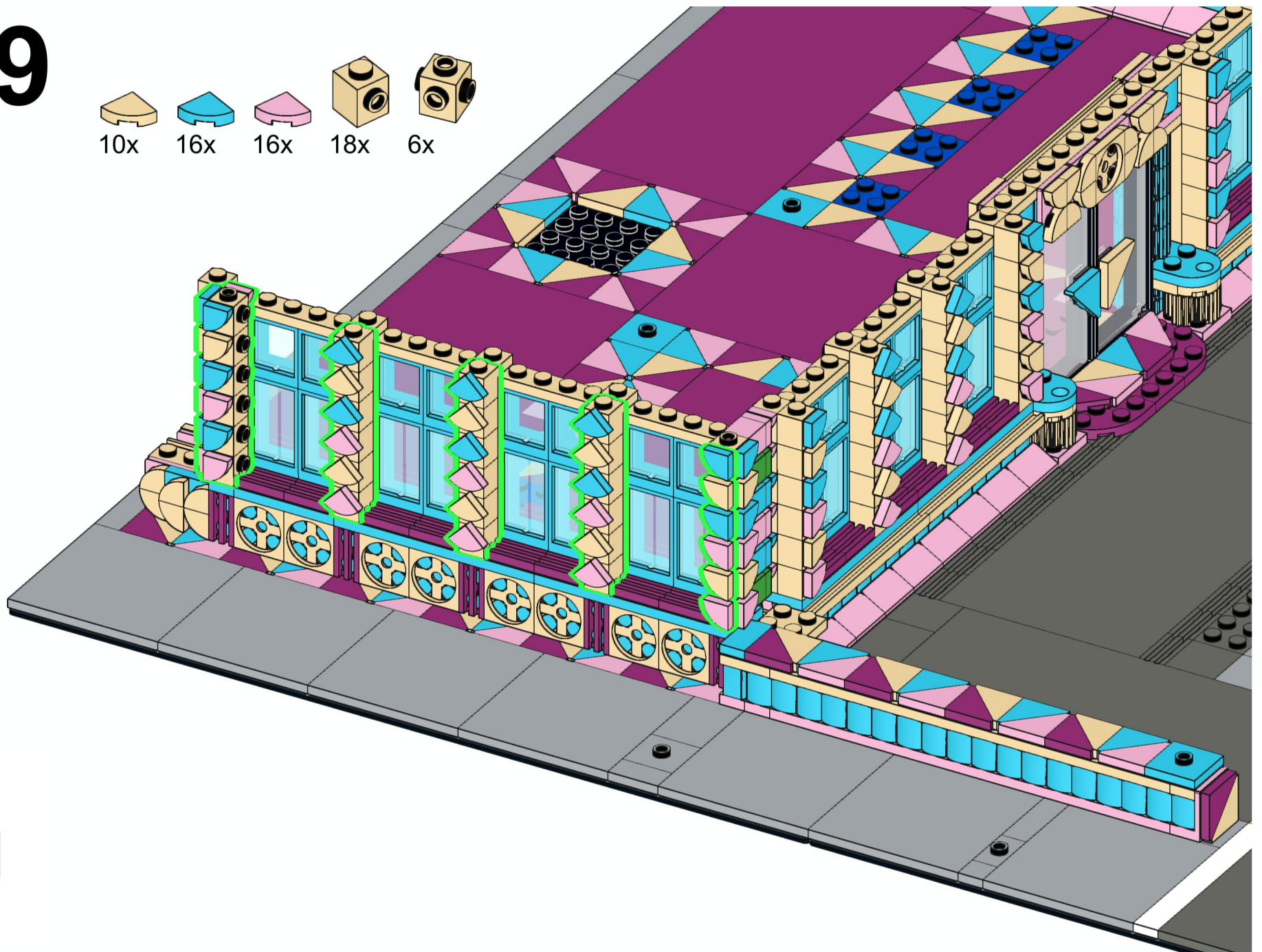

# 190



26x

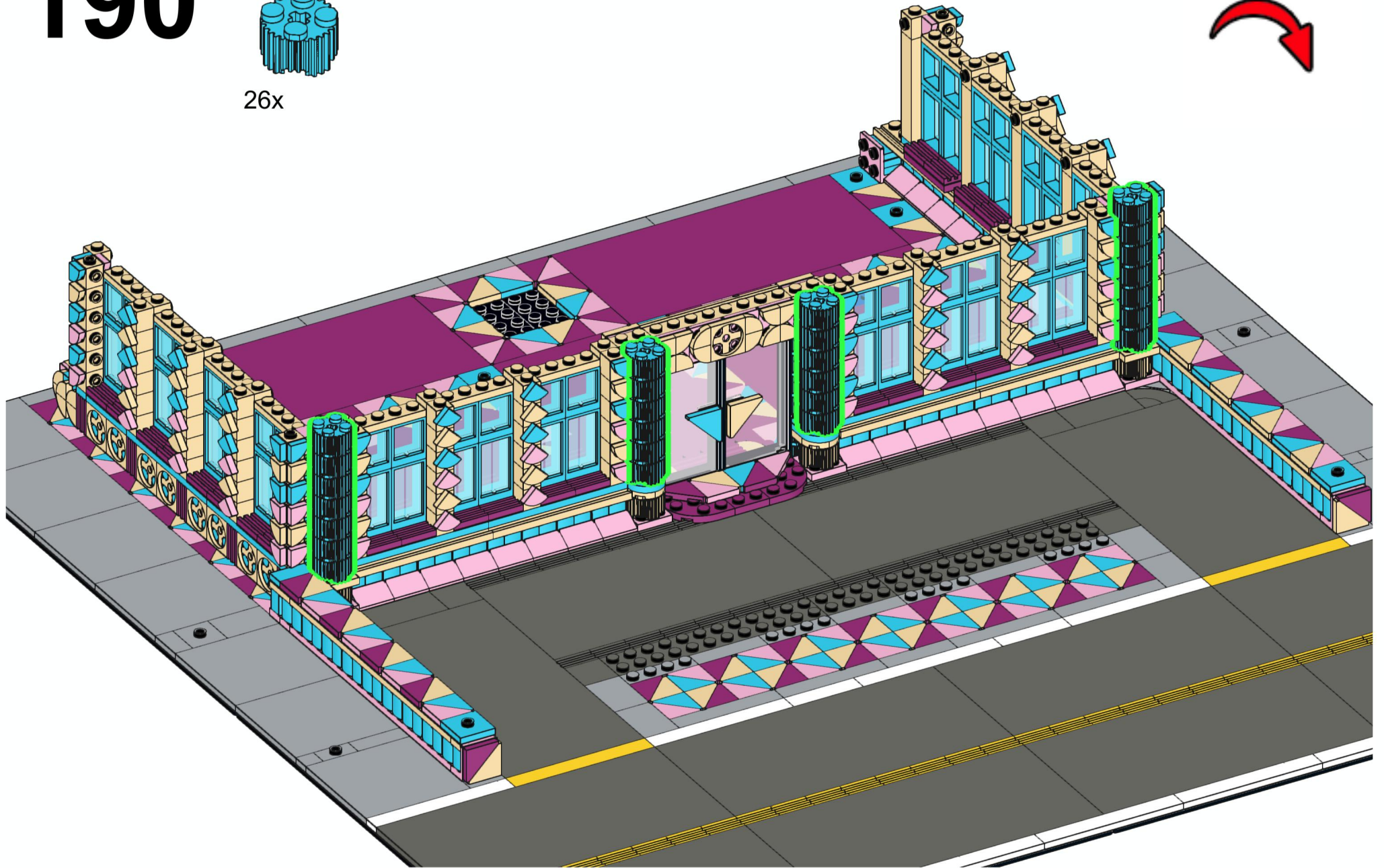

# 191

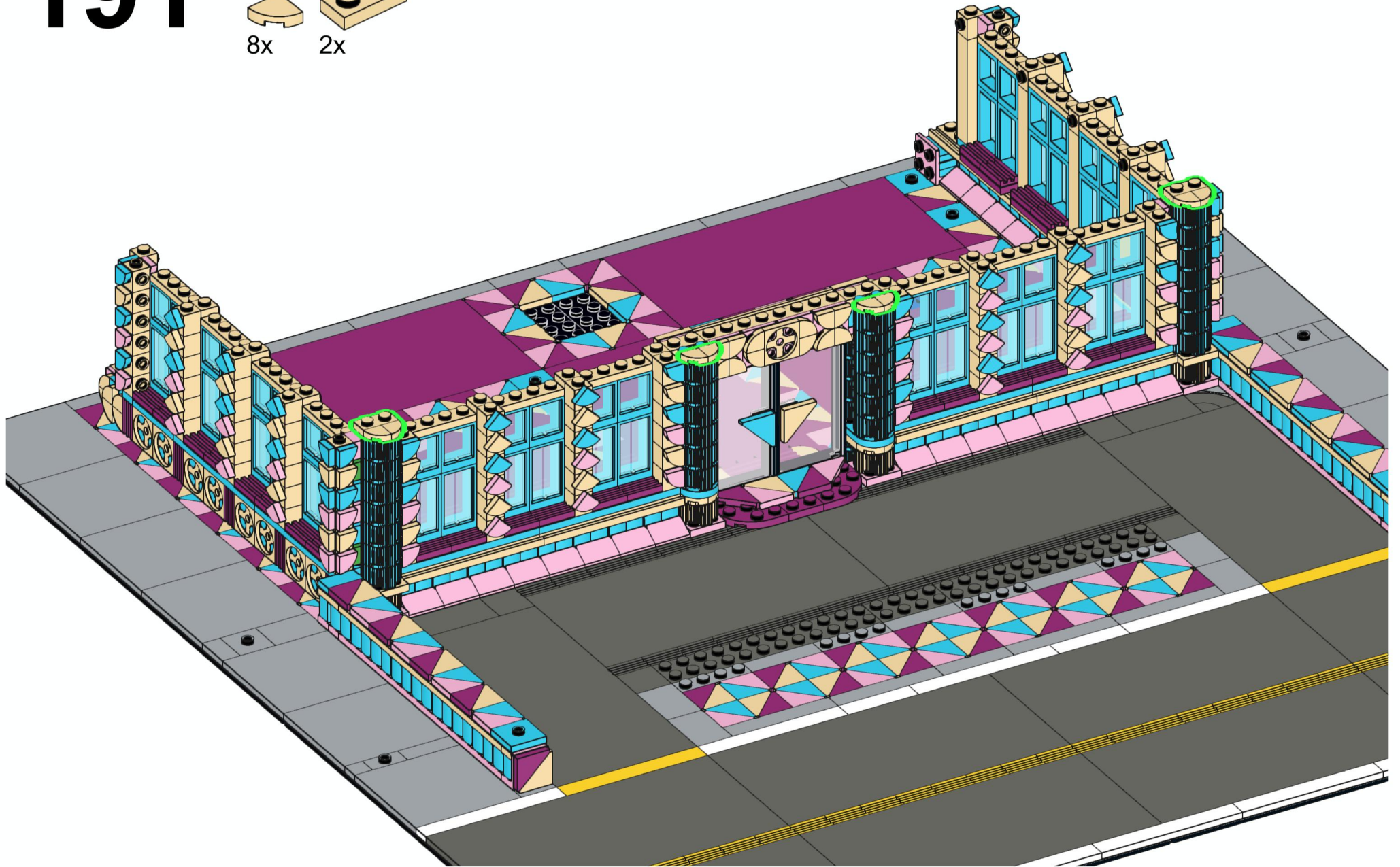
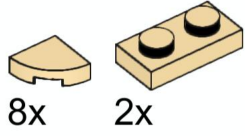



# 192



34x

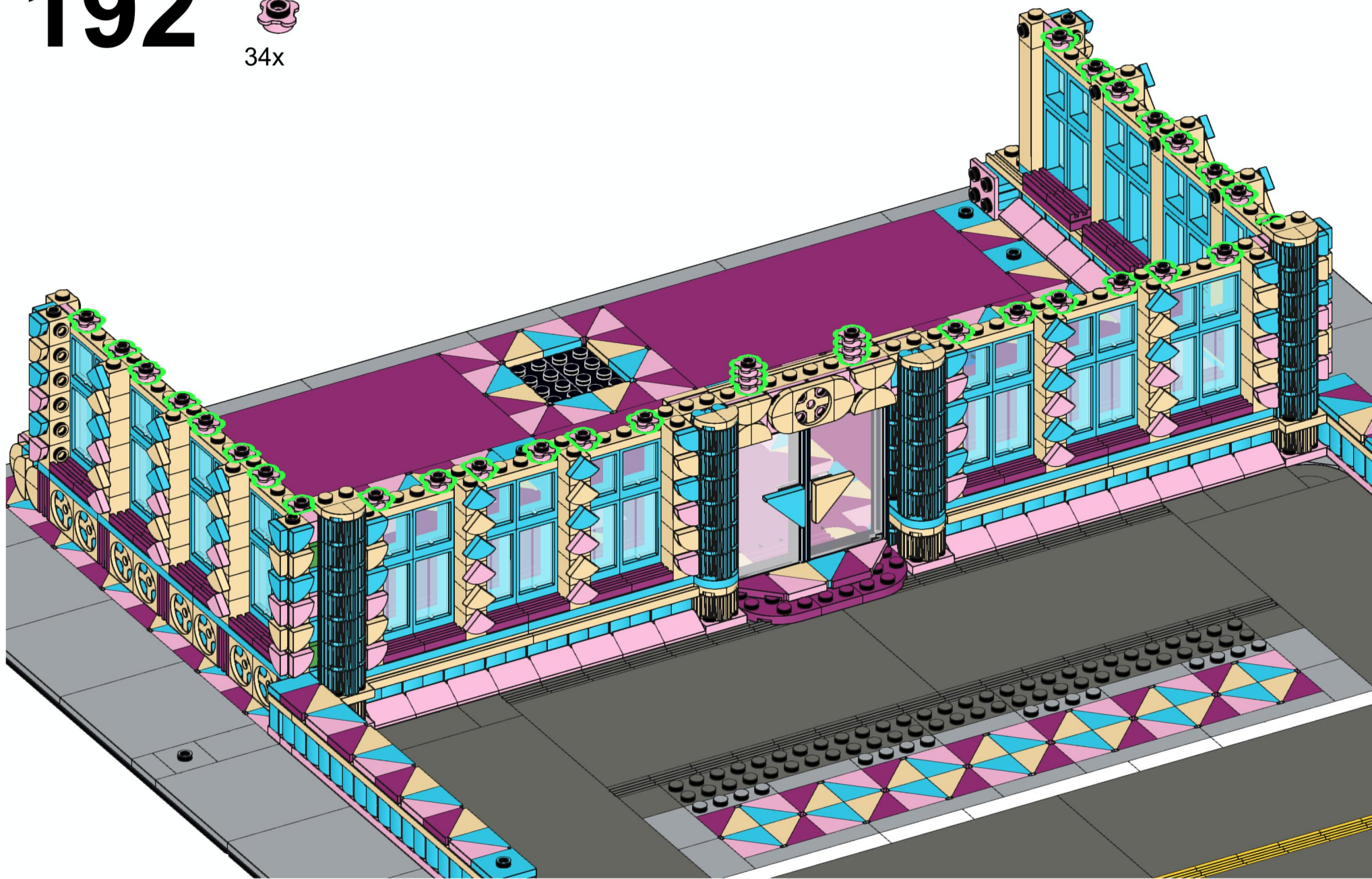

# 193



14x



7x

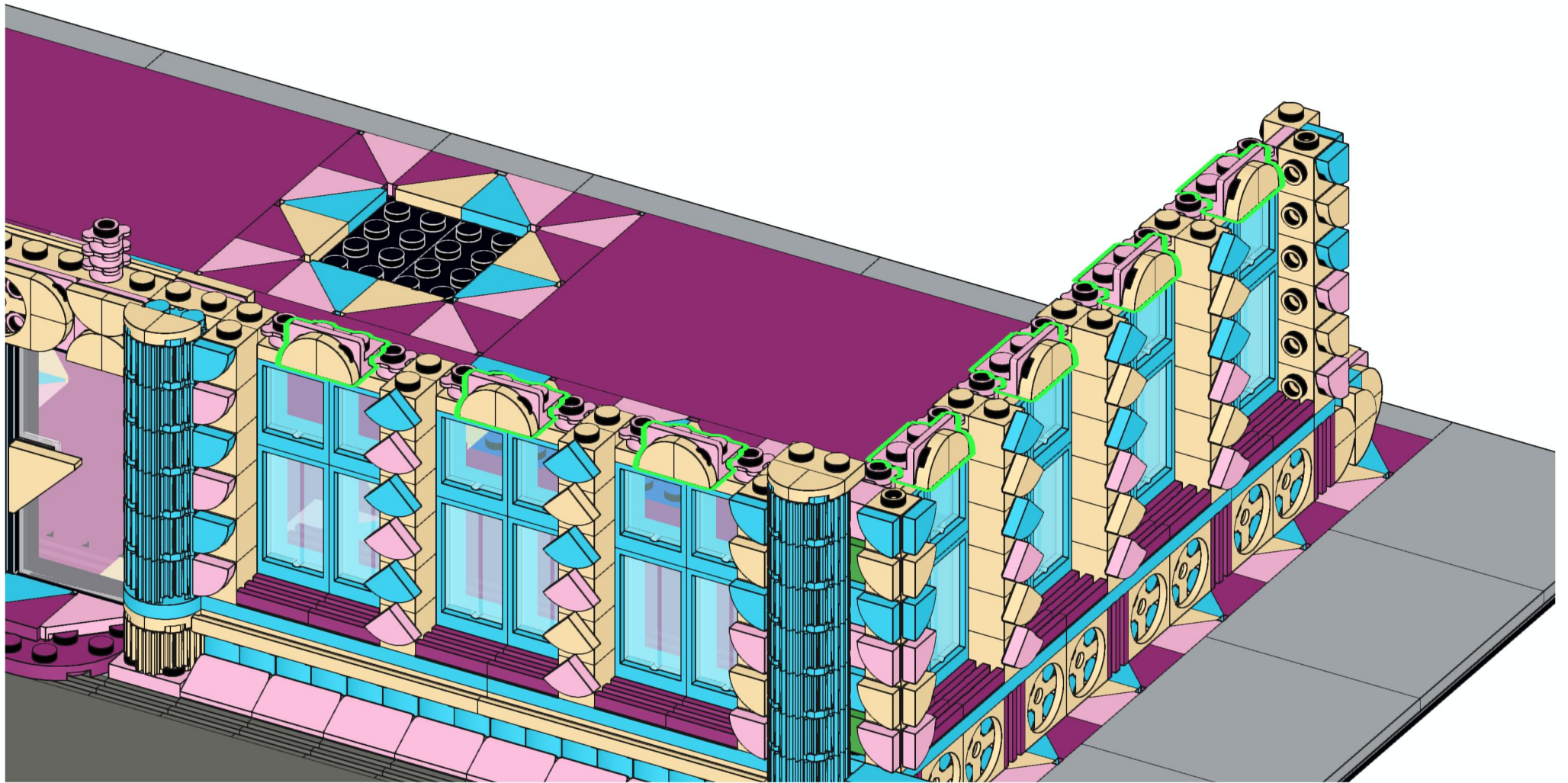

# 194



14x

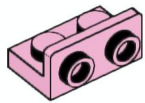

7x

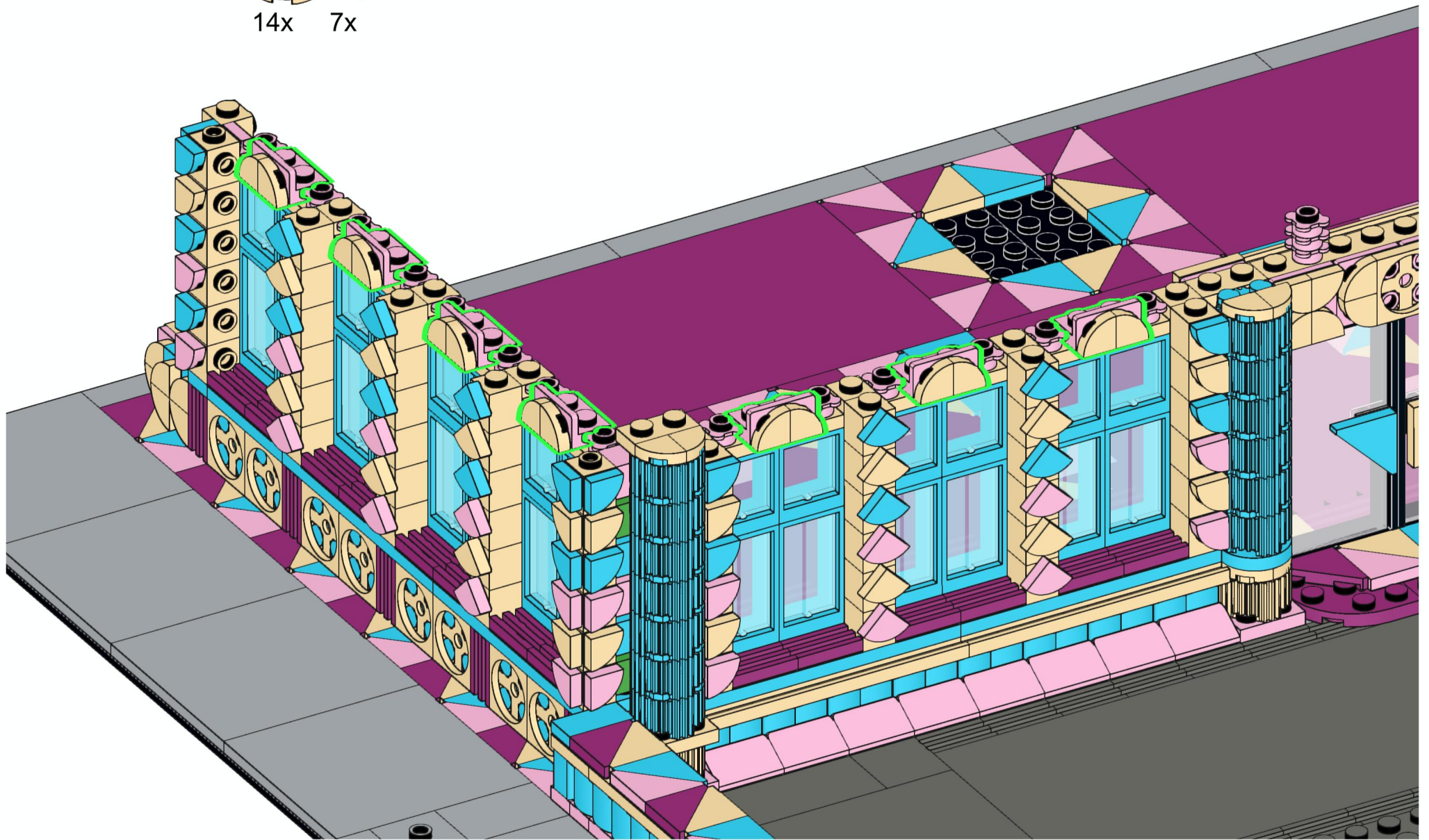

# 195



8x



8x



# 196



8x



8x

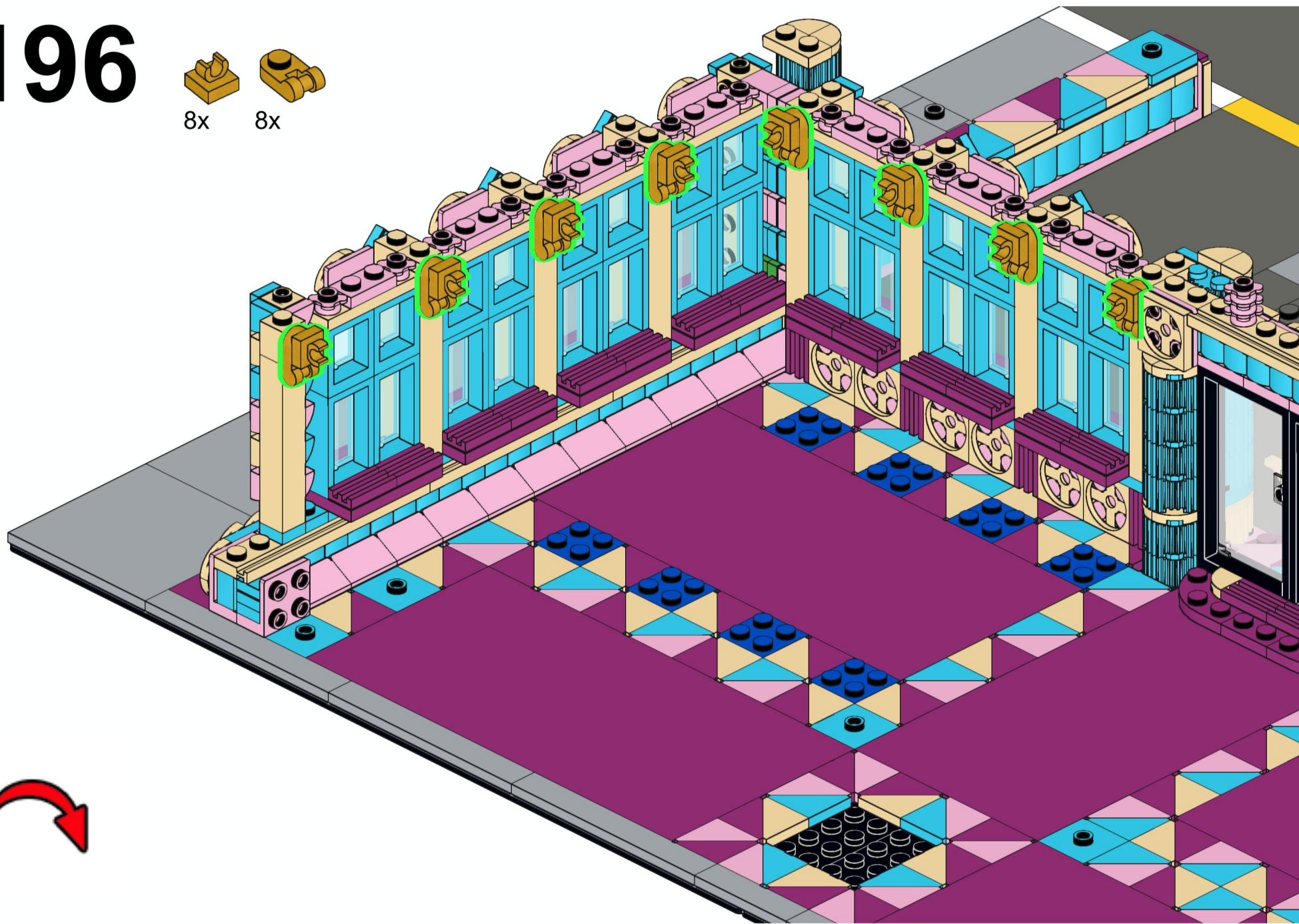

# 197

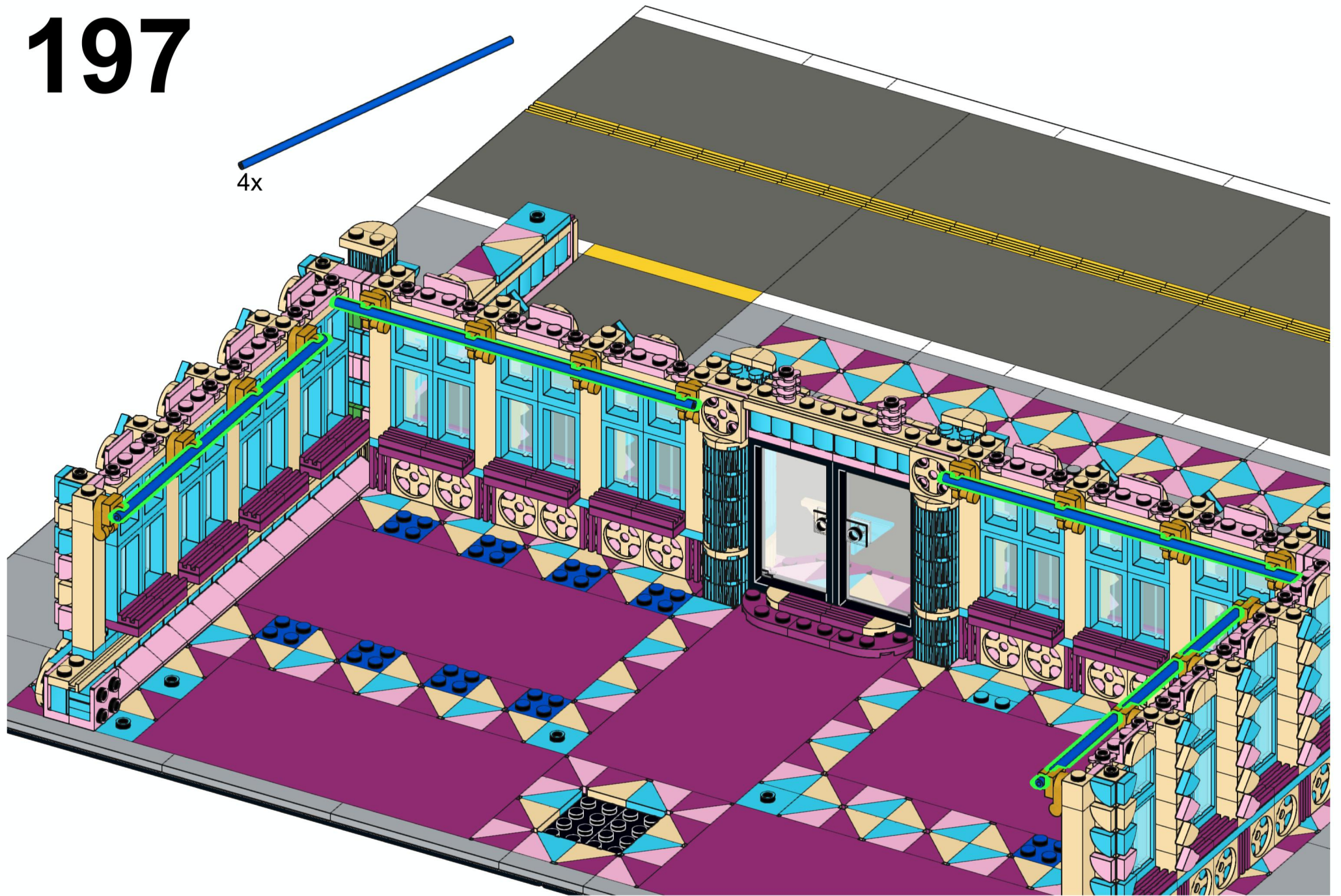

# 198

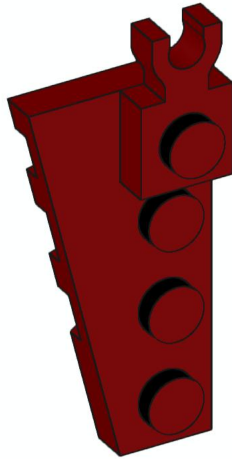
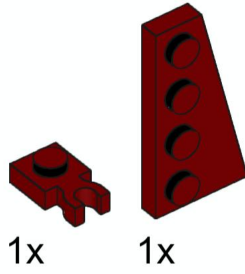

# 199

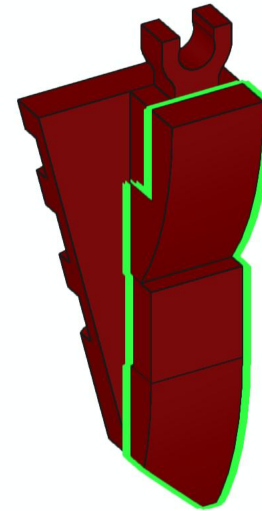
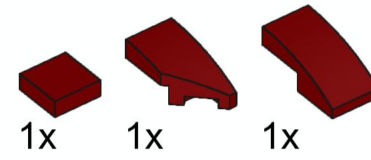

200

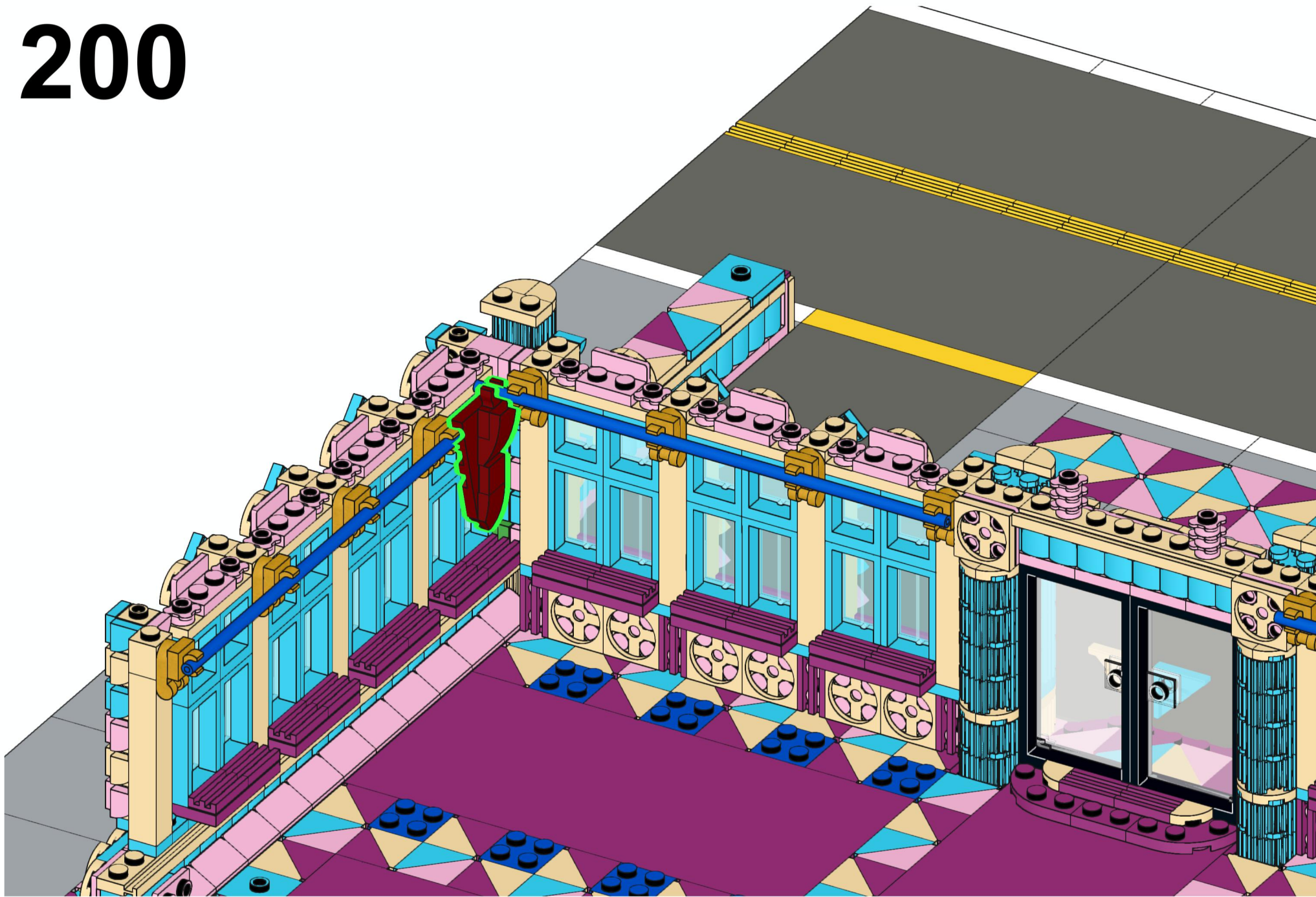



# 201

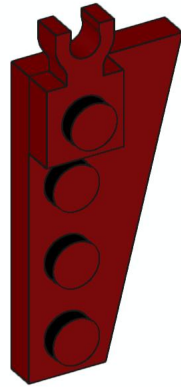
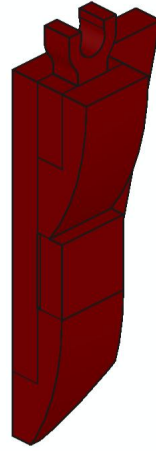
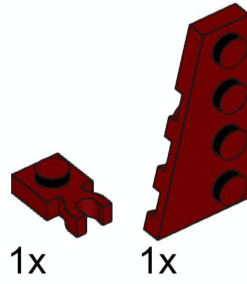

# 202

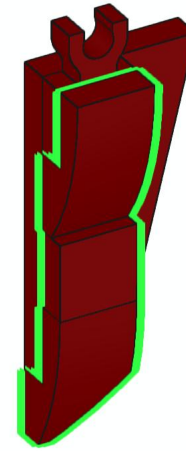
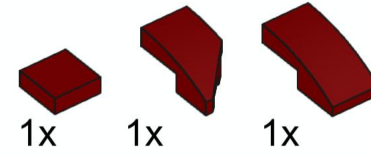

# 203

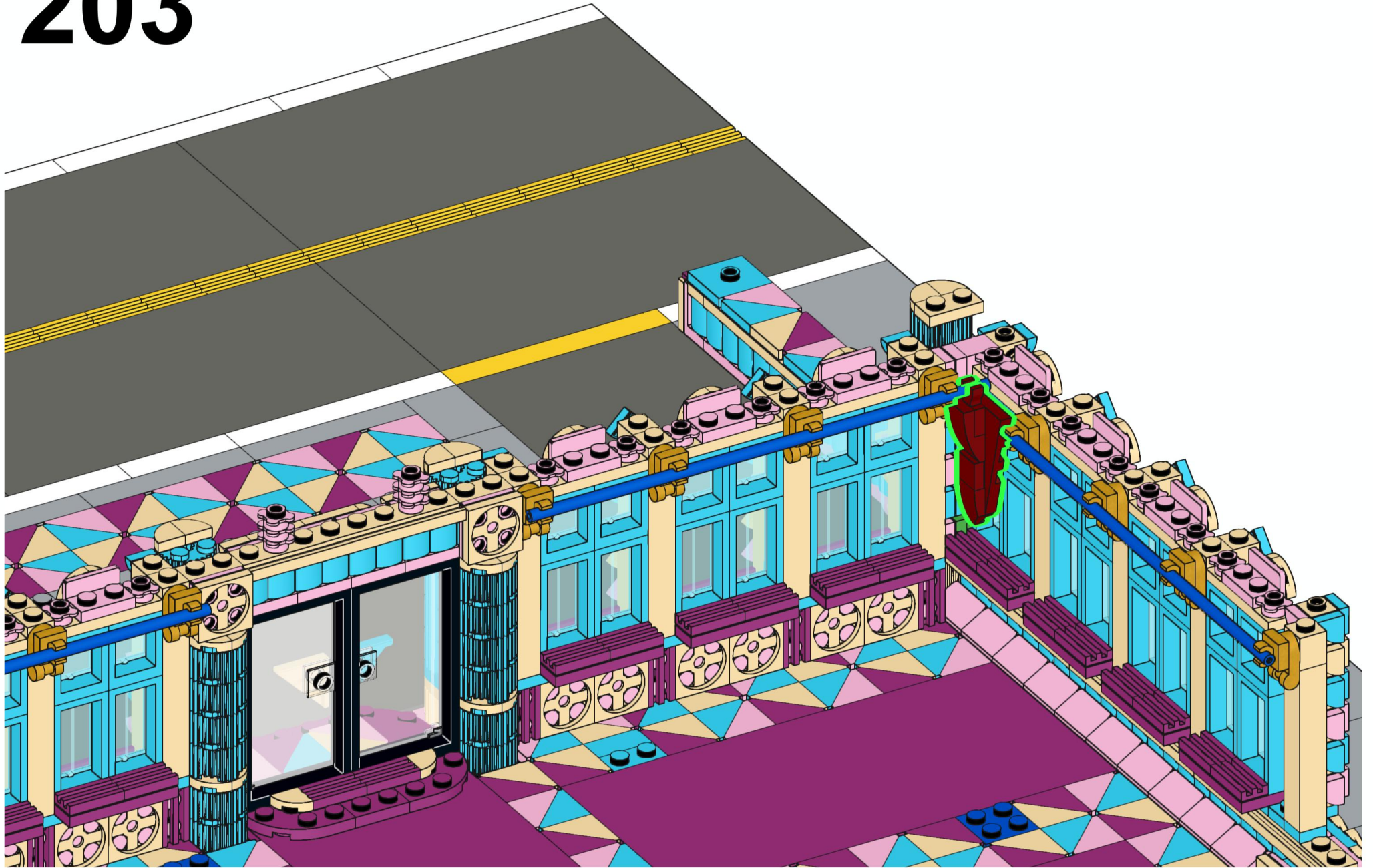

# 204

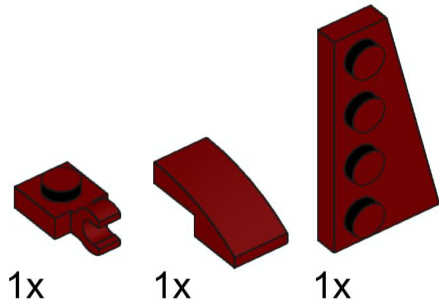

# 205

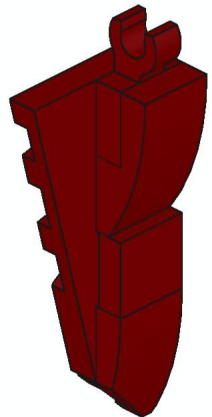
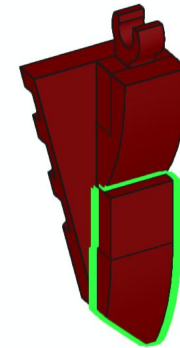
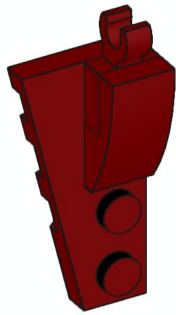
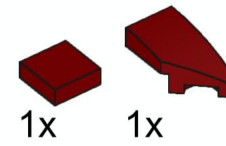

# X11

206

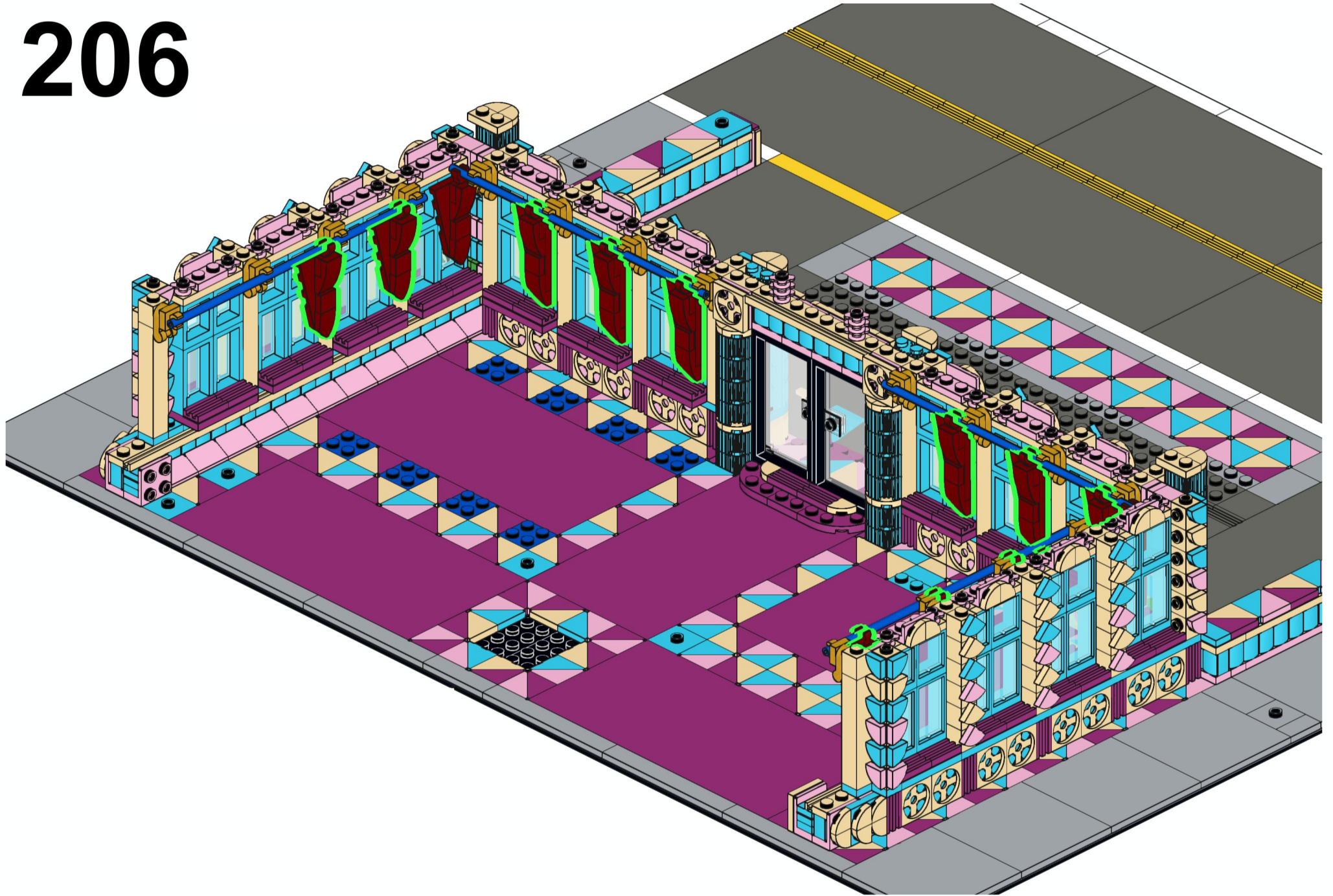

# 207

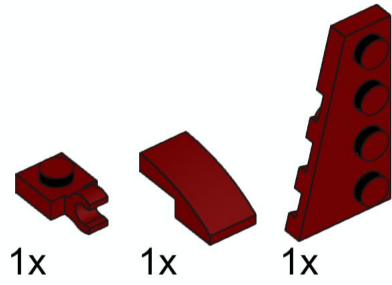

# 208

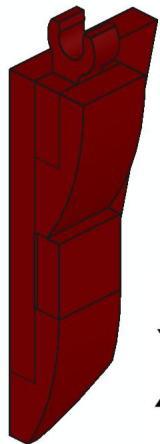
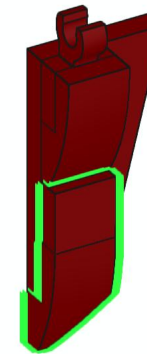
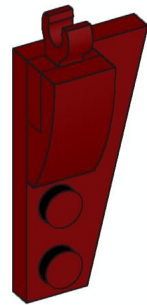
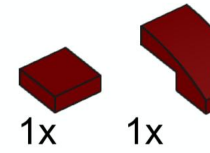

# X11

209

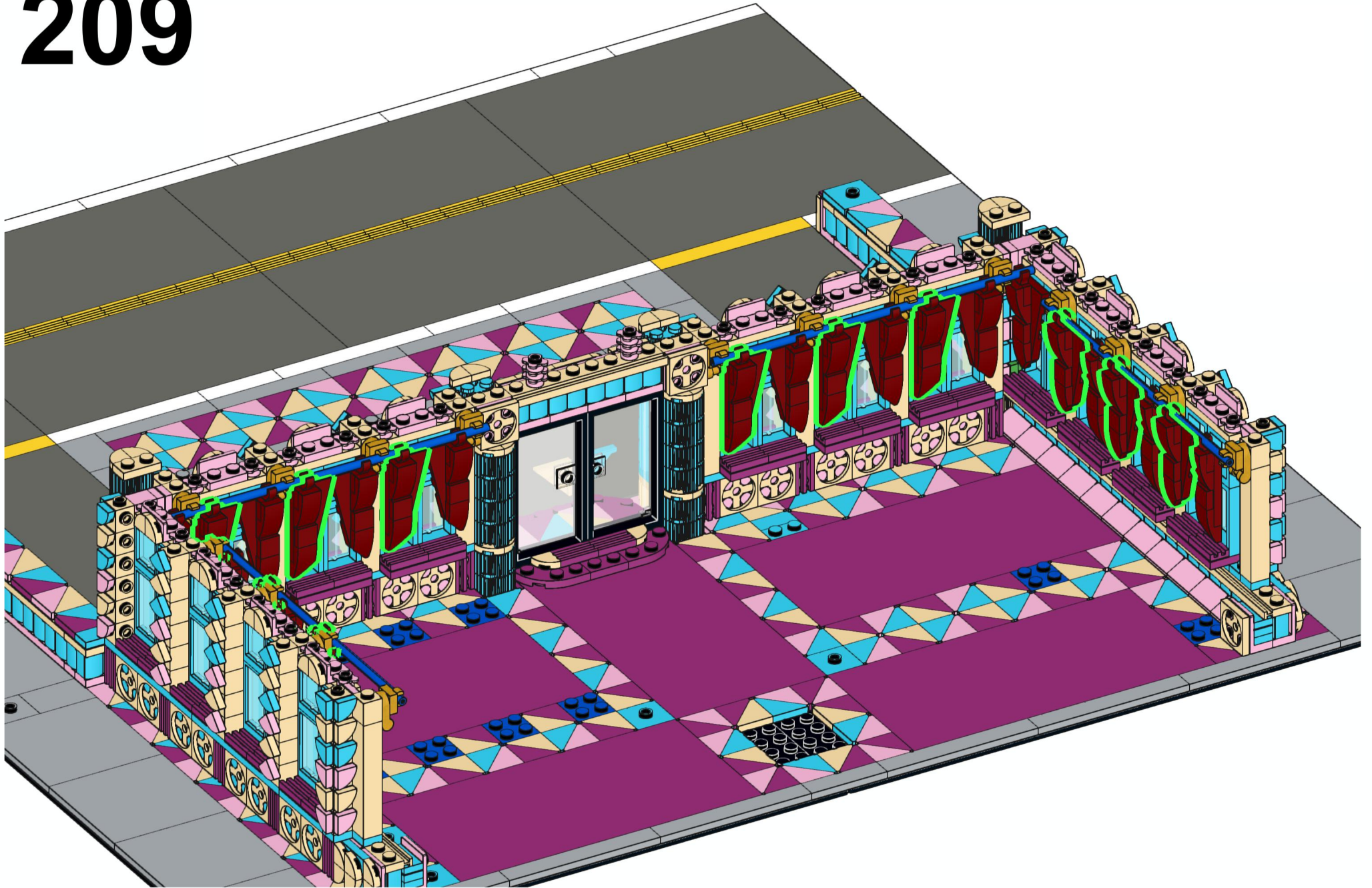

# 210

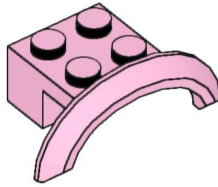

14x



# 211

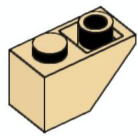

2x

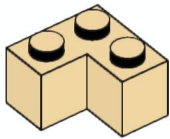

2x





# 212

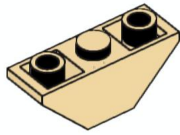

7x



# 213

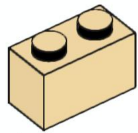

1x

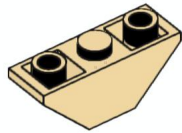

4x



# 214

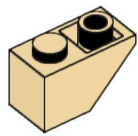

2x

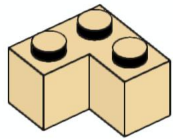

2x



# 215

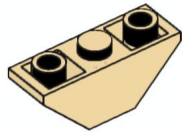

7x

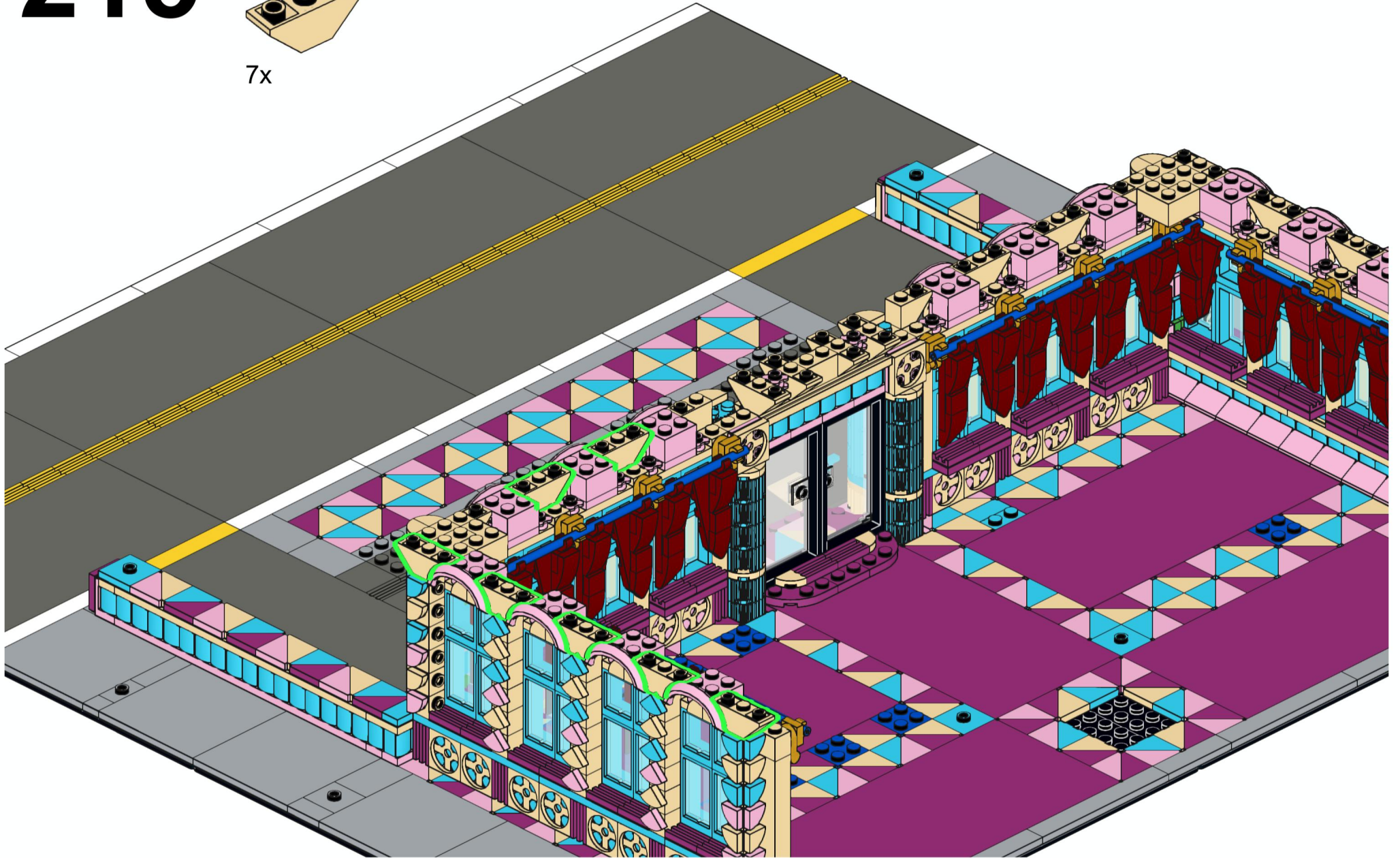

# 216

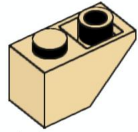

14x



# 217

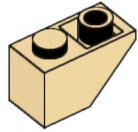

14x



# 218

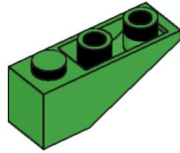

6x

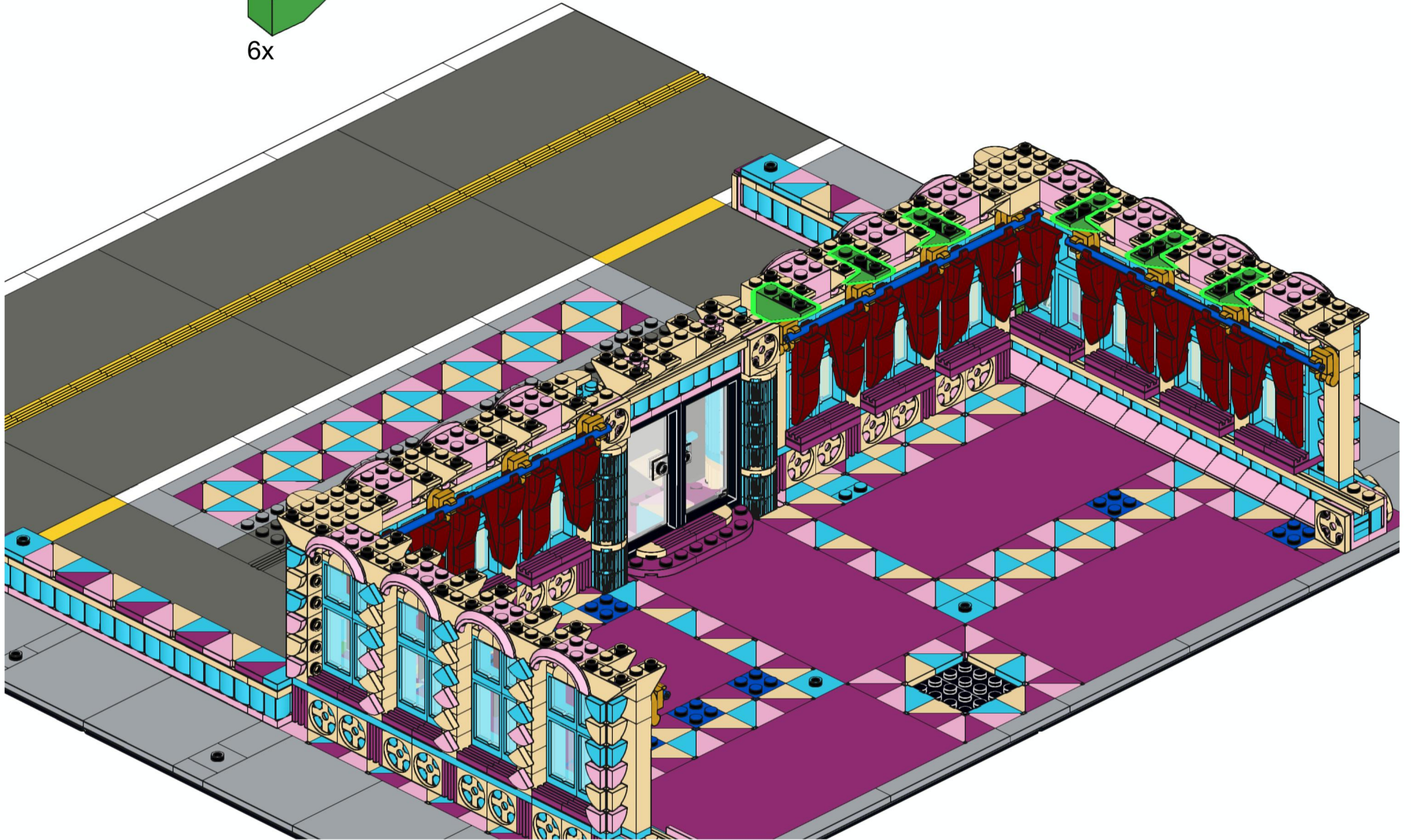

# 219

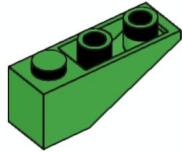

6x

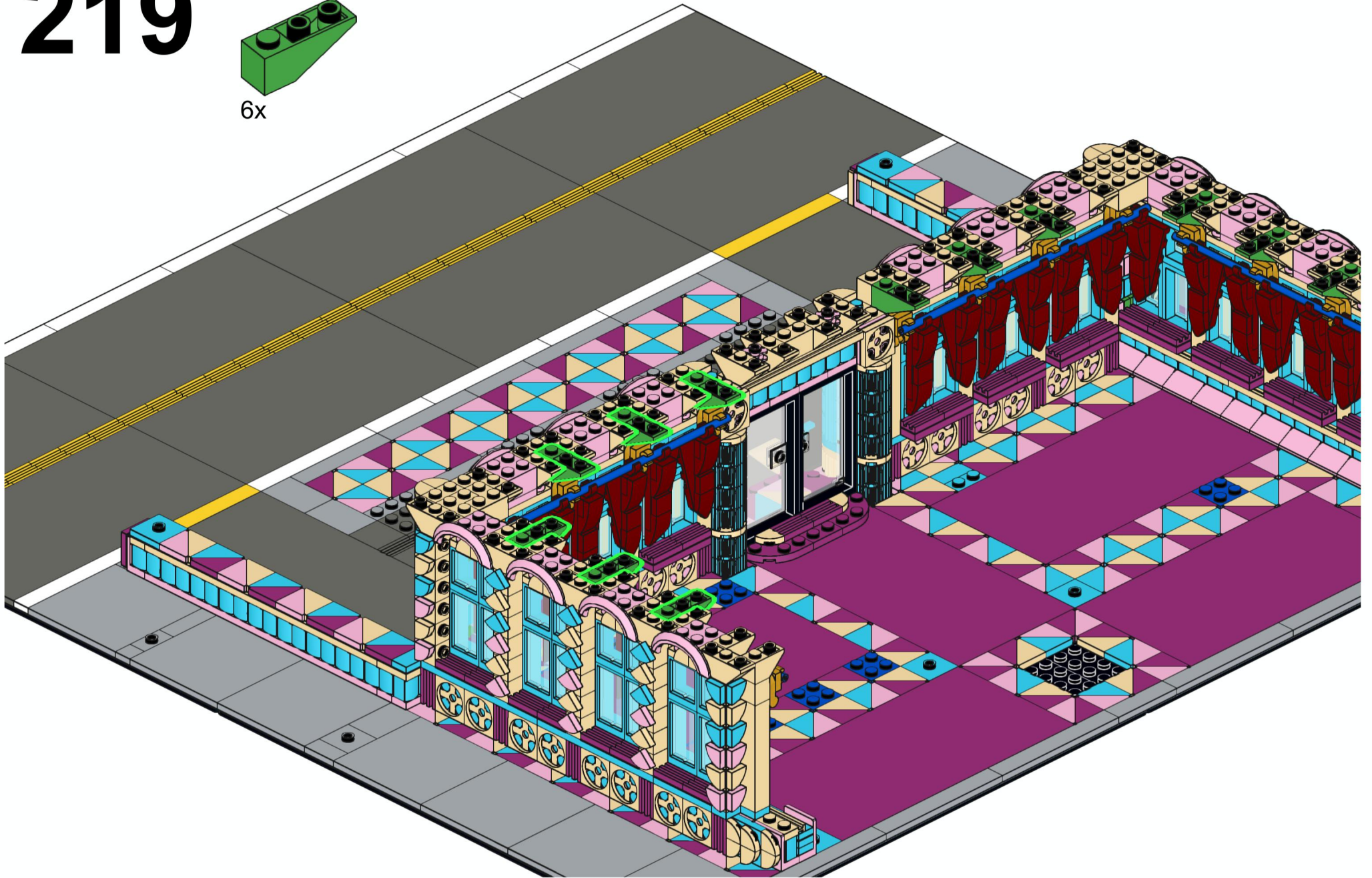



# 220

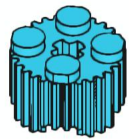

7x

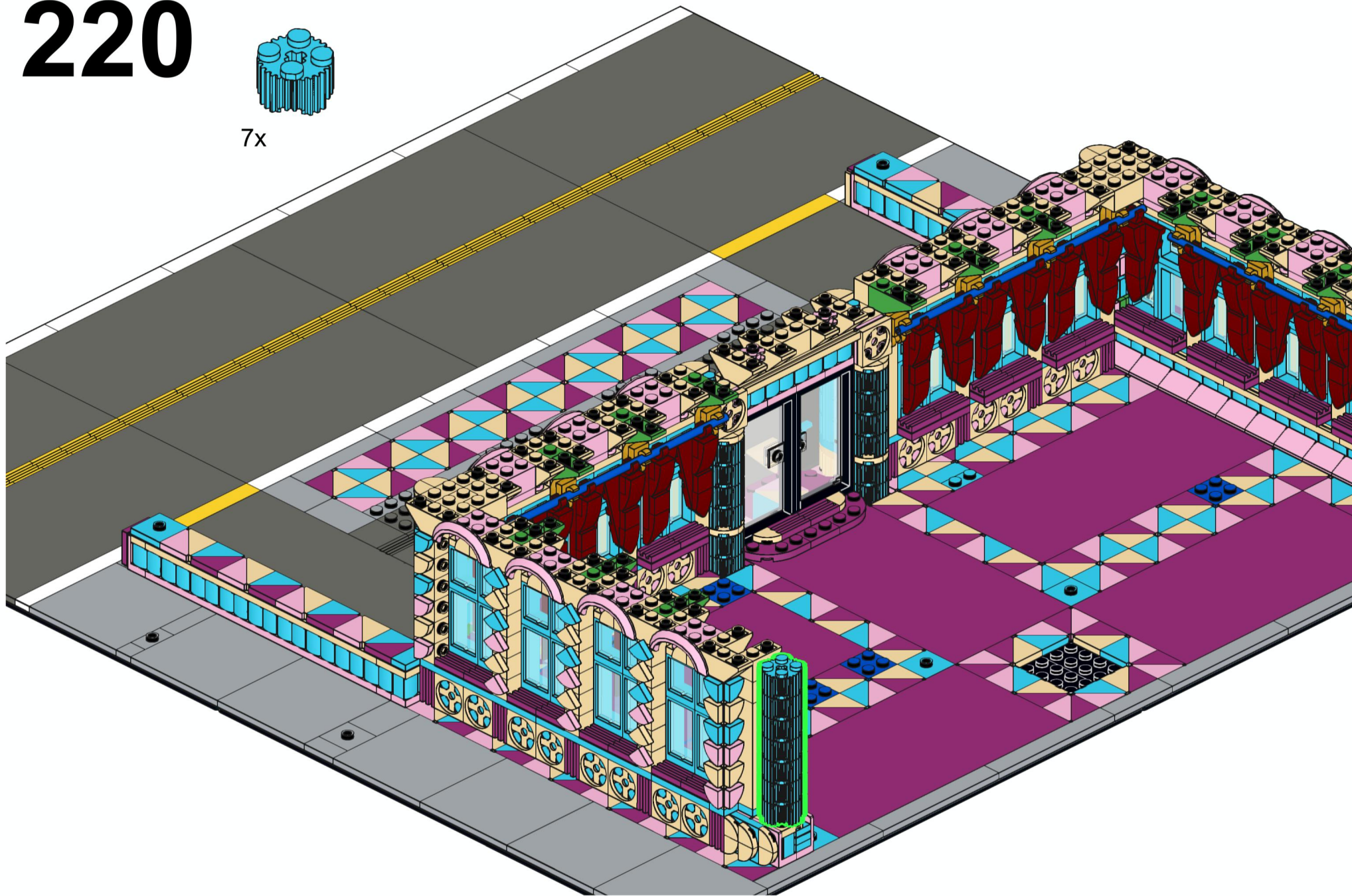

# 221

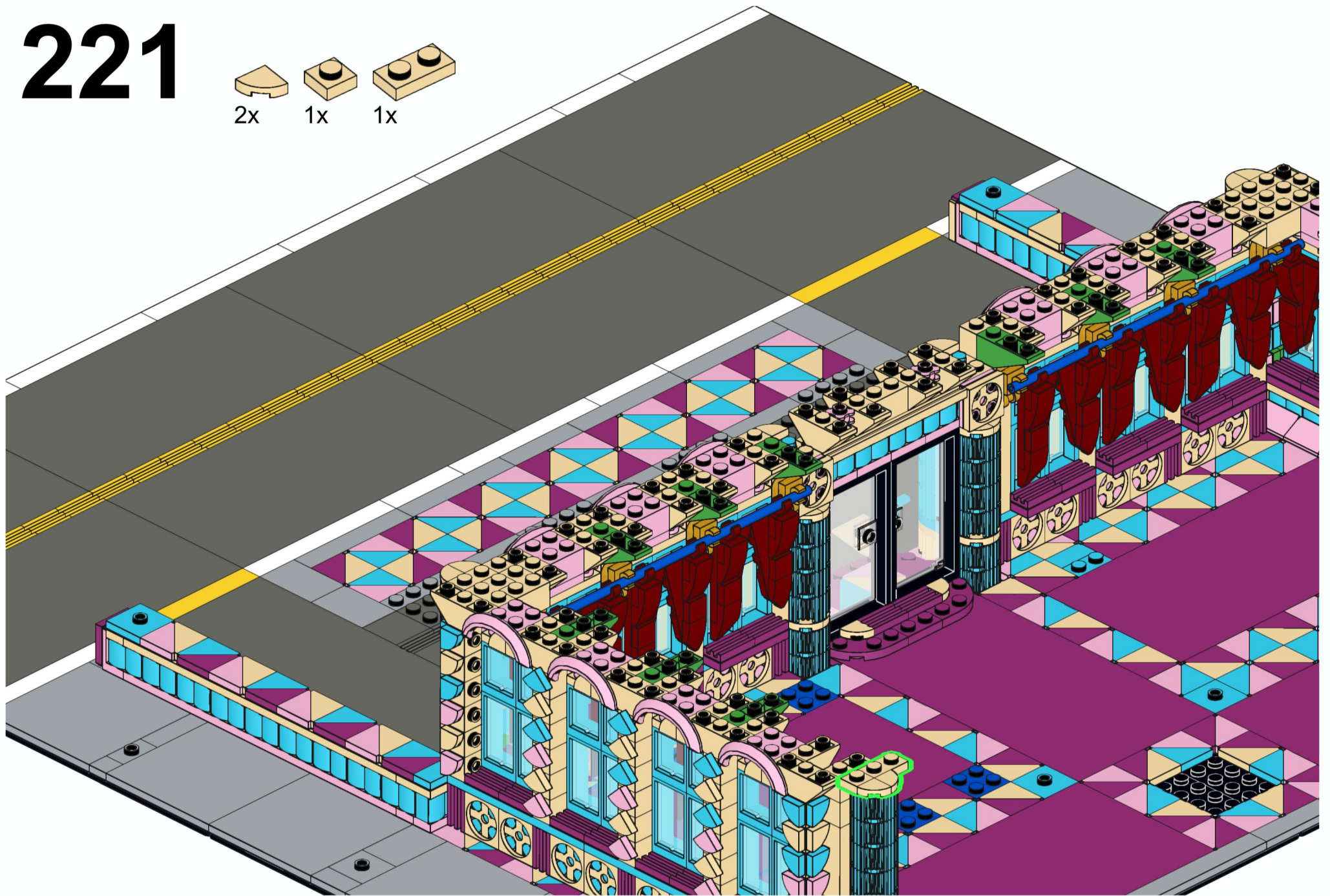
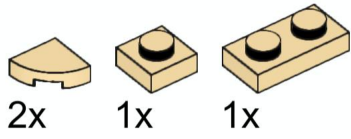

# 222



5x



5x

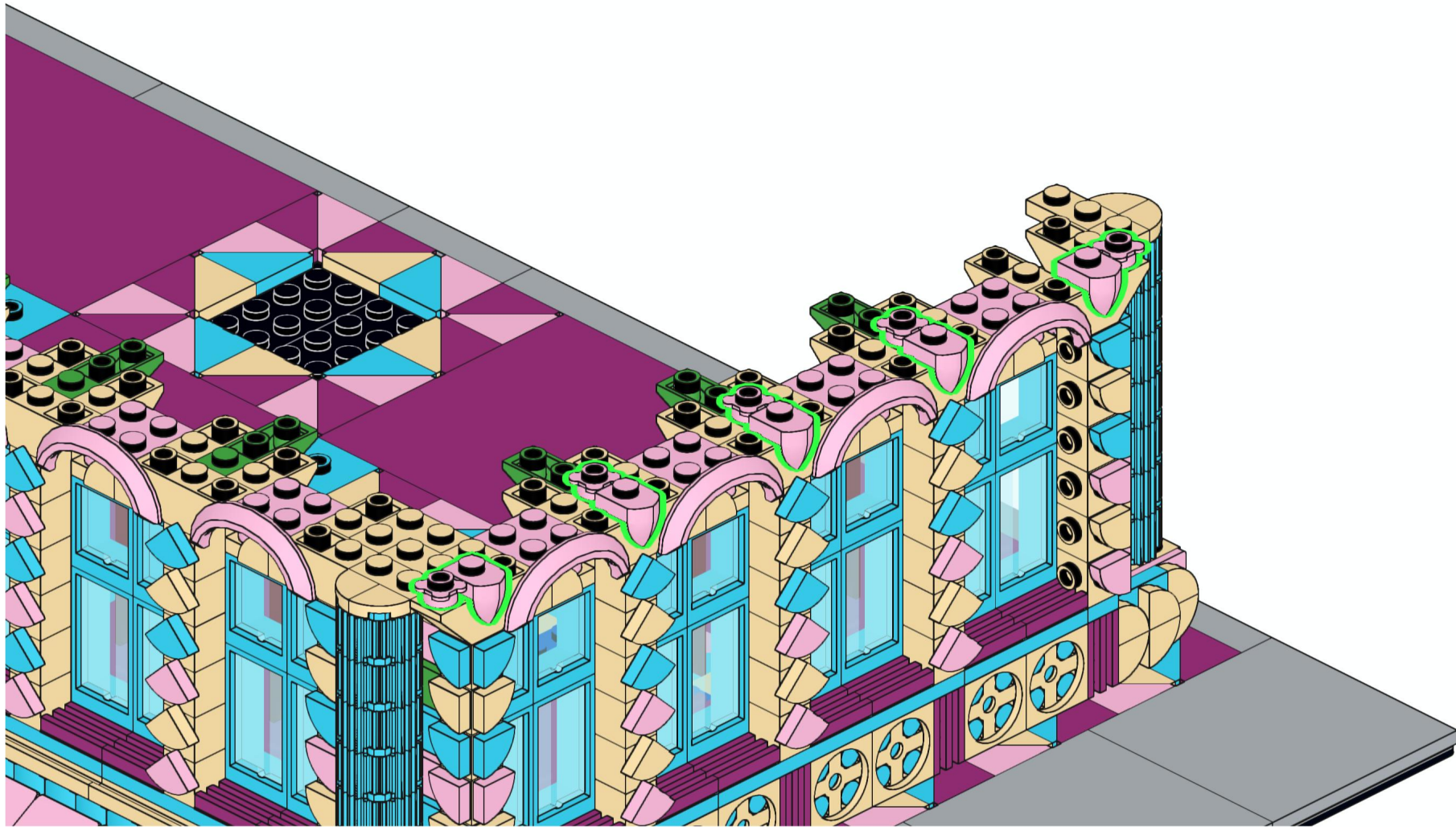

# 223



8x

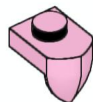

8x

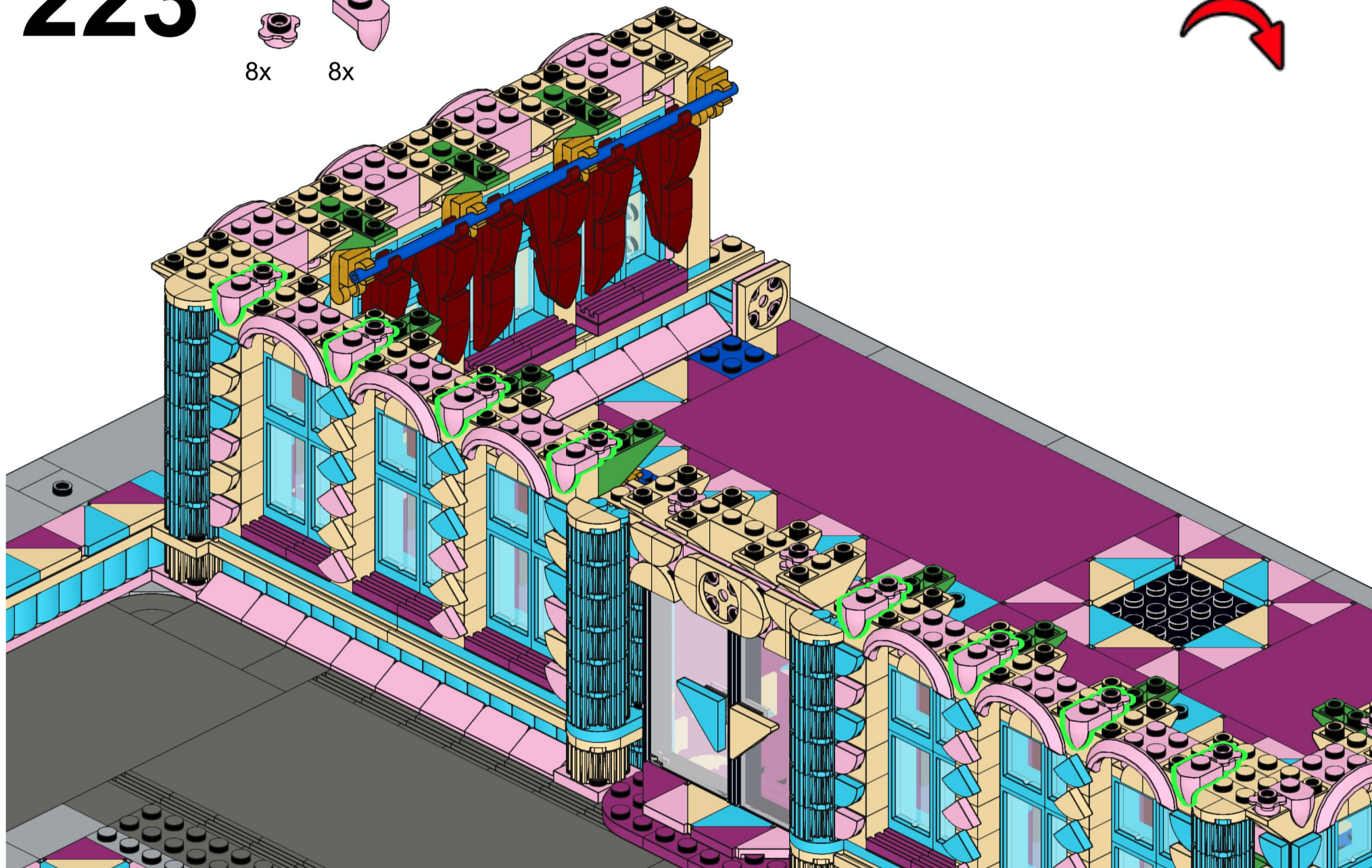

# 224



5x

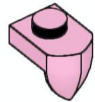

5x

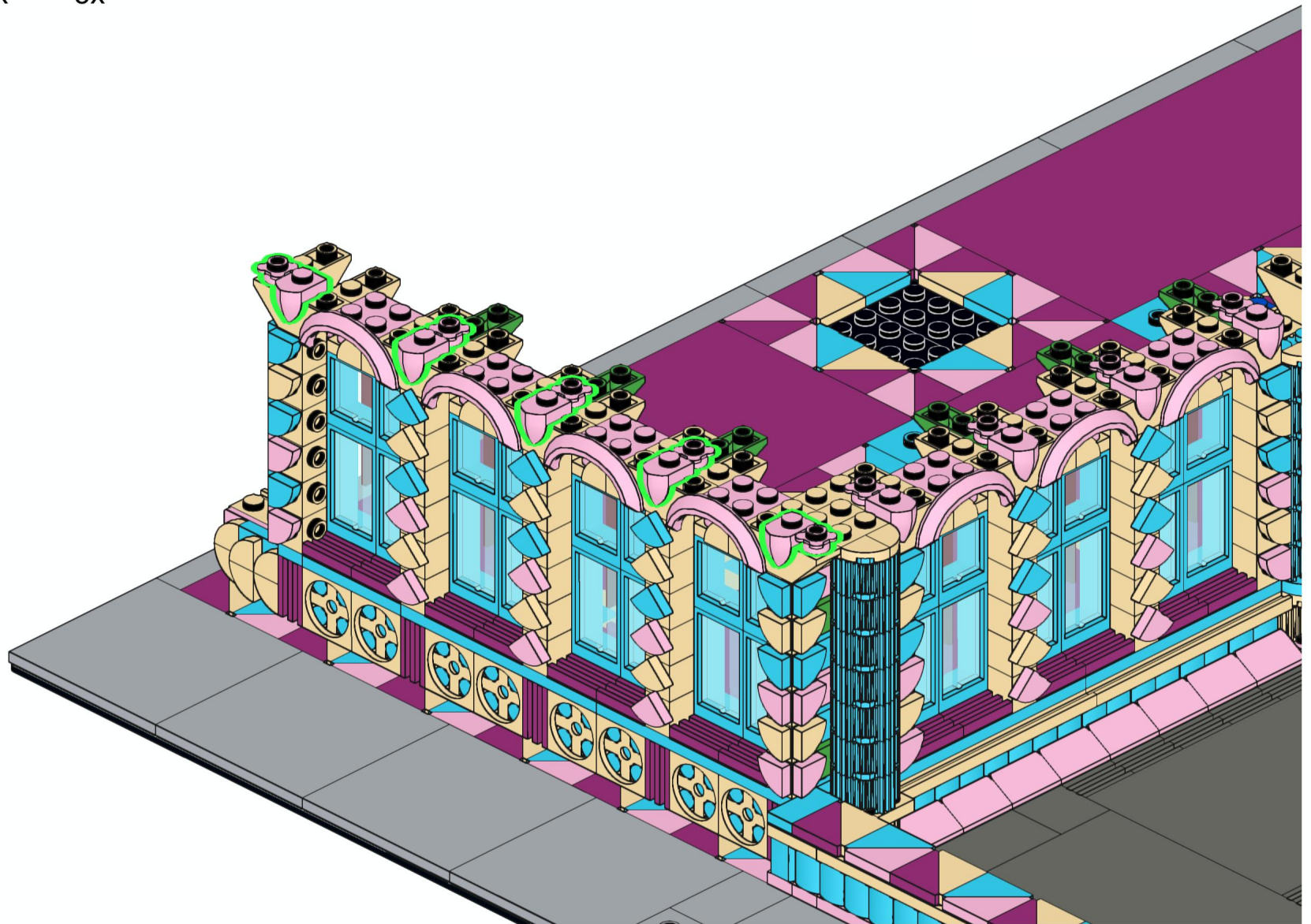

# 225

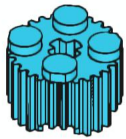

7x



# 226

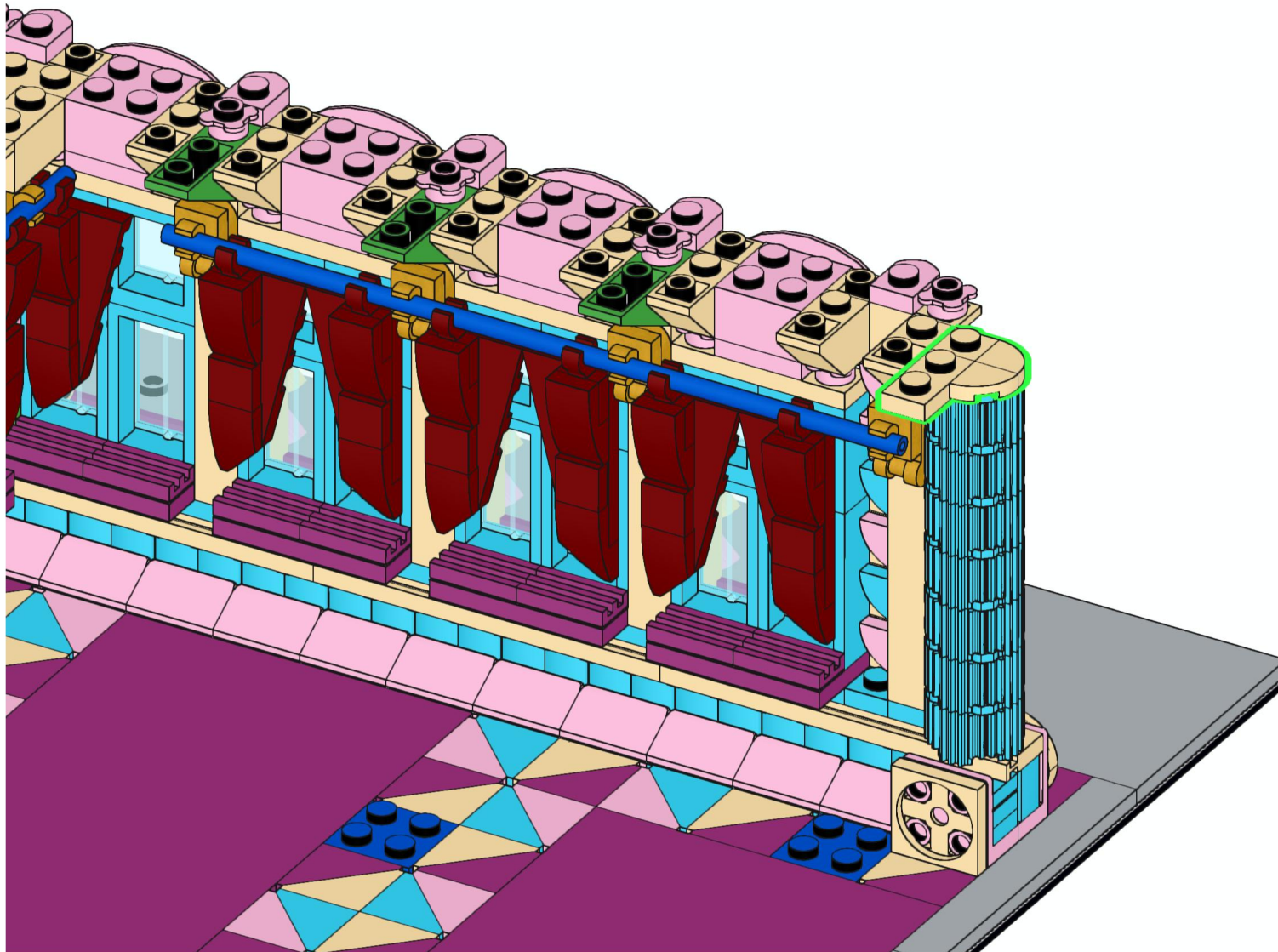
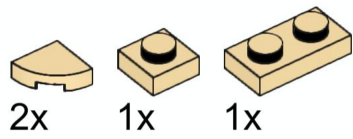

# 227

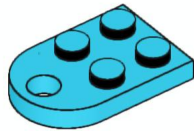

4x





# 228



4x



# 229

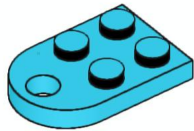

6x



# 230

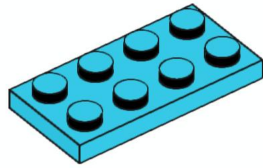

14x

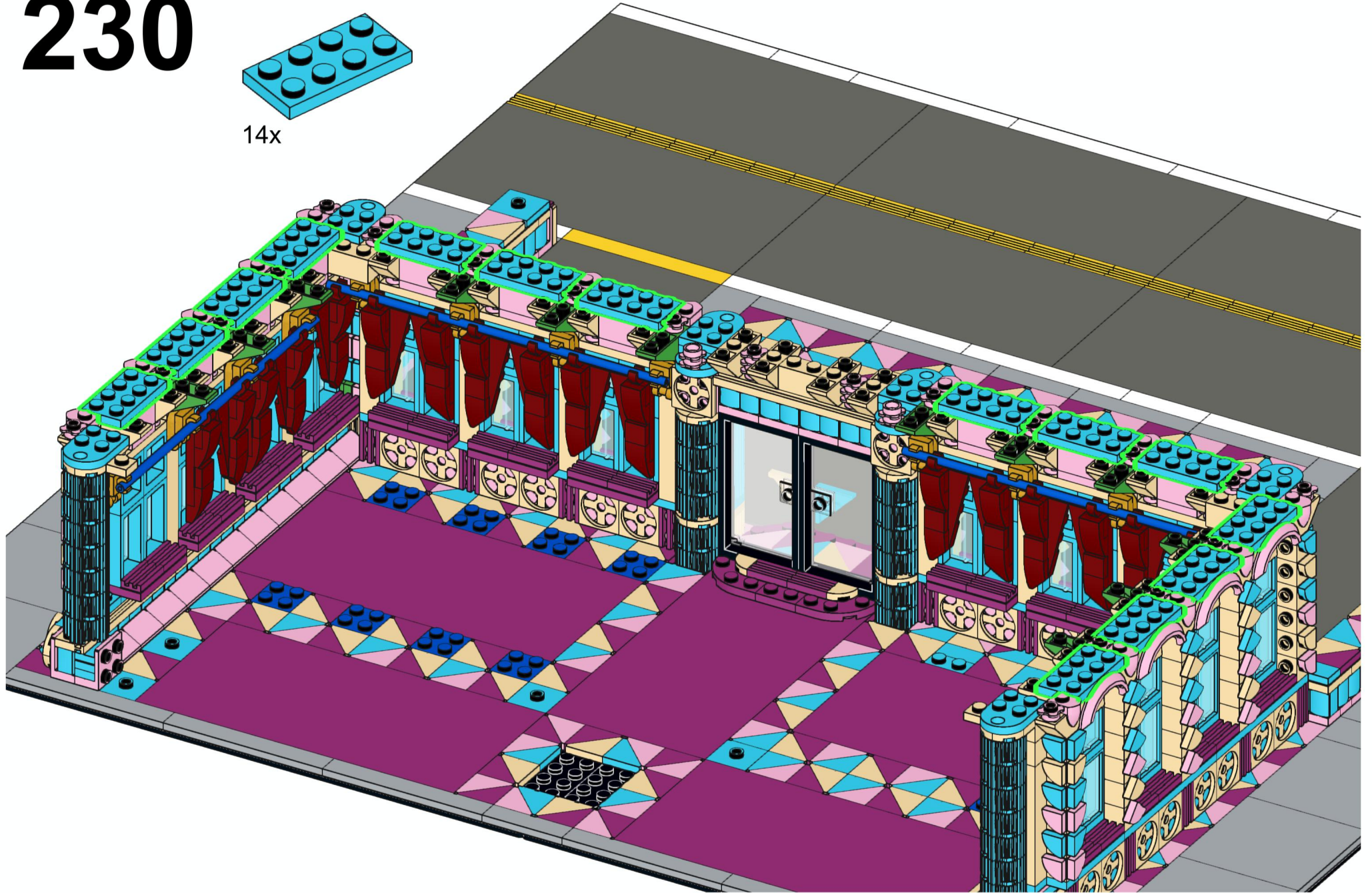

# 231



1x



1x

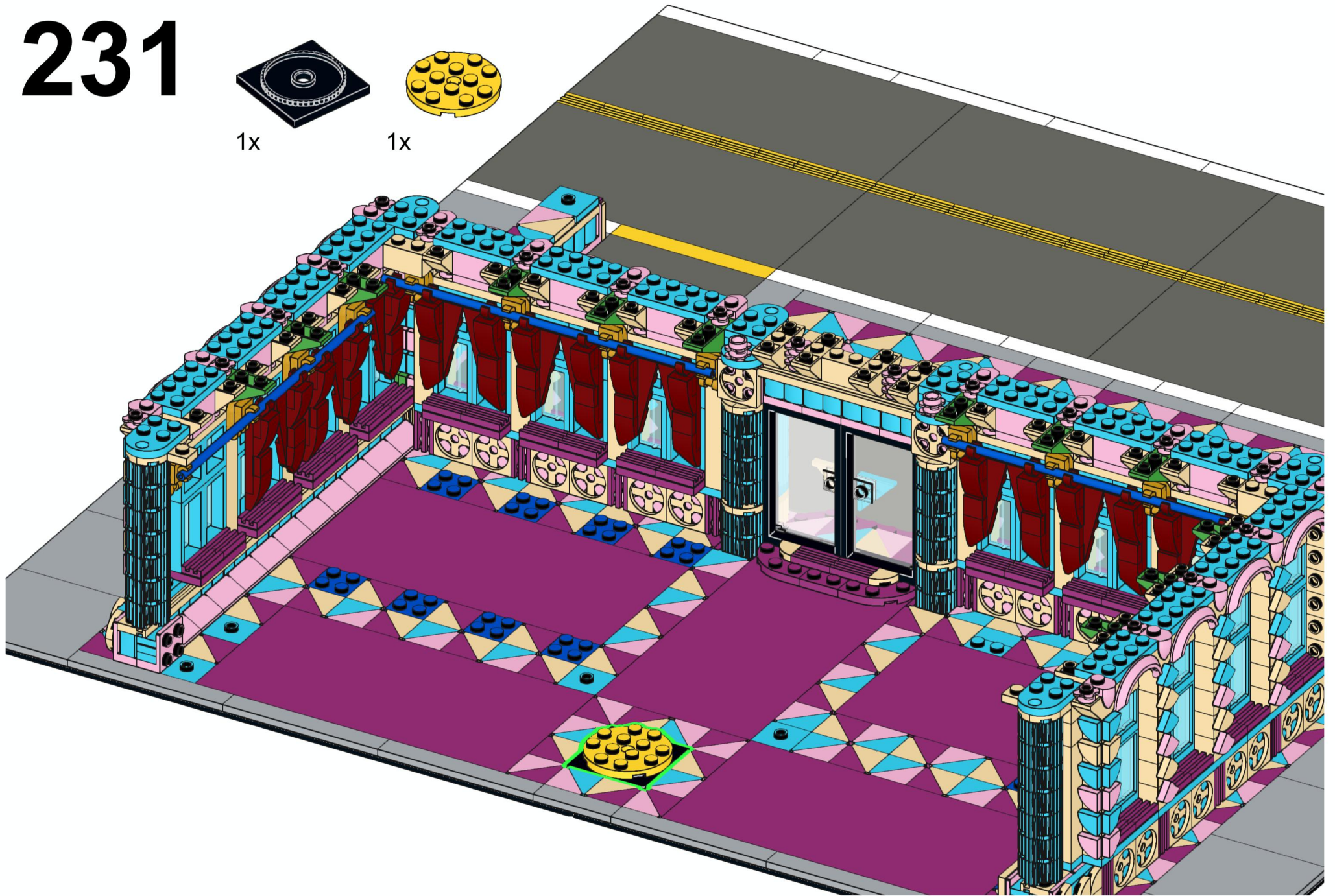

# 232



1x

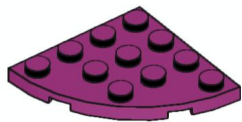

4x

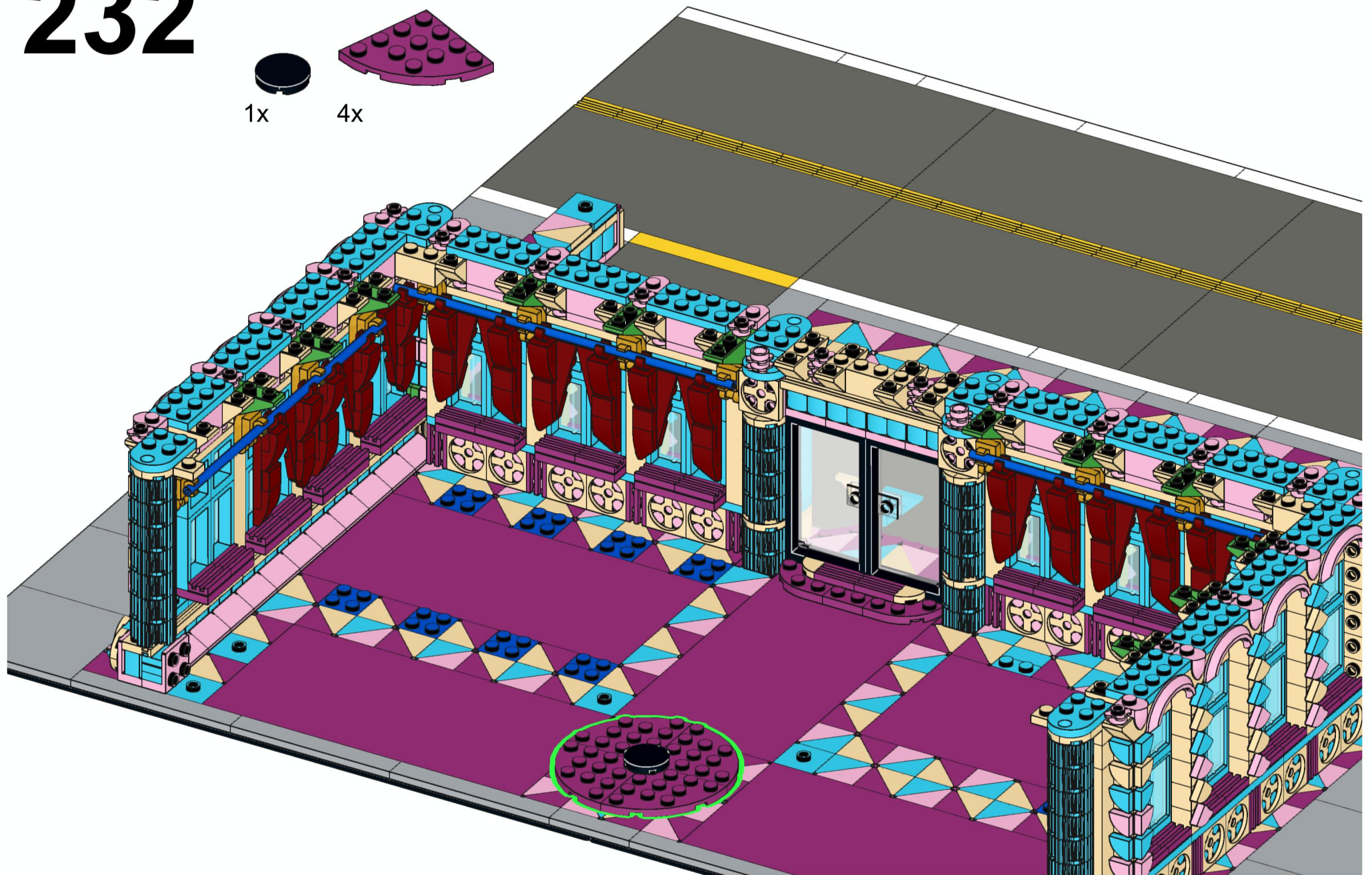

# 233

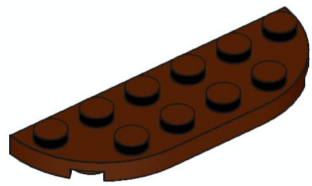

2x

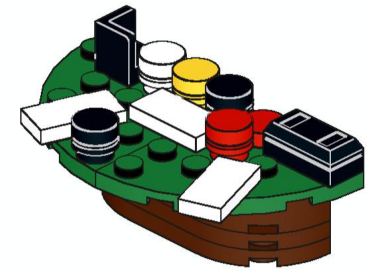
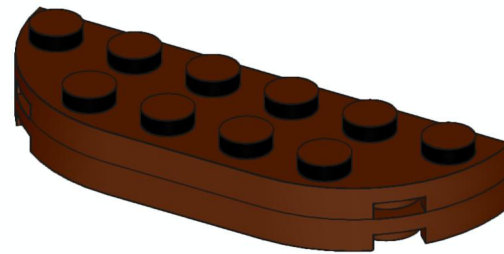

# 234

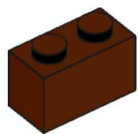

1x



2x

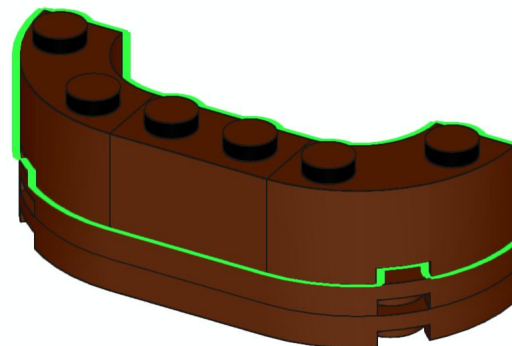

# 235

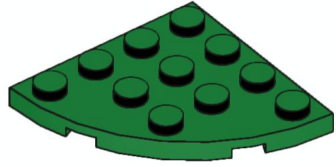

2x

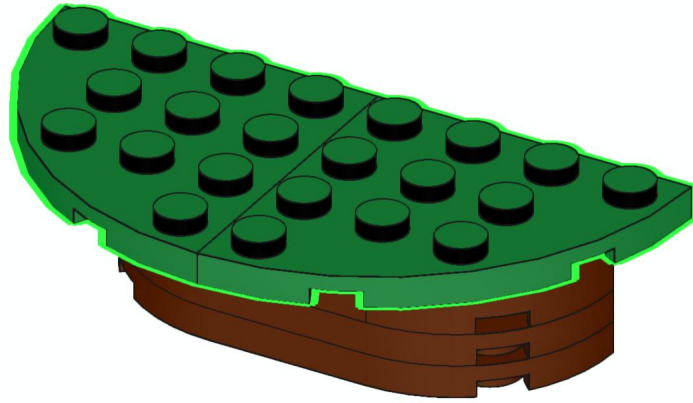

# 236

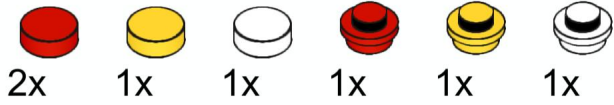

2x

1x

1x

1x

1x

1x

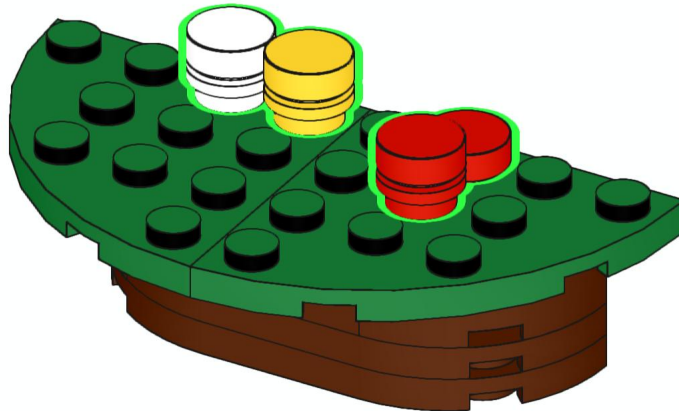

# 237

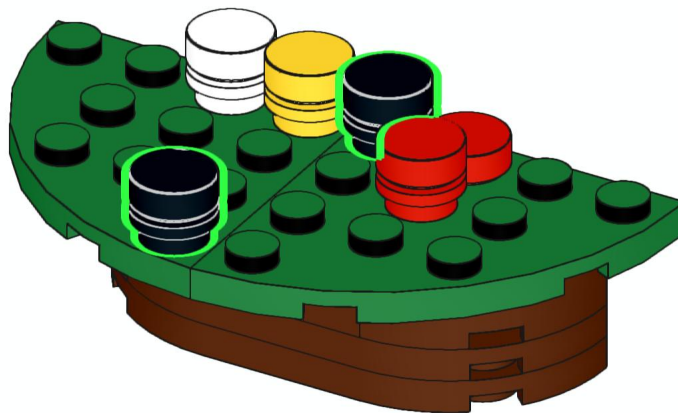

# 238

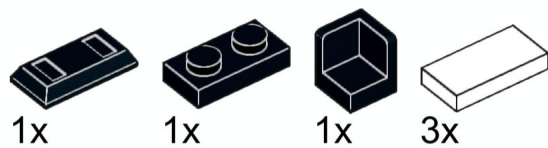



239



# 240

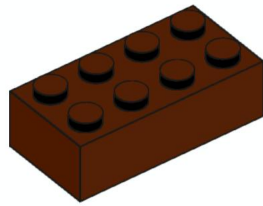

1x

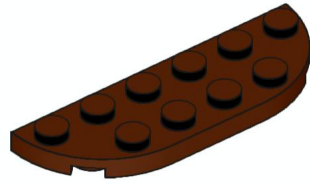

2x

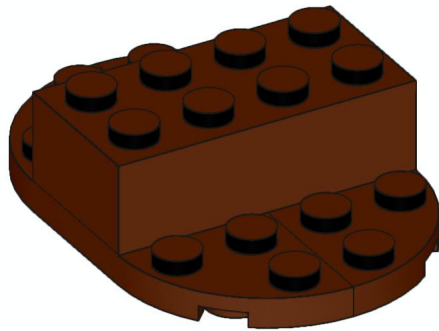

# 241



4x

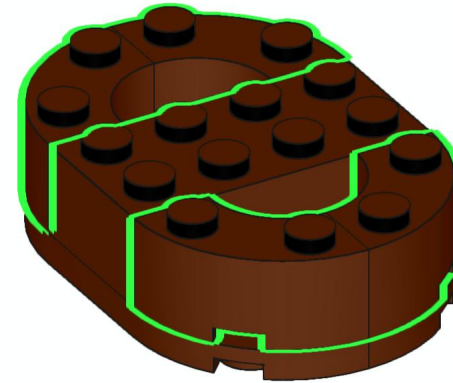

# 242

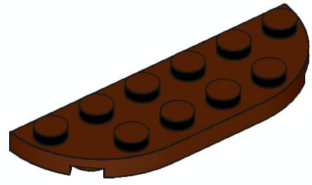

2x

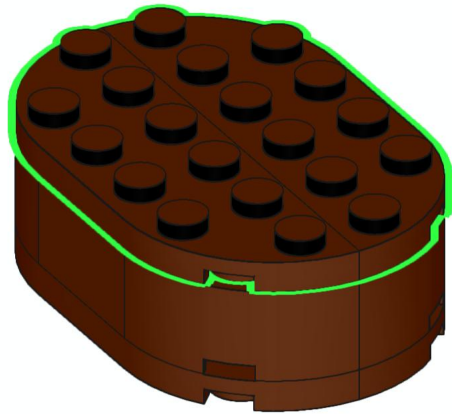

# 243

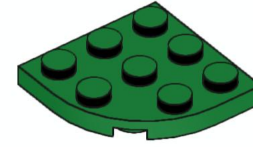

4x

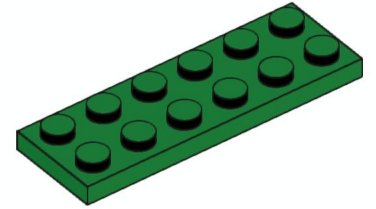

1x

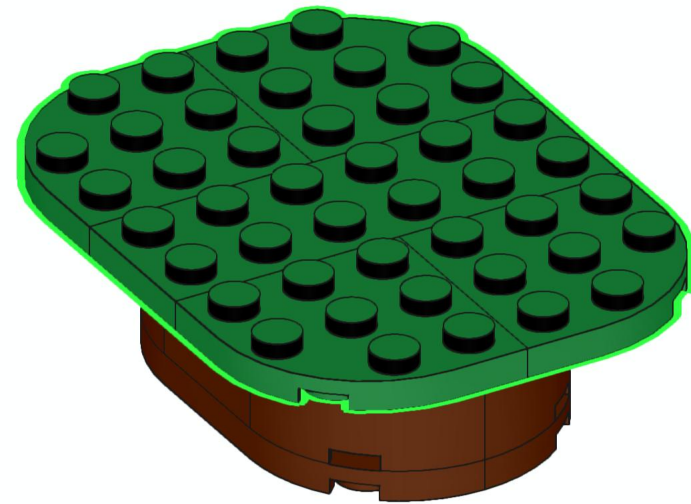

# 244

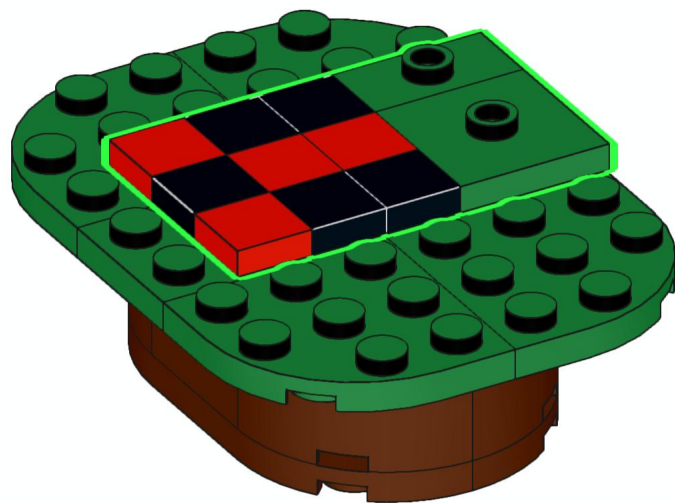
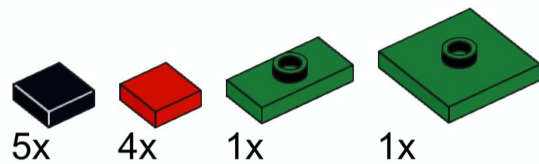

# 245

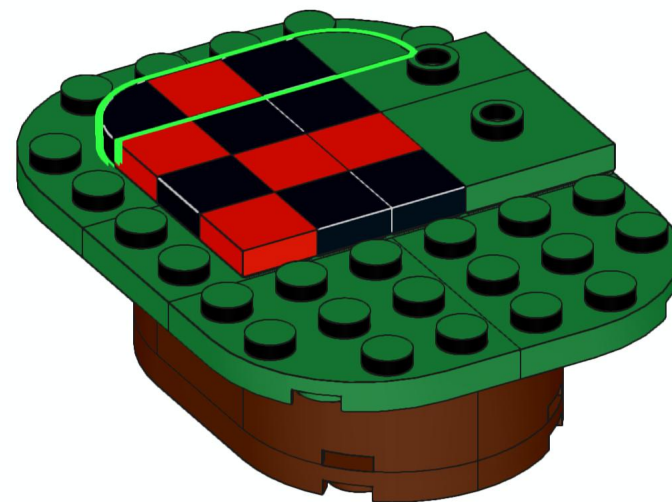
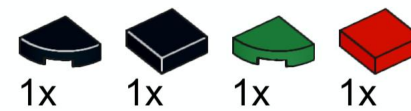

# 246

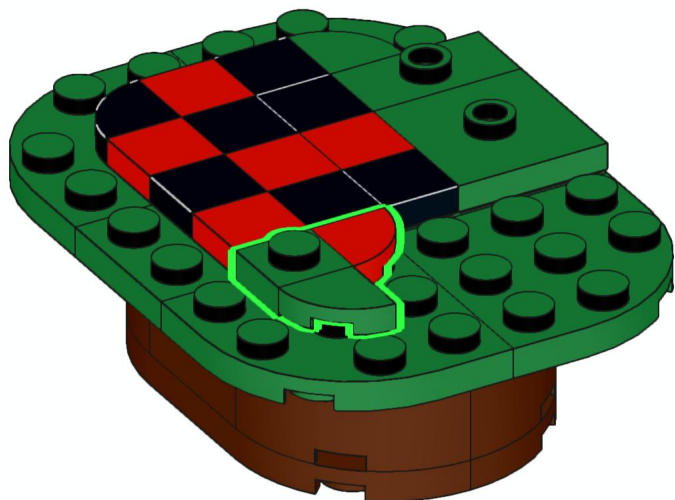
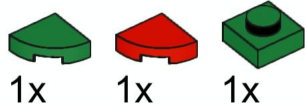

# 247

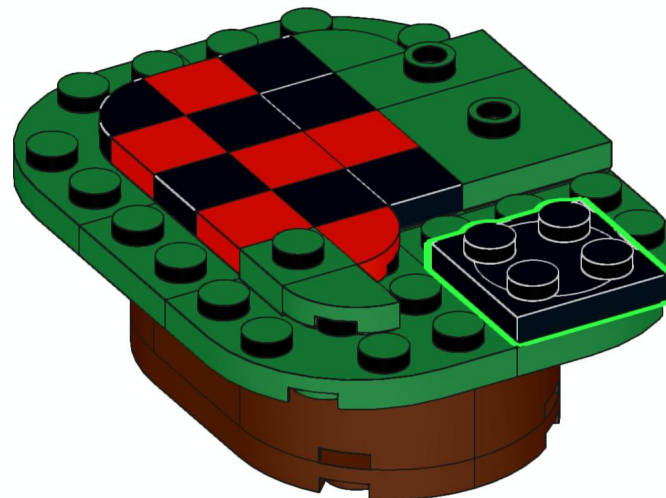
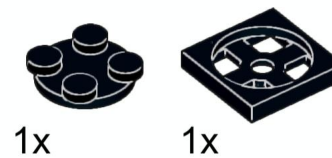

# 248

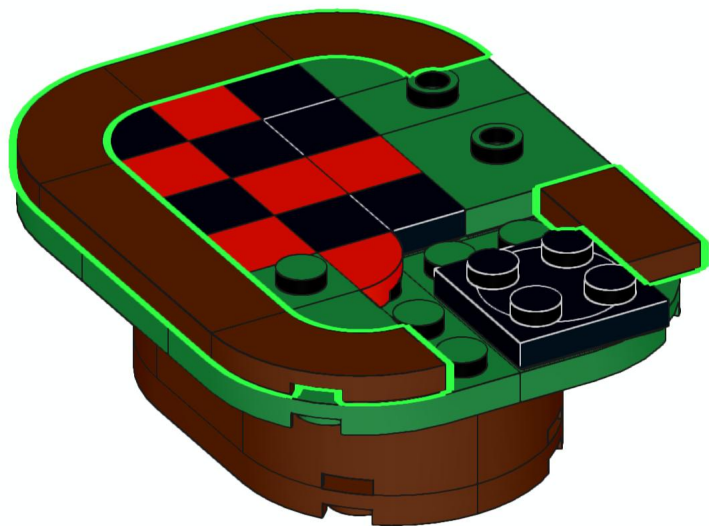
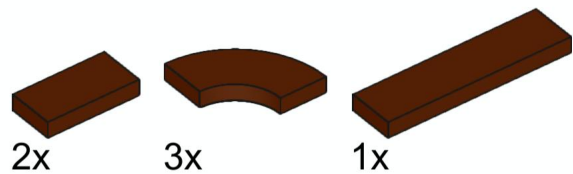

# 249

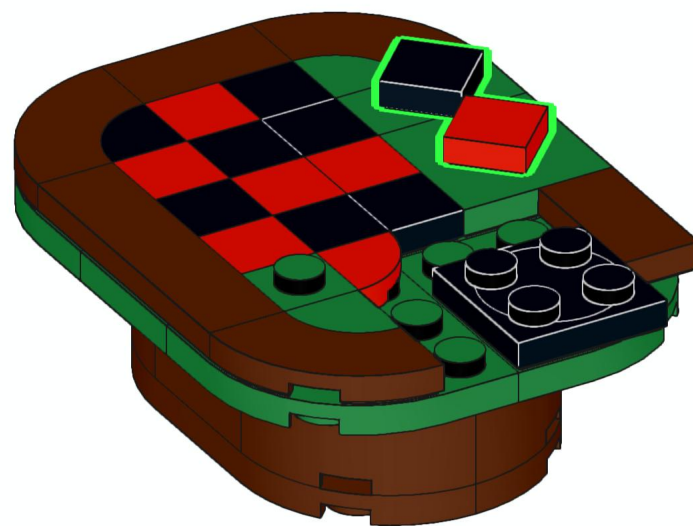
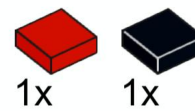

# 250

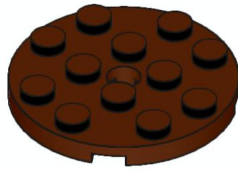

1x

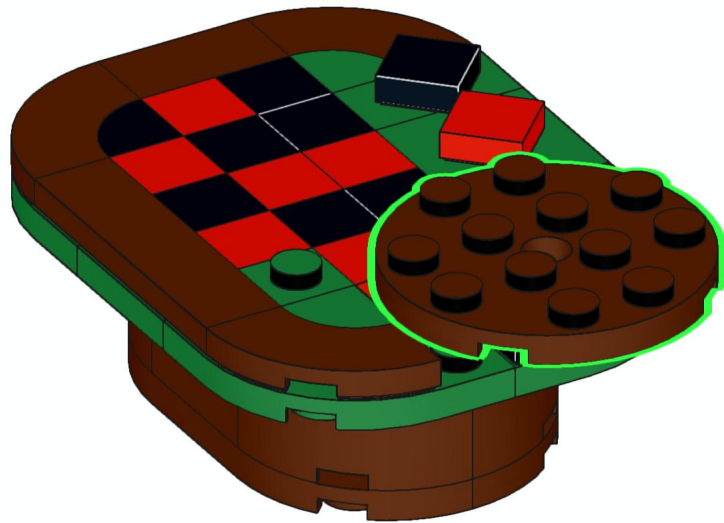

# 251

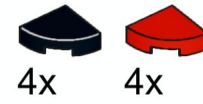

4x

4x

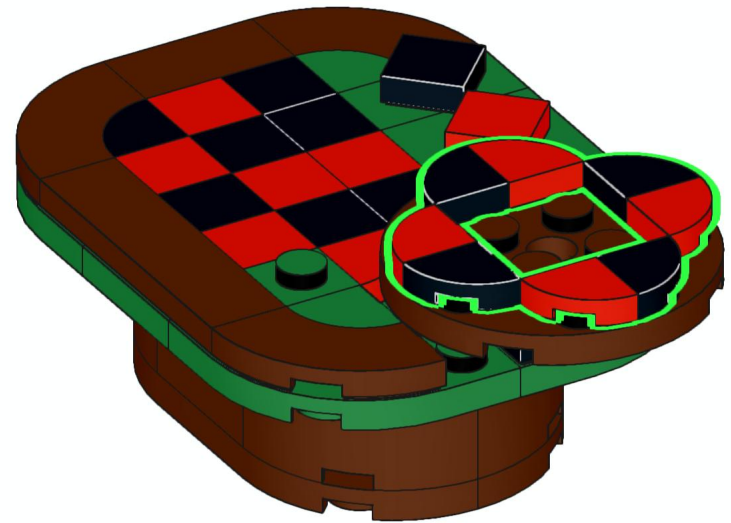

# 252

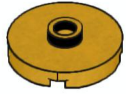

1x

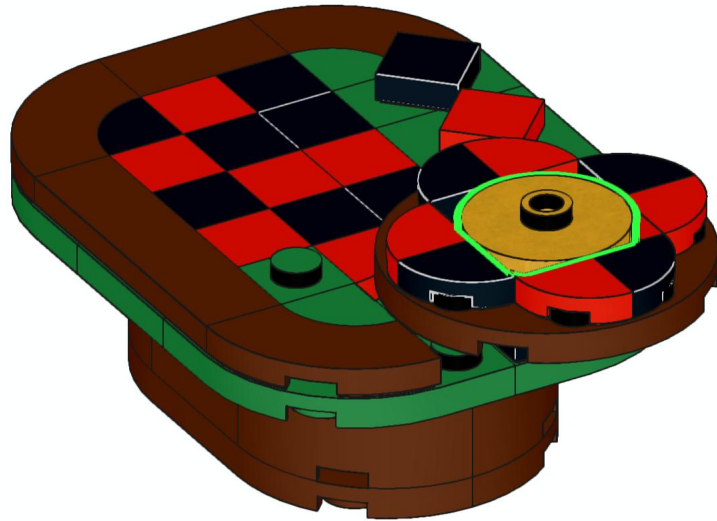

# 253



1x



1x





# 254

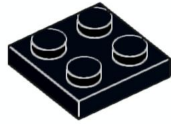

1x

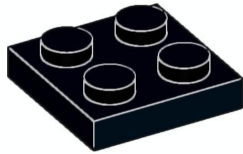
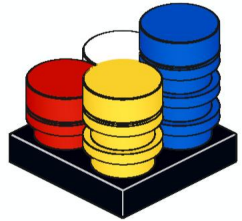

# 256



1x



1x



1x



1x

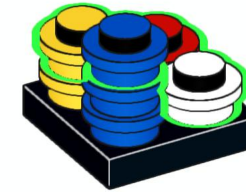

# 255



2x



1x

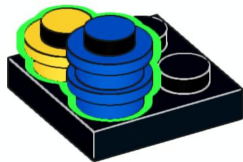

# 257



1x



1x



1x



1x



258

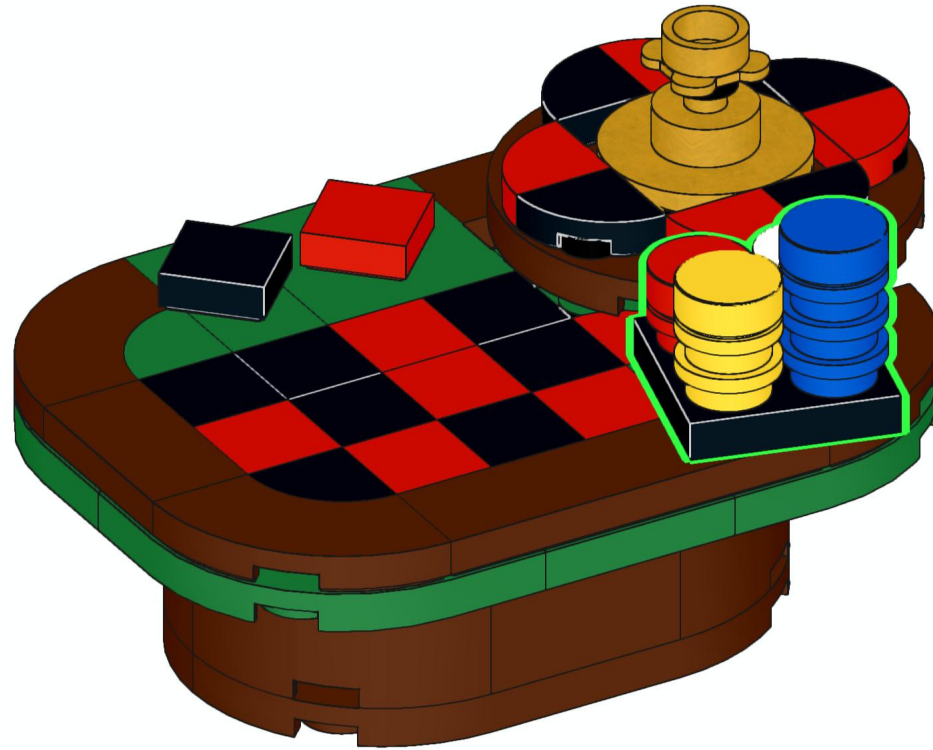

# 259



# 260

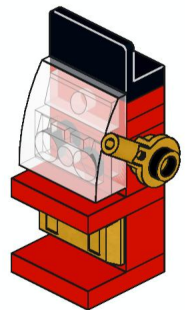
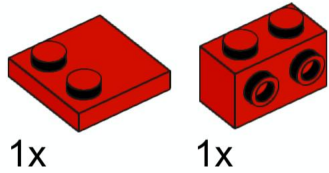

**X2**

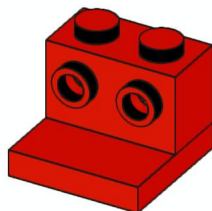

# 261

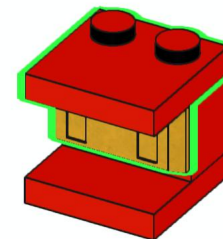
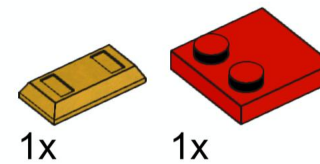

# 262

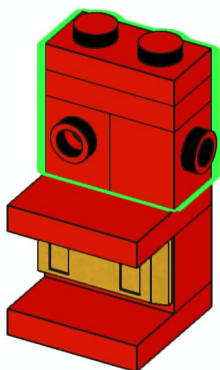
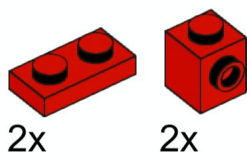

# 263

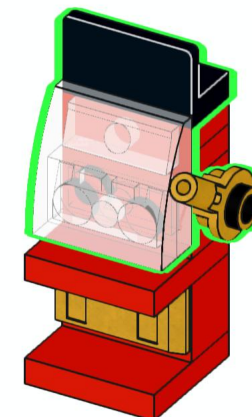
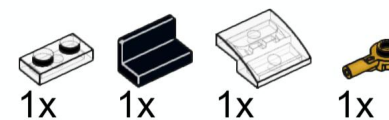

# 264

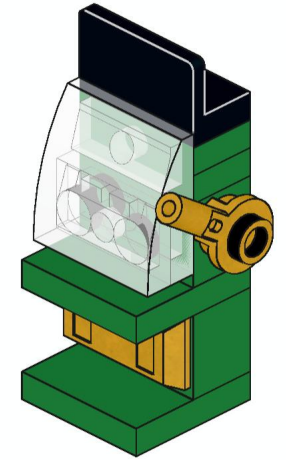

**X3**

# 265

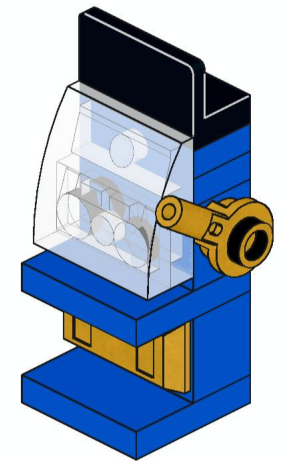

**X3**

266

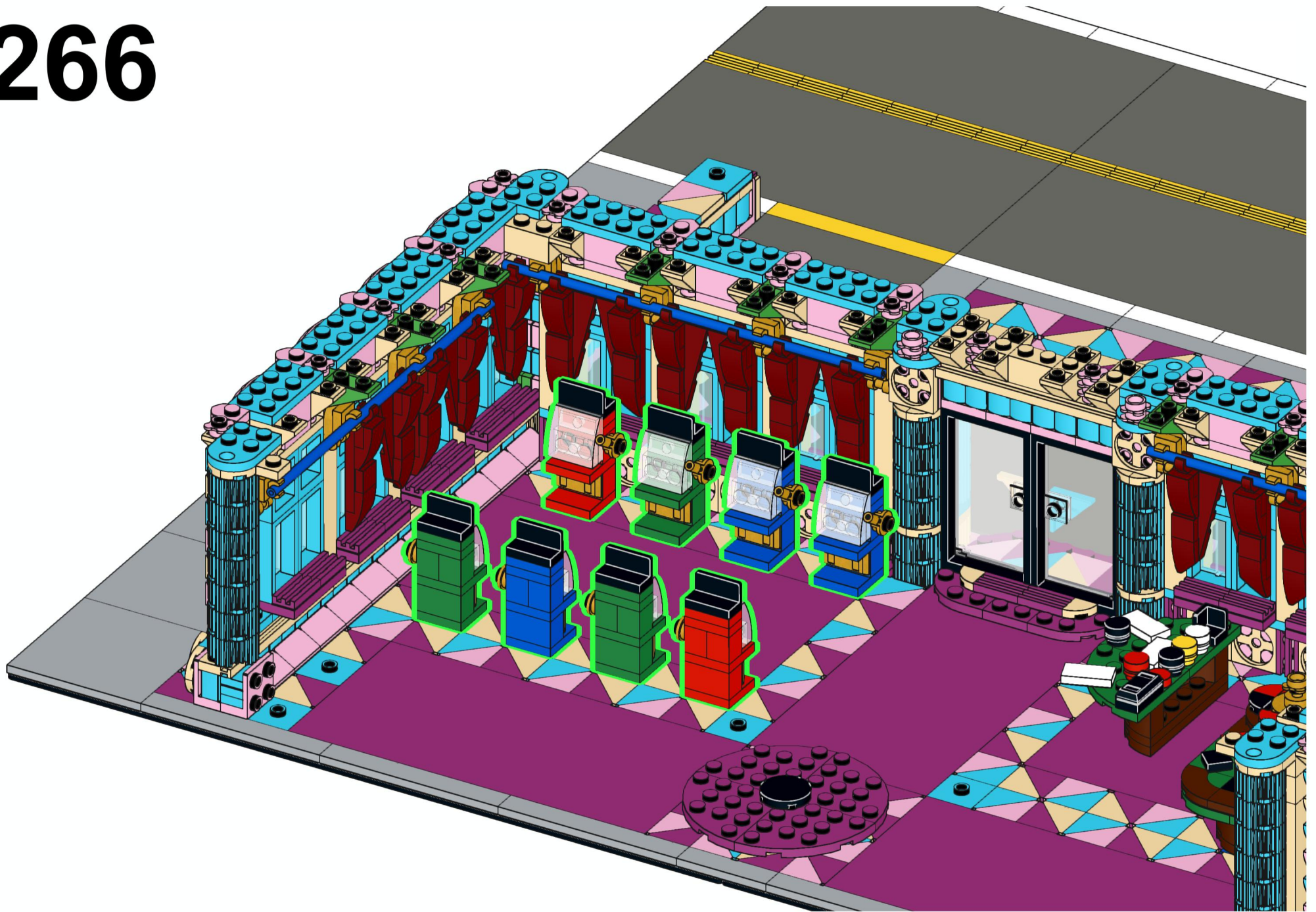

# 267

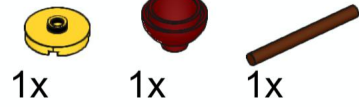

X2

# 269

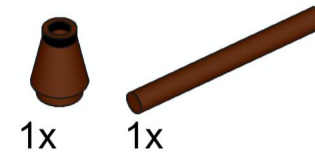

# 268



# 270

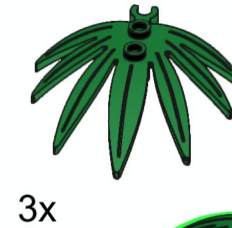

271





# 272

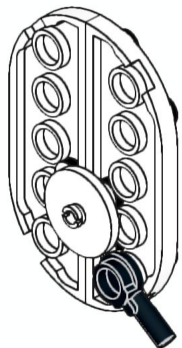
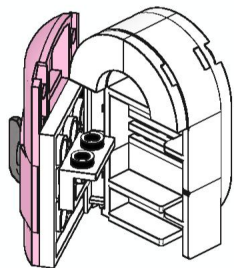
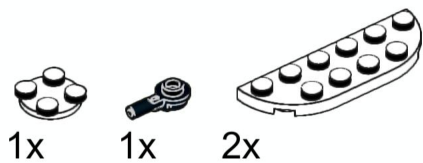

# 274

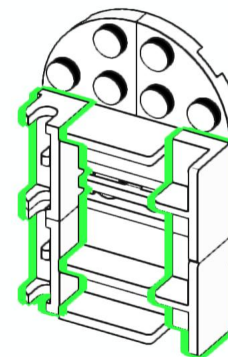
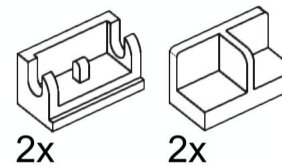

# 273

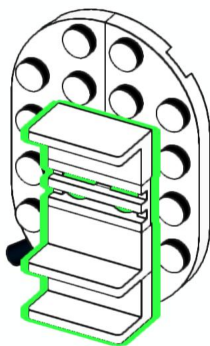
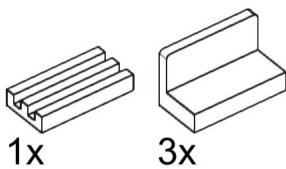

# 275

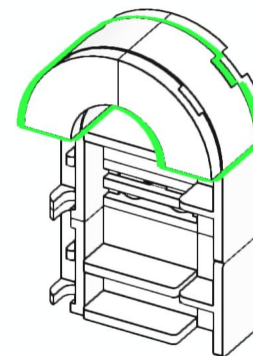
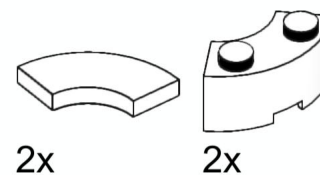

# 276

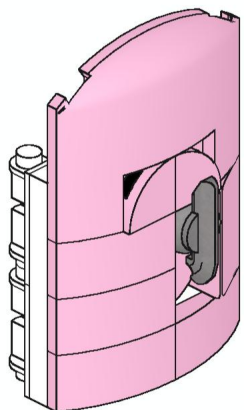
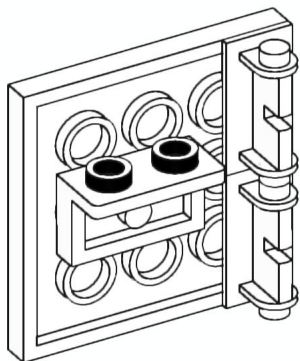
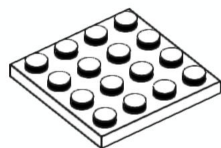
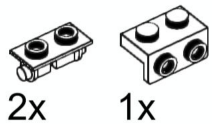

# 277

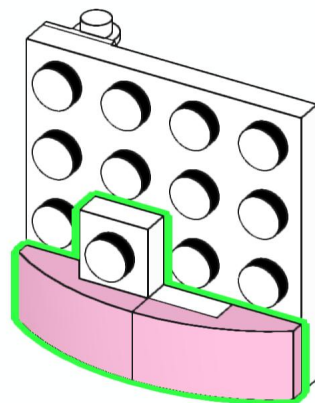
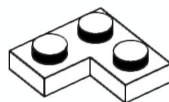
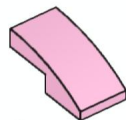

# 278

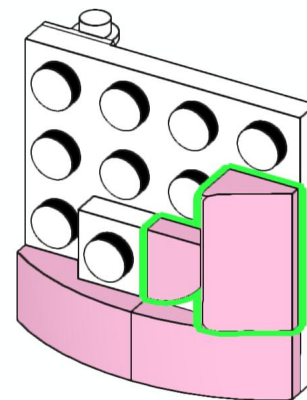
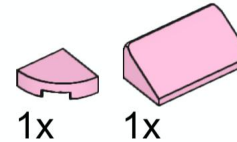

# 279

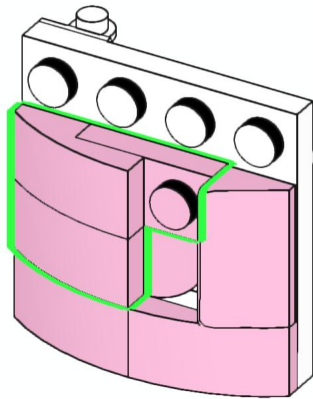
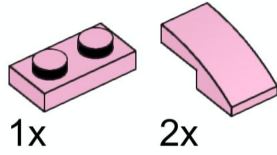

# 280

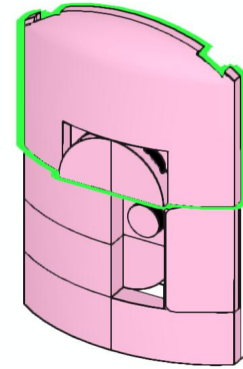
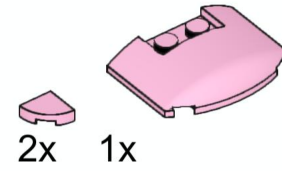

# 281

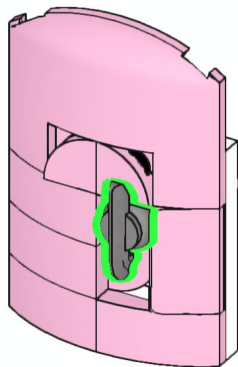
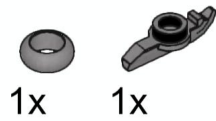

# 282

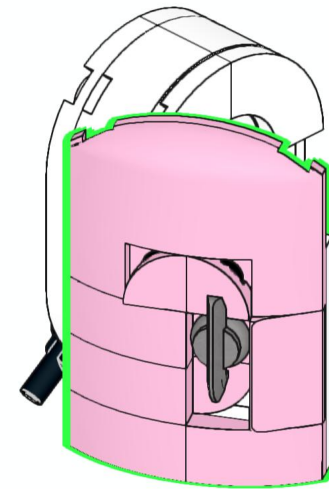

283



# 284

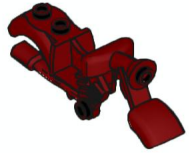

1x



1x

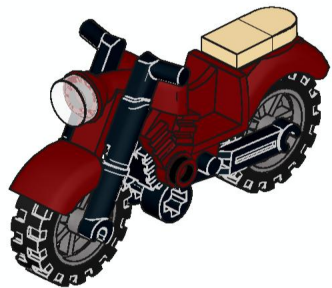

# 285



2x



2x

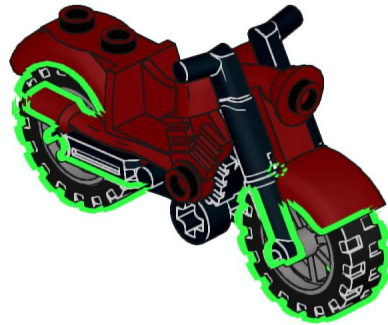

# 286

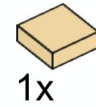

1x

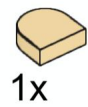

1x



1x

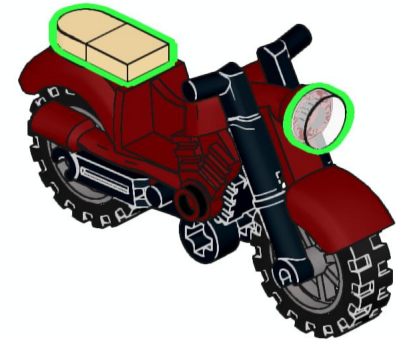

287



# 288

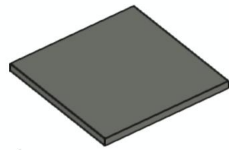

1x

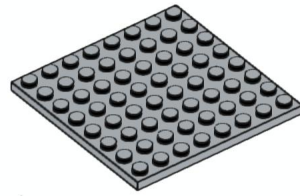

1x

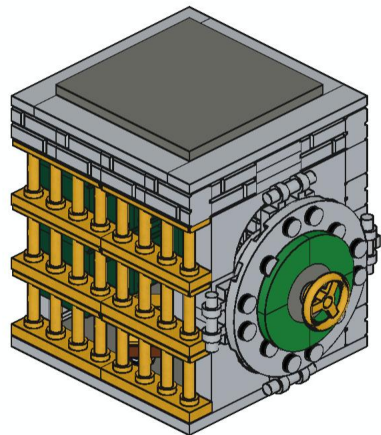
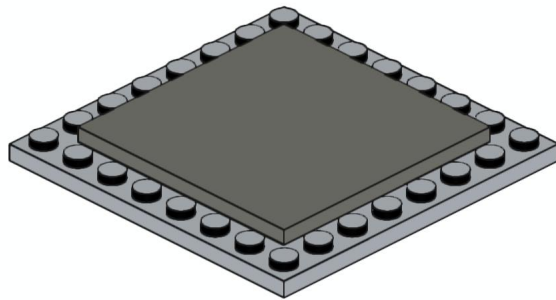

# 289

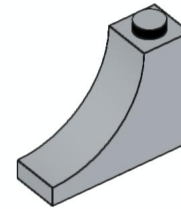

2x

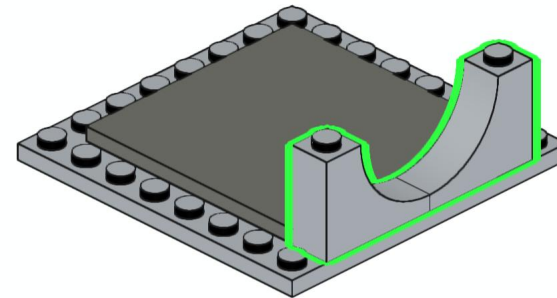

# 290

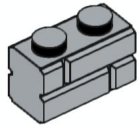

7x

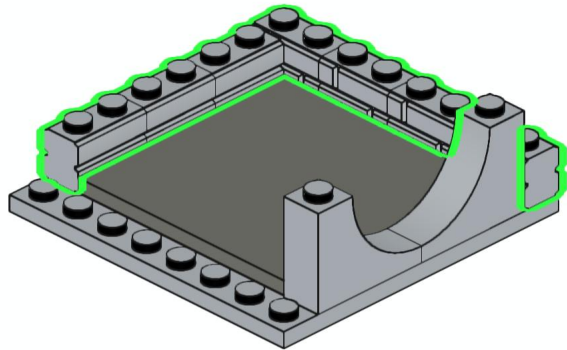

# 291

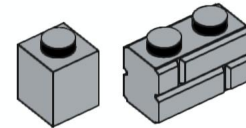

2x

3x

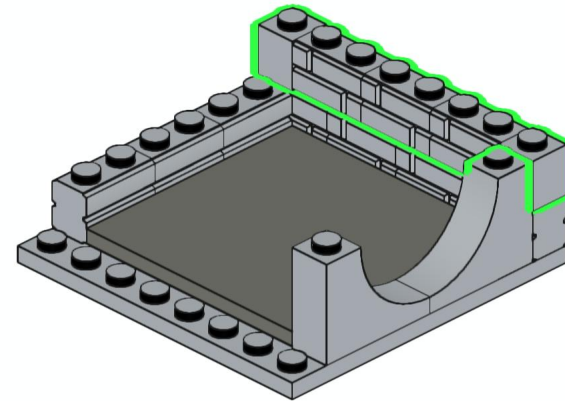



# 292

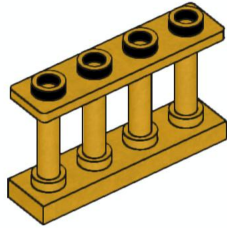

6x

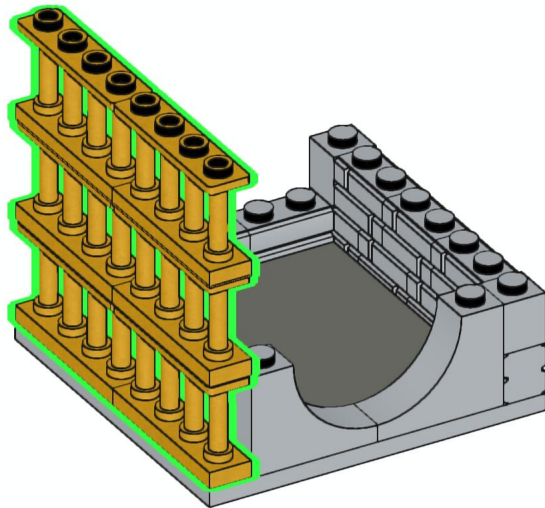

# 293

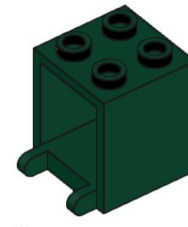

9x

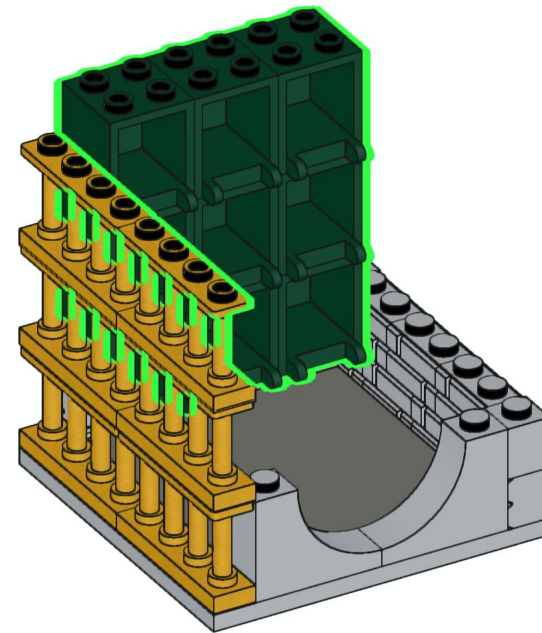

# 294

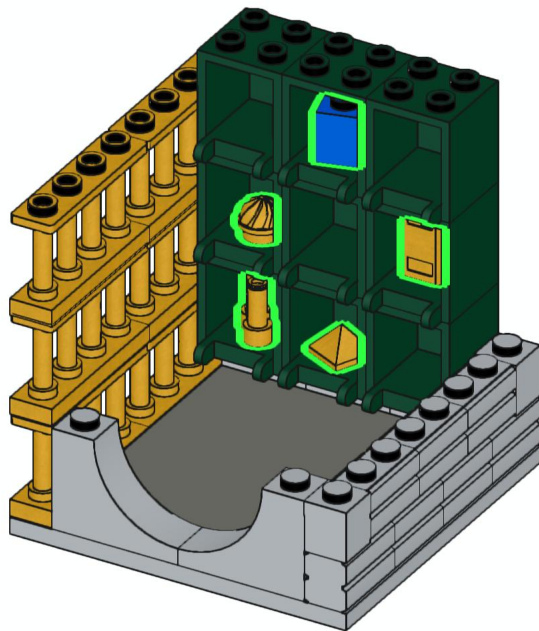
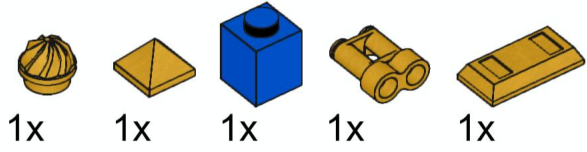

# 295

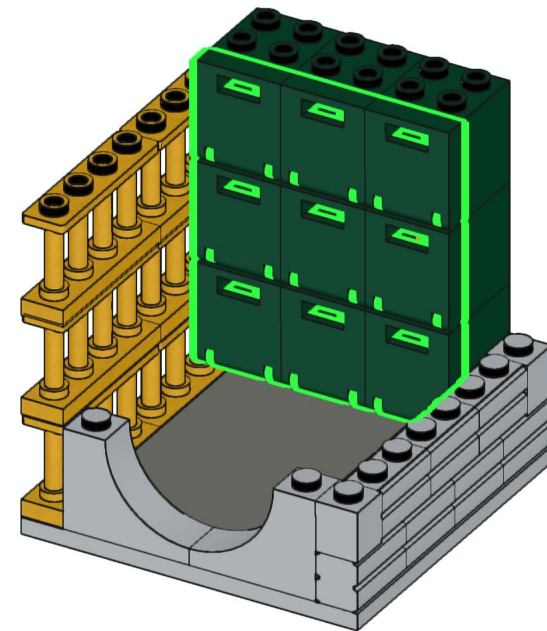

# 296

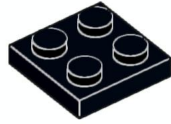

1x

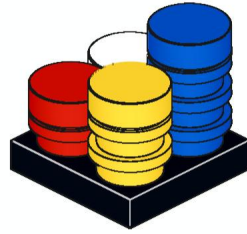

# 298



1x



1x



1x



1x



# 297



2x



1x



# 299



1x



1x



1x



1x



# 300



1x

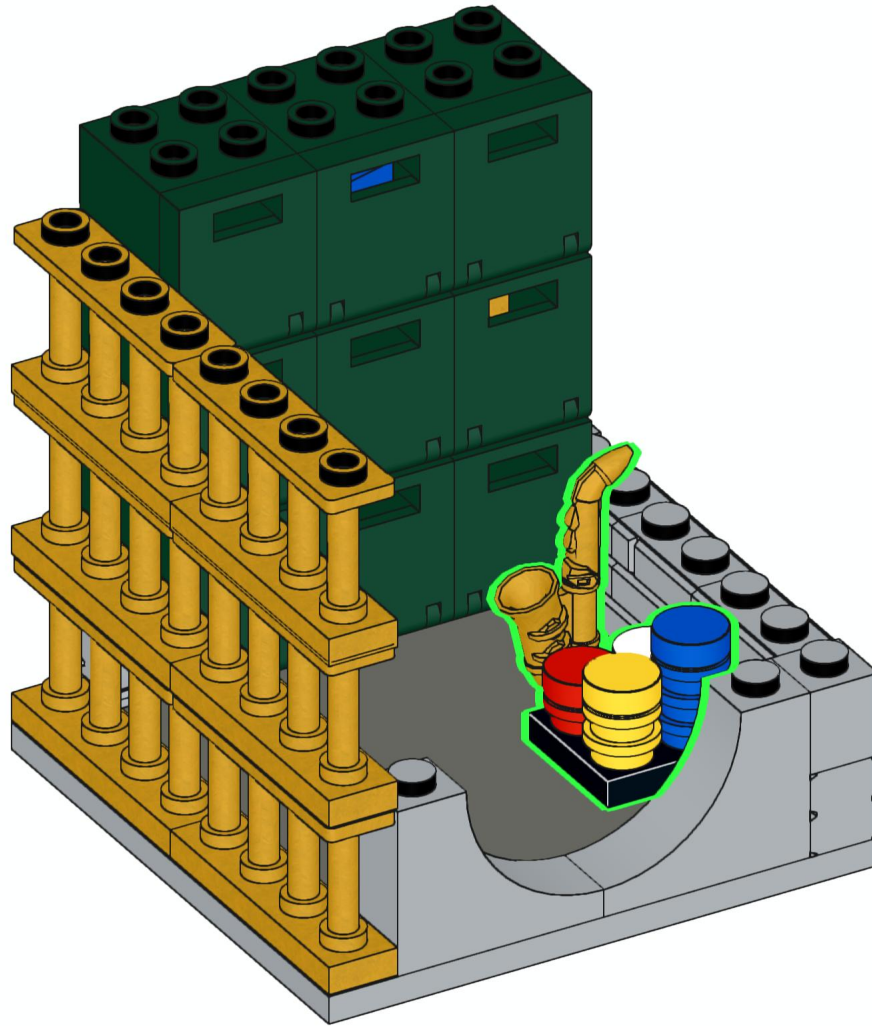

# 301



4x

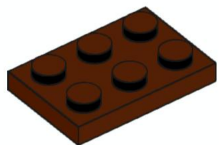

1x

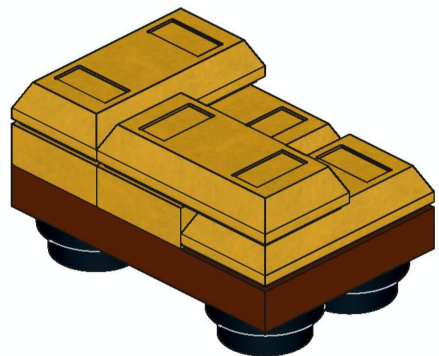

# 302



2x

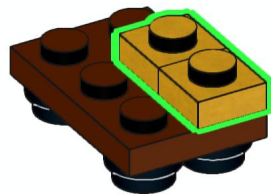

# 303



4x

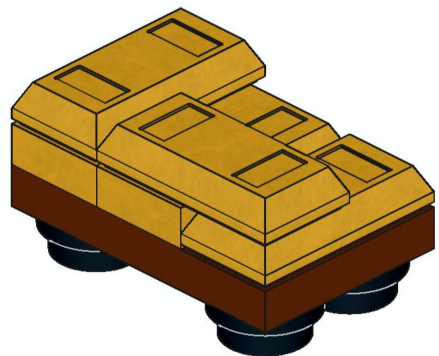
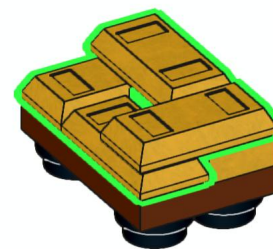

# 304

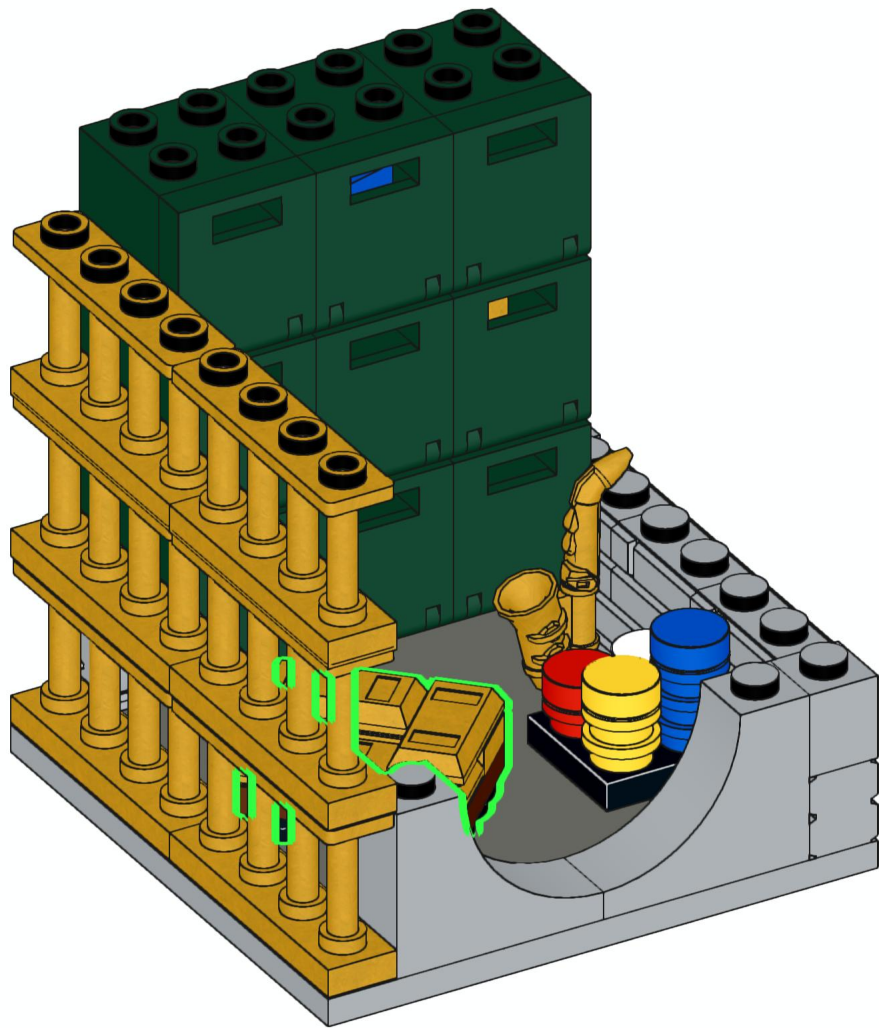

# 305

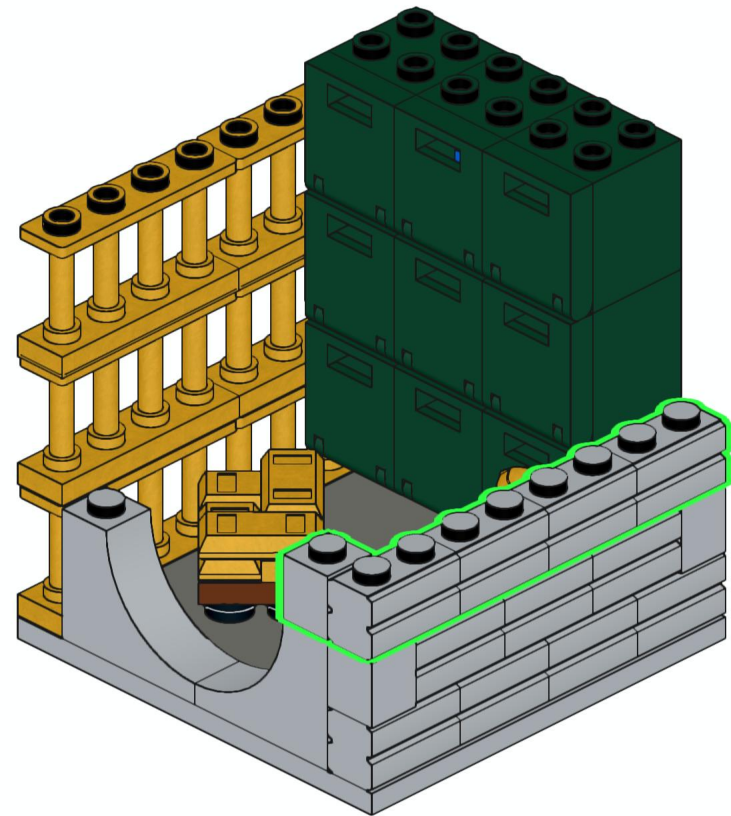
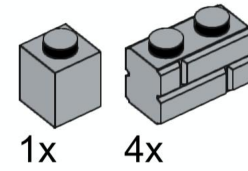

# 306

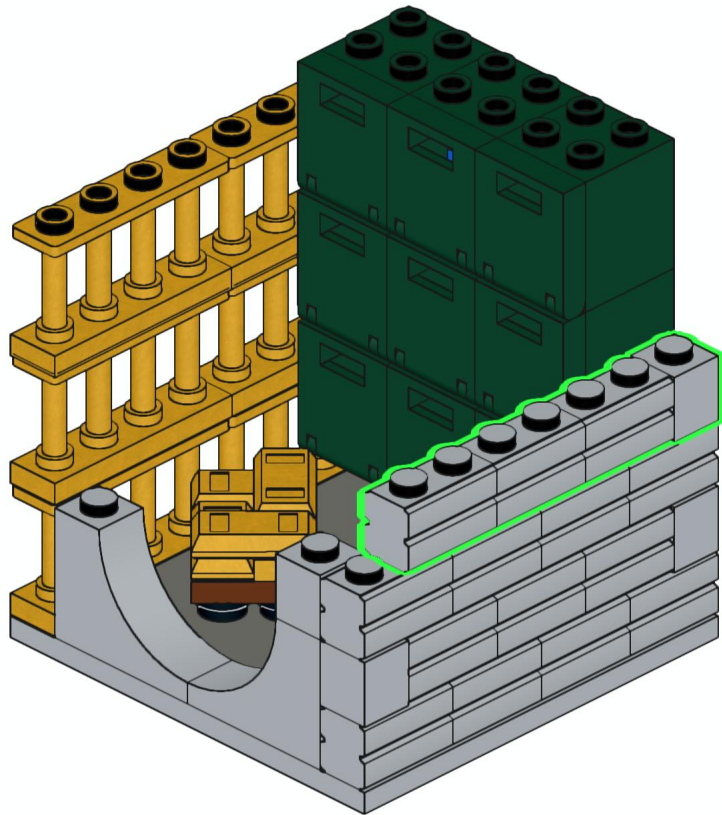
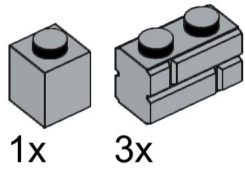

# 307

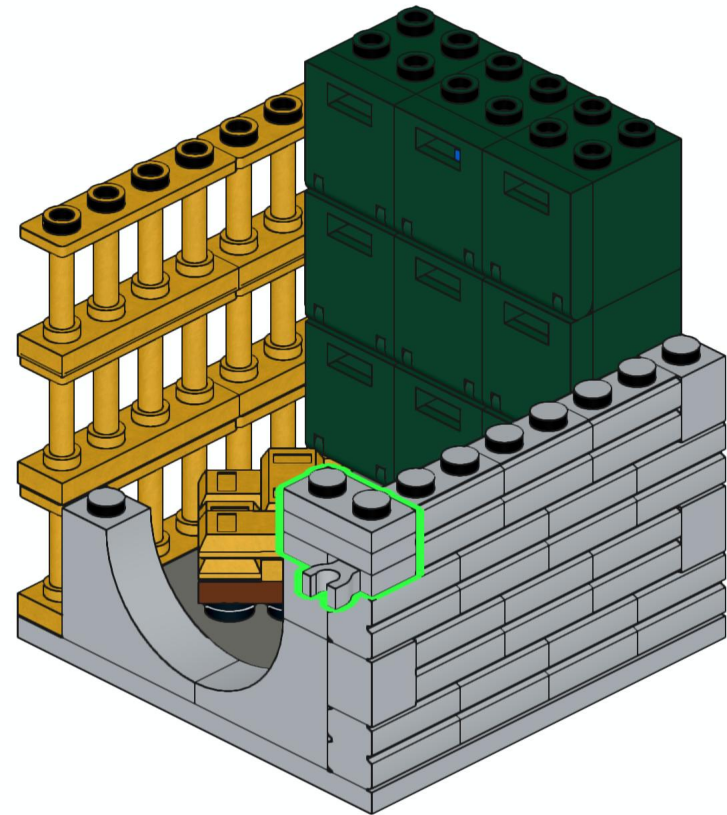
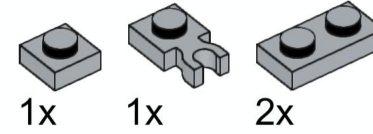

# 308

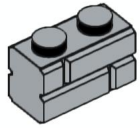

4x

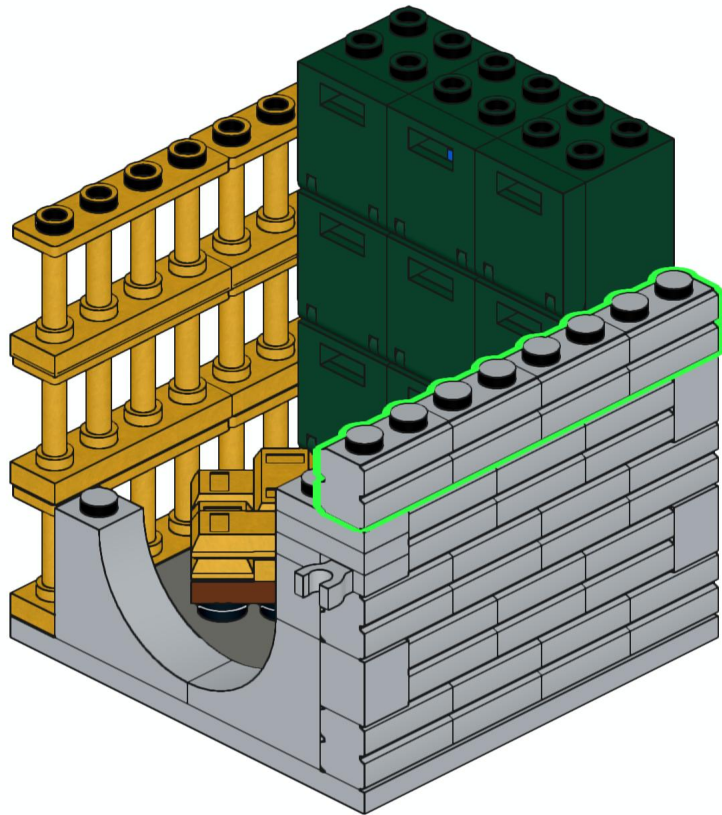

# 309

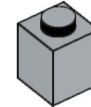

2x

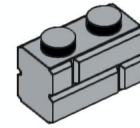

3x

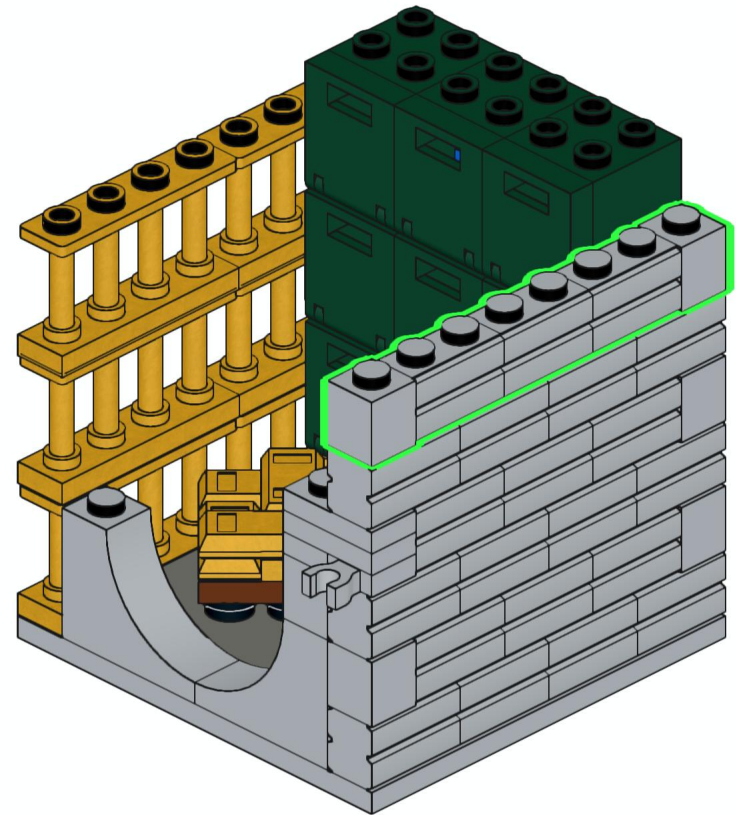



# 310

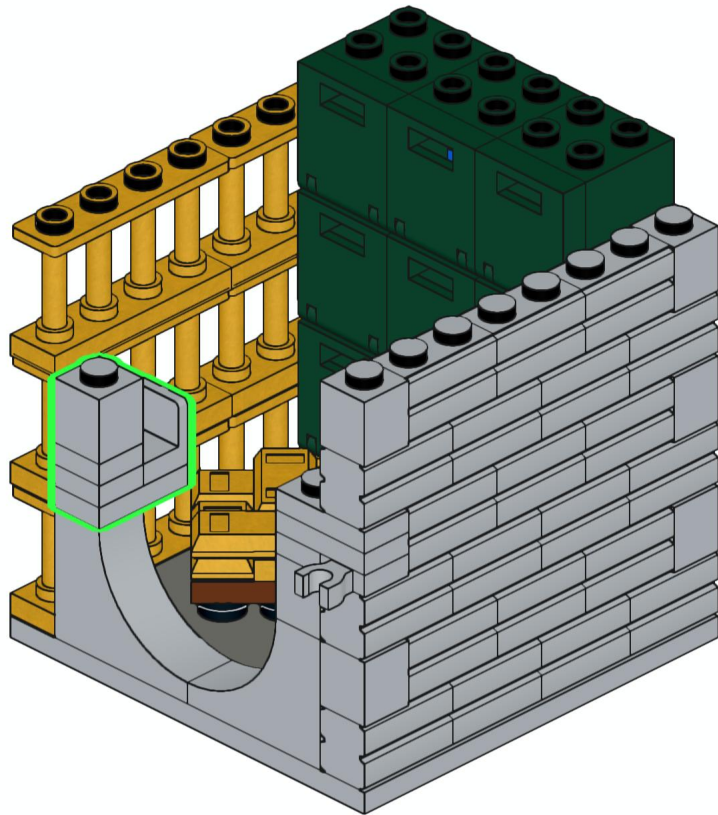
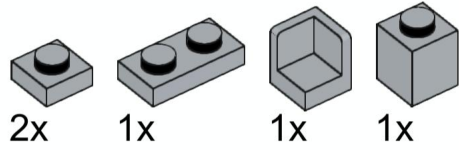

# 311

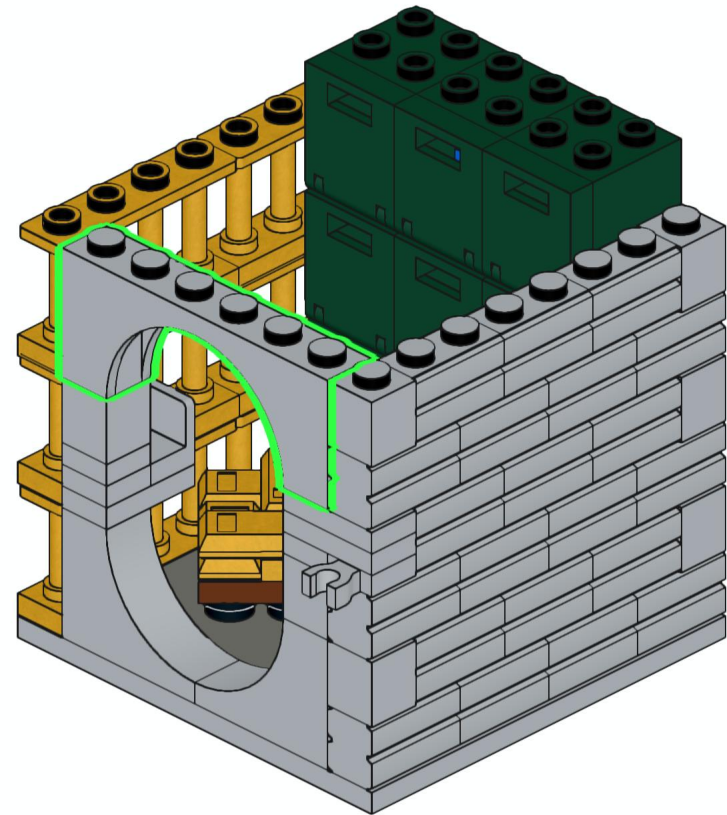
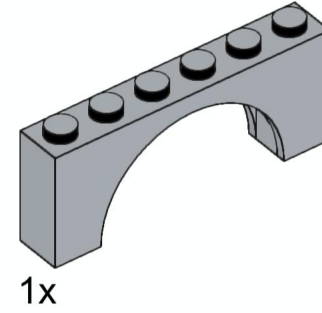

# 312

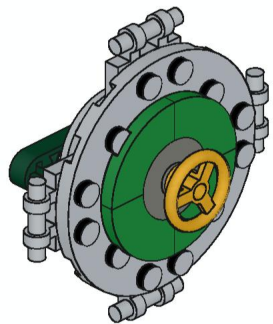
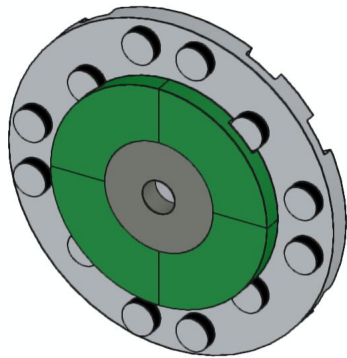
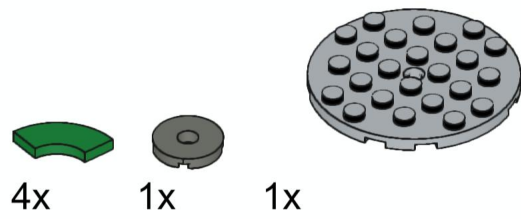

# 313

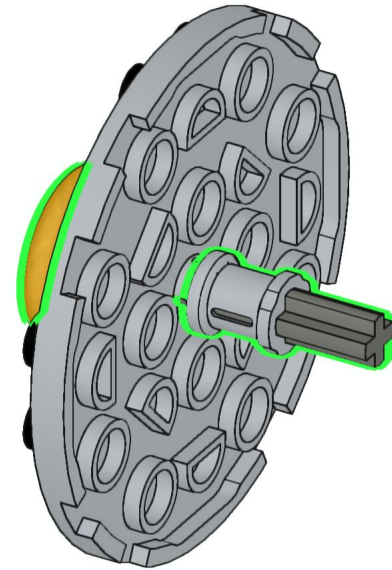
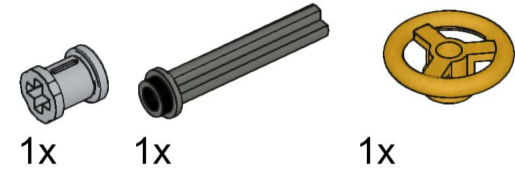

# 314

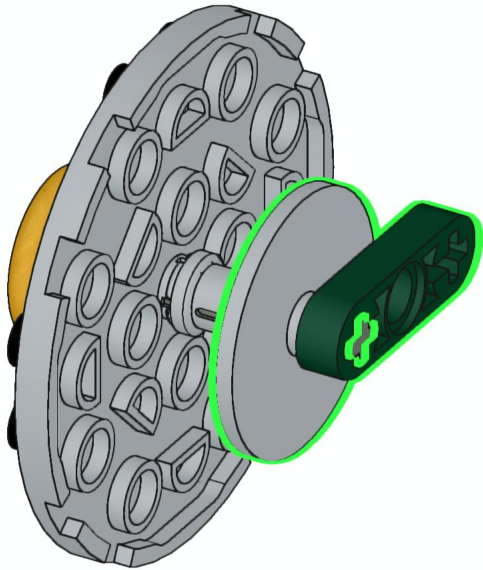
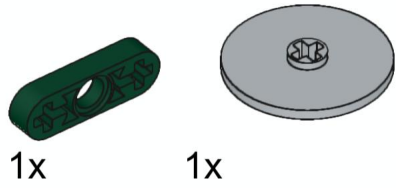

# 315

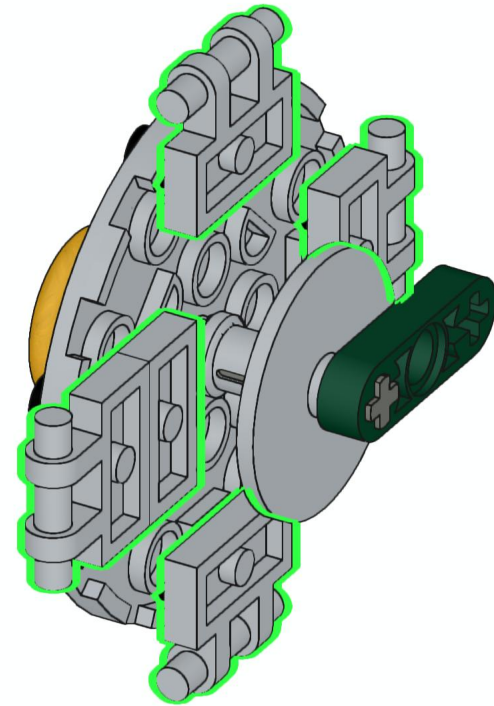
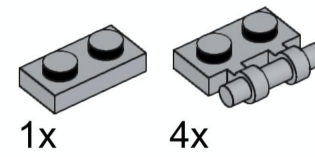

# 316

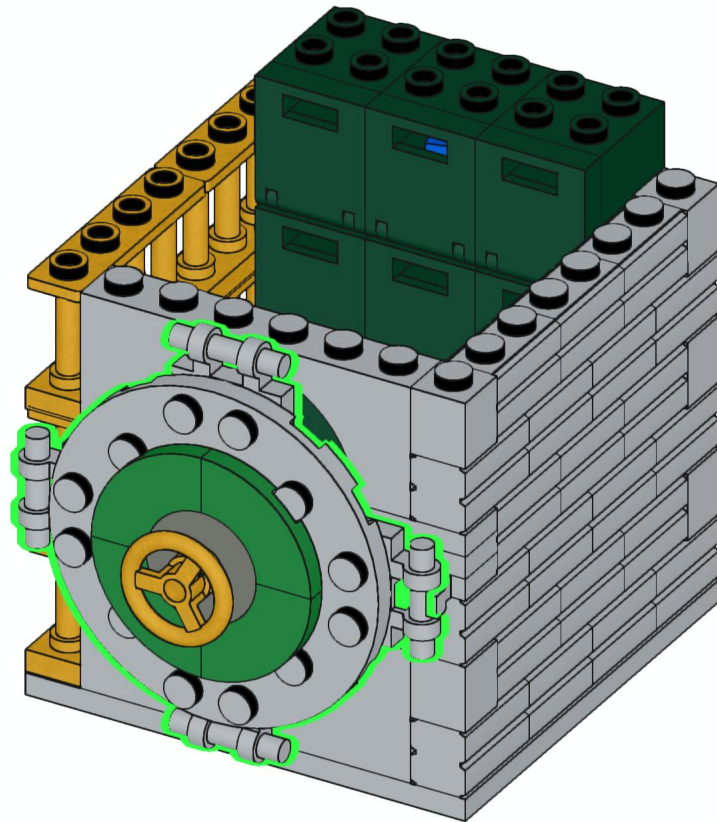

# 317

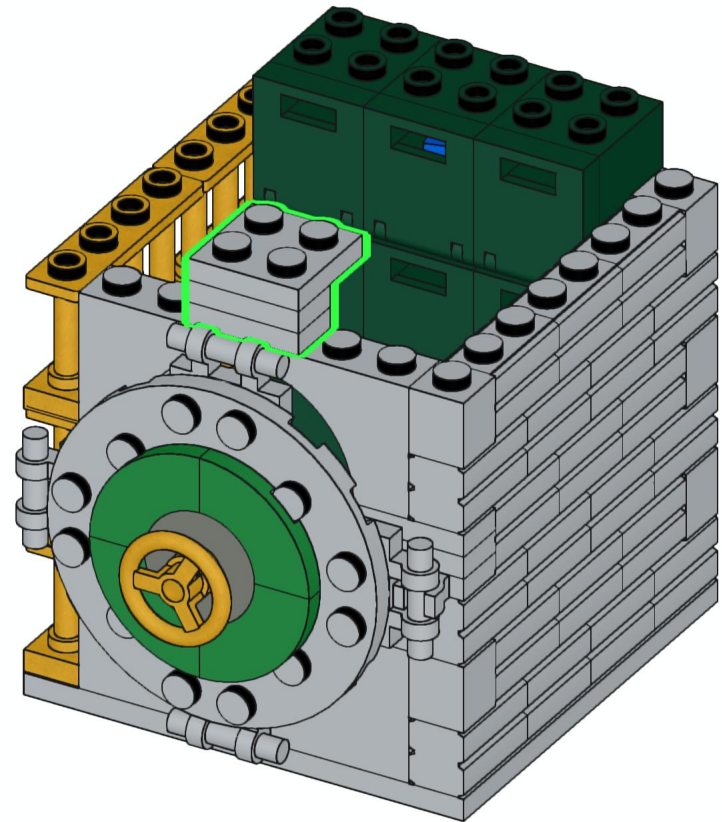
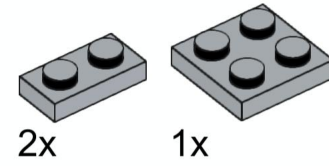

# 318

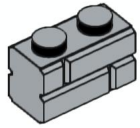

10x

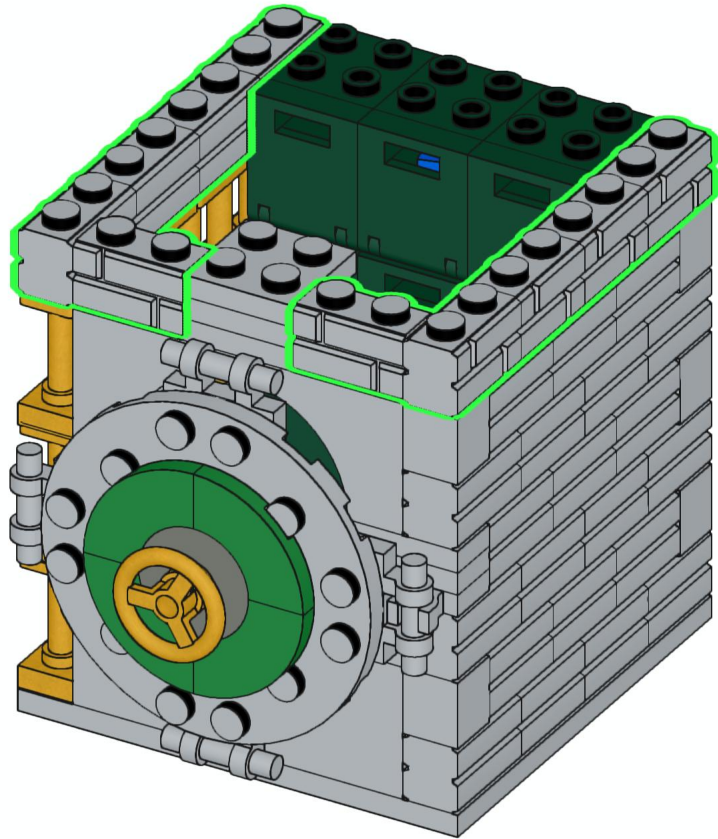

# 319

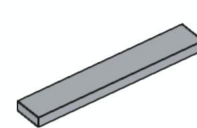

2x

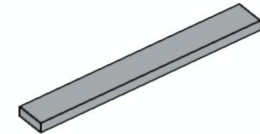

2x

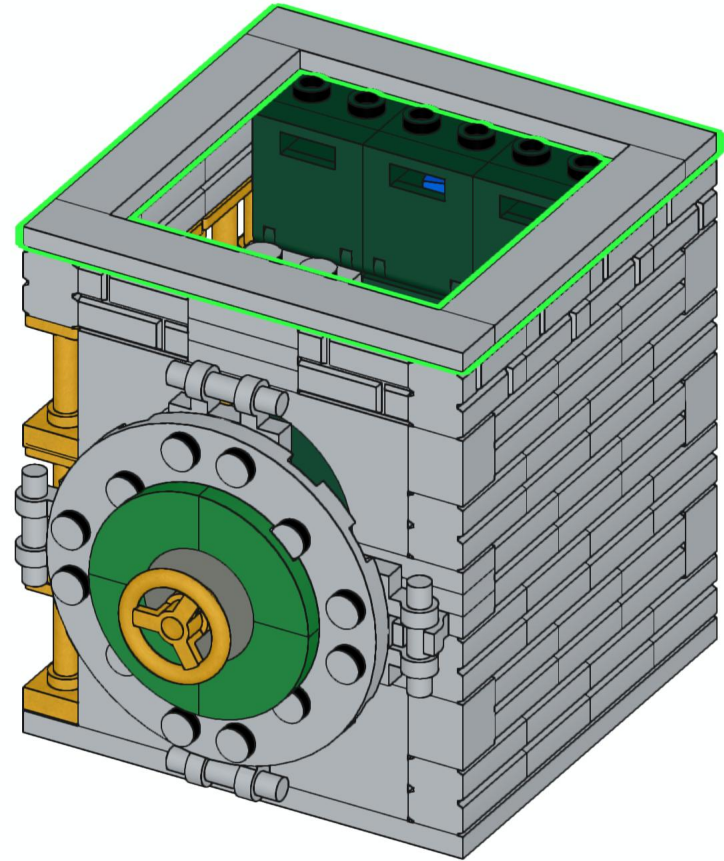

# 320

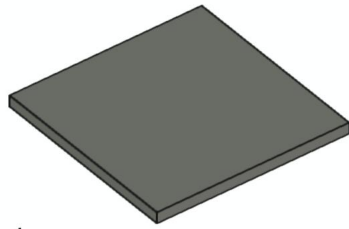

1x



1x

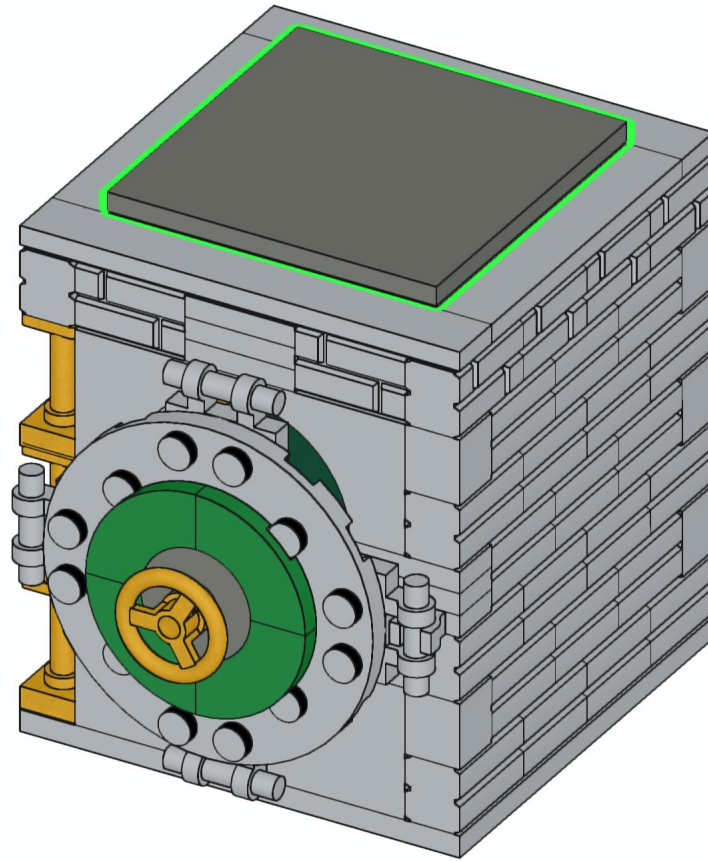

321

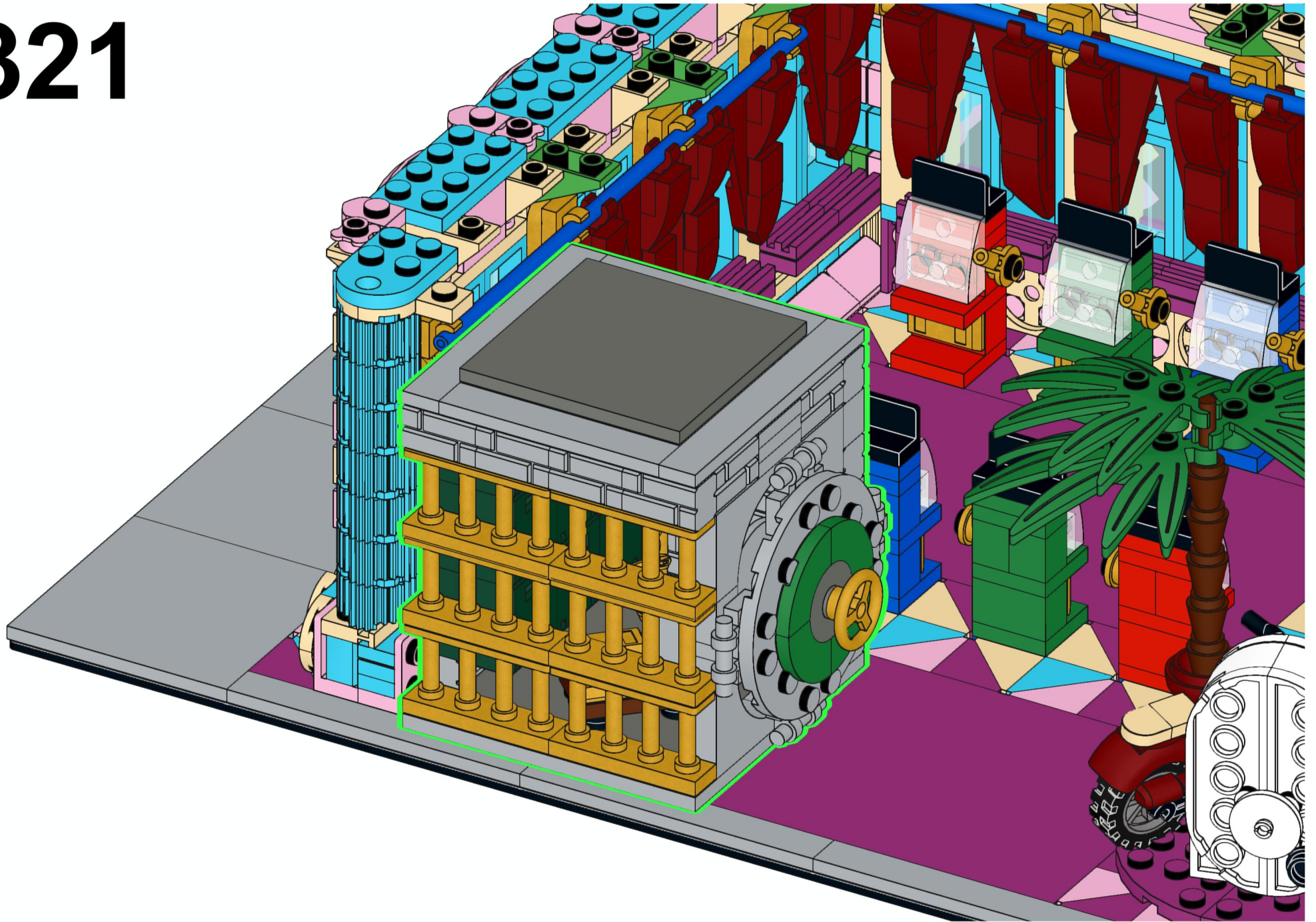

# 322

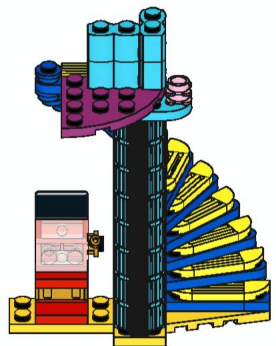
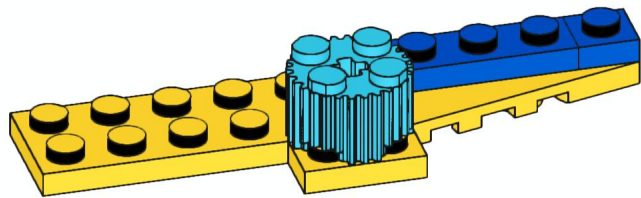
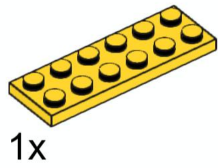
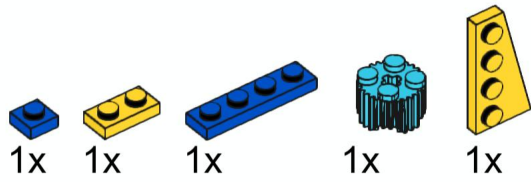

# 323

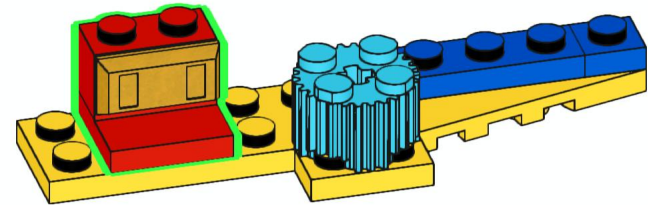
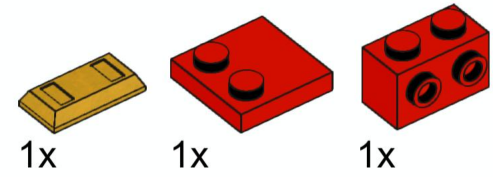



# 324



2x

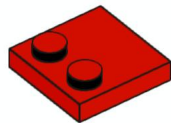

1x

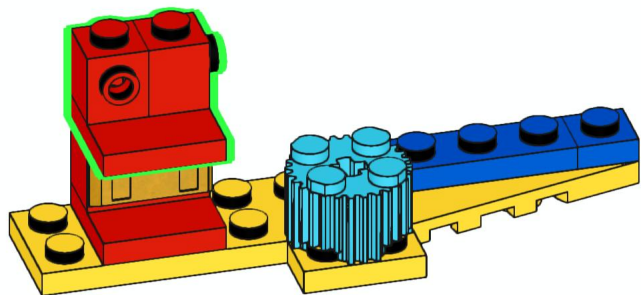

# 325

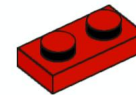

2x

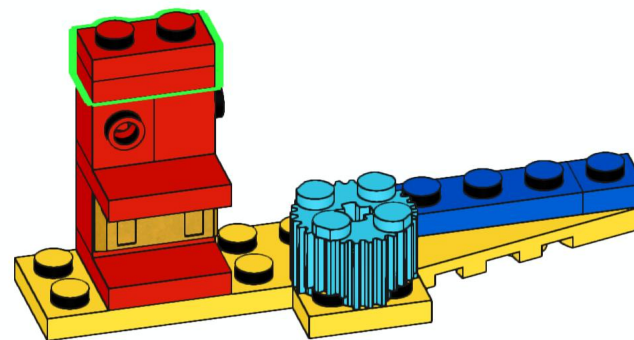

# 326

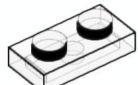

1x

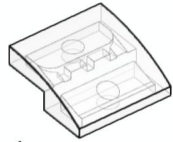

1x

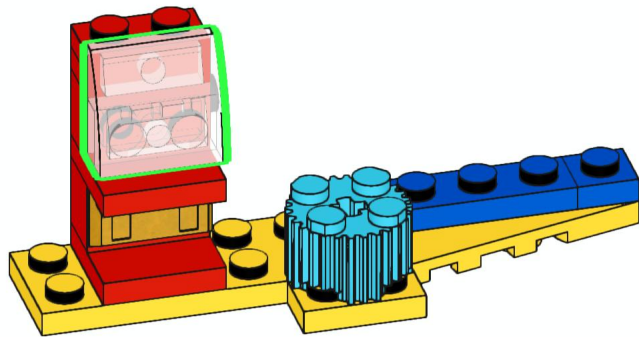

# 327



1x



1x

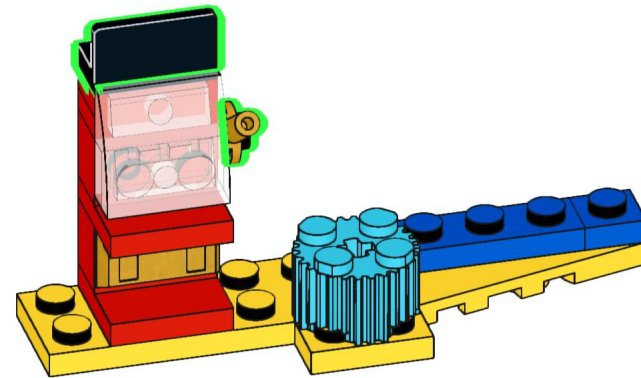

# 328

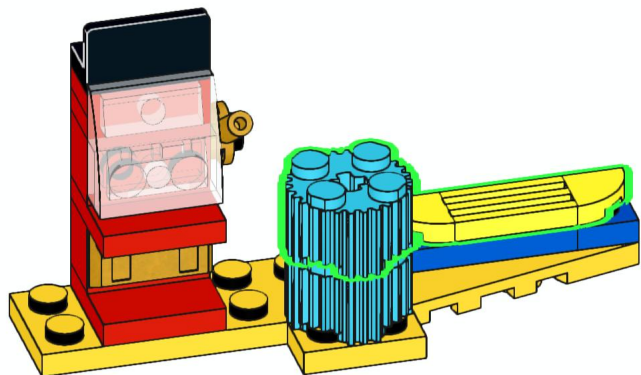
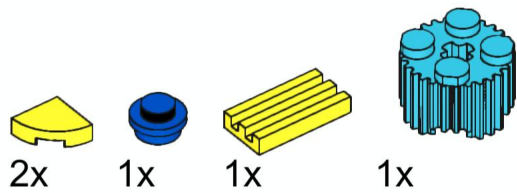

# 329

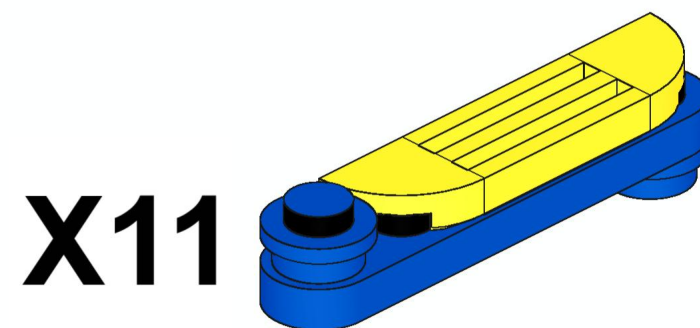
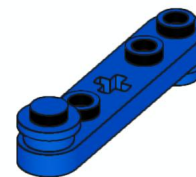
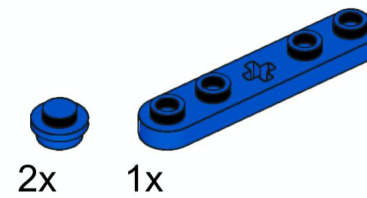

# 330

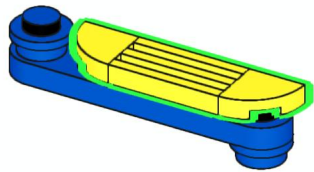
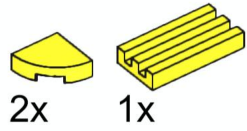

# 331

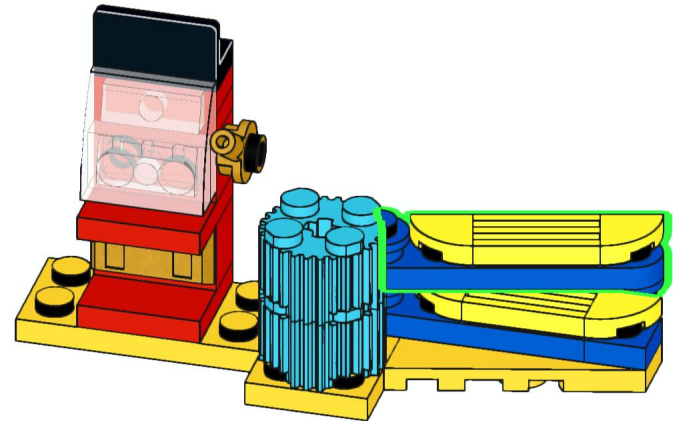

# 332

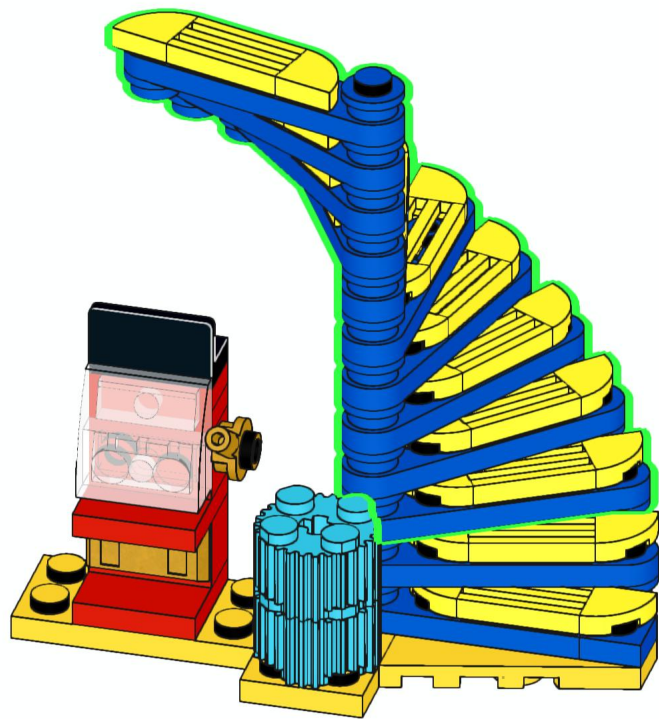

# 333

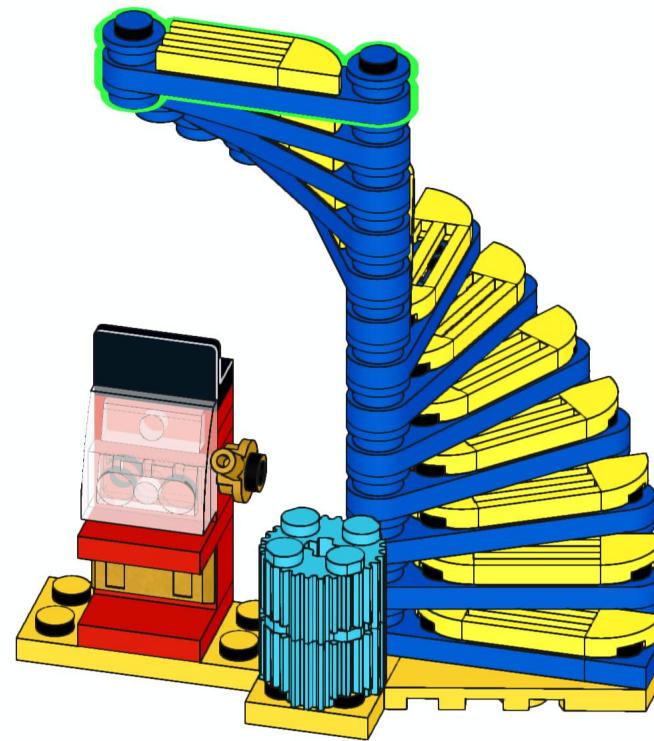
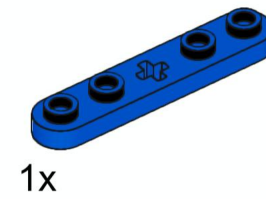
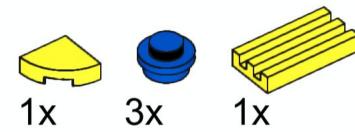

# 334



6x

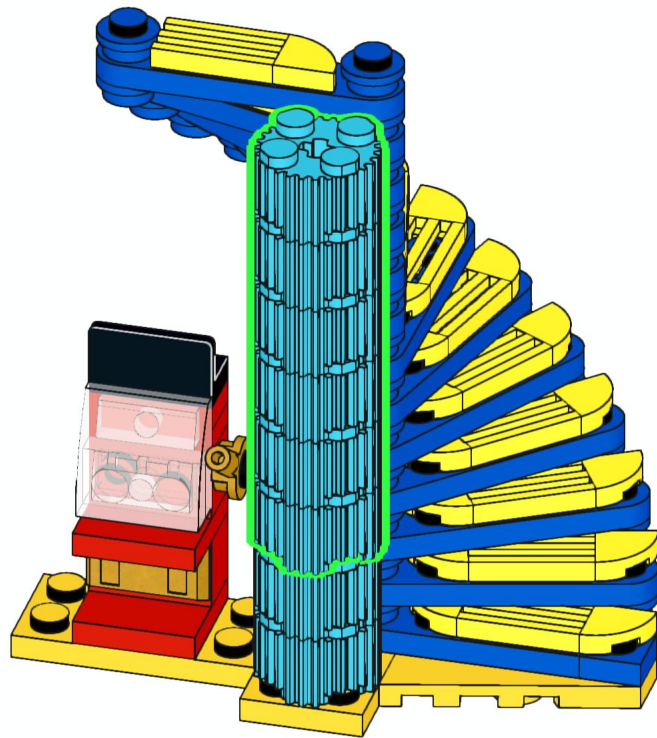

# 335



2x

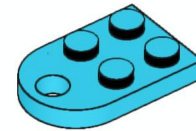

1x

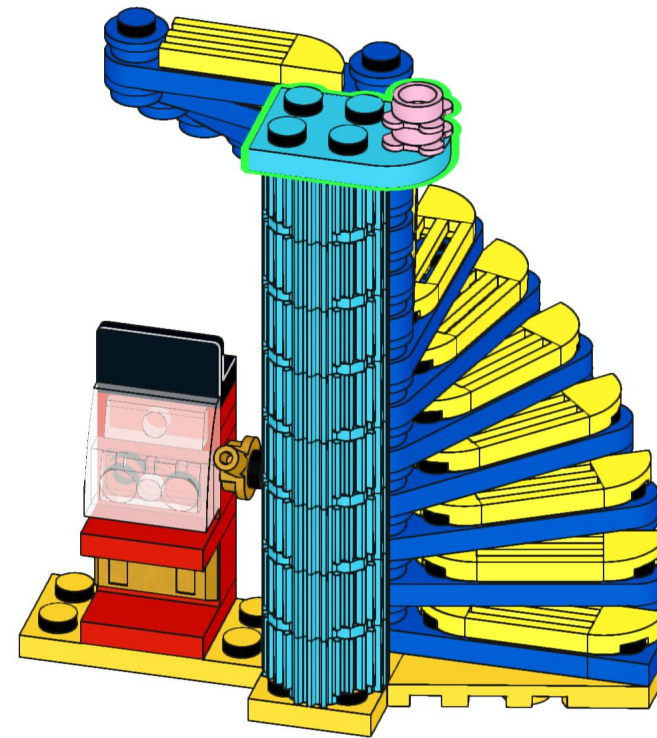

# 336

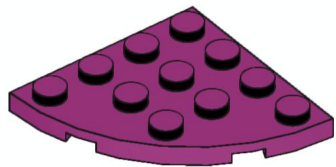

1x

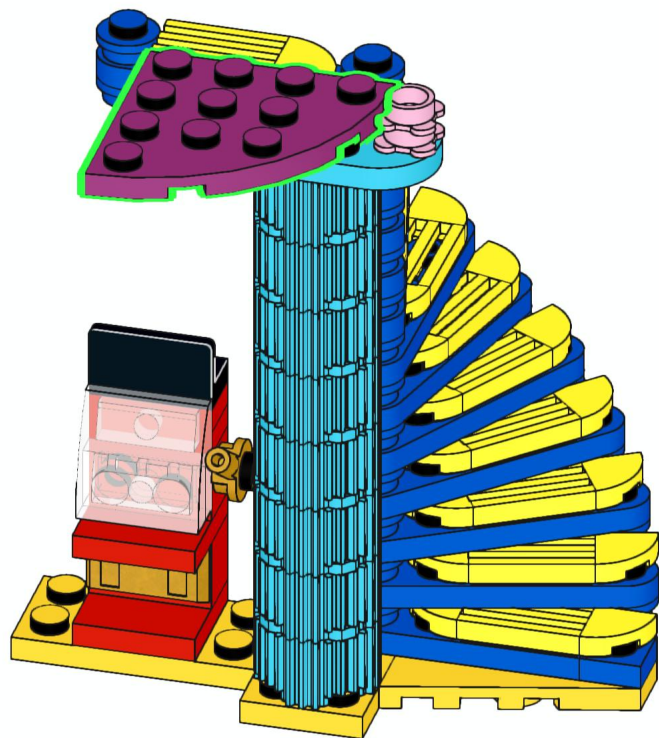

# 337

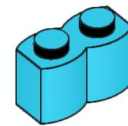

4x

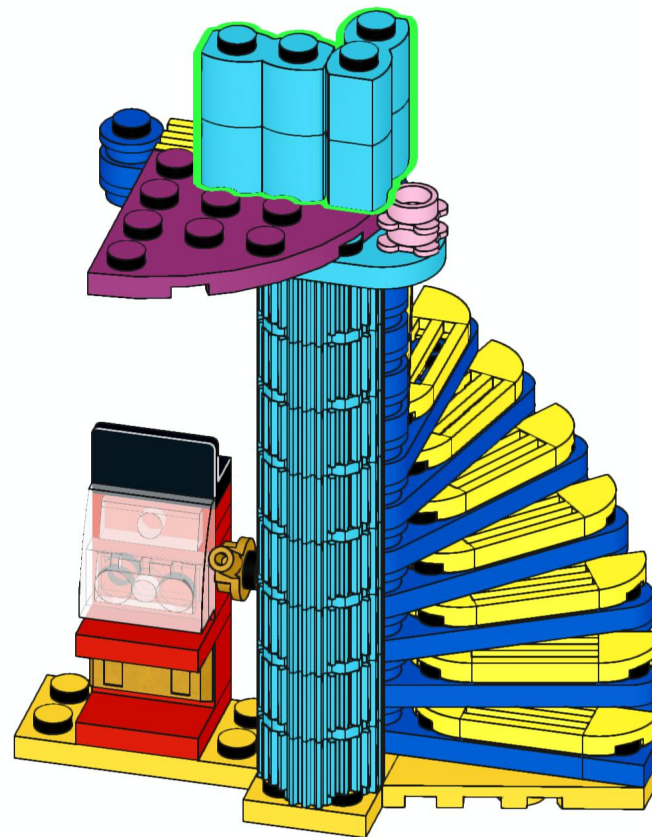

# 338





# 339



# 340

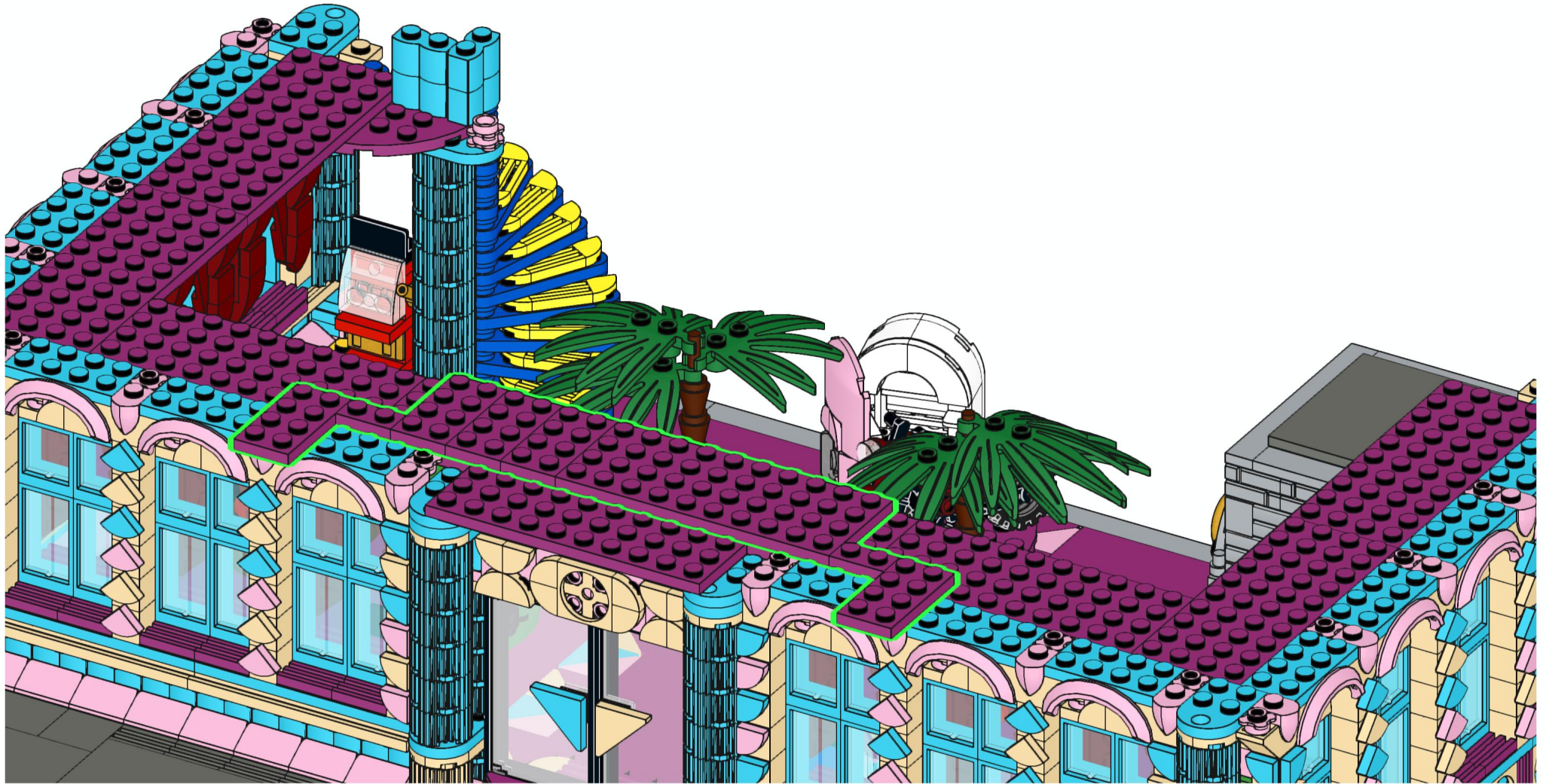
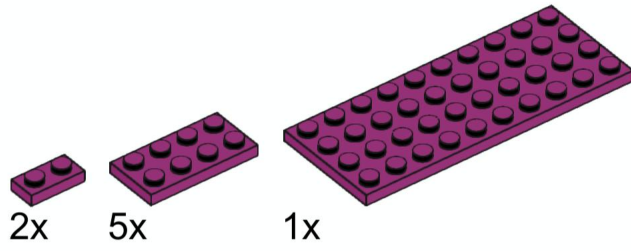

# 341

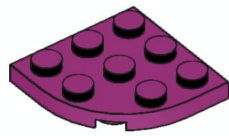

2x

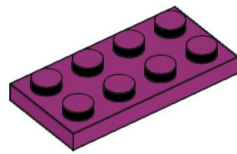

16x



# 342



2x

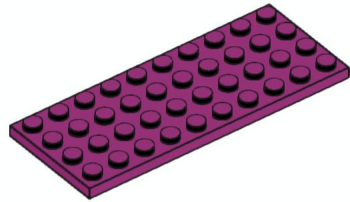

6x

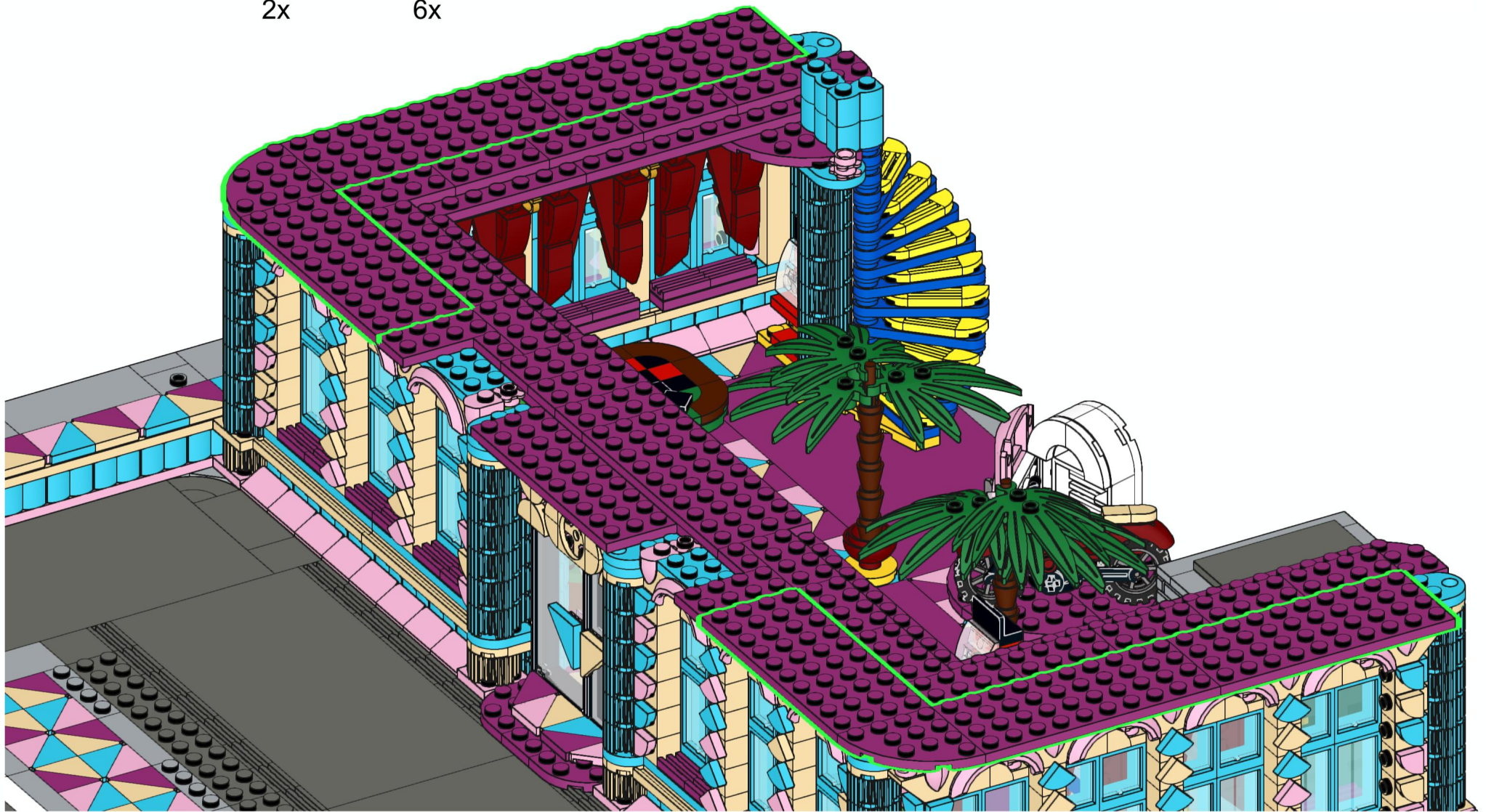

# 343

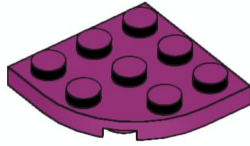

4x



# 344

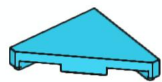

19x



22x

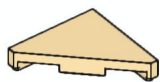

21x

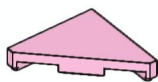

18x



# 345

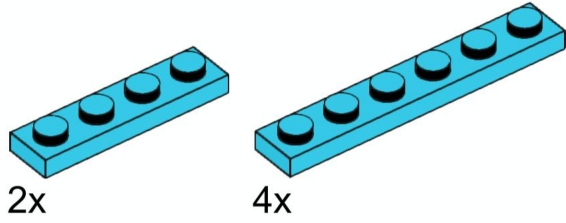

# 346

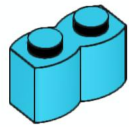

28x





# 347

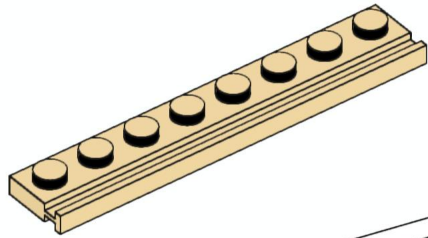

9x



# 348

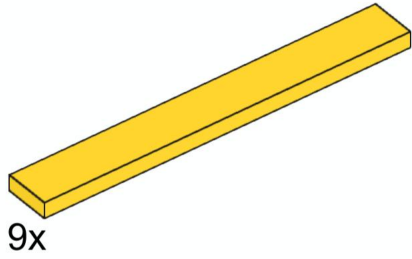

# 349



1x



1x

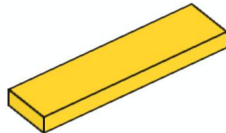

1x



# 350

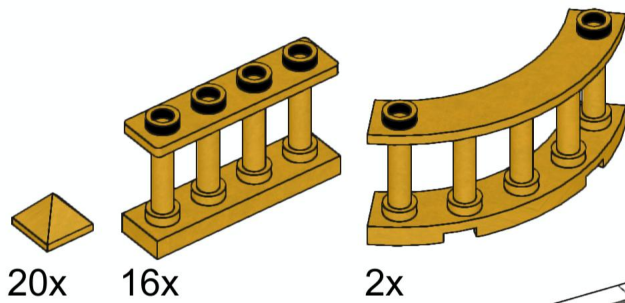

# 351

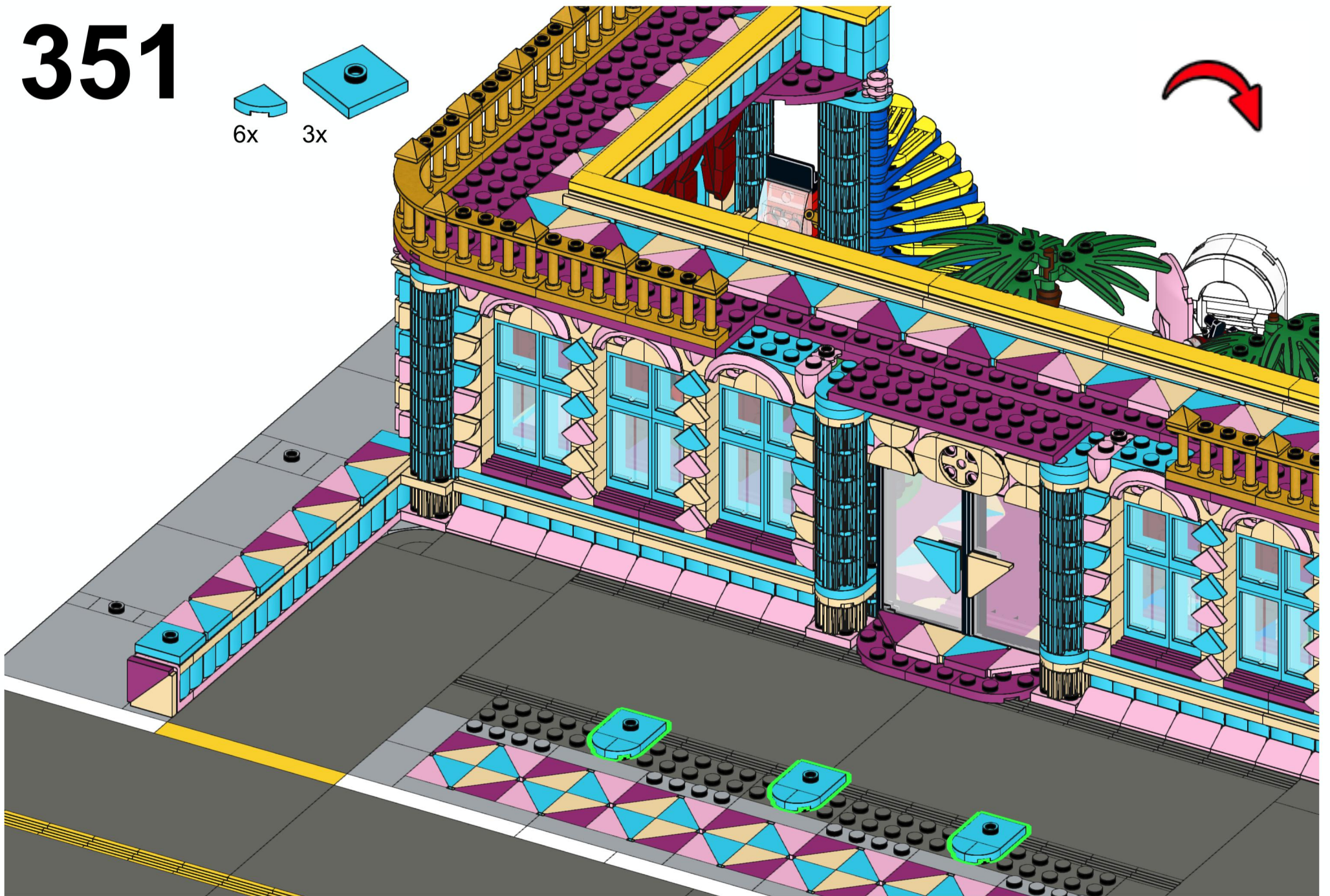
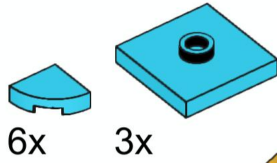

# 352



3x

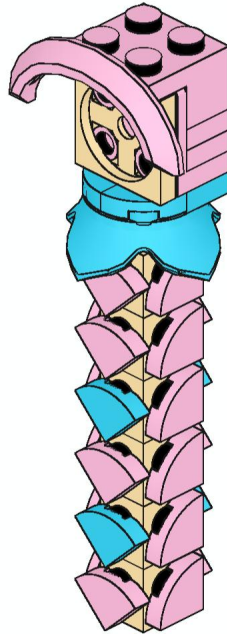
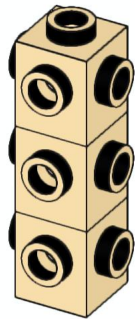

# X3

# 353



3x

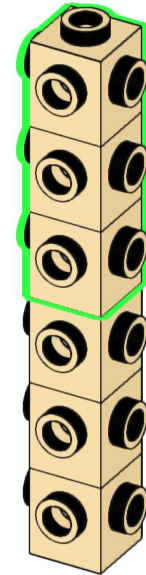

# 354

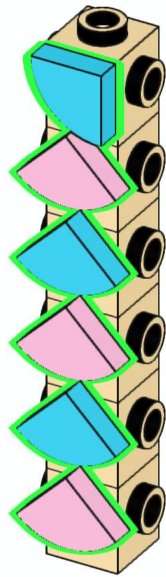
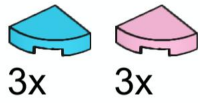

# 355

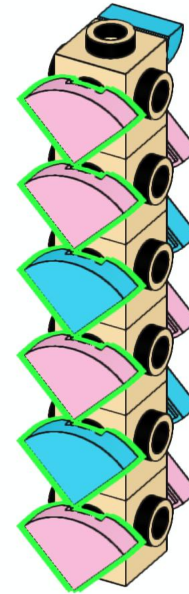
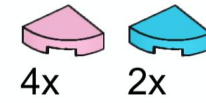

# 356



6x



# 357

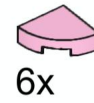

6x

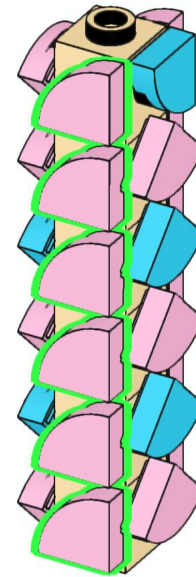
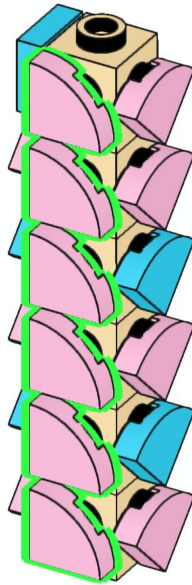



# 358



1x

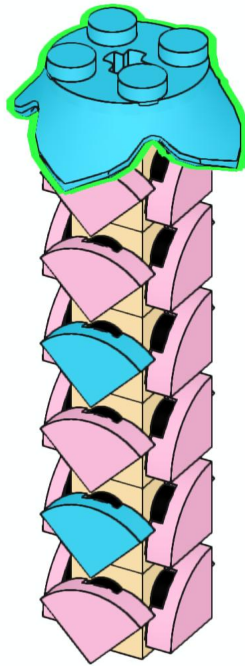

# 359

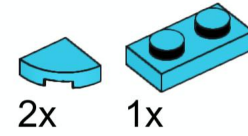

2x

1x

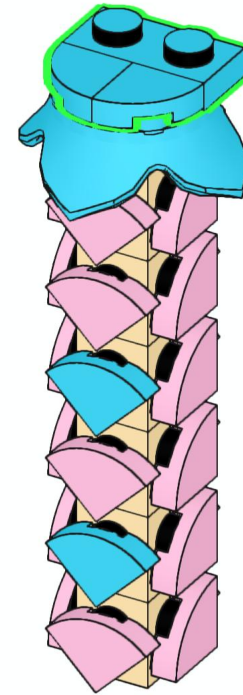

# 360

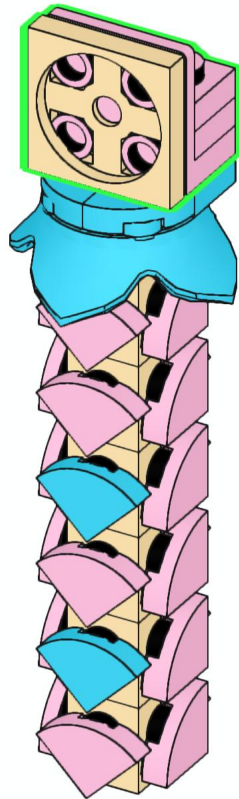
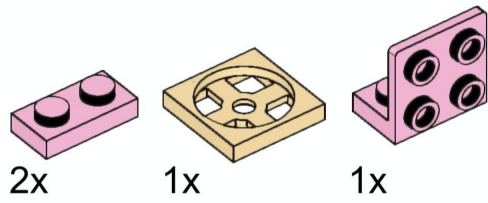

# 361

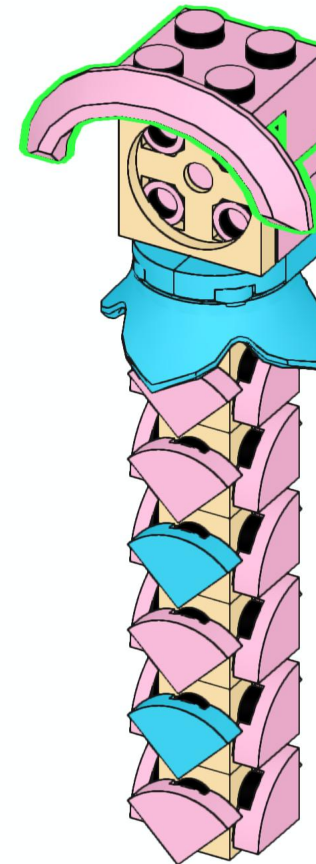
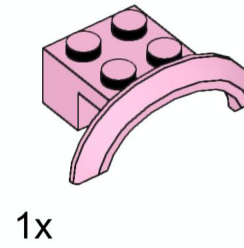

362

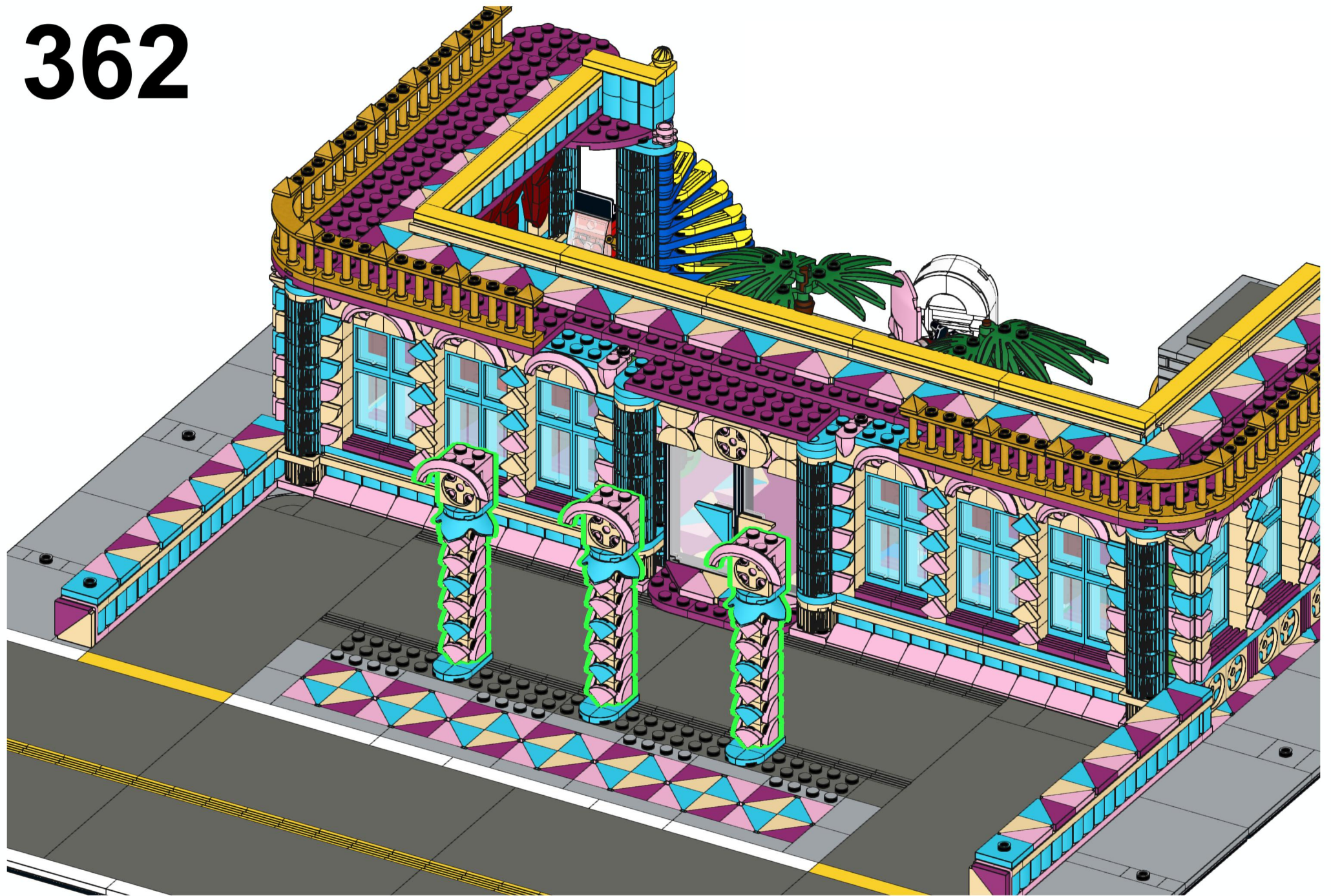

# 363

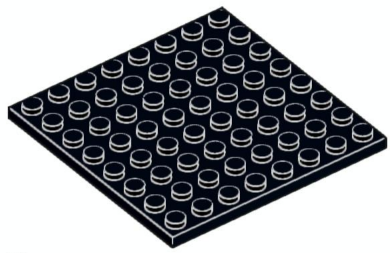

2x

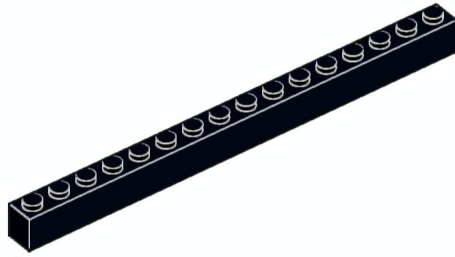

1x

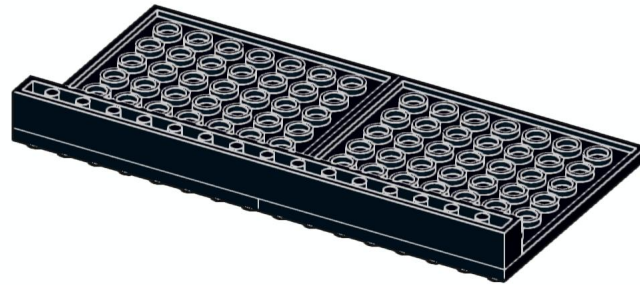
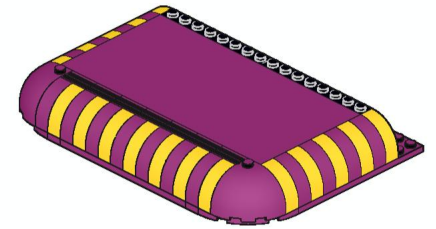

# 364

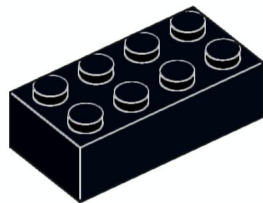

4x

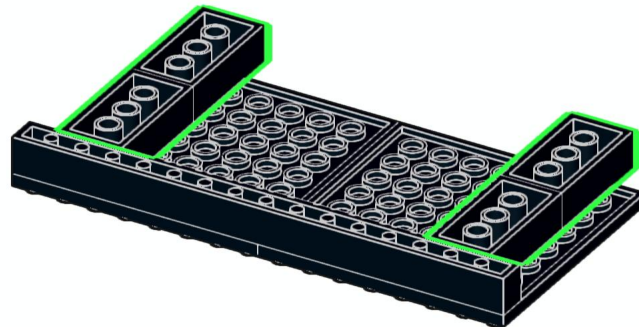

# 365

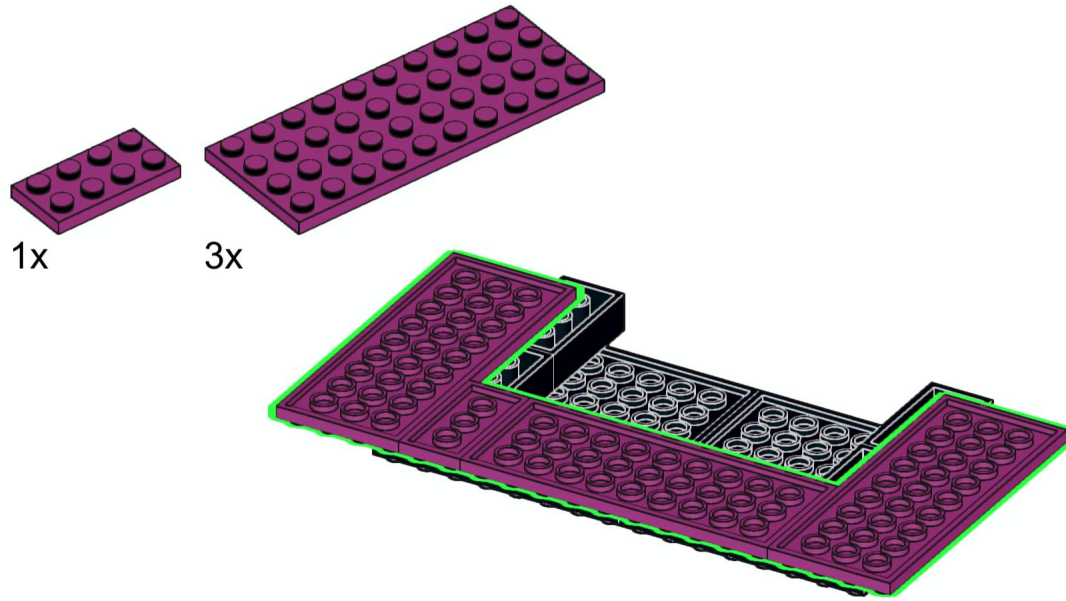

# 366

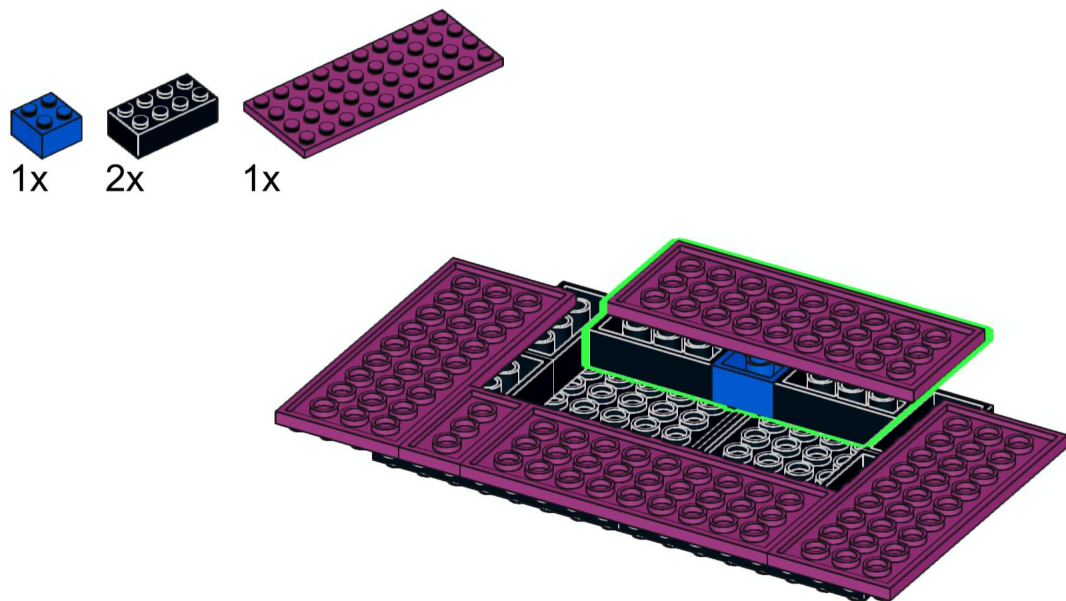

# 367

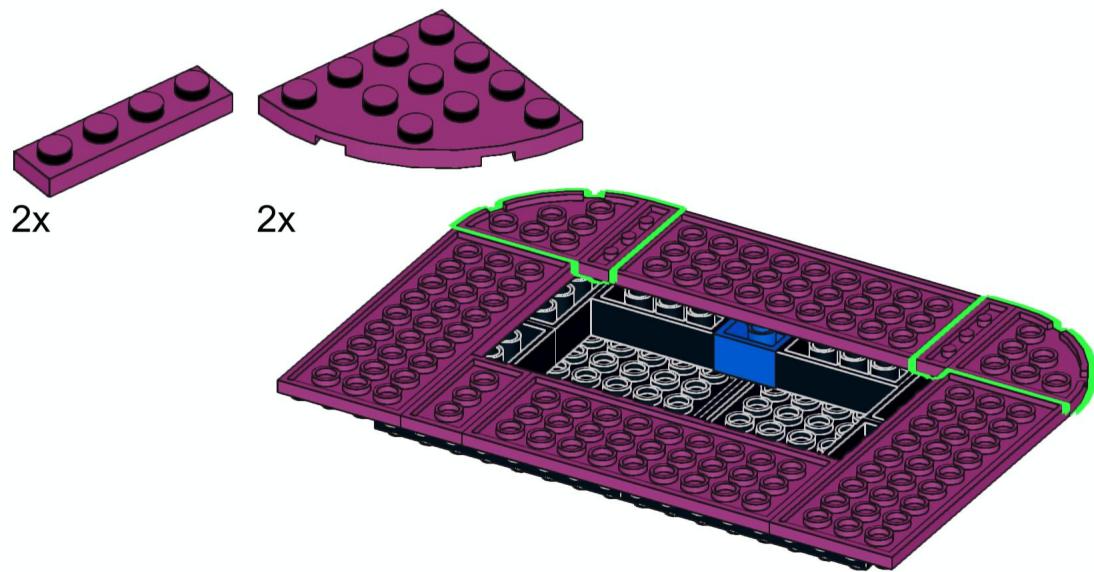

# 368

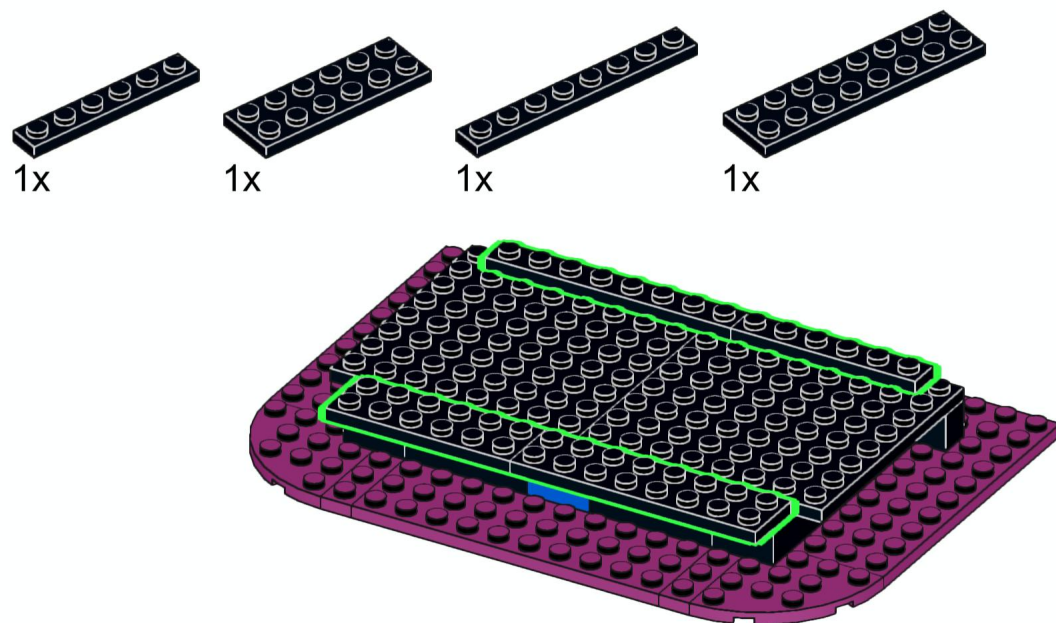

# 369

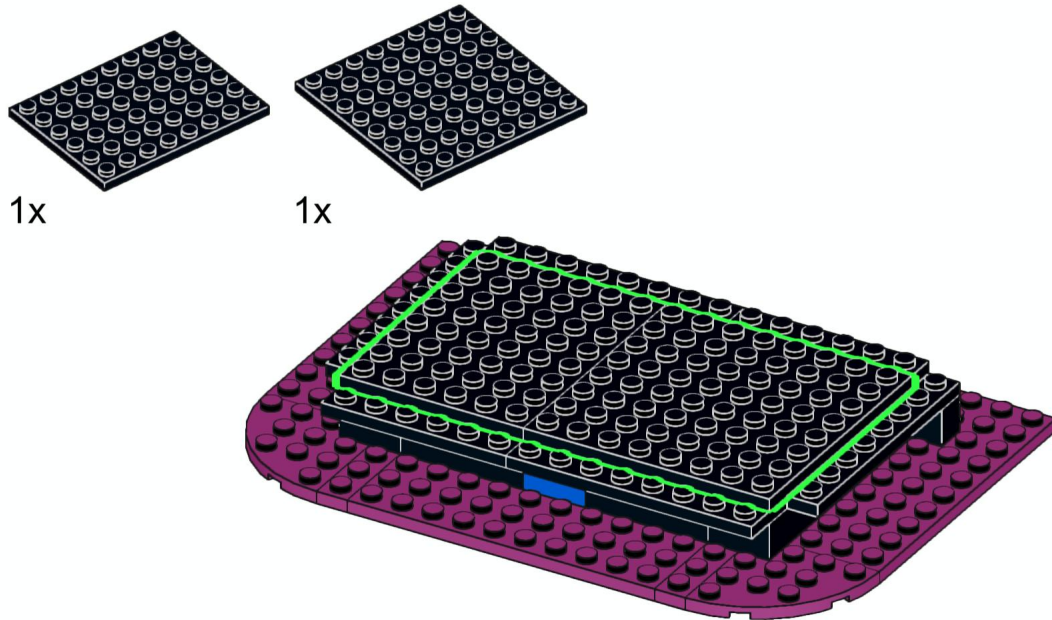

# 370

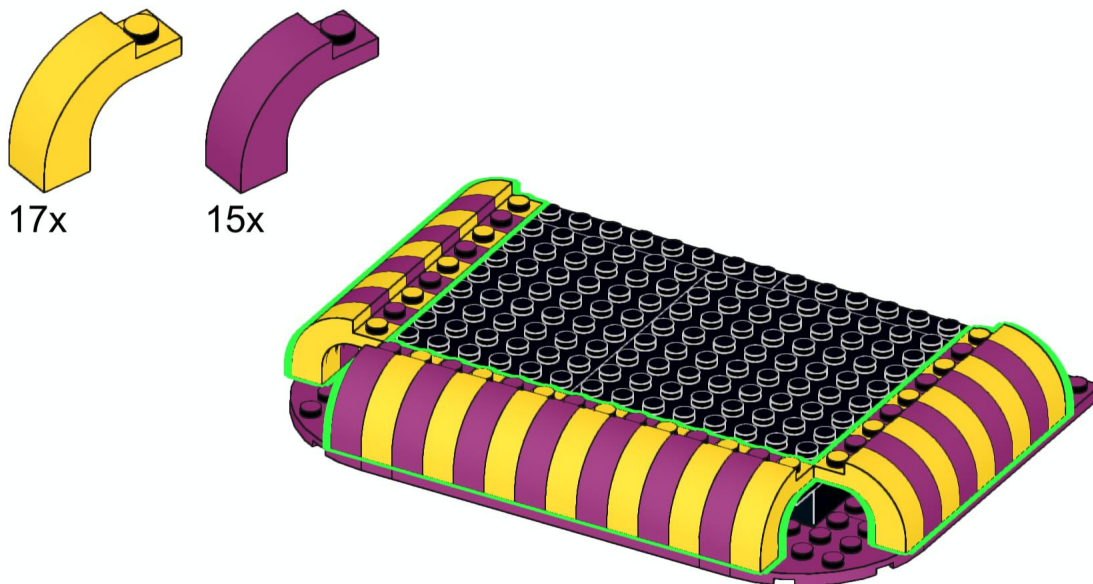

# 371

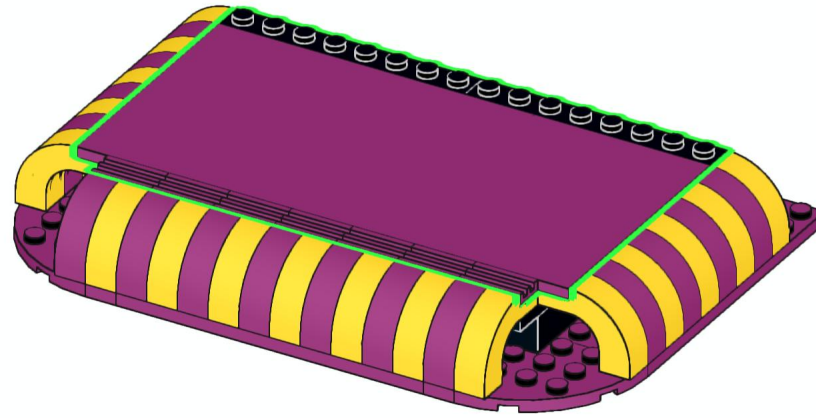
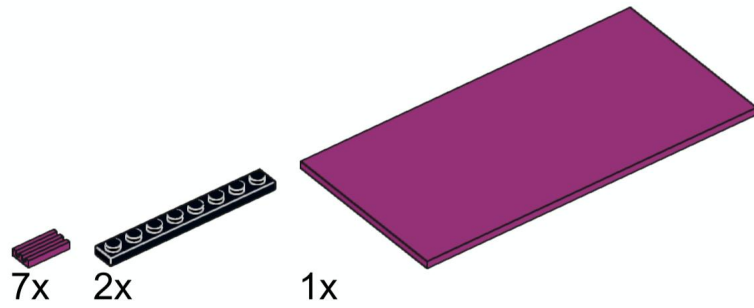

# 372

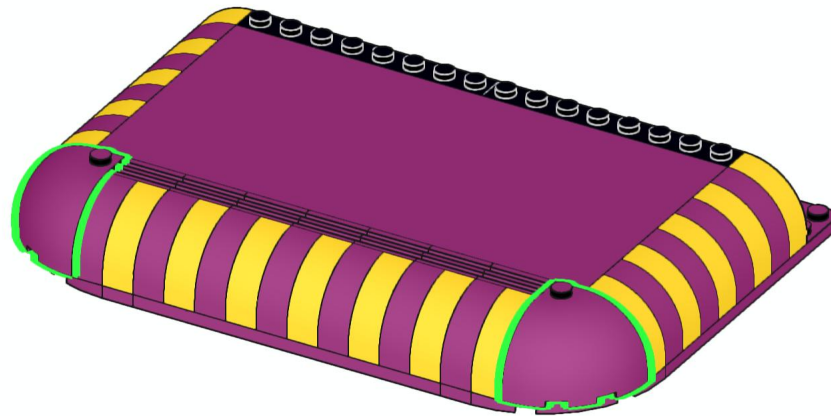
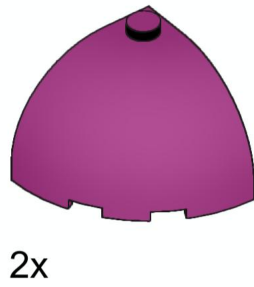



373

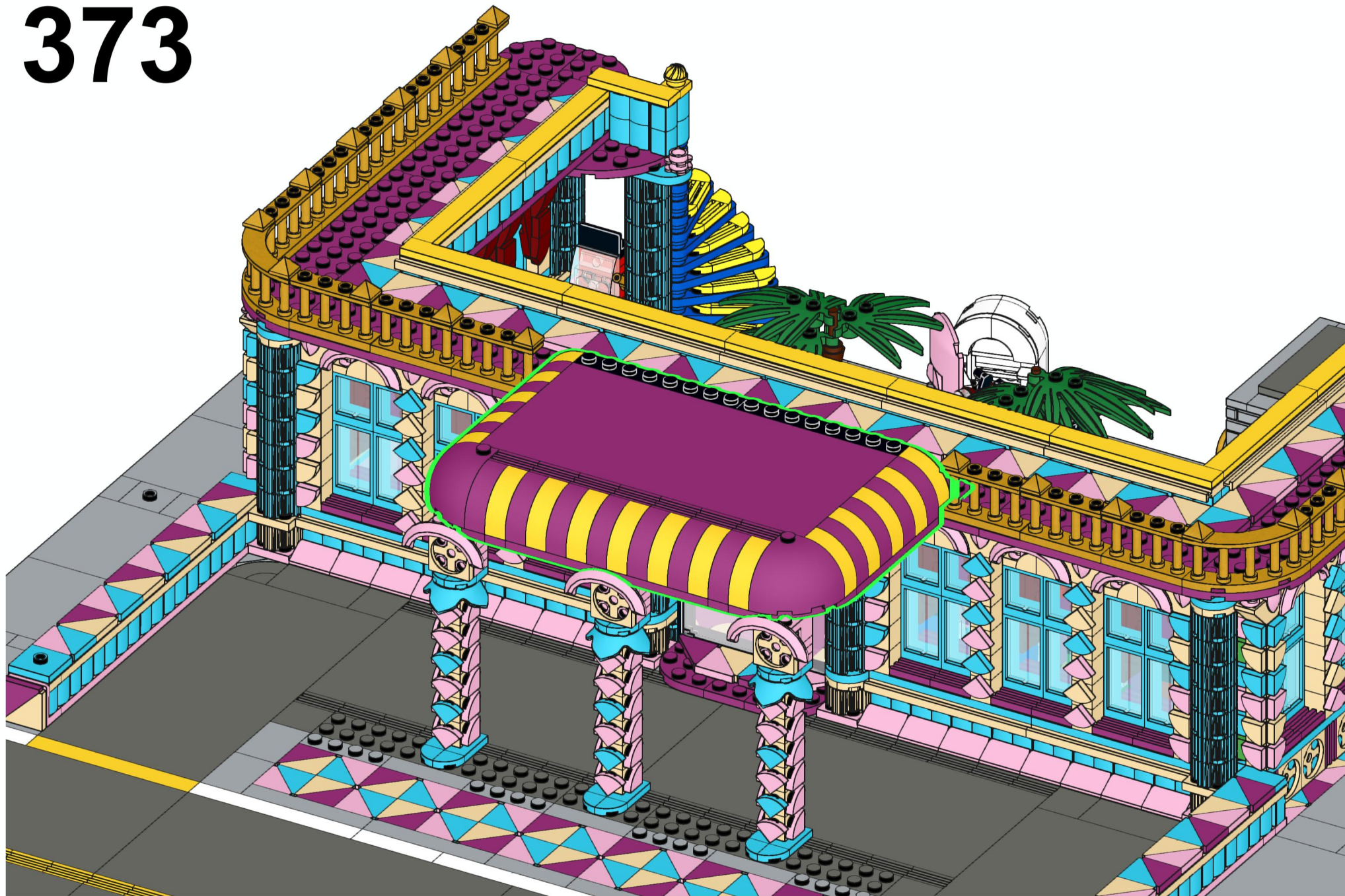

# 374

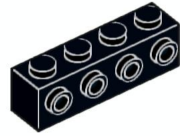

3x



1x



1x



# 375

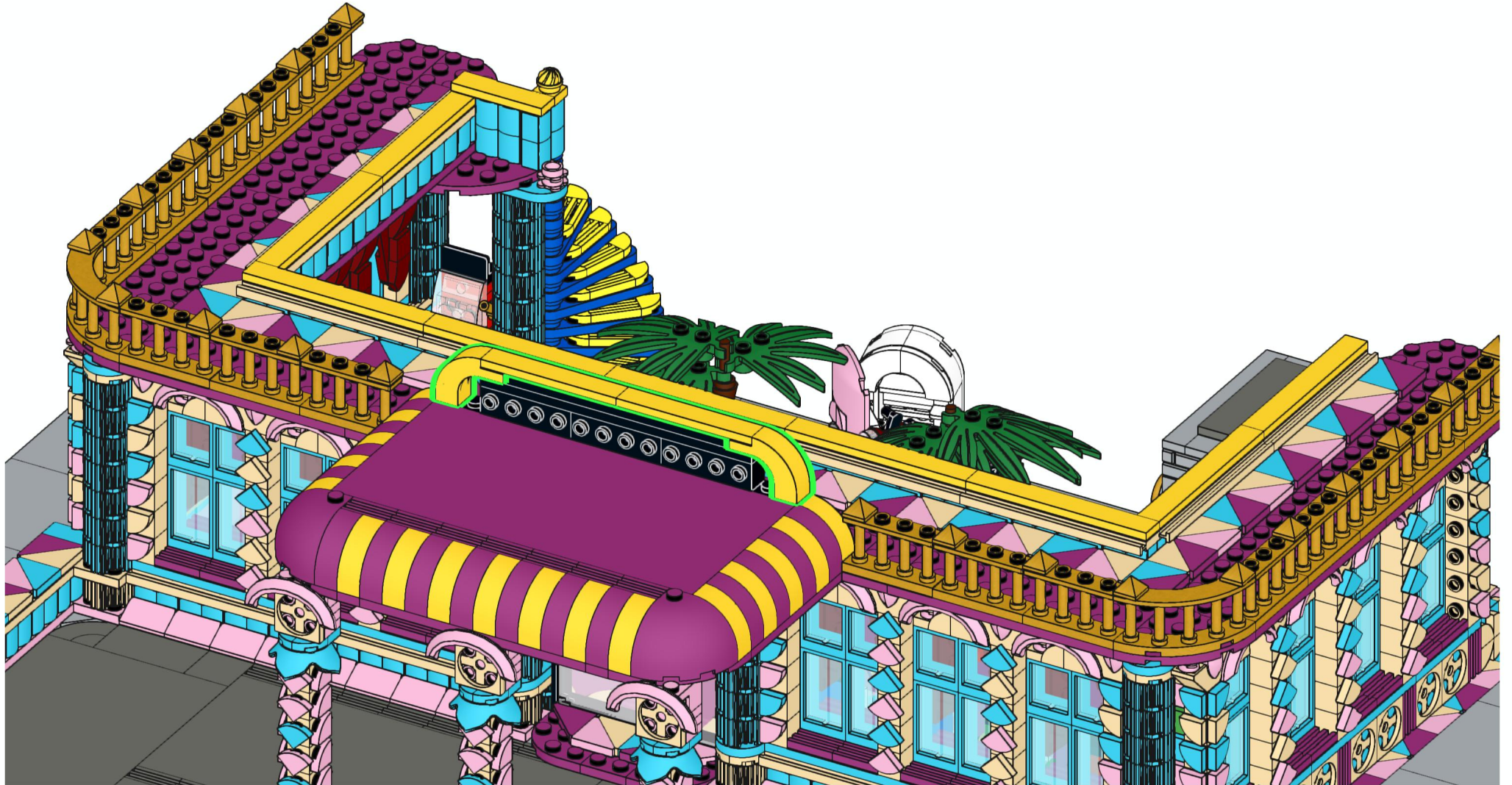
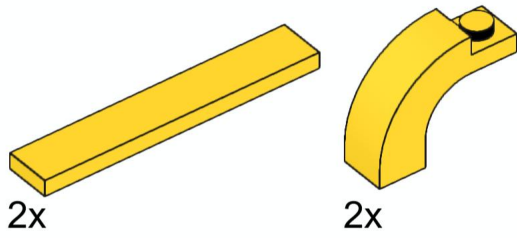

# 376

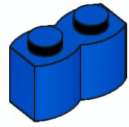

27x

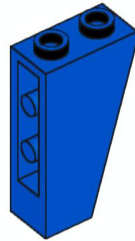

2x



# 377

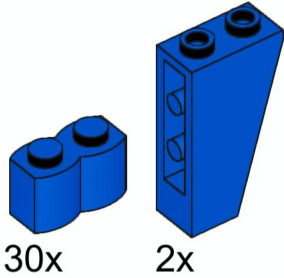

# 378

2x

1x

3x

2x



# 379



2x

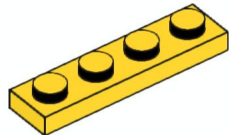

2x

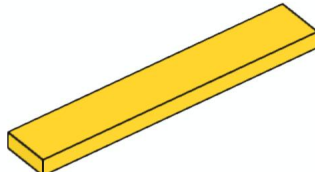

2x



# 380

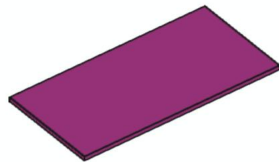

1x

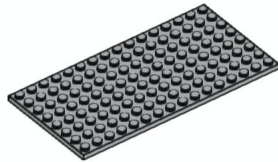

1x

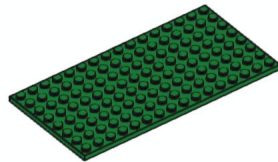

1x

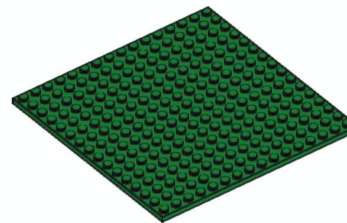

2x

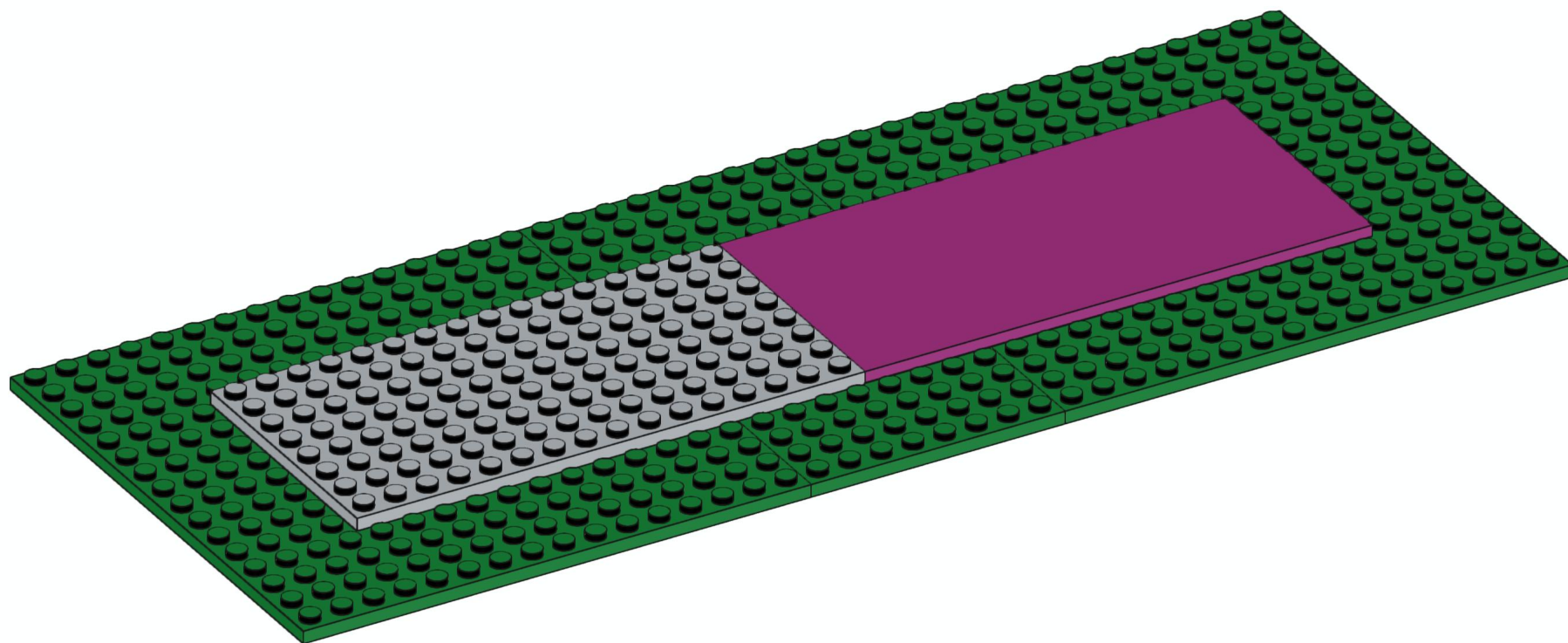
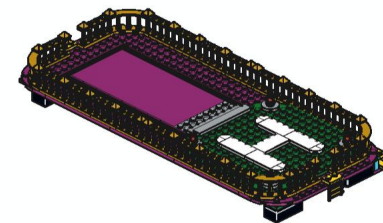



# 381

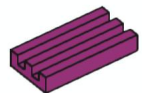

25x

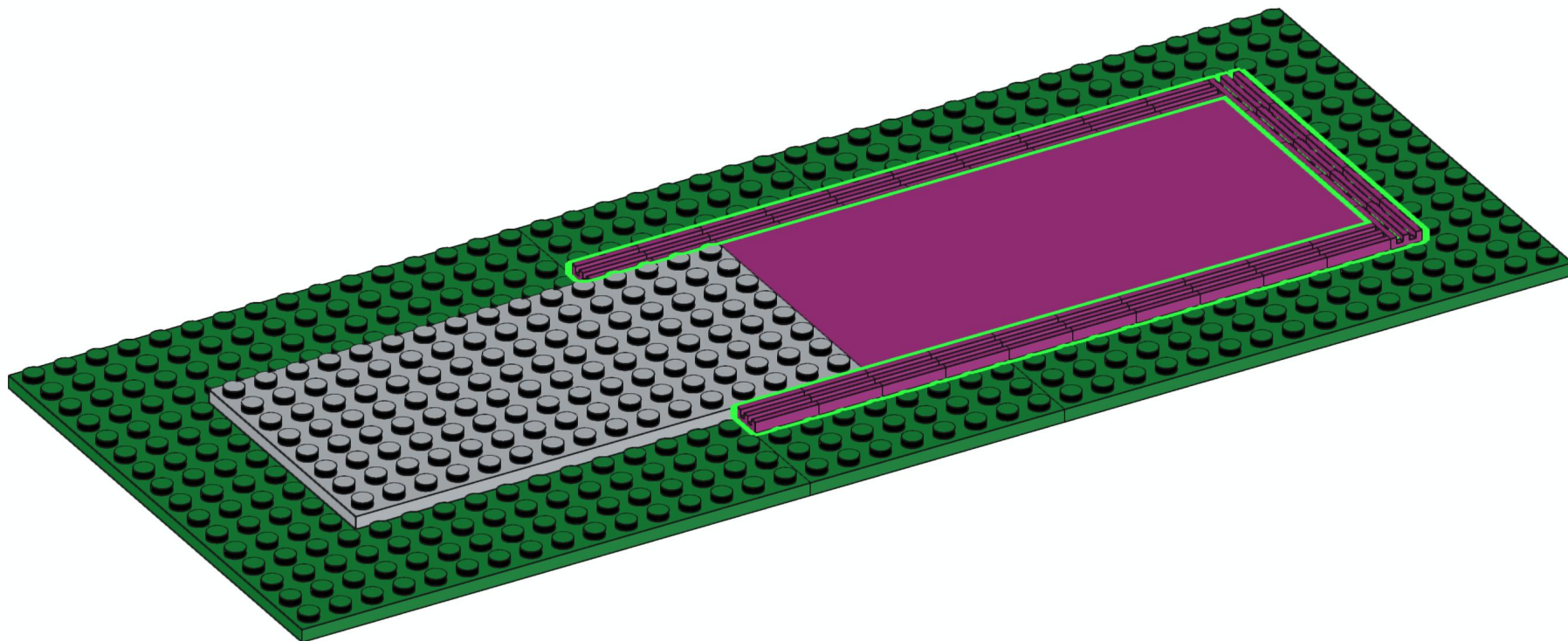

# 382

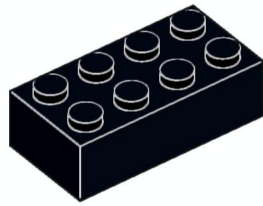

10x

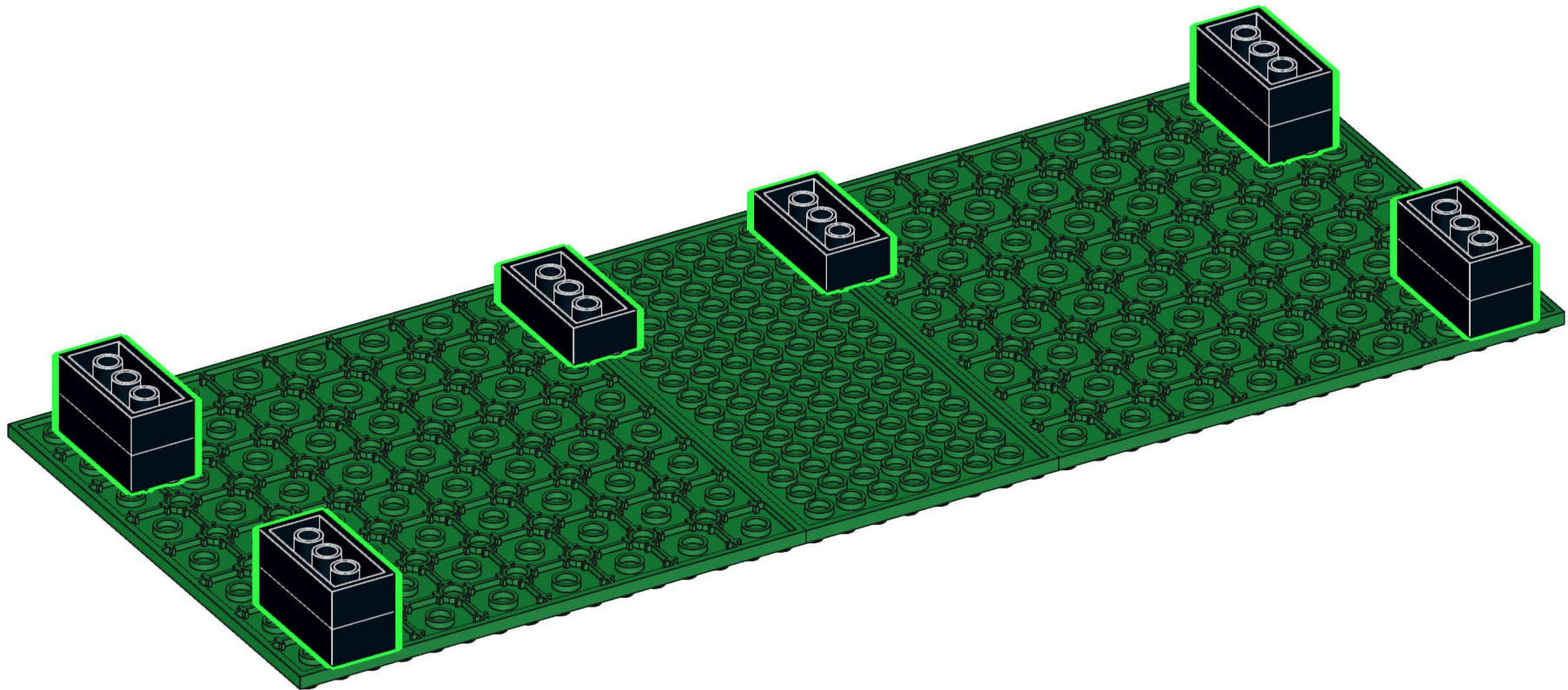

# 383

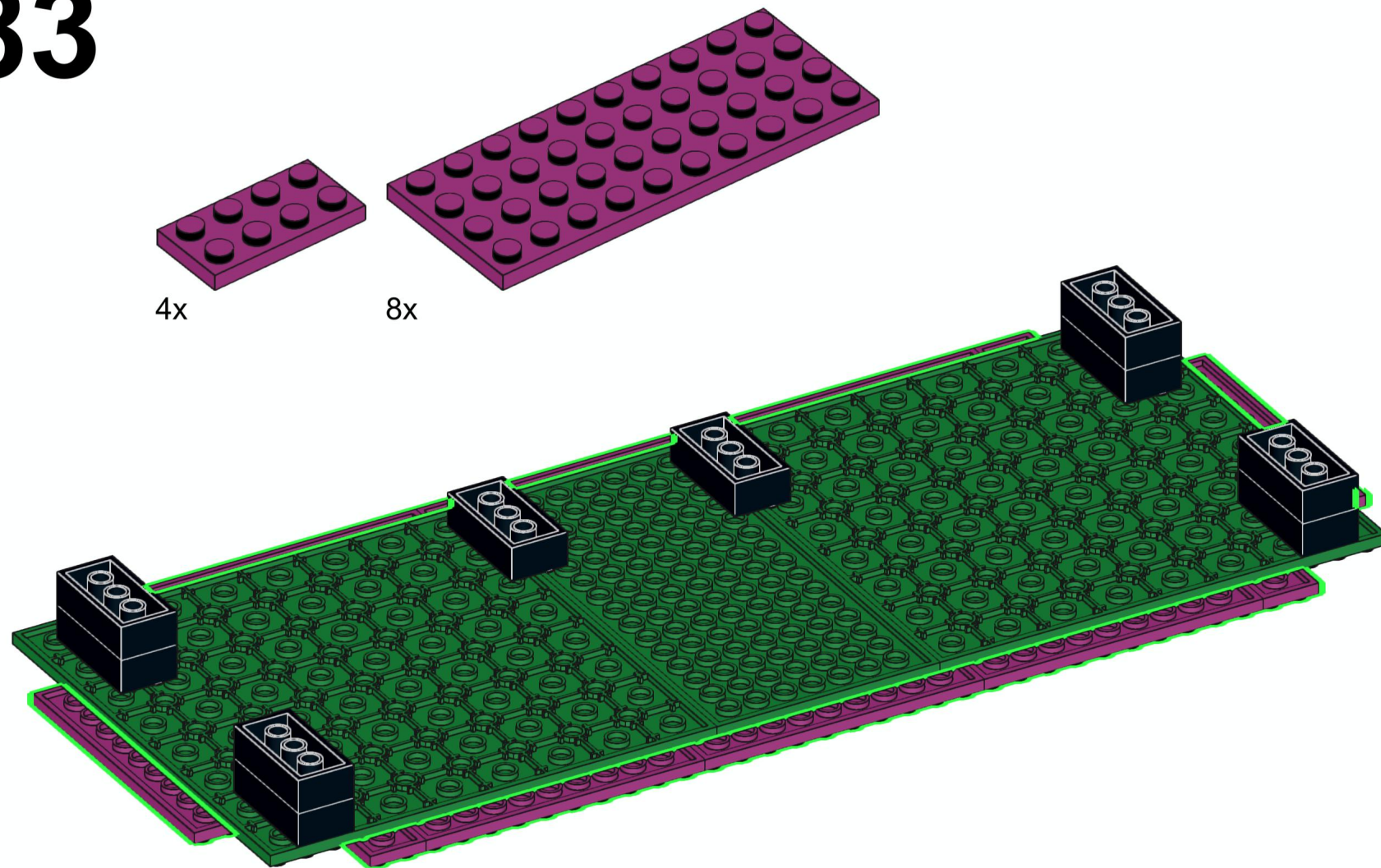

# 384

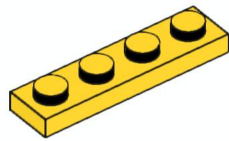

1x

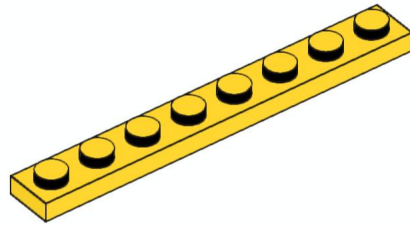

4x

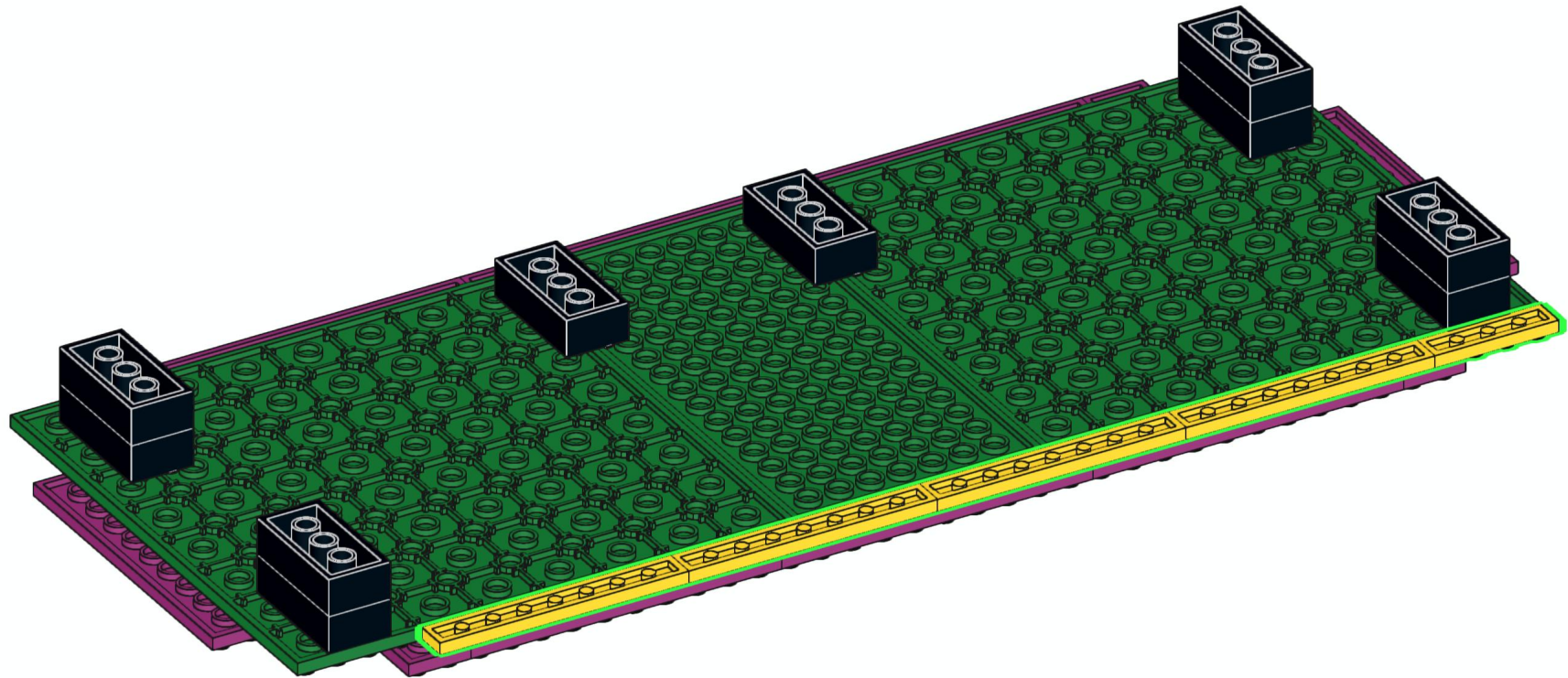

# 385

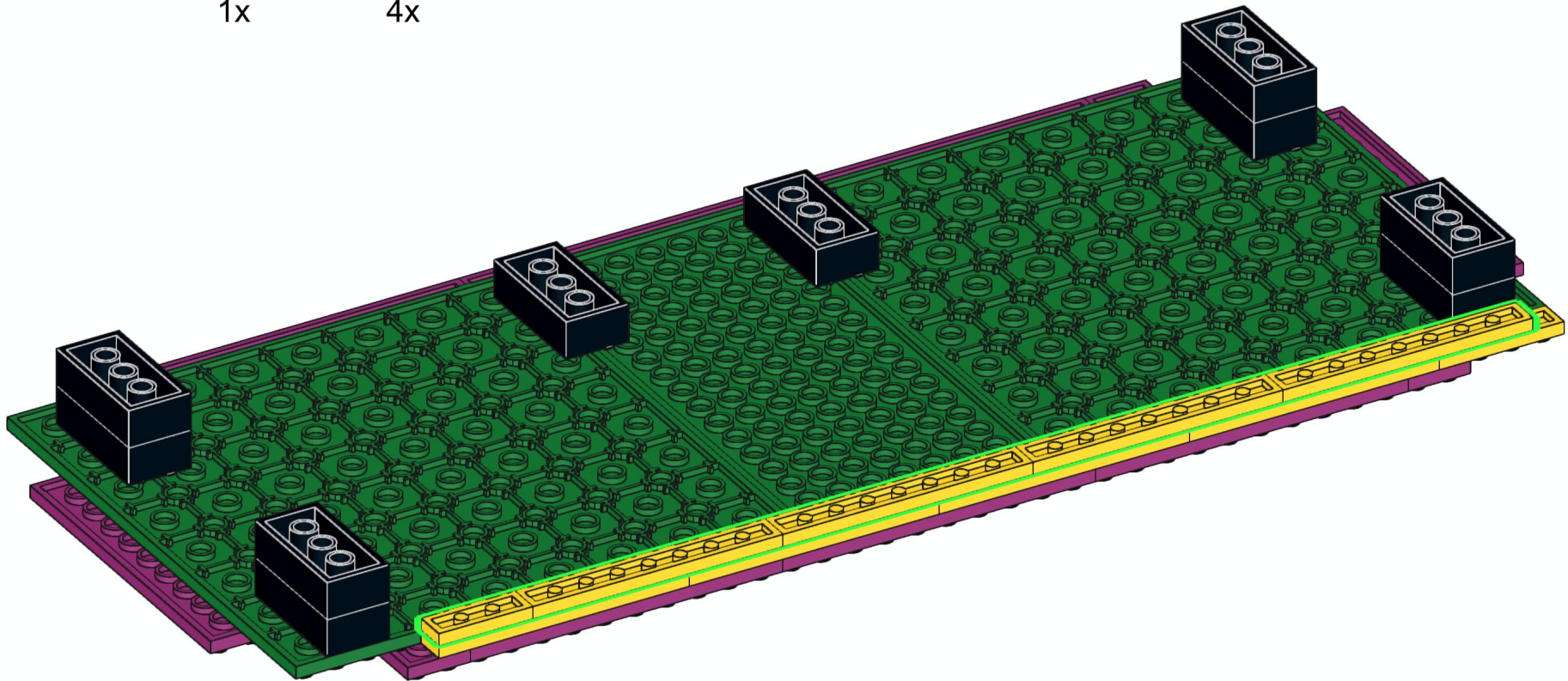
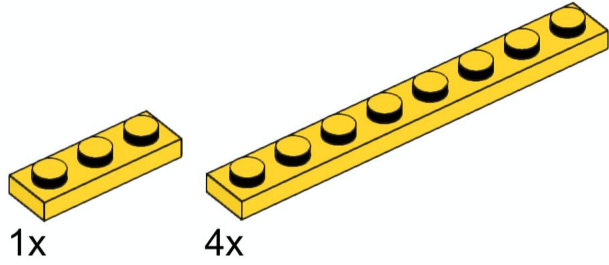

# 386

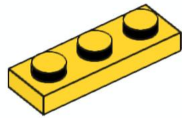

1x

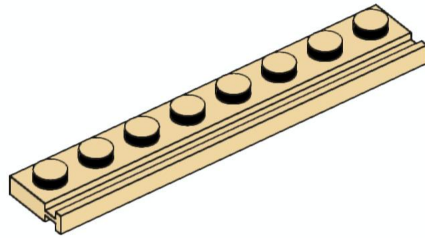

4x

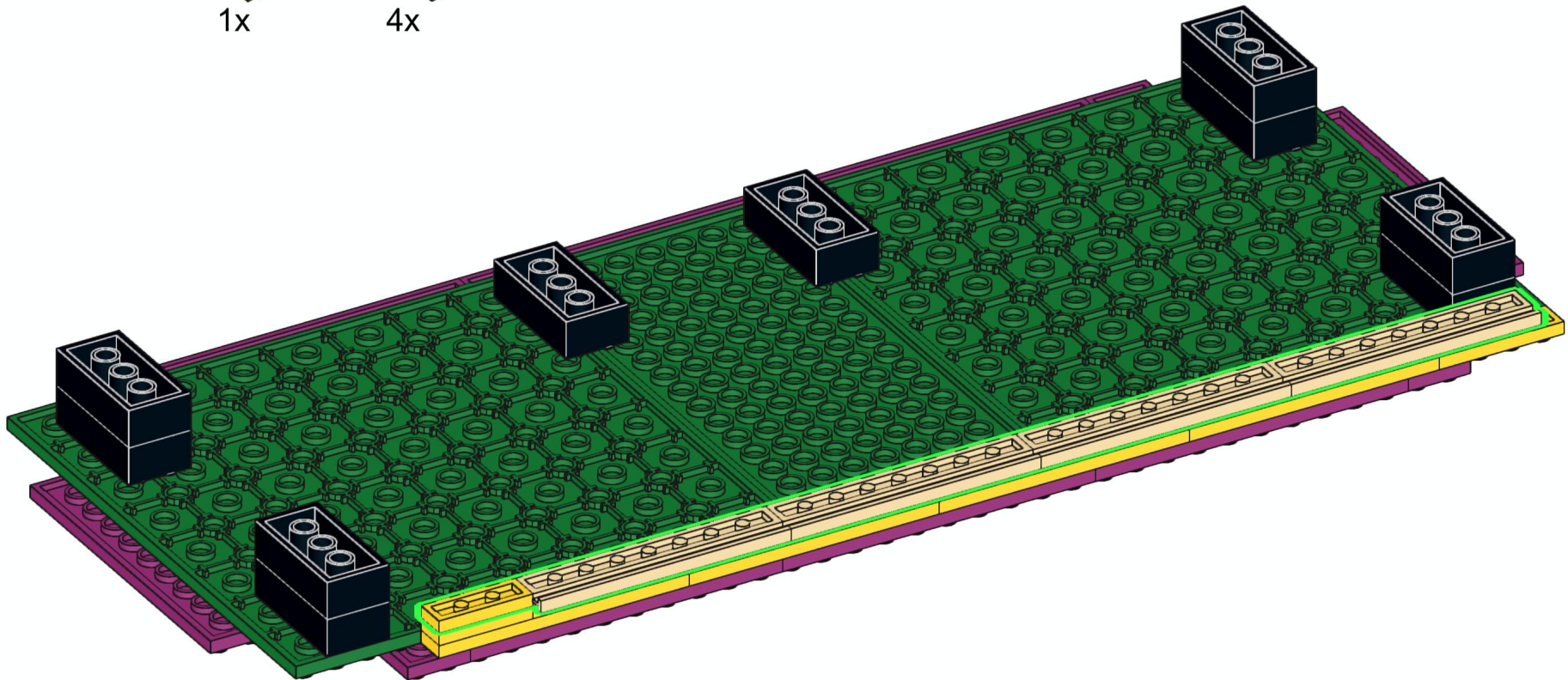

# 387

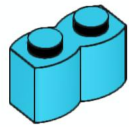

18x

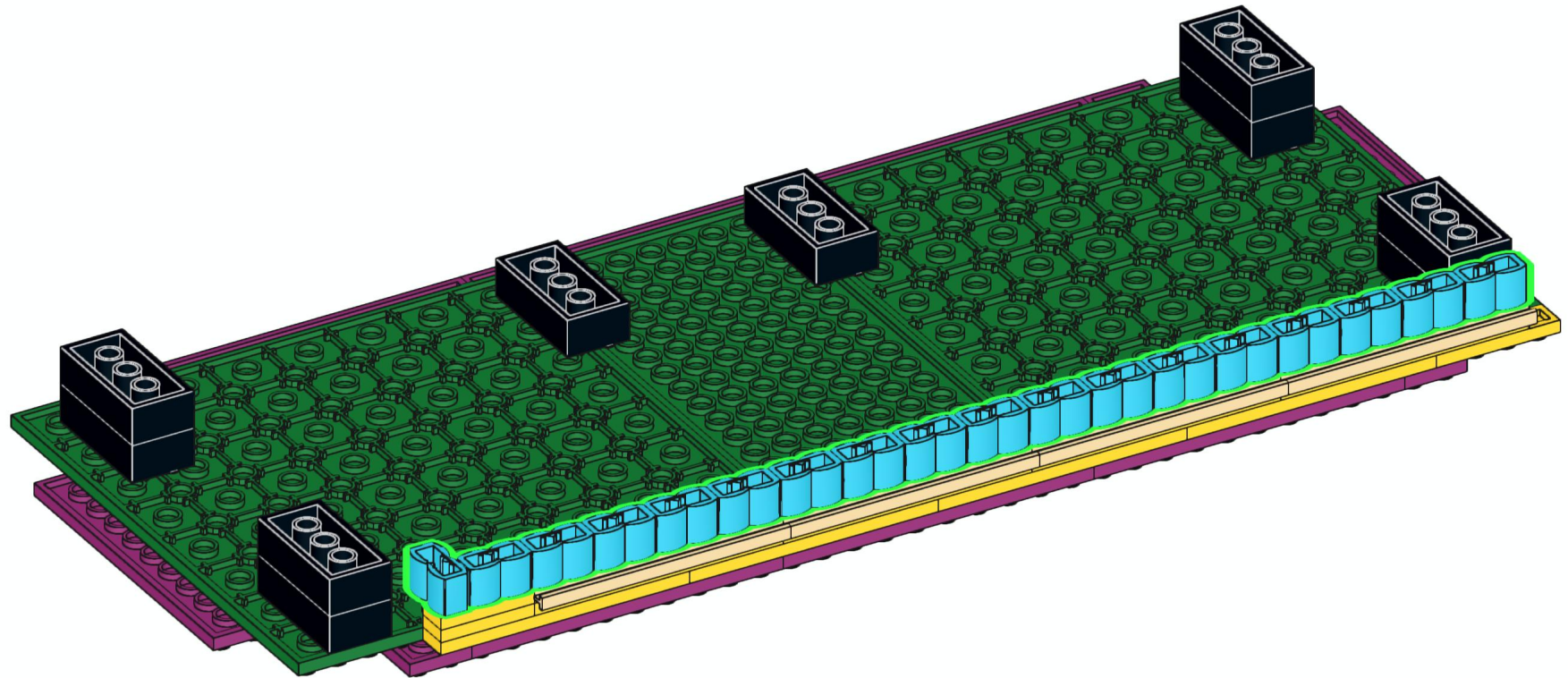

# 388

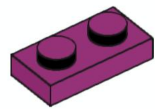

2x

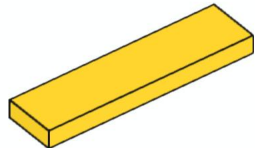

1x

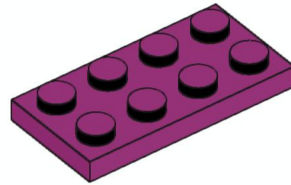

8x

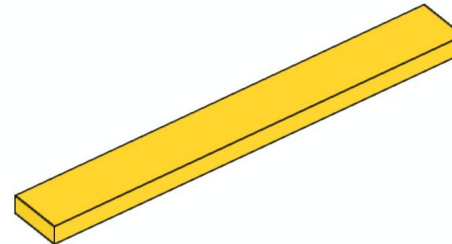

4x

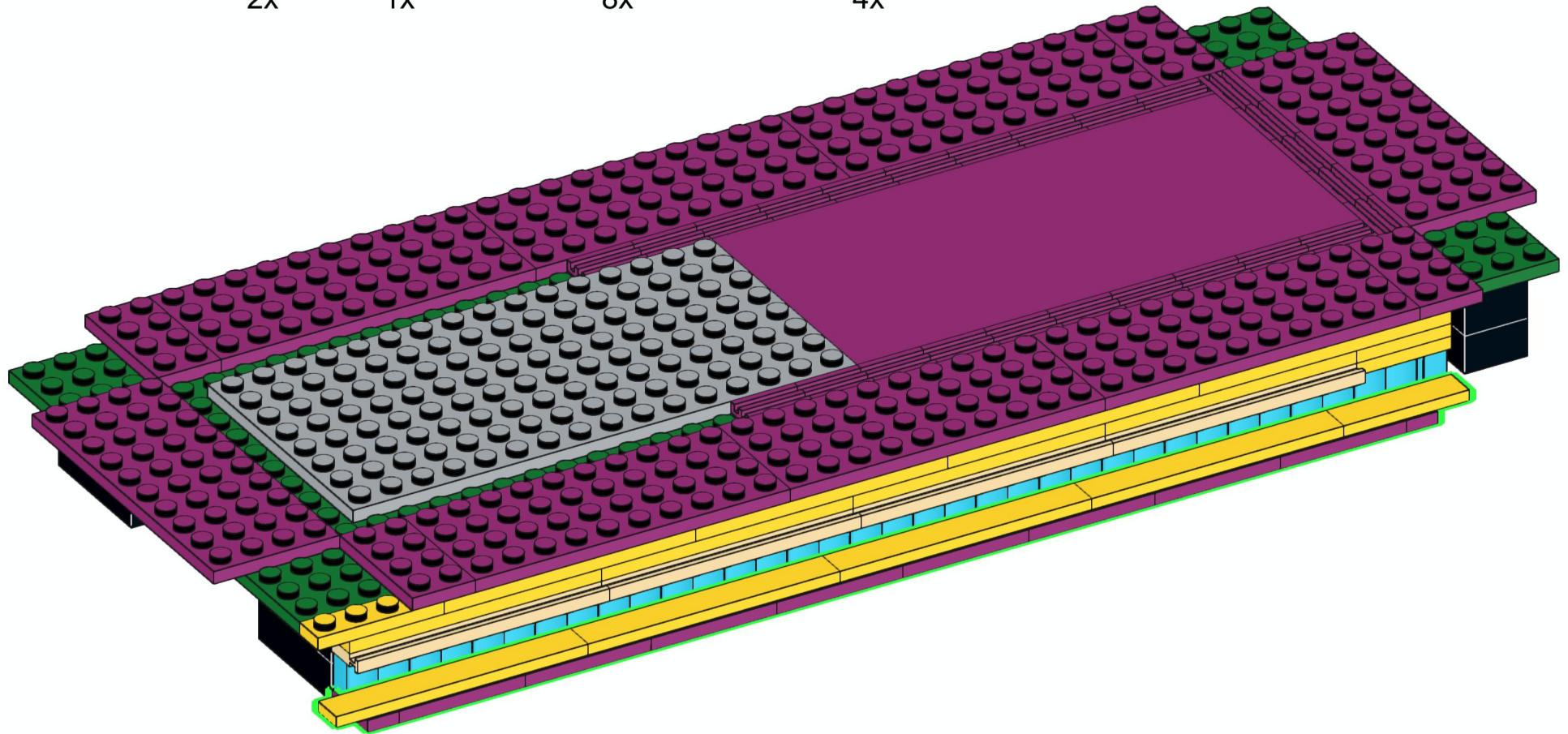



# 389

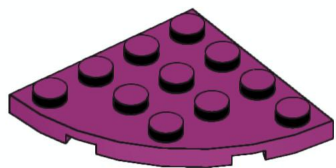

4x

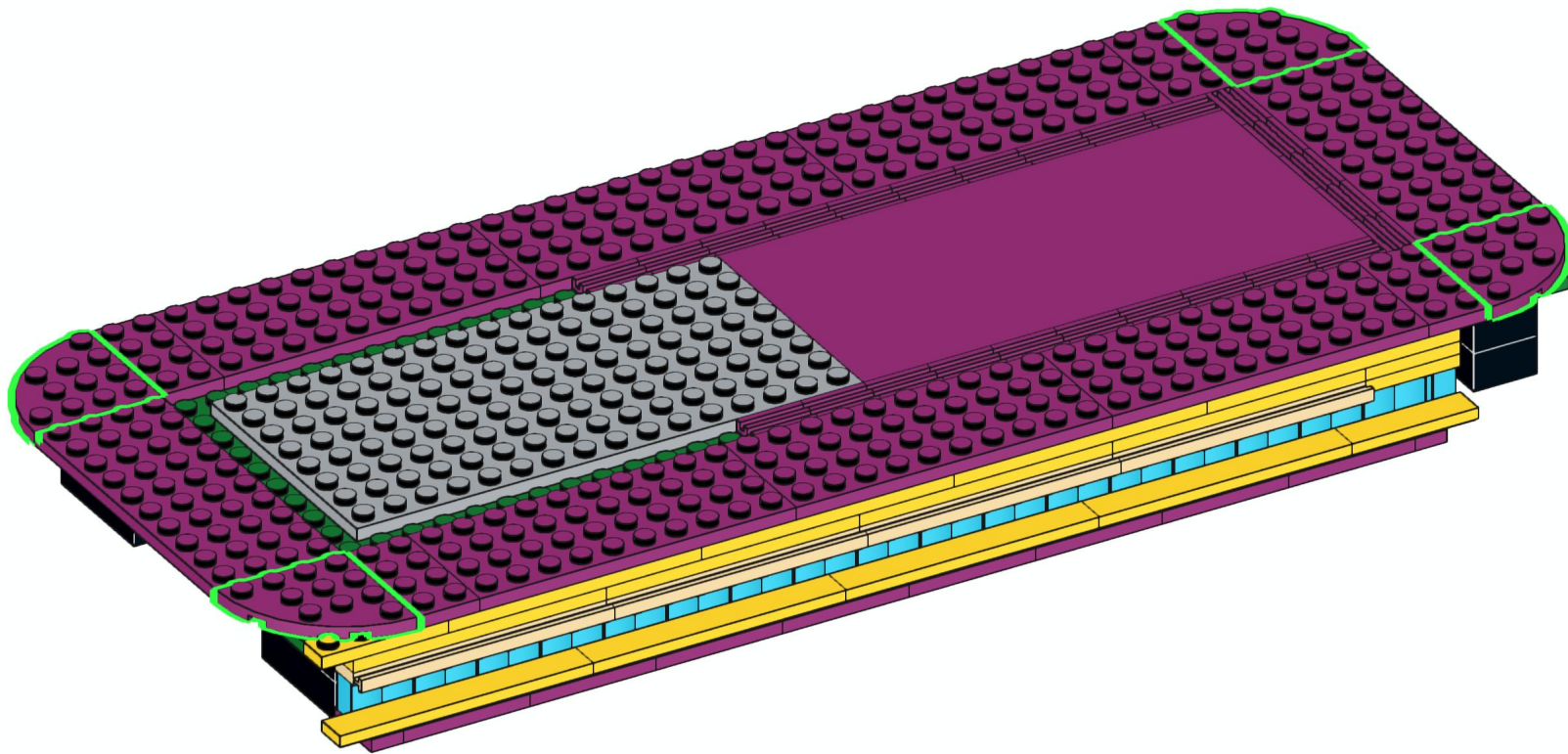

# 390

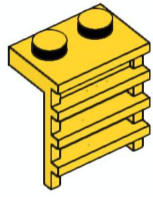

2x

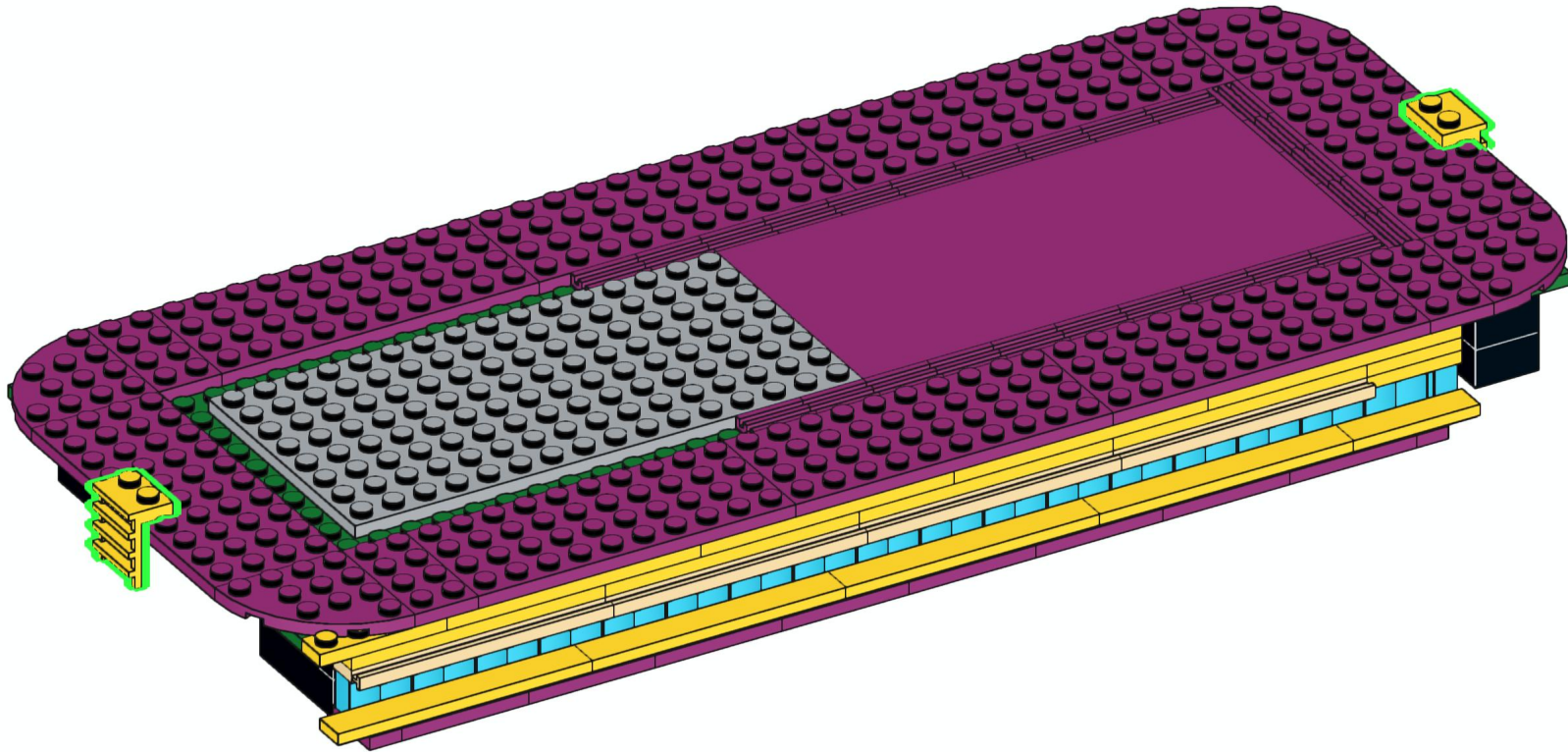

# 391

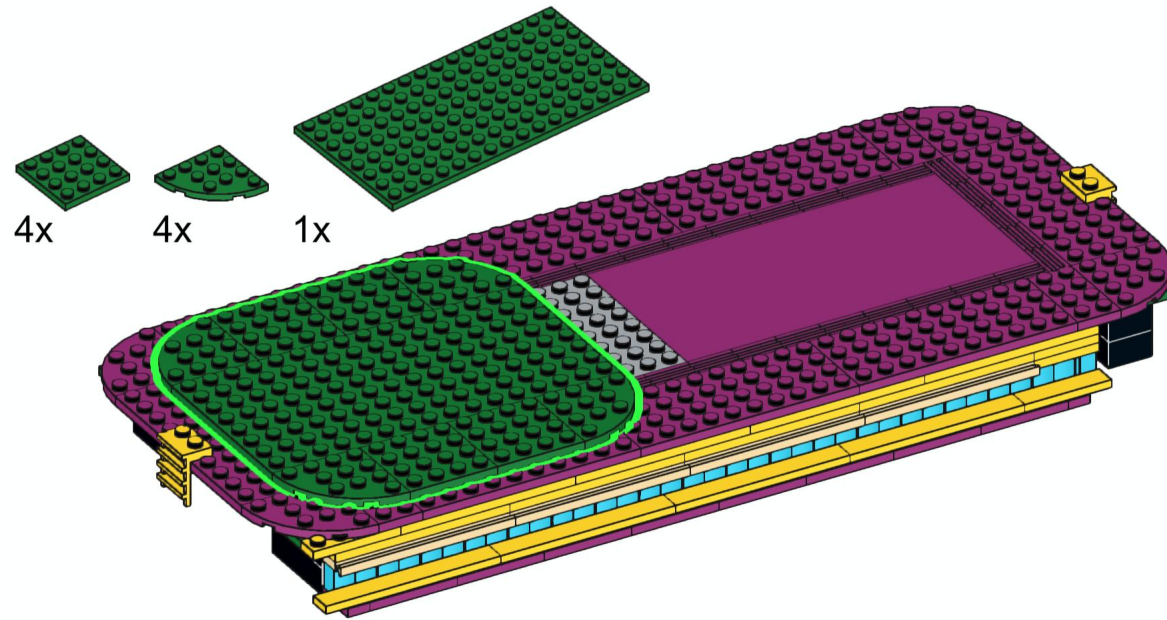

# 392

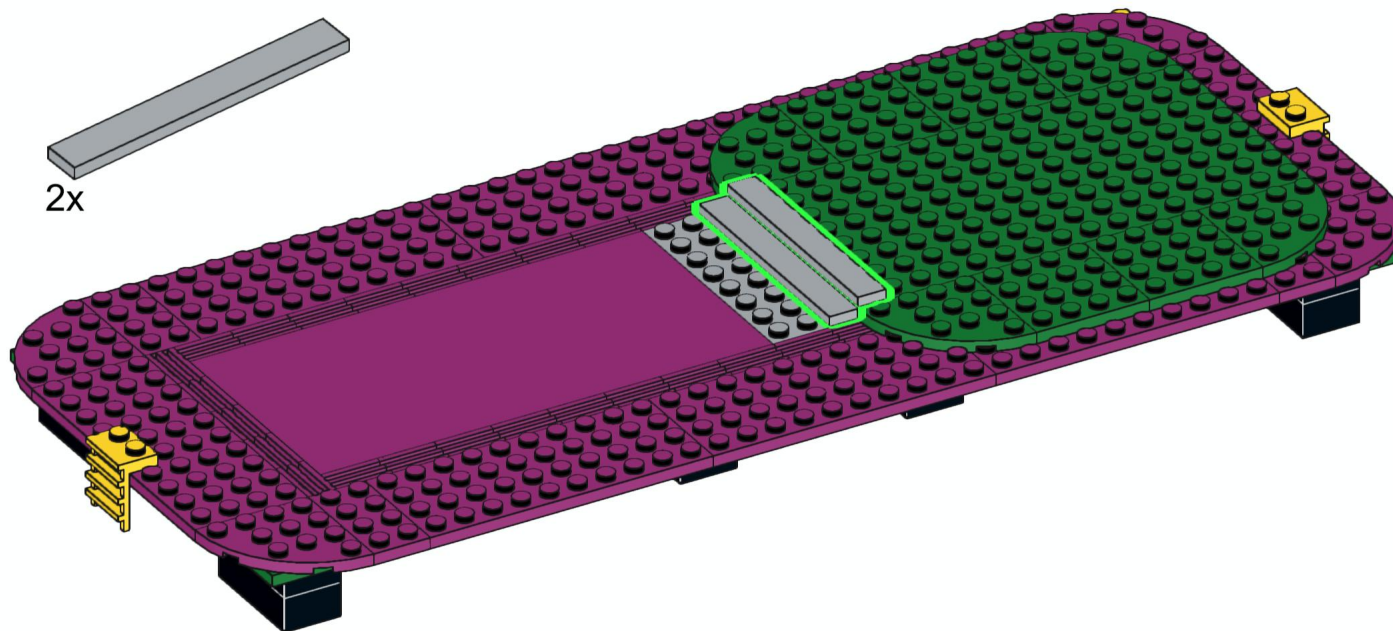

# 393

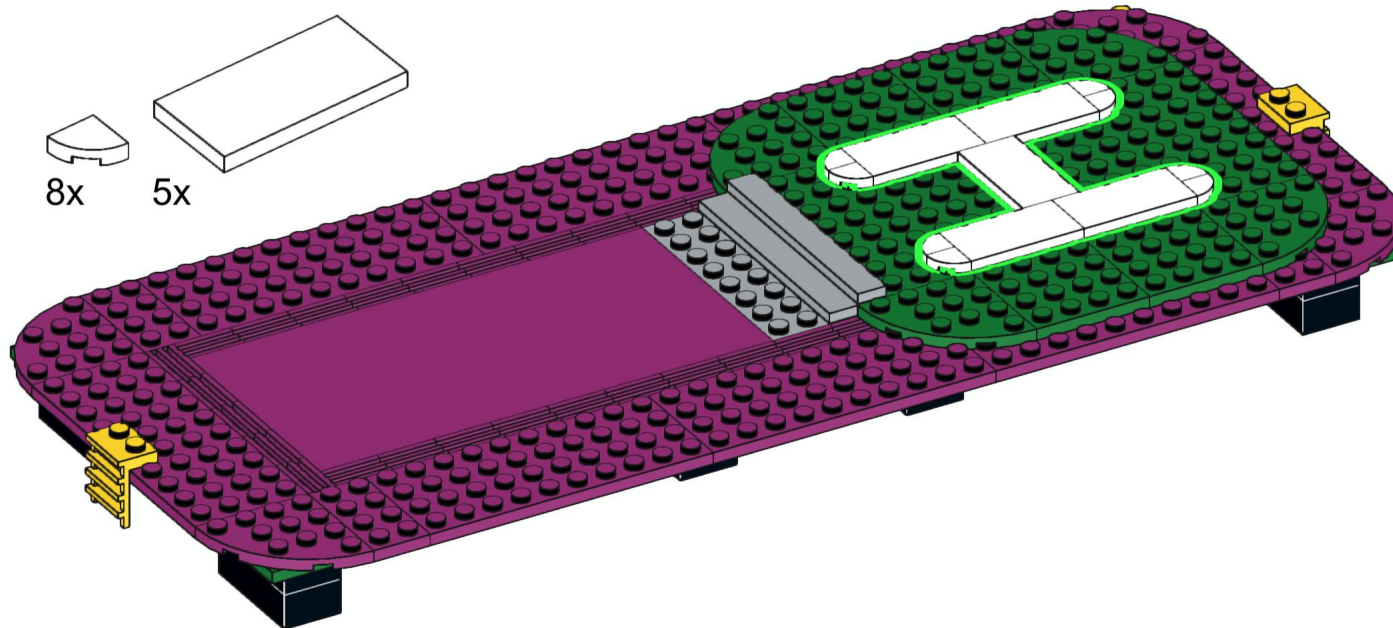

# 394

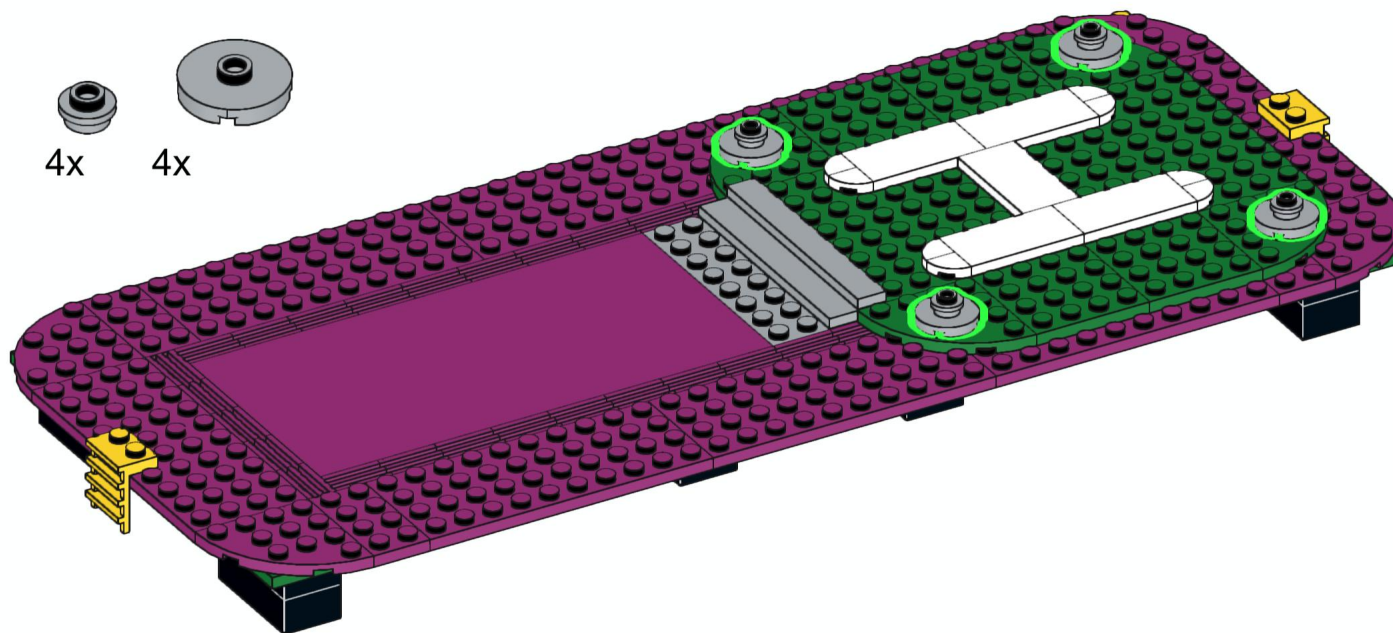

# 395



4x

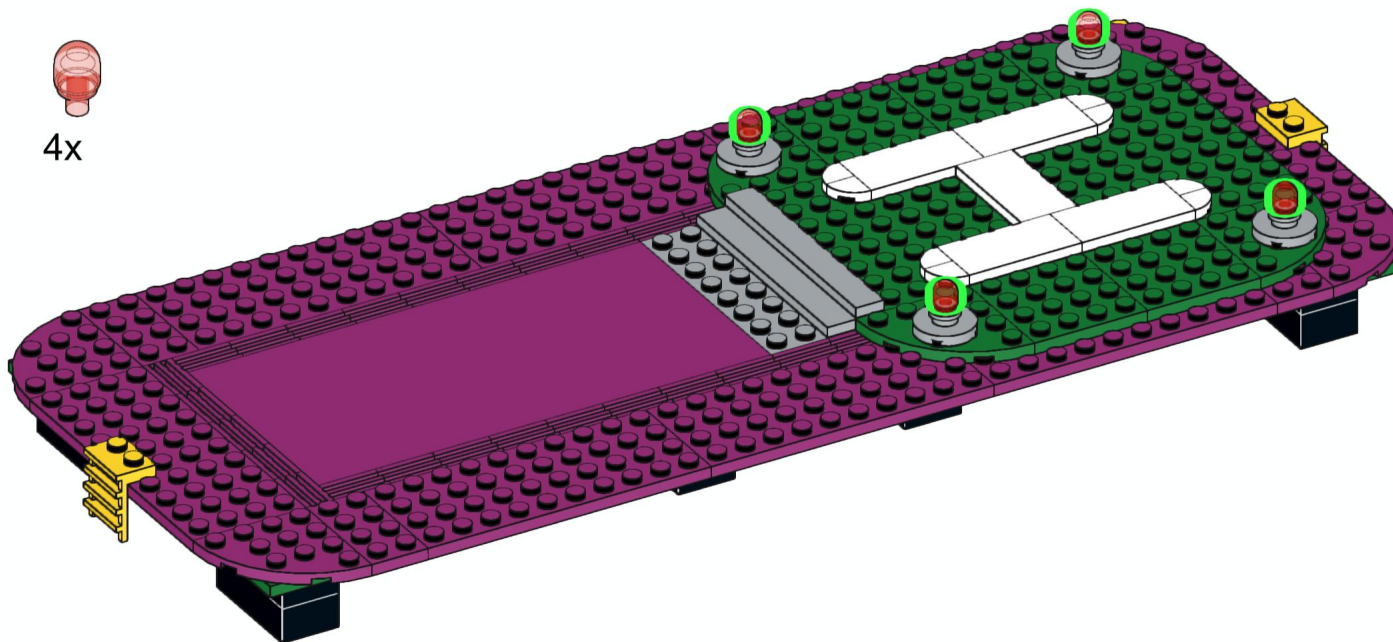

# 396

28x

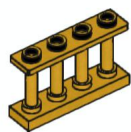

21x

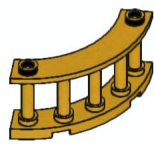

4x

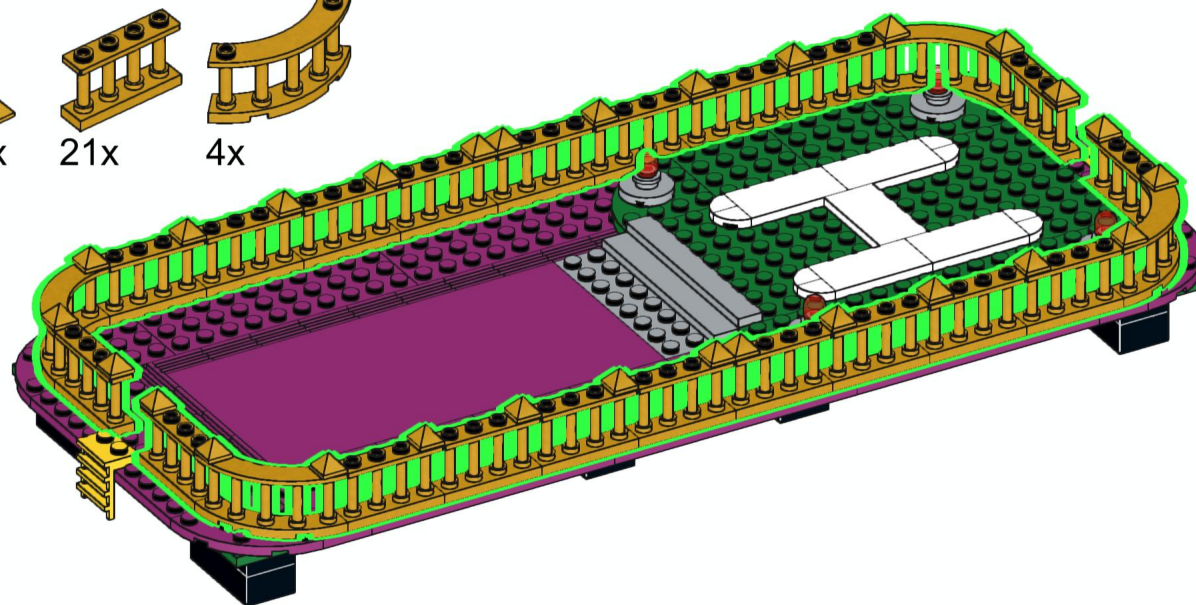

397

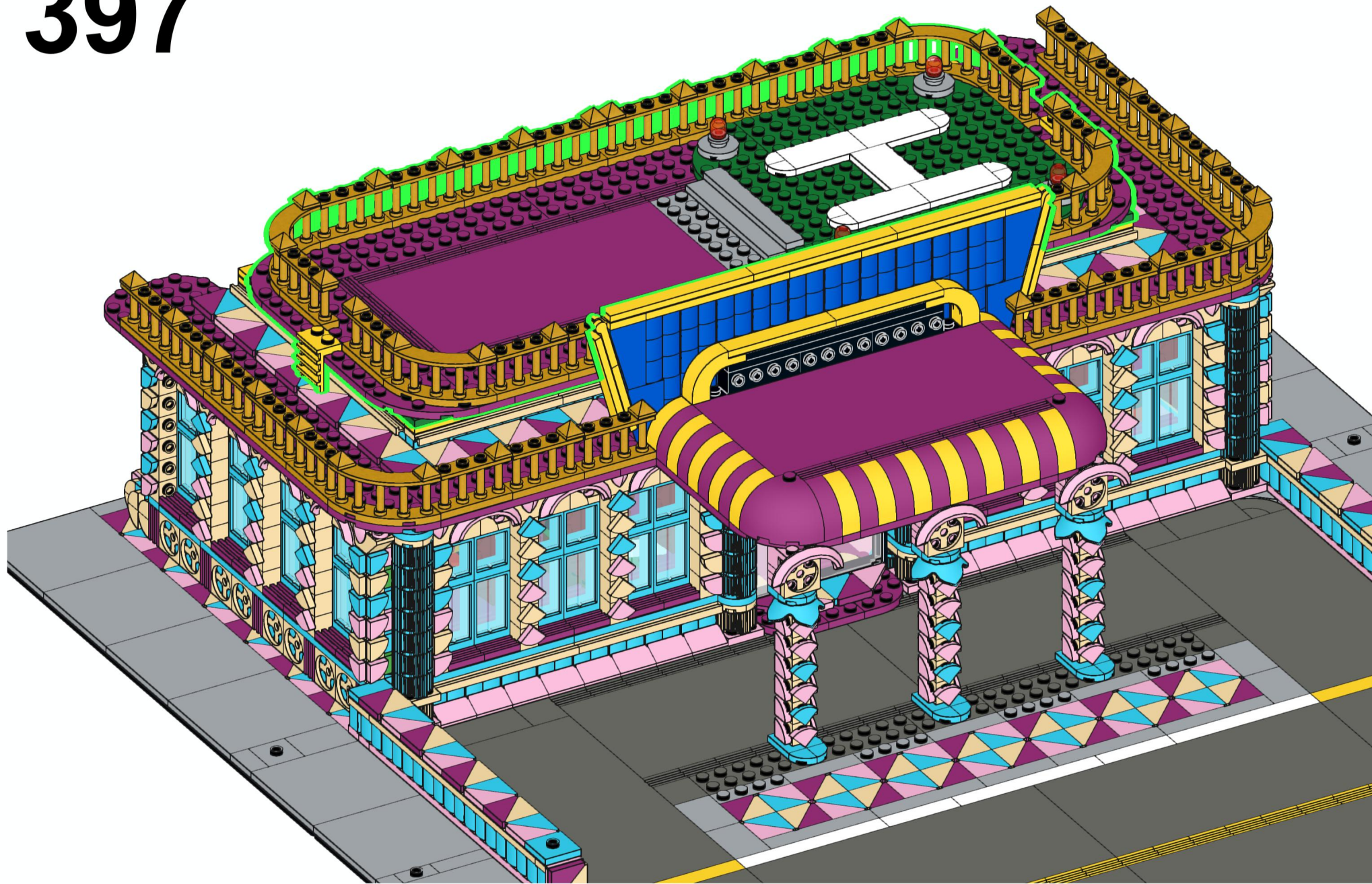

# 398



2x

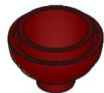

2x

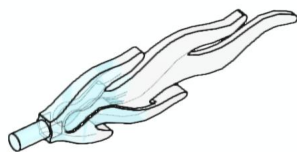

2x

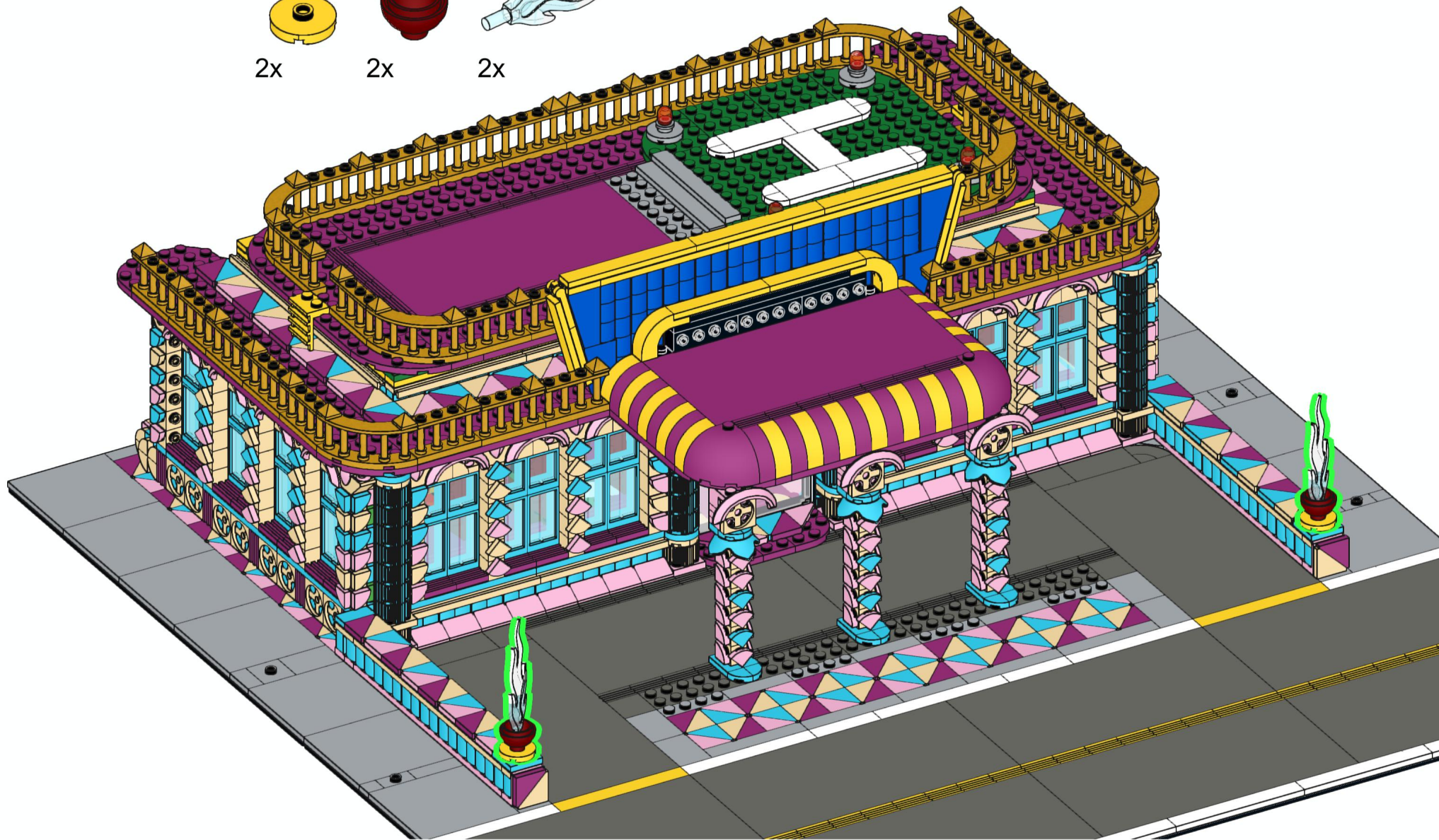

# 399

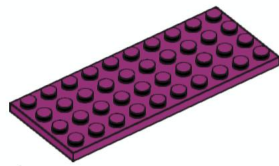

1x

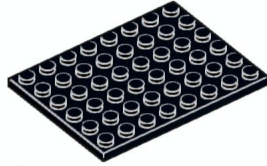

1x

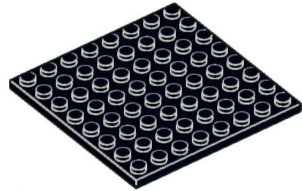

1x

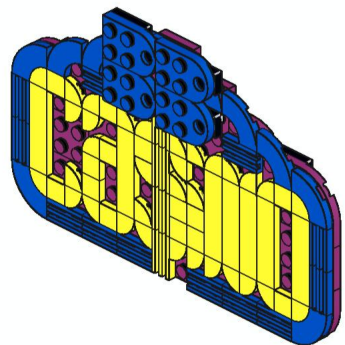
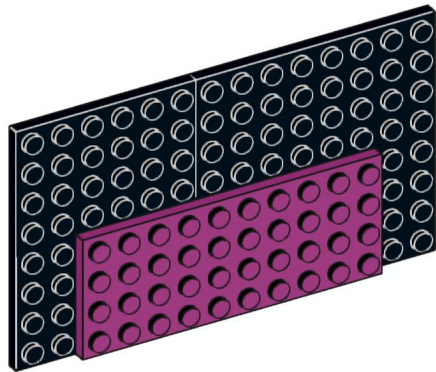

# 400

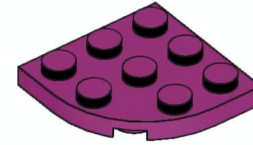

6x

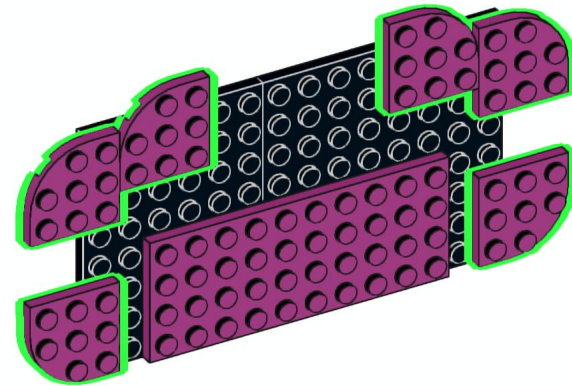



# 401

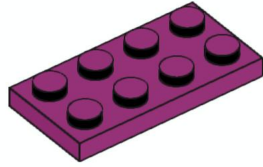

7x

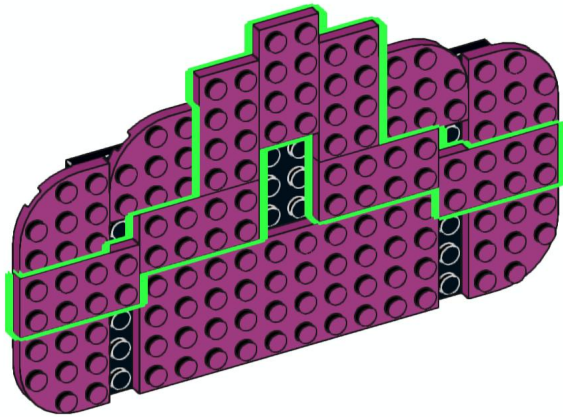

# 402



14x

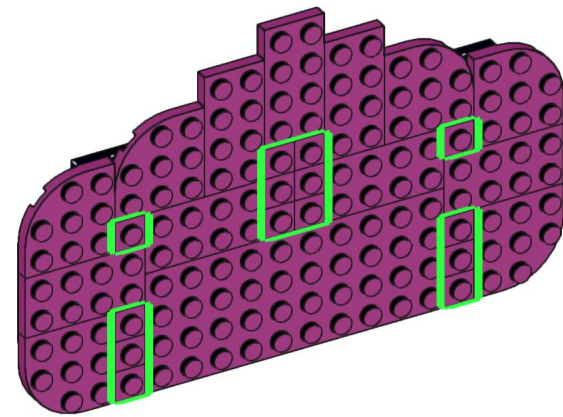

# 403

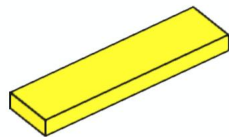

7x

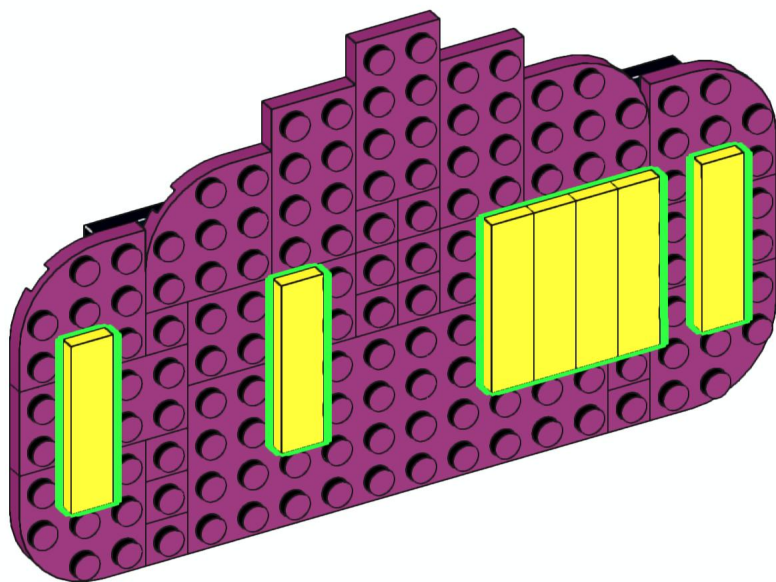

# 404



8x

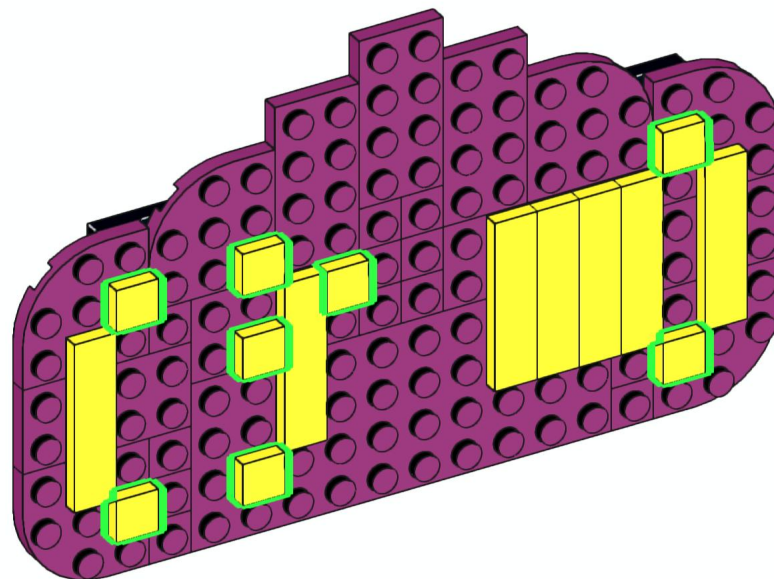

# 405

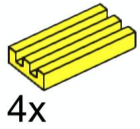

4x

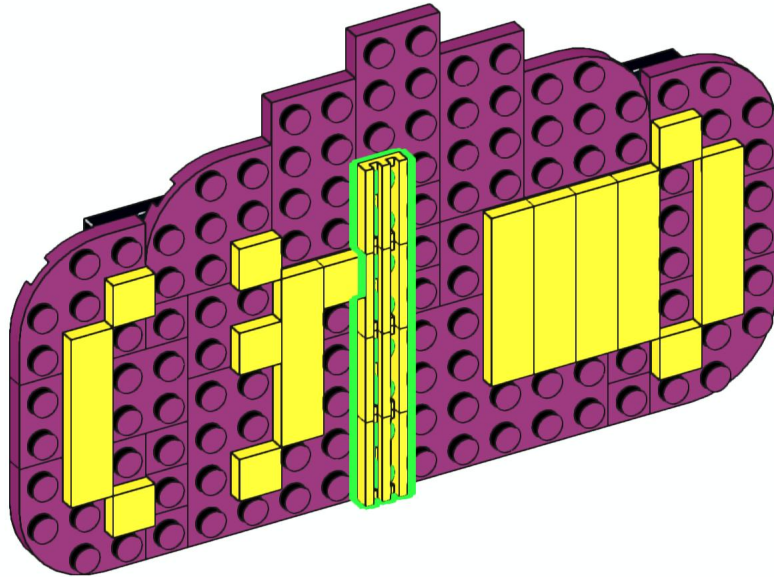

# 406



32x

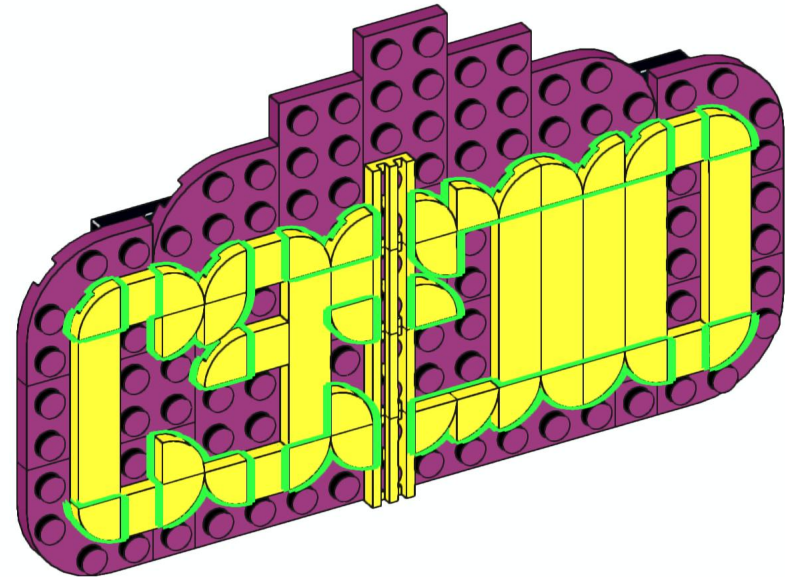

# 407

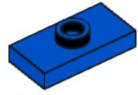

1x

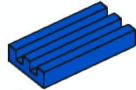

12x

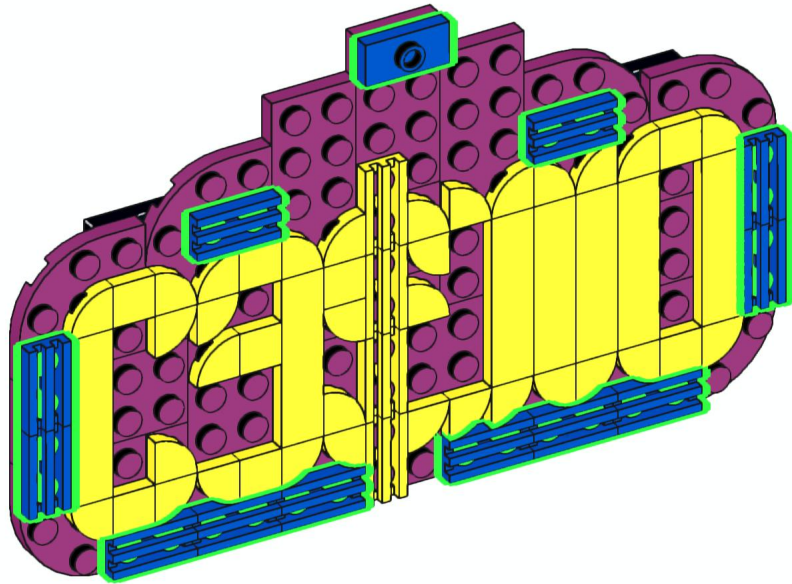

# 408



10x

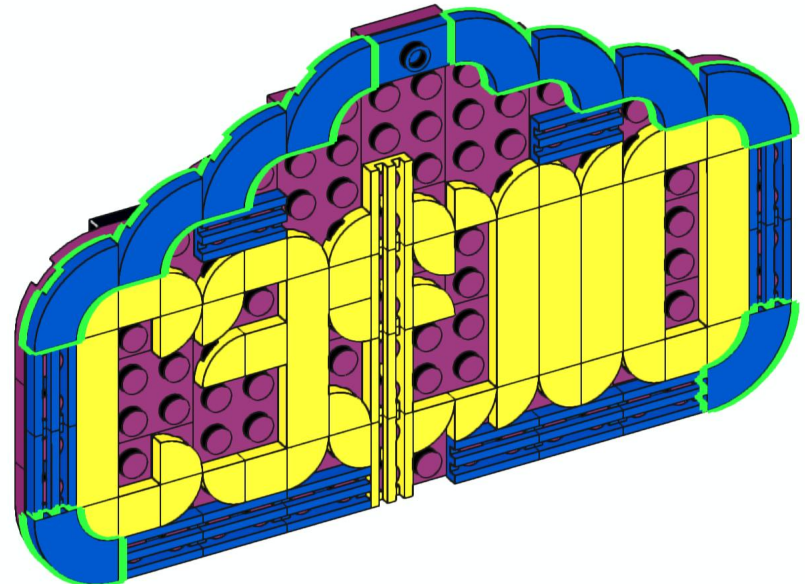

# 409

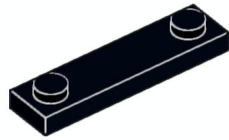

2x



4x



1x

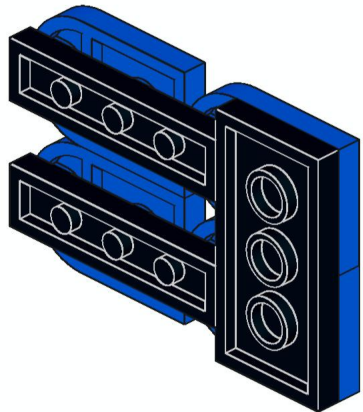
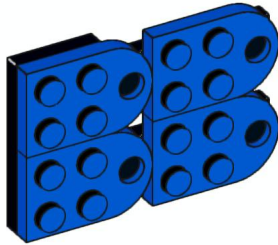

# 410



6x



1x

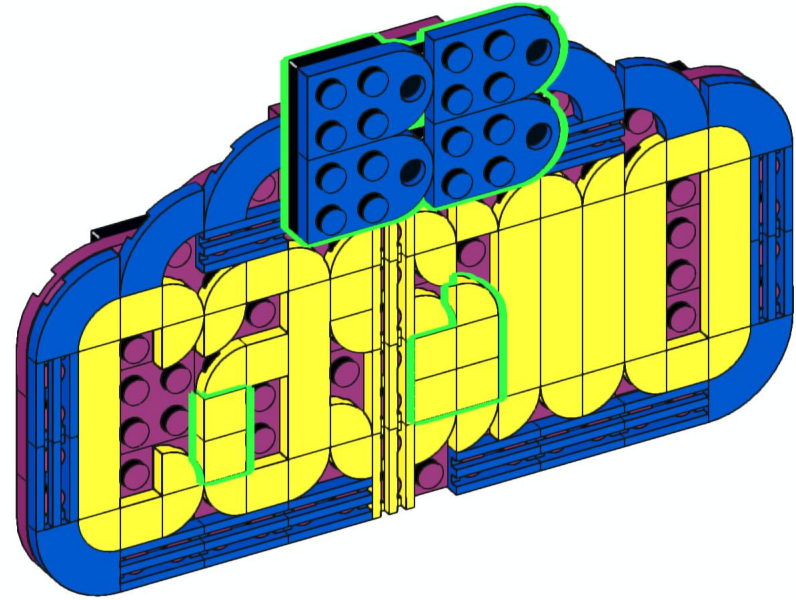

411



# 412

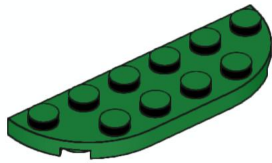

8x



# 413

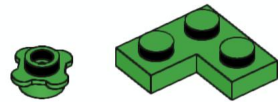

8x

8x





# 414



16x



# 415



8x







# 416



4x



# 417

- 1x 
- 1x 
- 1x 
- 1x 



# 418



1x



9x



# 419



1x



1x



# 420



3x



# 421

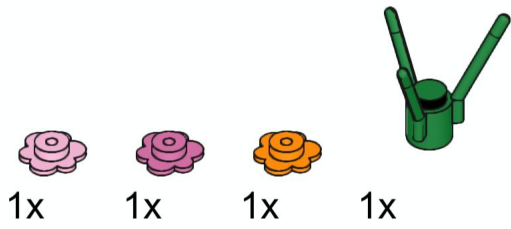



# 422

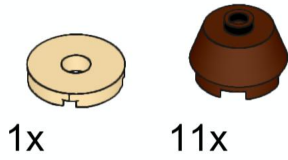

# 423



1x



1x

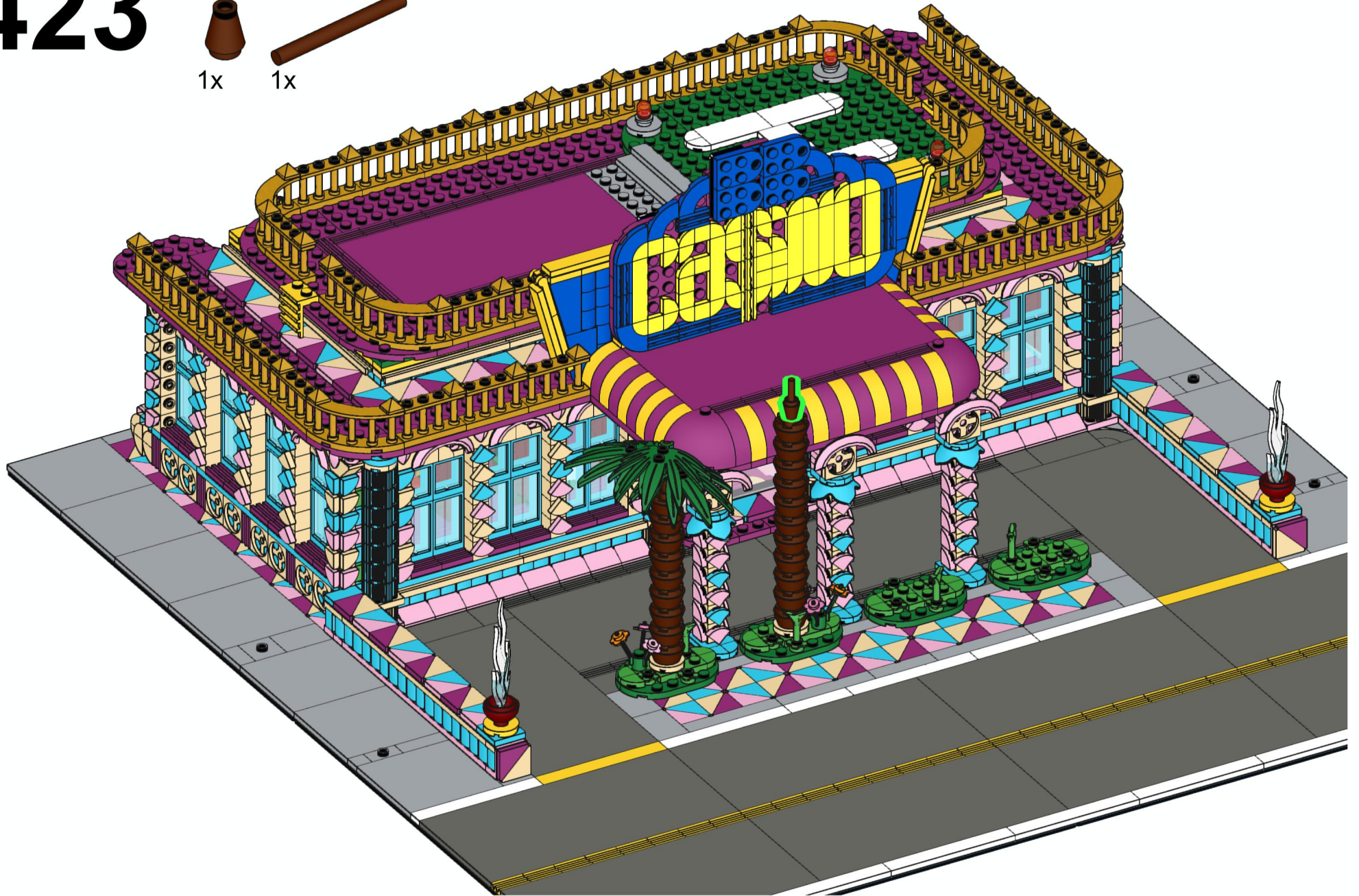

# 424



3x



# 425



1x



1x



1x



1x



# 426



1x



11x



# 427



1x



1x



# 428



3x



# 429

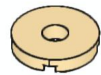

1x



9x





# 430



1x



1x







# 431



3x



# 432

- 1x 
- 1x 
- 1x 
- 1x 



# 433

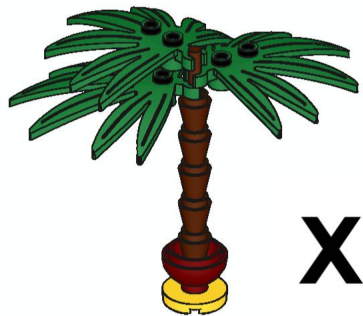
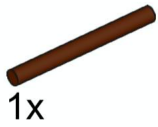
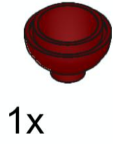
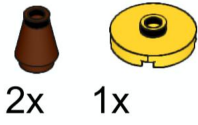

# X4

# 434

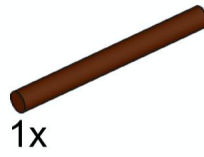

# 435



3x



436



437







2x

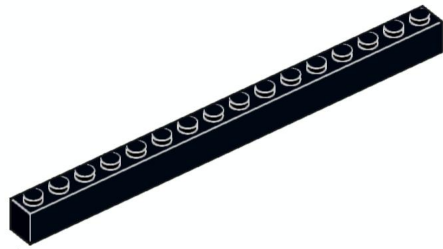

1x

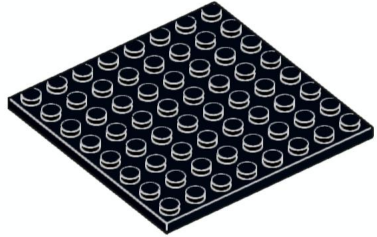

4x



1x



1x

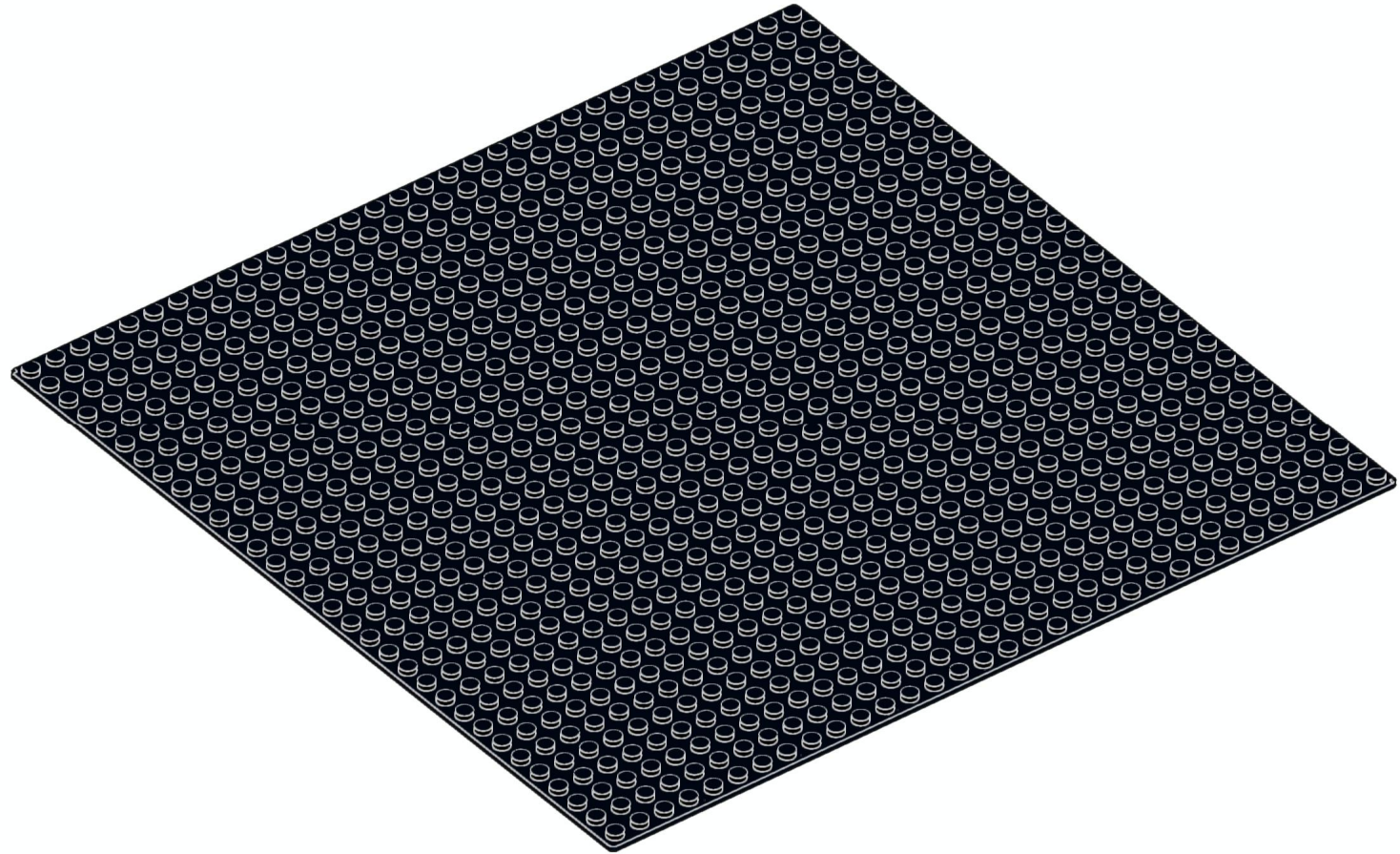

4x





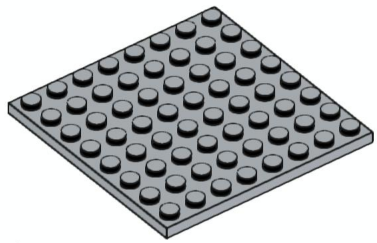

1x

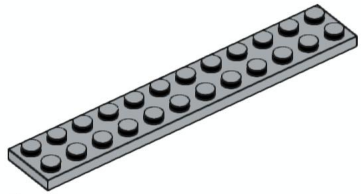

1x

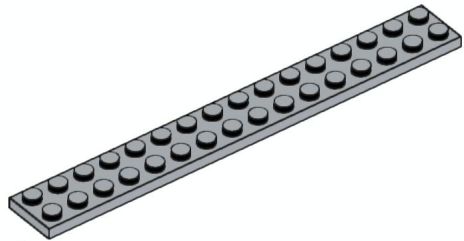

4x

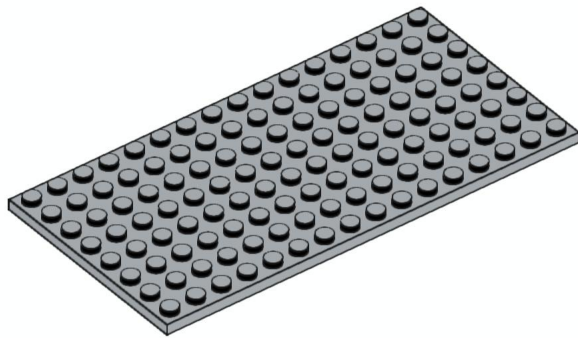

1x



8x



3x



12x



3x



4x



3x



1x



1x



2x



2x



1x



3x



2x



1x



2x

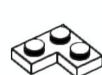

3x



2x



4x



5x



1x



1x



1x

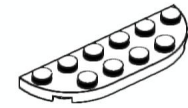

2x

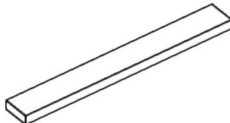

12x



24x



2x



22x



12x



12x



24x



8x



12x



12x



1x



4x



122x



4x



4x



58x



4x



18x



7x



39x



4x



91x



14x



2x



53x



4x



17x





1x



17x



3x

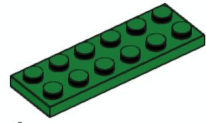

1x



1x

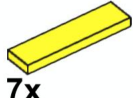

7x

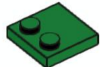

6x

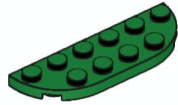

8x

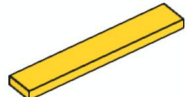

4x



1x



4x



30x

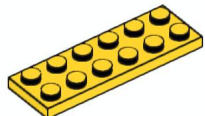

1x



9x

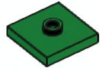

1x

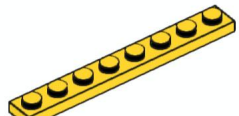

10x



9x



4x

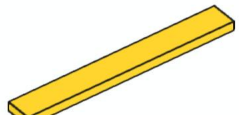

18x



2x



4x

58x



1x



6x

14x



6x

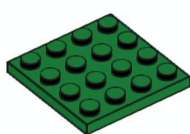

4x



6x



1x

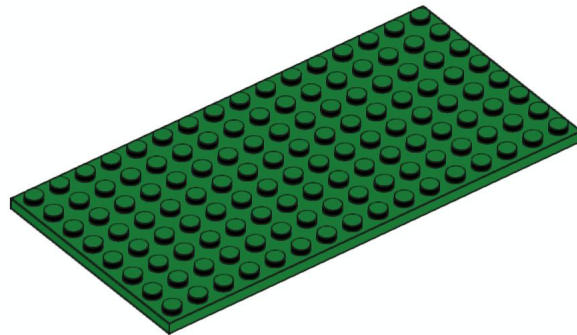
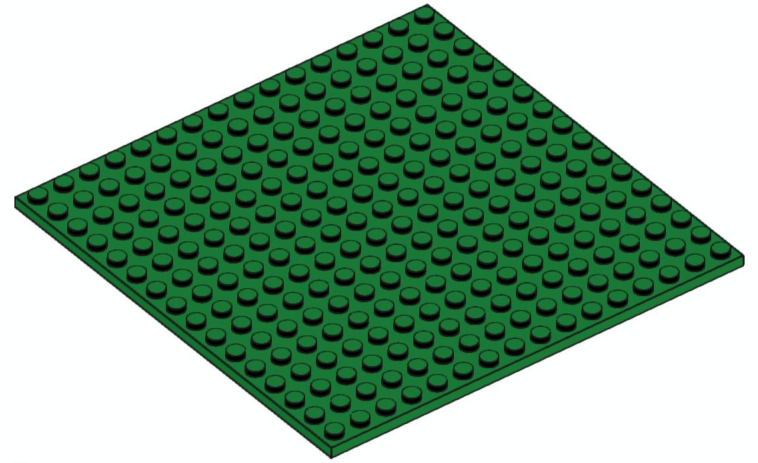

2x



16x



4x



16x



4x



4x



8x



12x

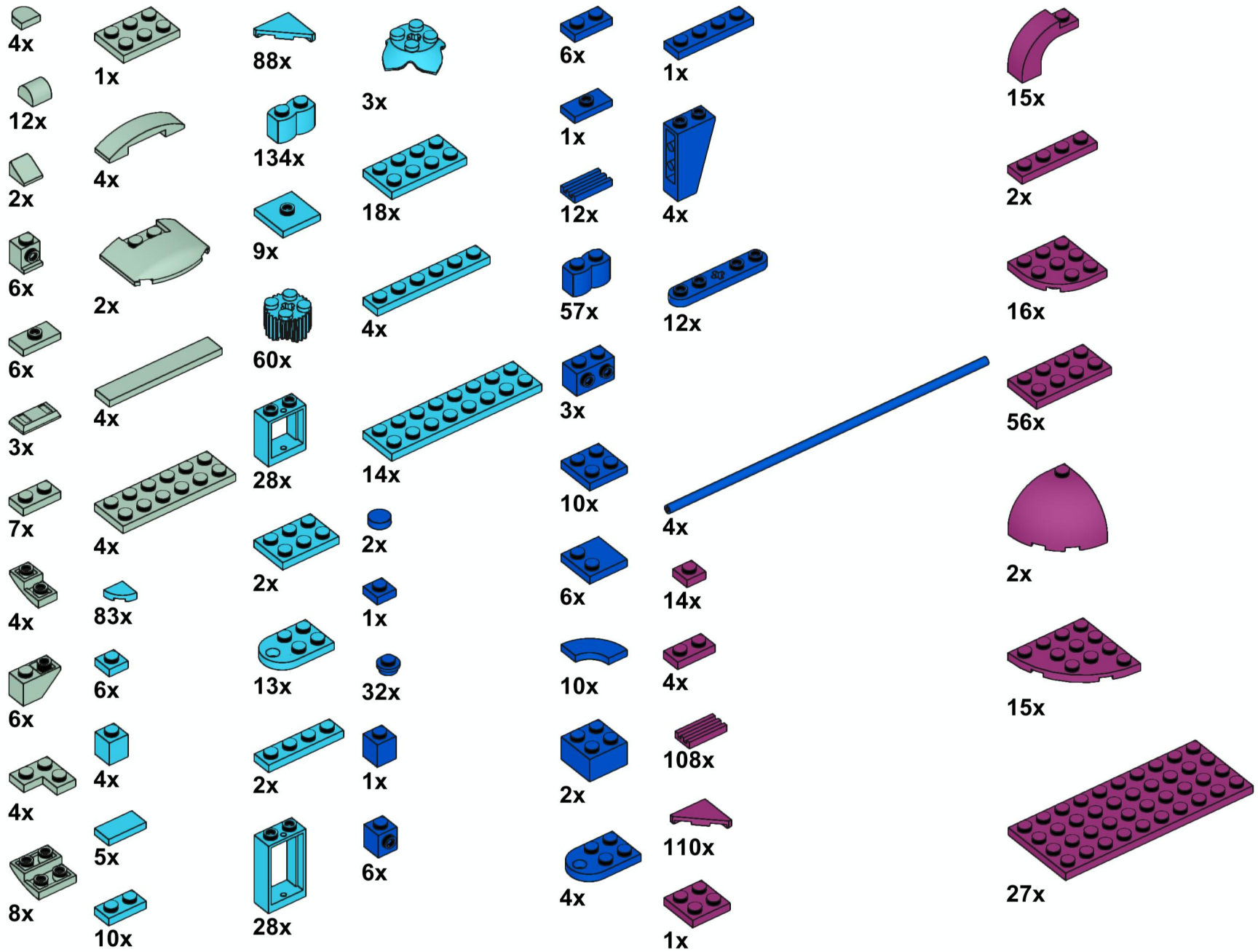

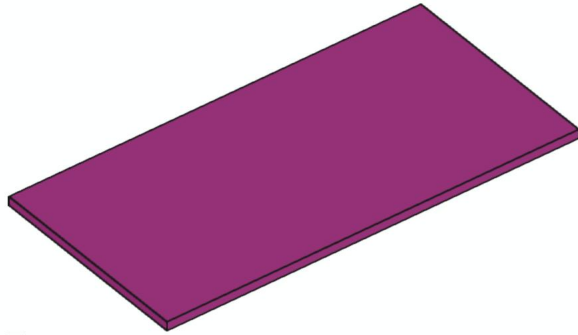

7x



2x



2x



2x



9x



2x



9x



1x

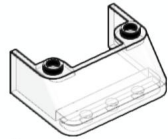

1x



2x

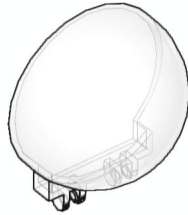

1x



3x



1x



4x



2x



28x



28x



2x



1x



2x



2x



2x



1x



2x



1x

FS



1x



2x



4x



5x



2x



4x



2x



1x



2x



1x



49x



16x



1x



1x



1x



16x



14x



9x



4x



4x



1x



1x



1x

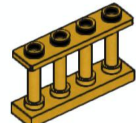

43x

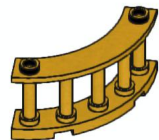

6x



2x