

# Blue Brixx



Design by Marco



# 1

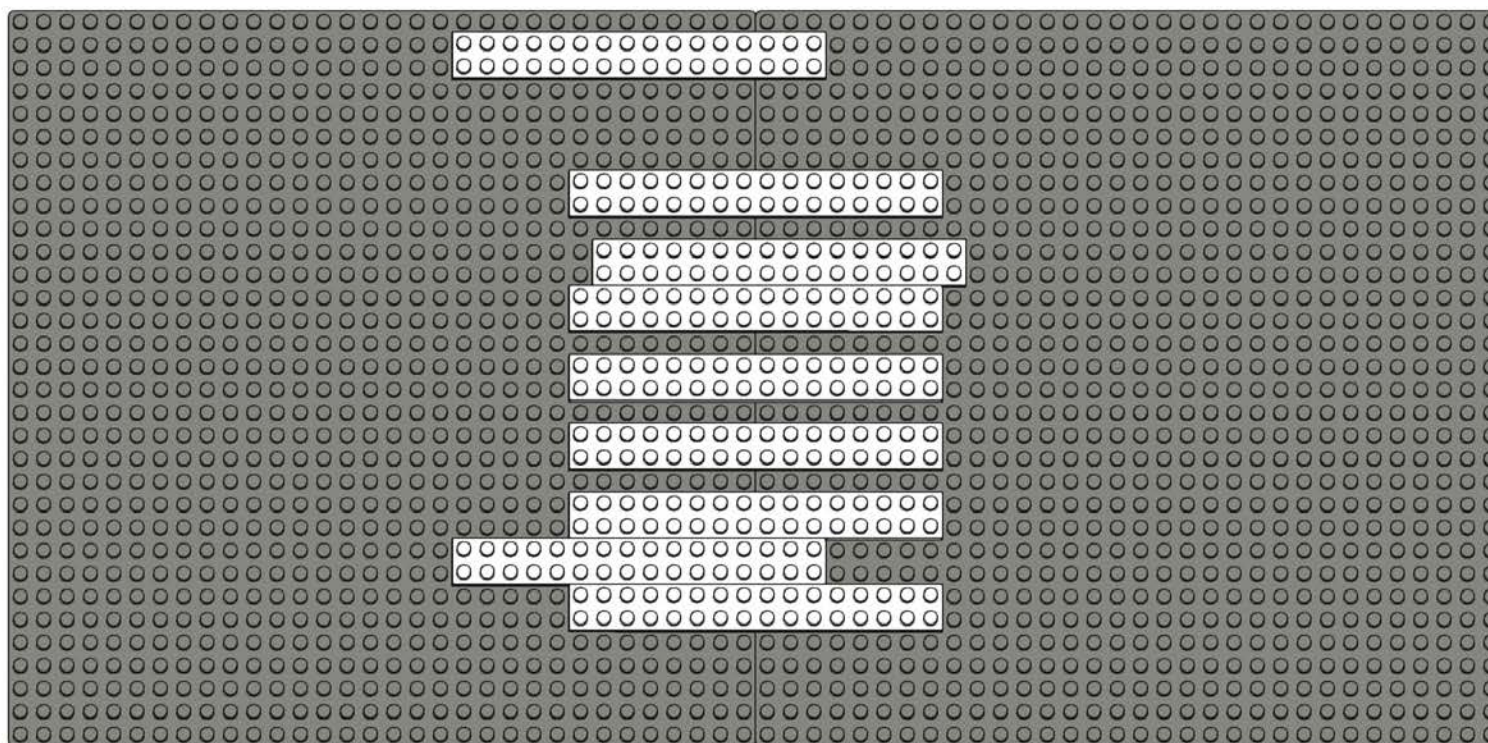
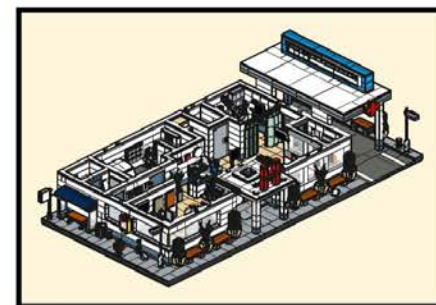
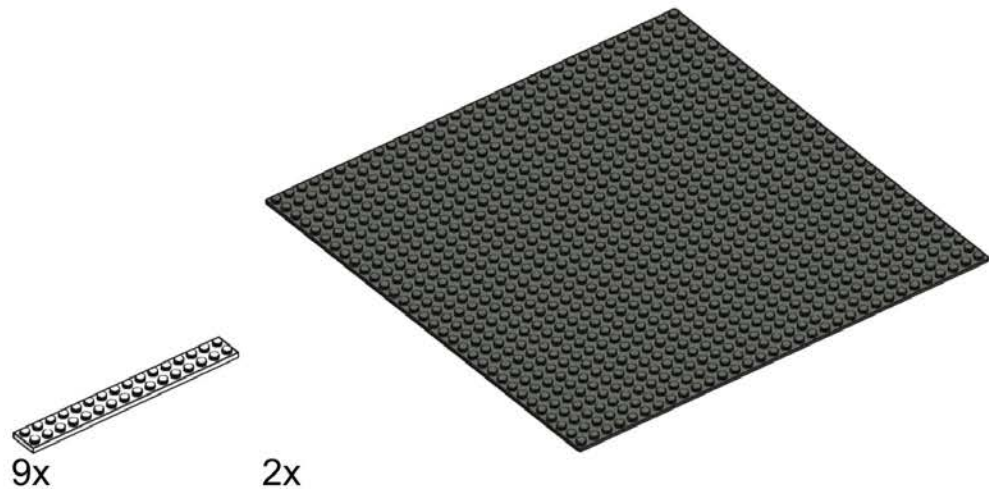



# 3

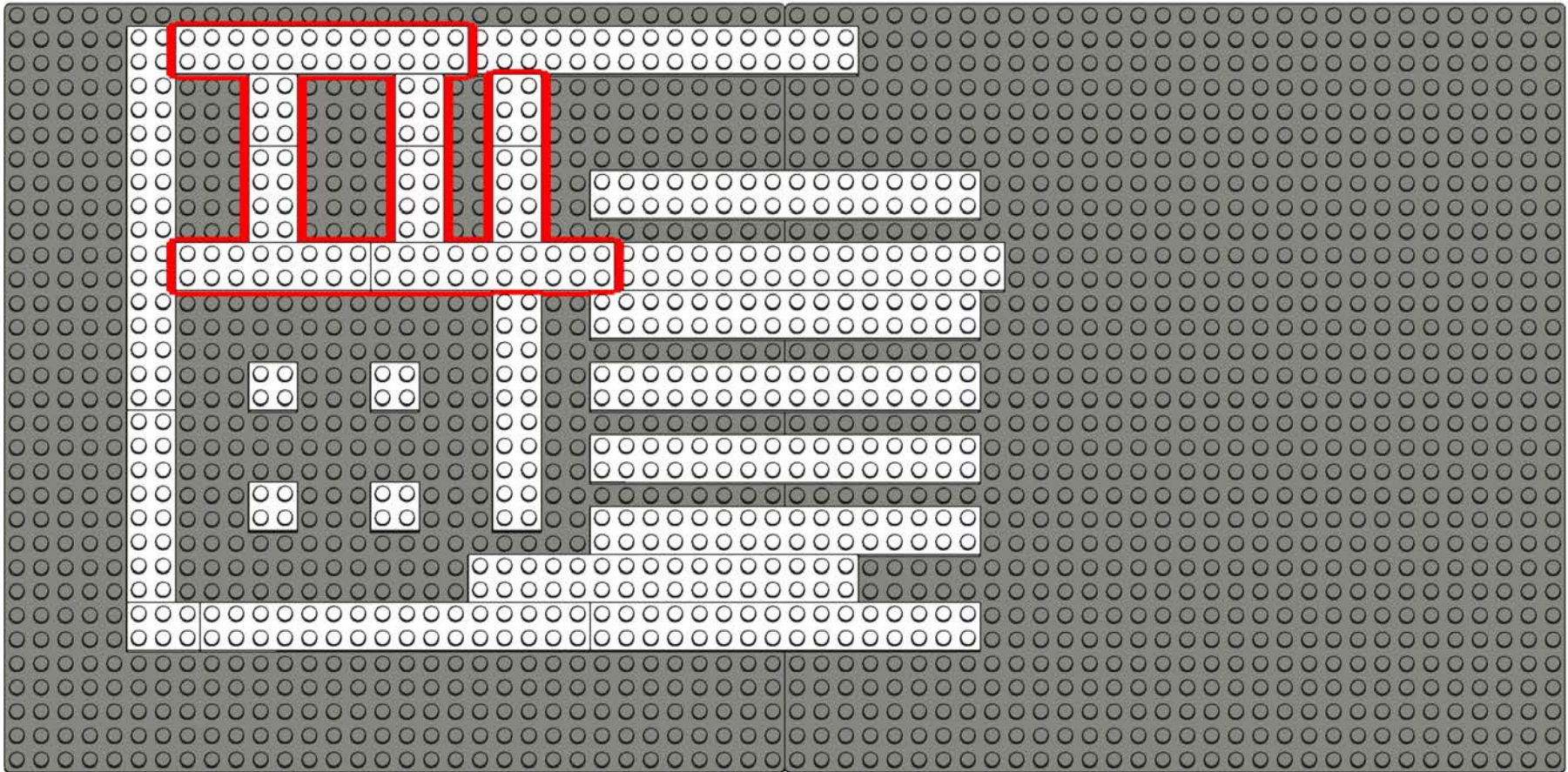
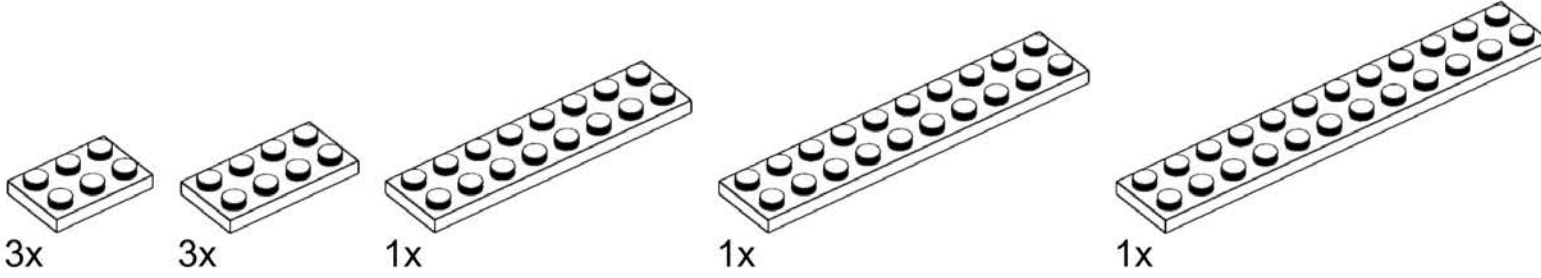

# 4

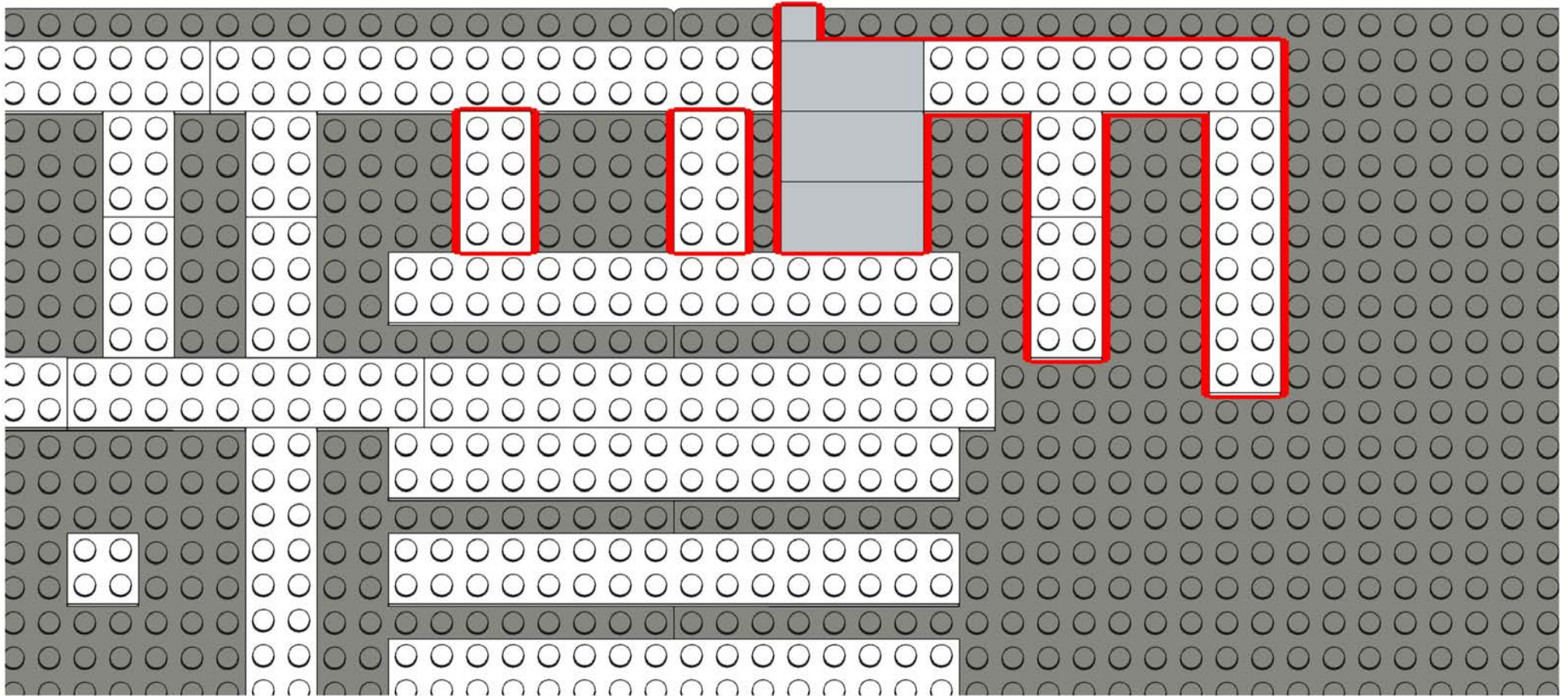
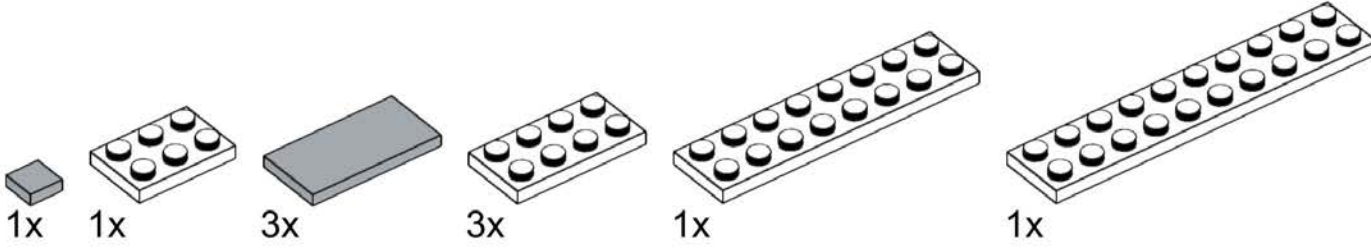

# 5

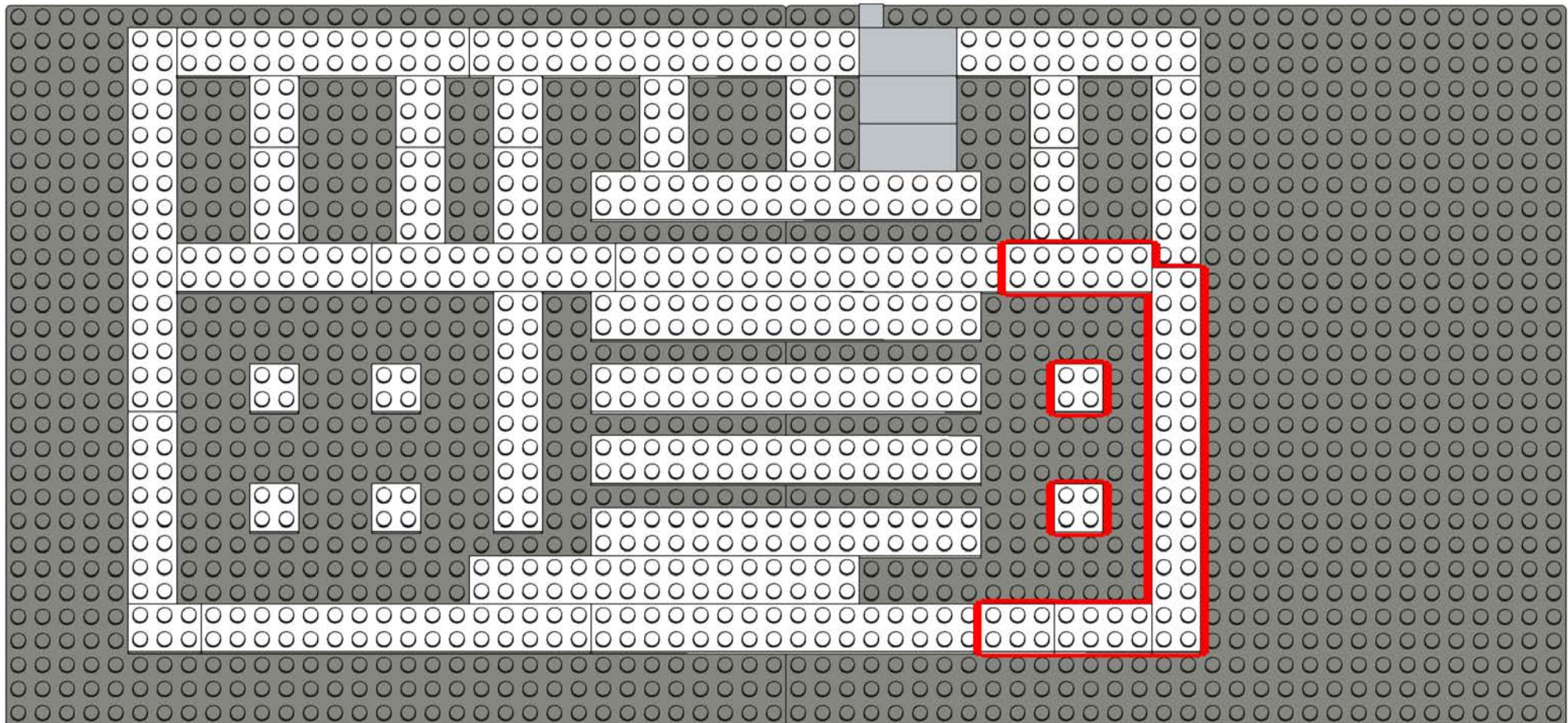
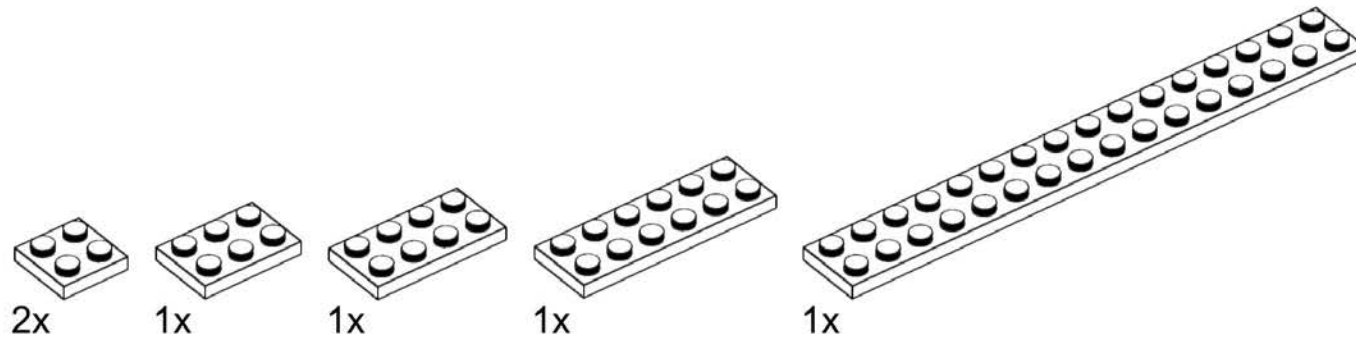

# 6



1x



7x

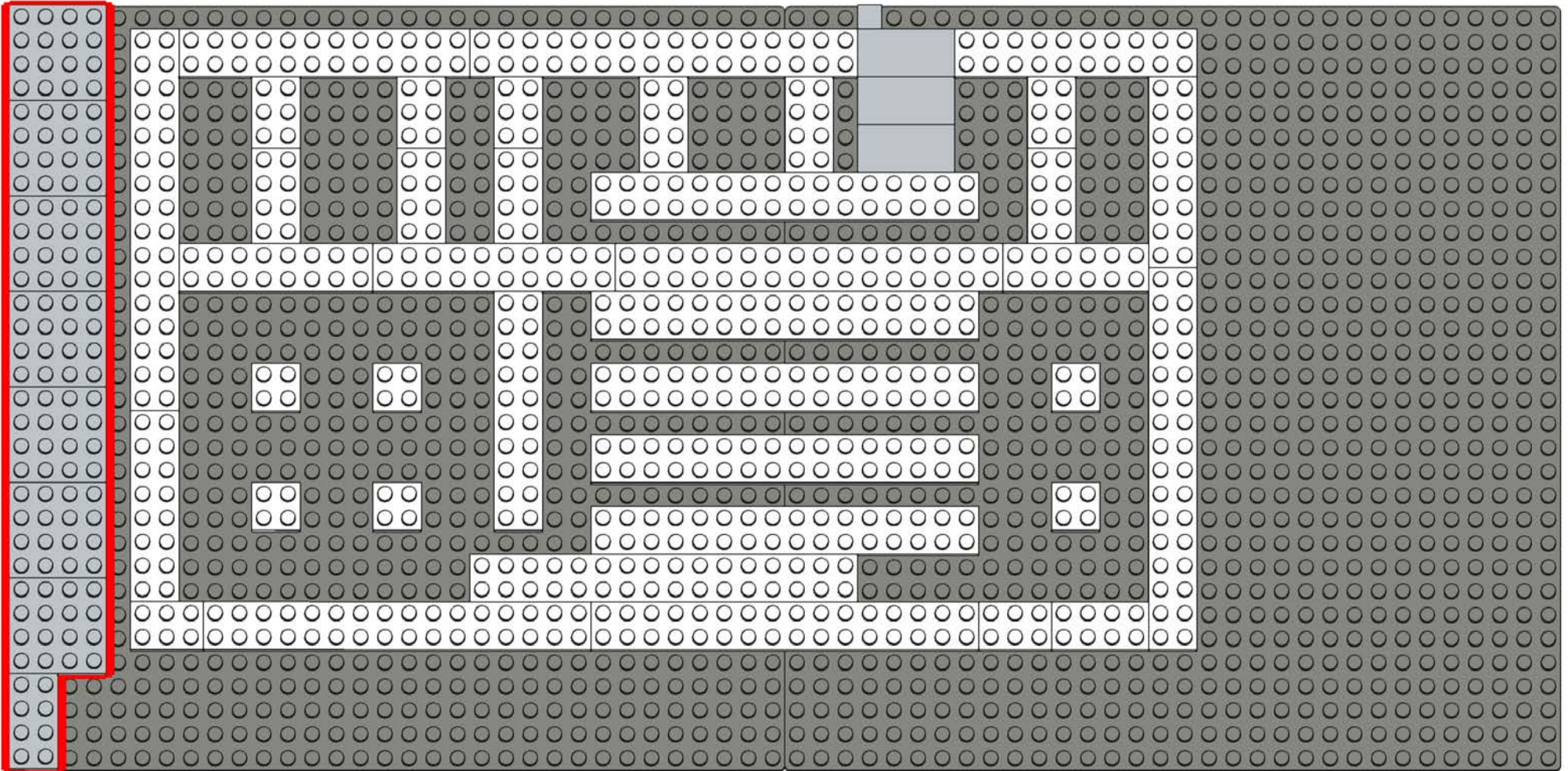

# 7



12x

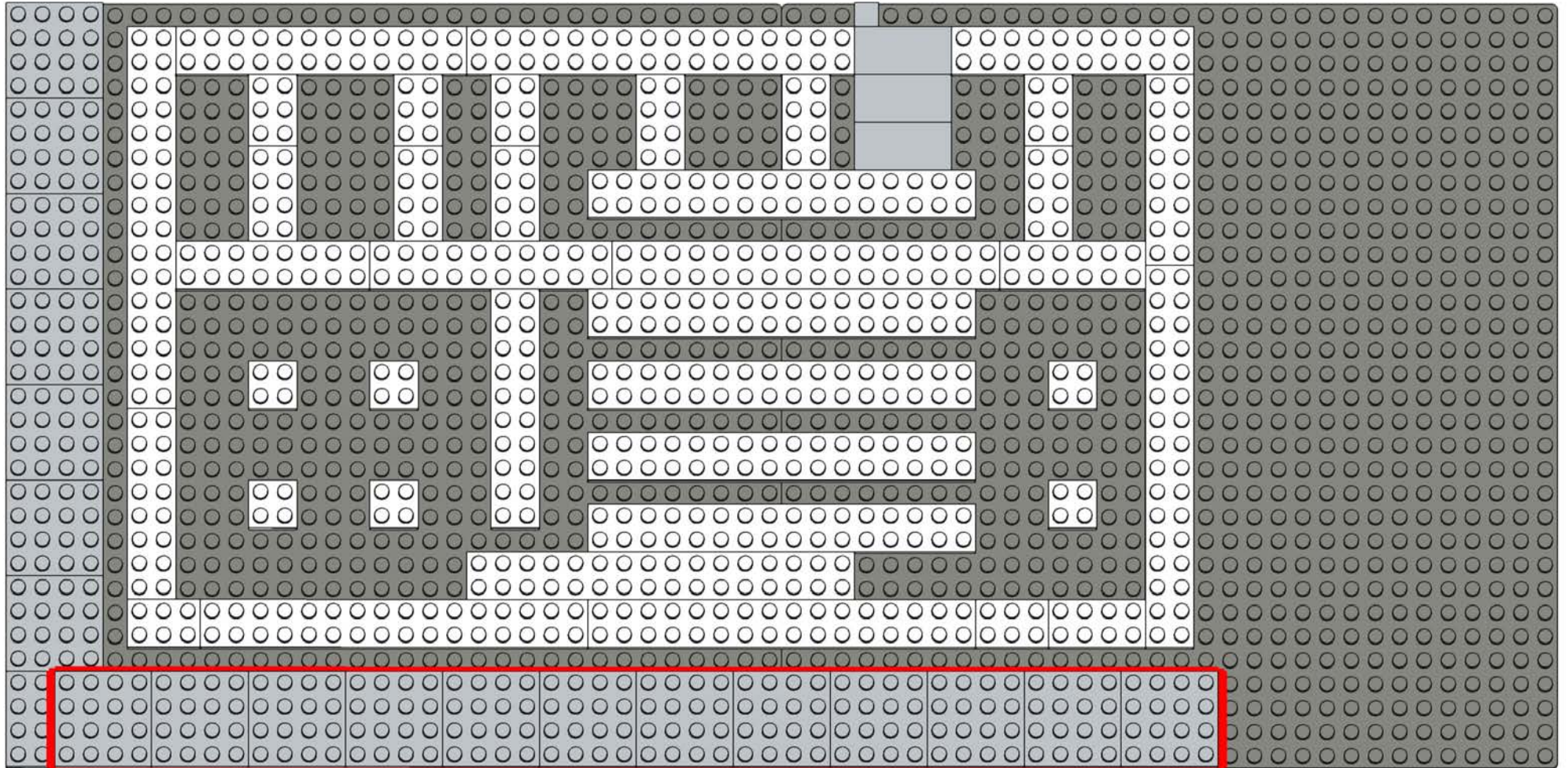



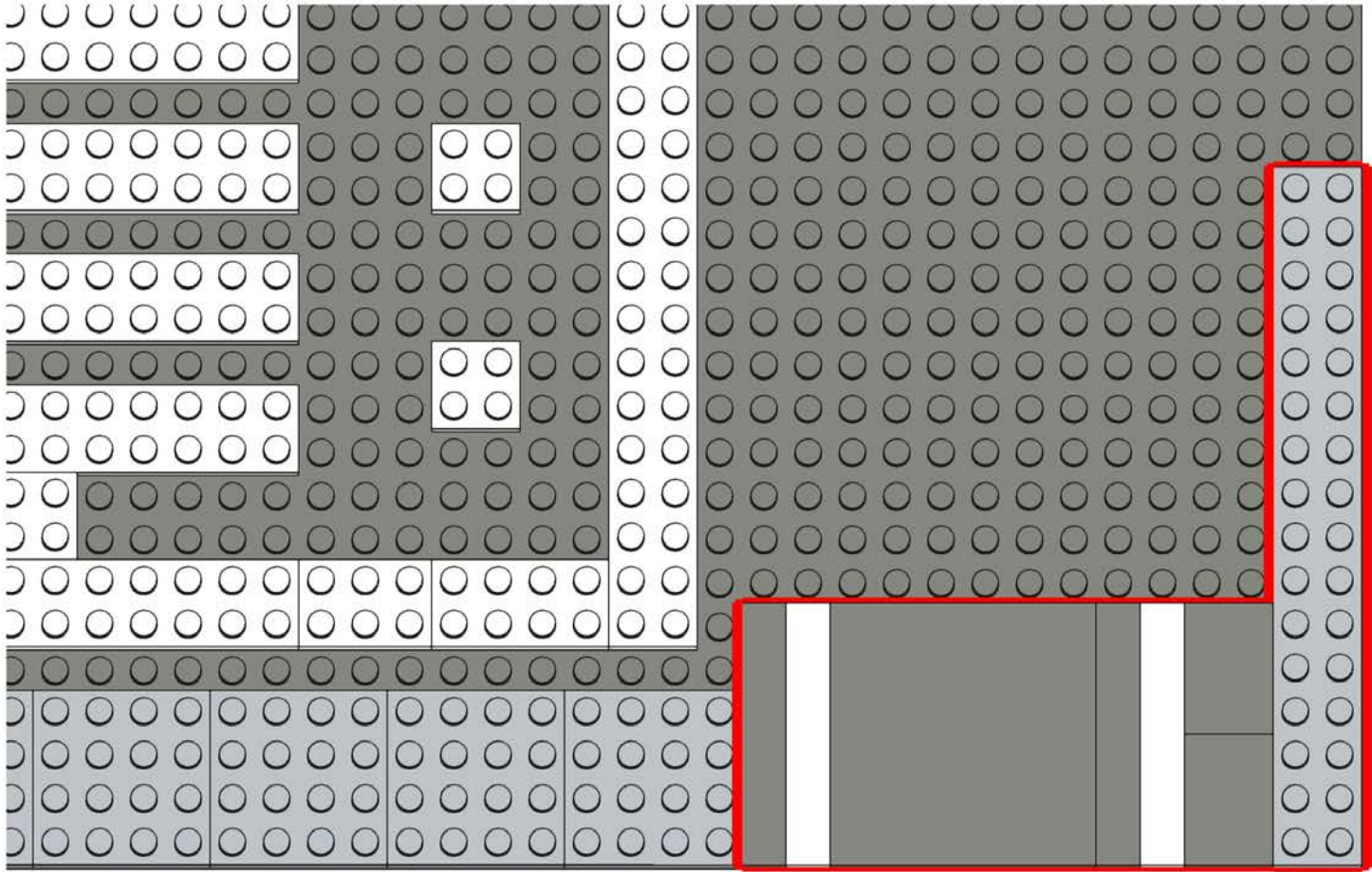

8



2x

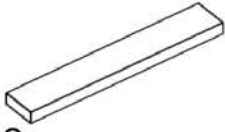

2x

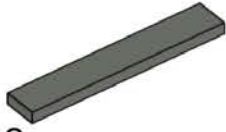

2x

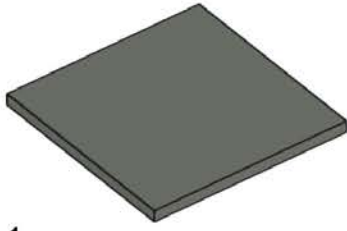

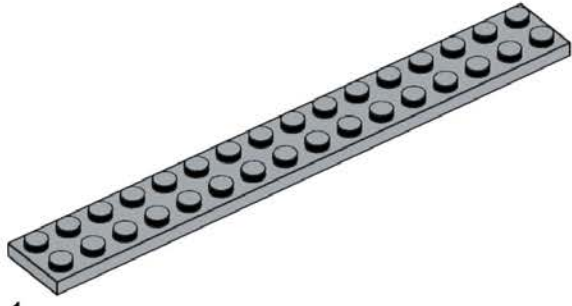

1x

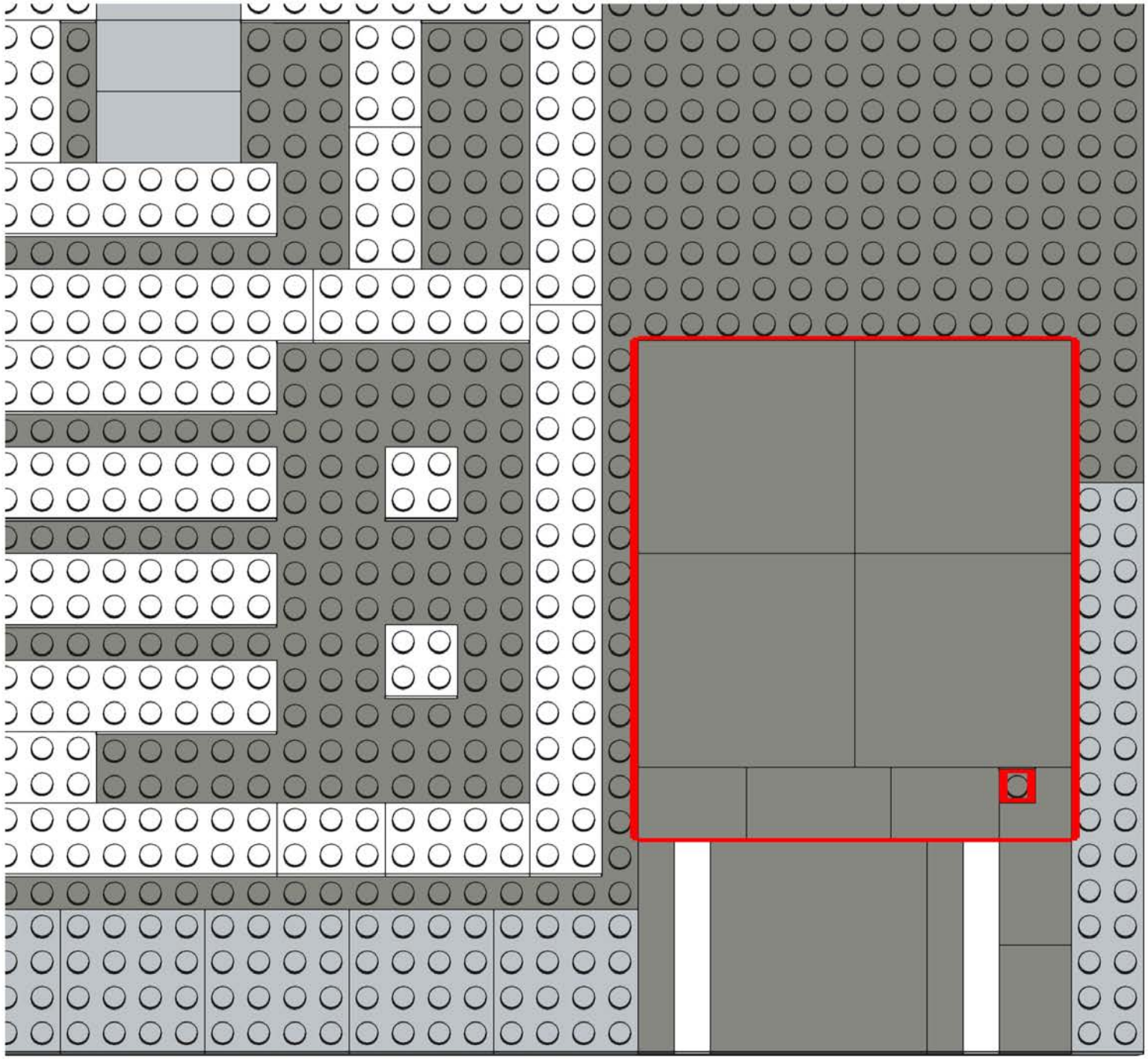

1x

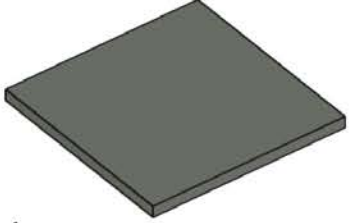

9

- 1x  2x 
- 1x 
- 4x 

# 10

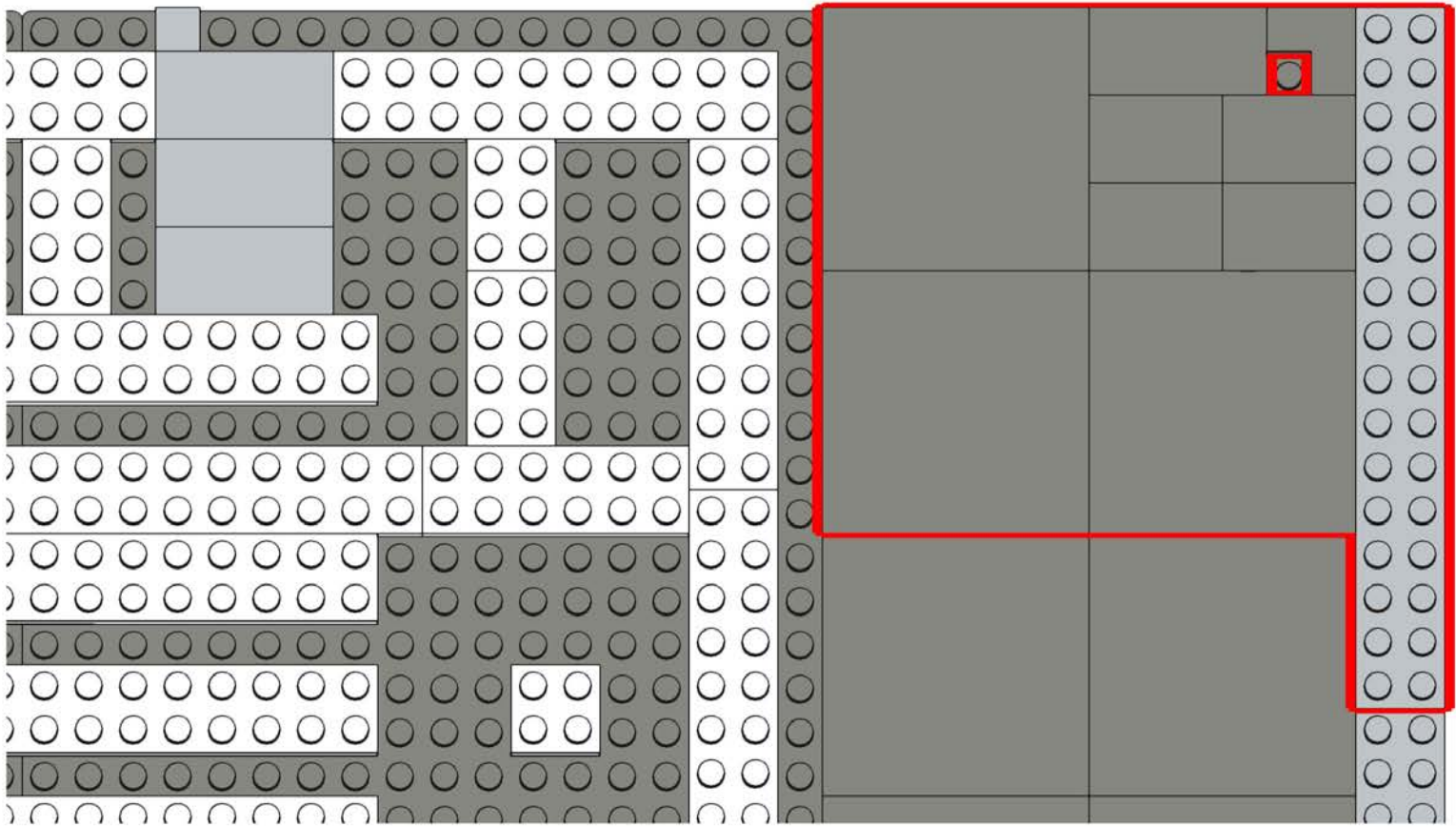
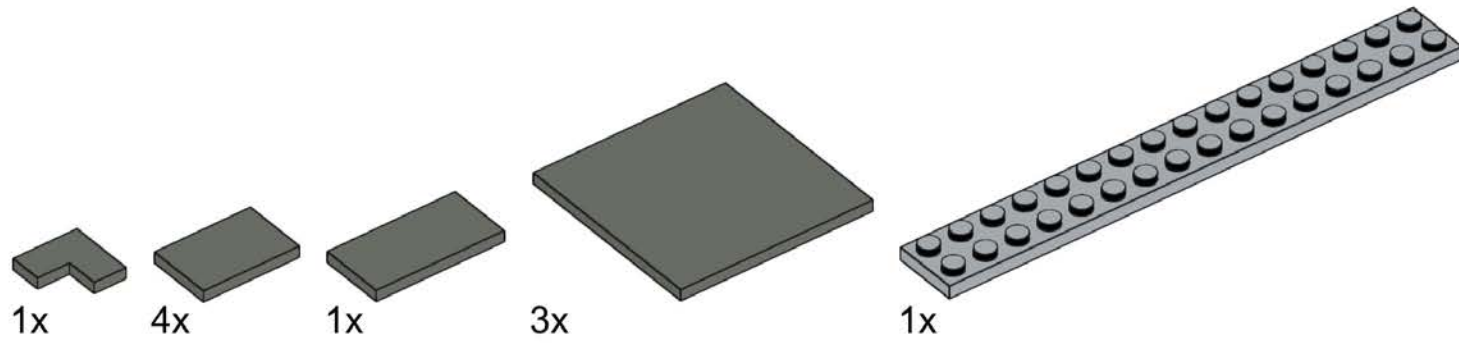

# 11

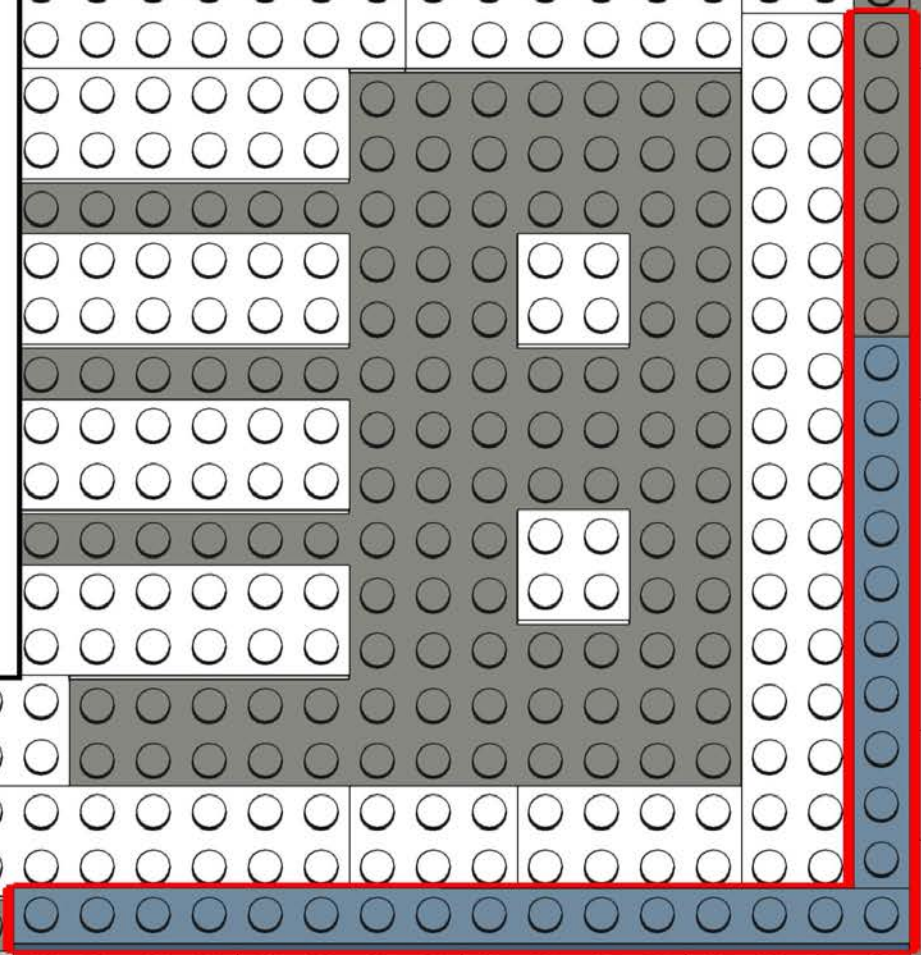
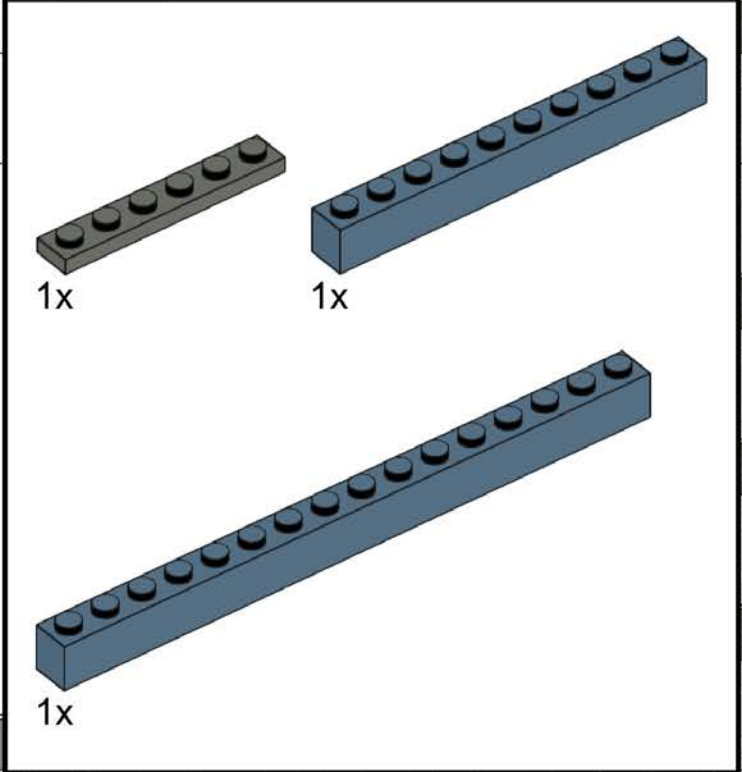

# 12

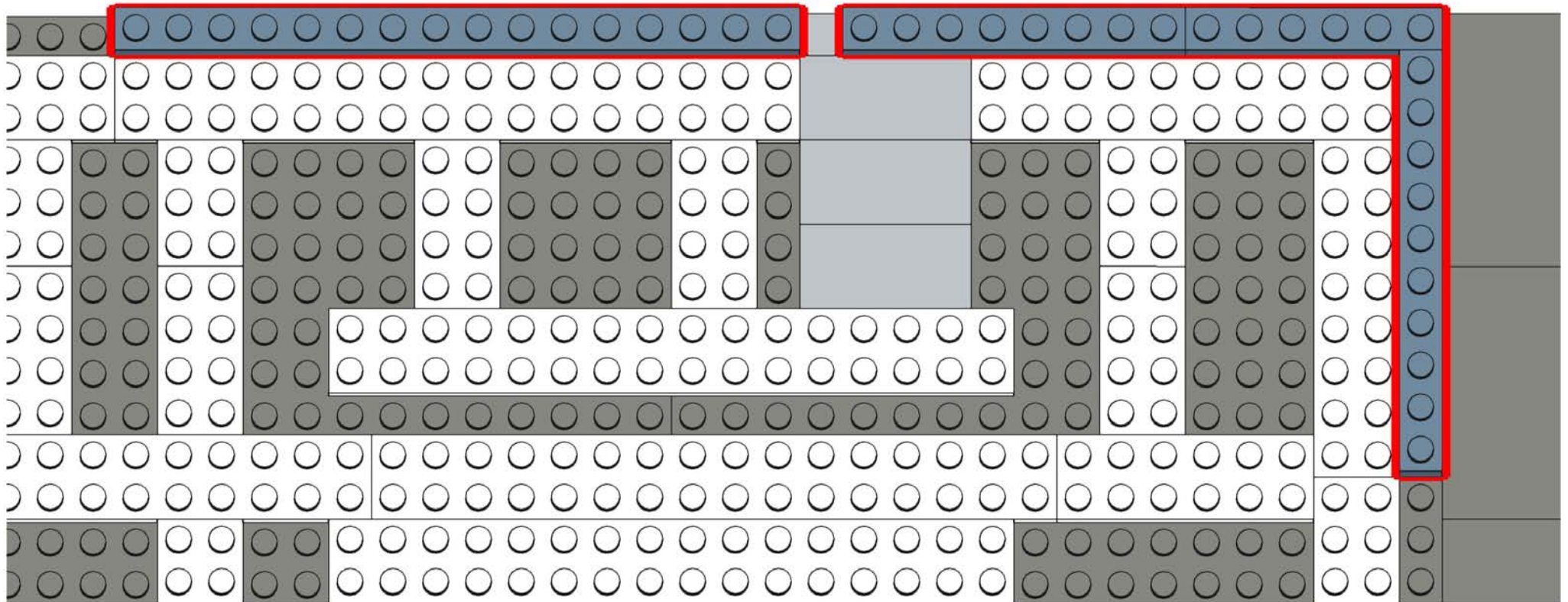
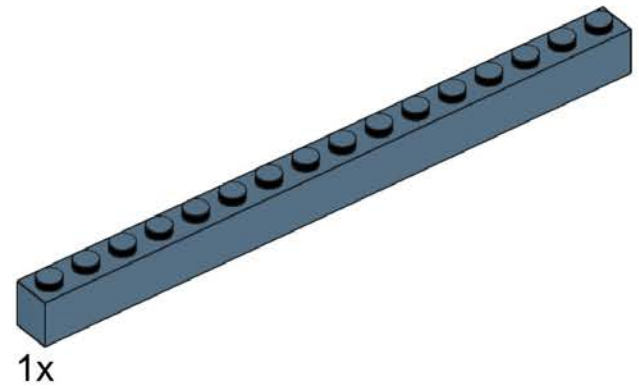
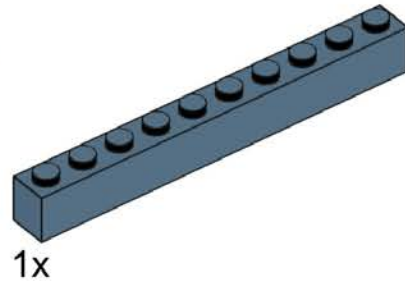
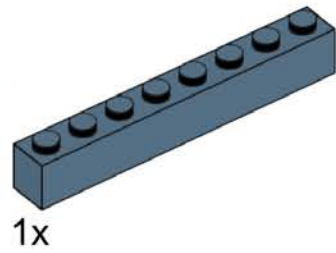
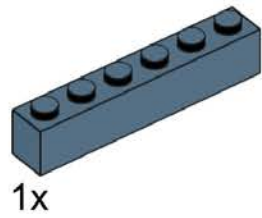

# 13

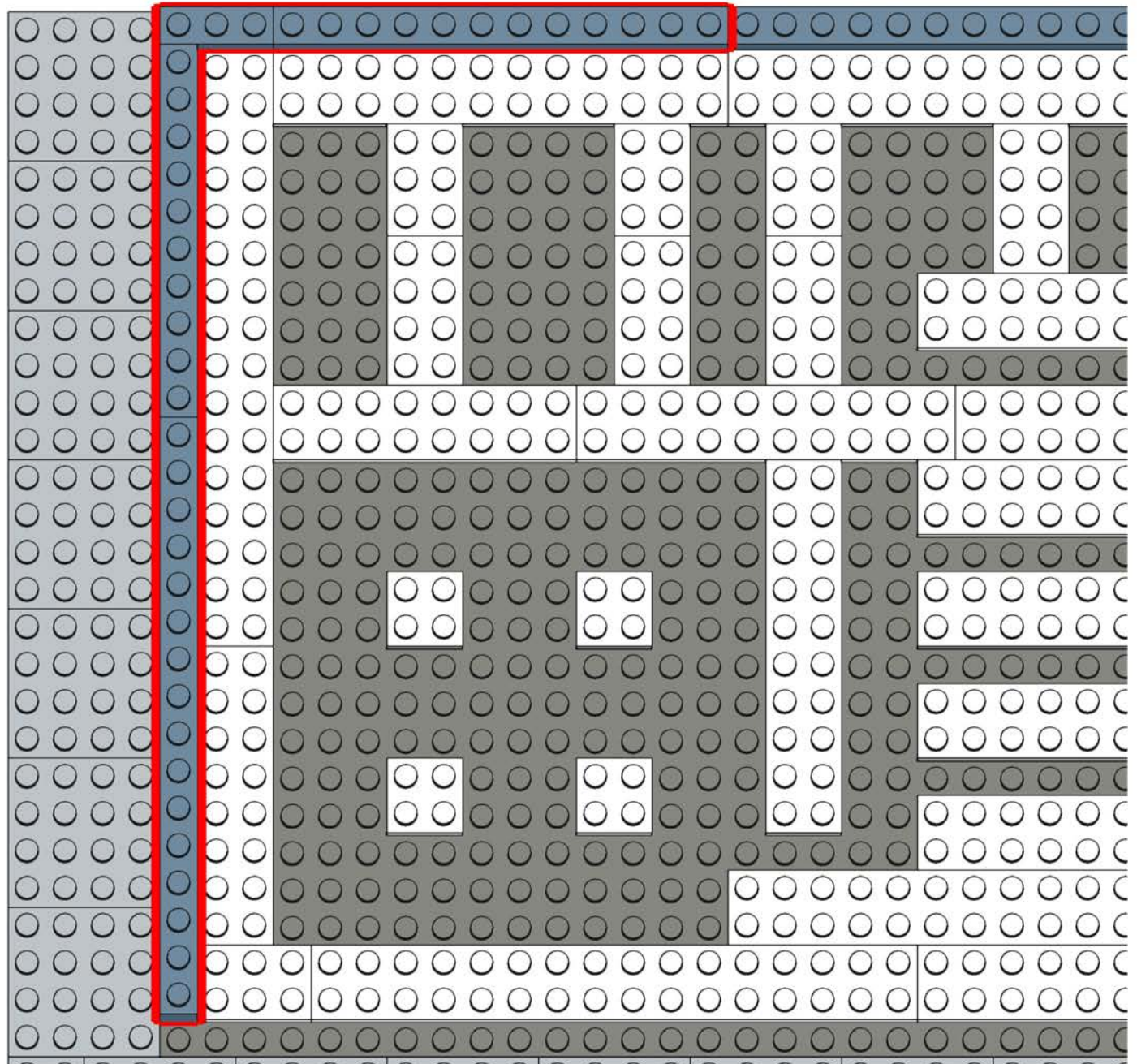
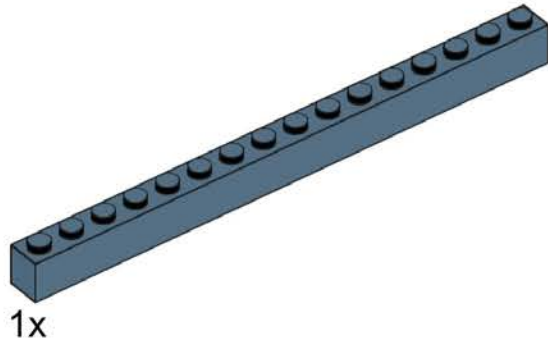
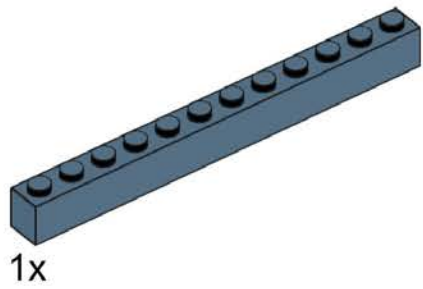
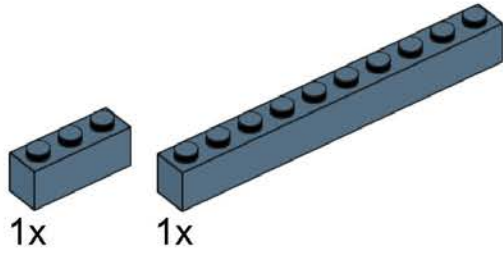

# 14

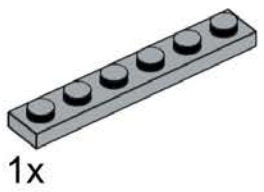
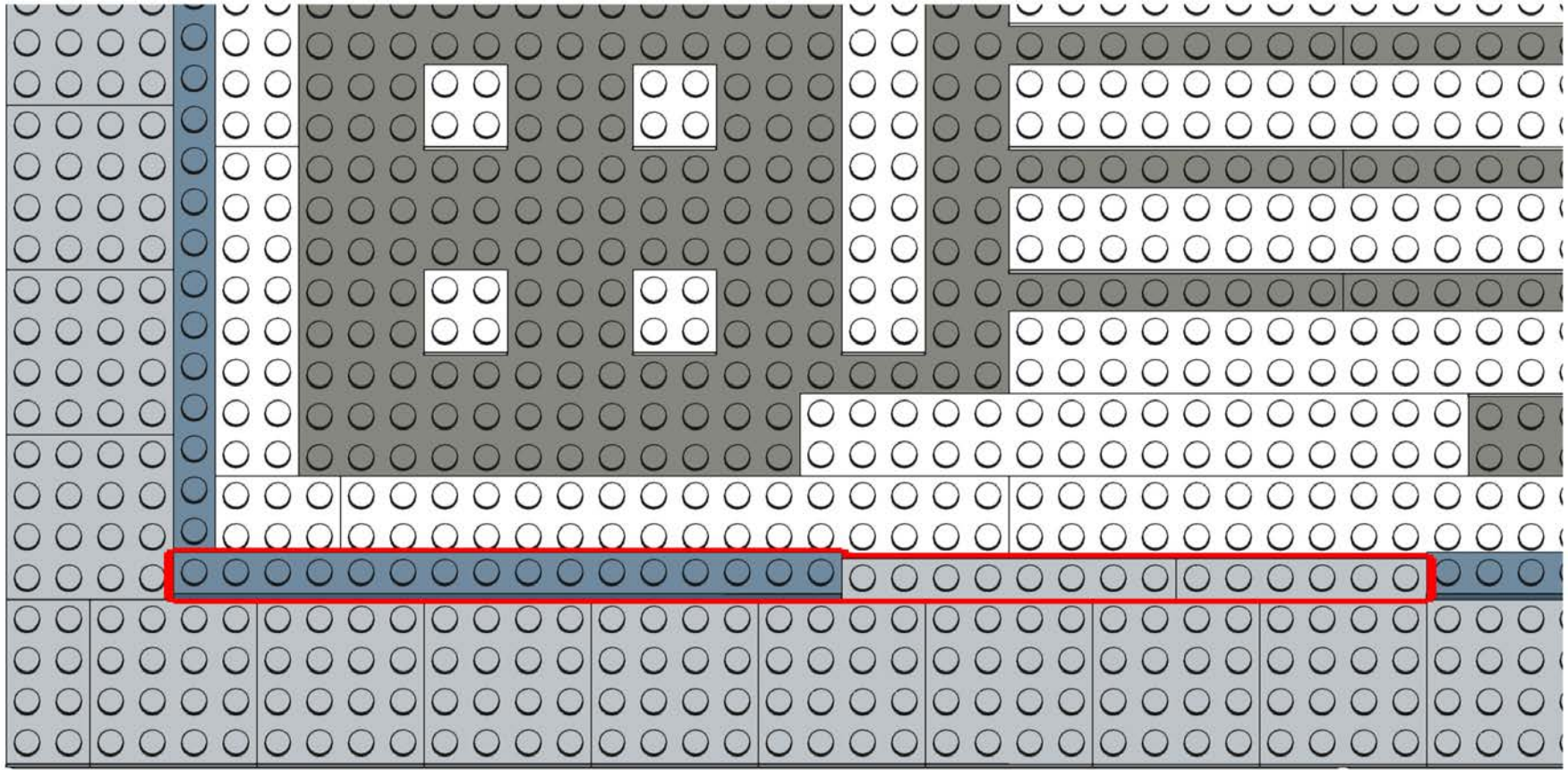

1x



1x

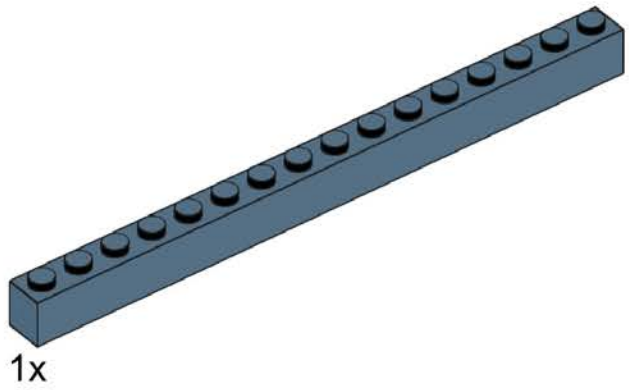

1x

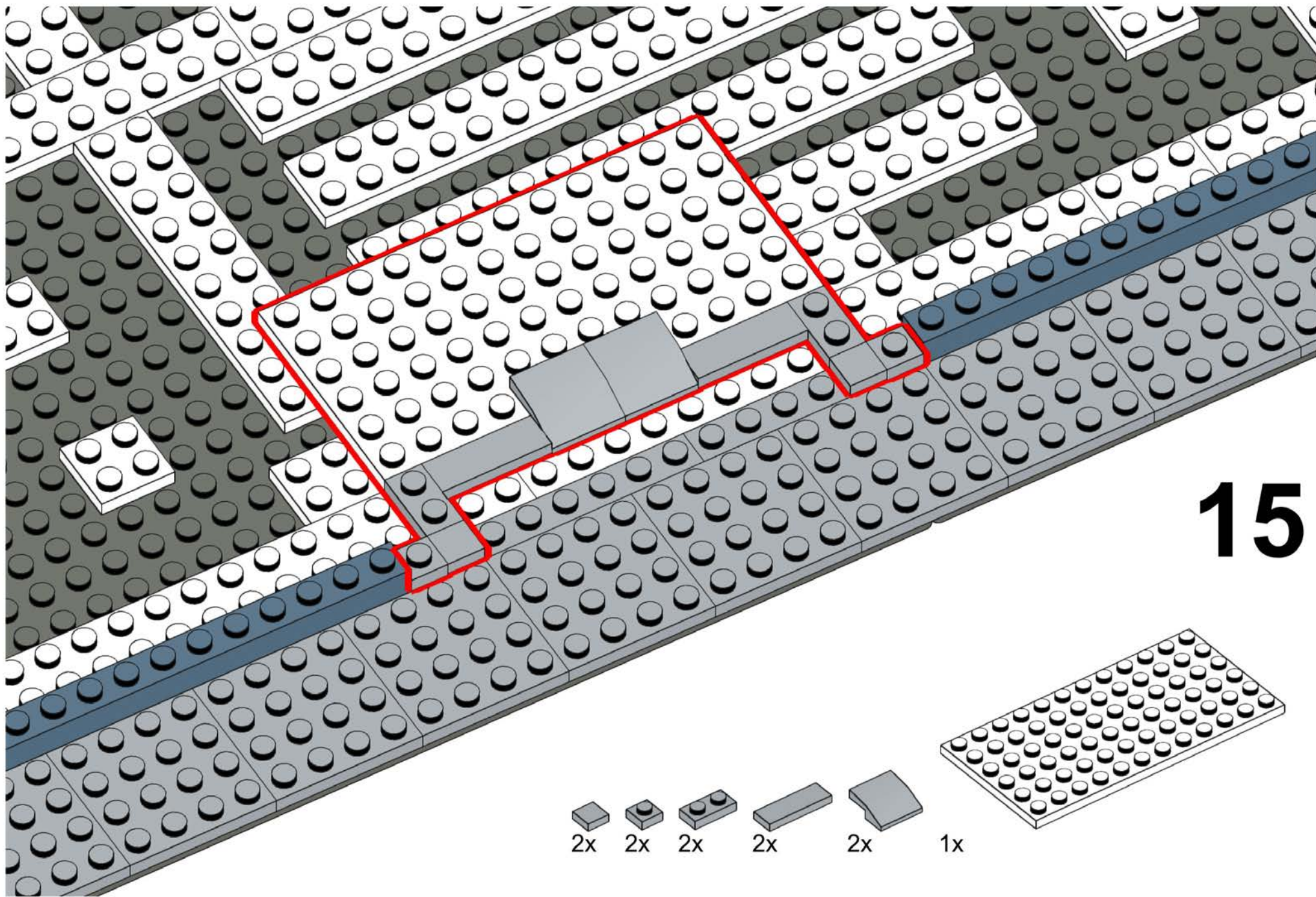

15



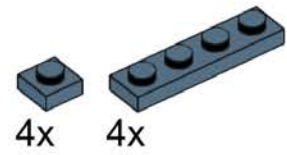
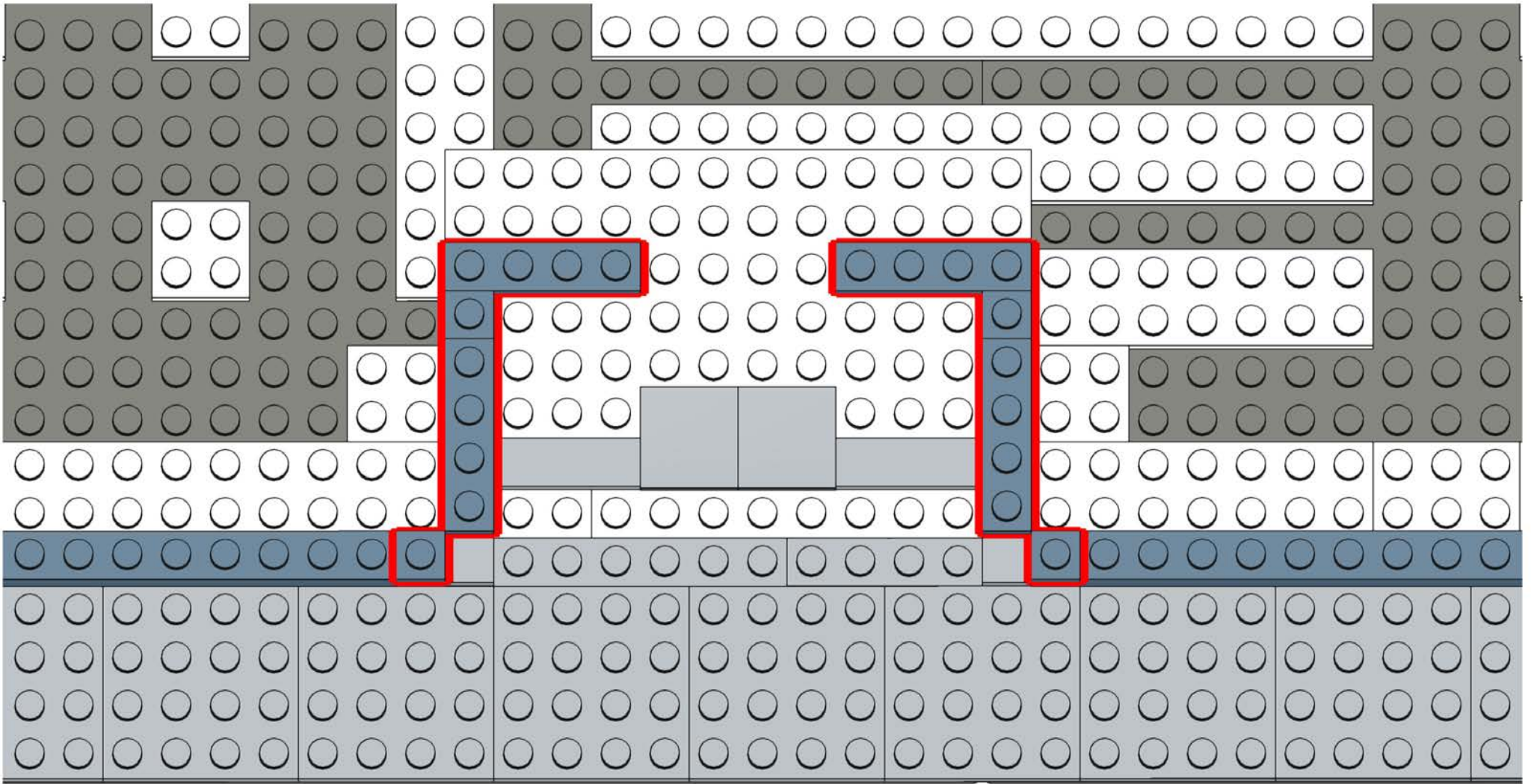

**16**

# 17

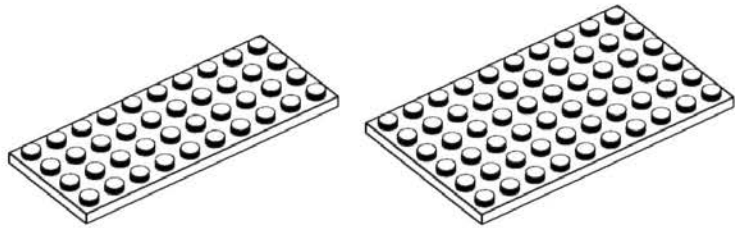

1x

2x

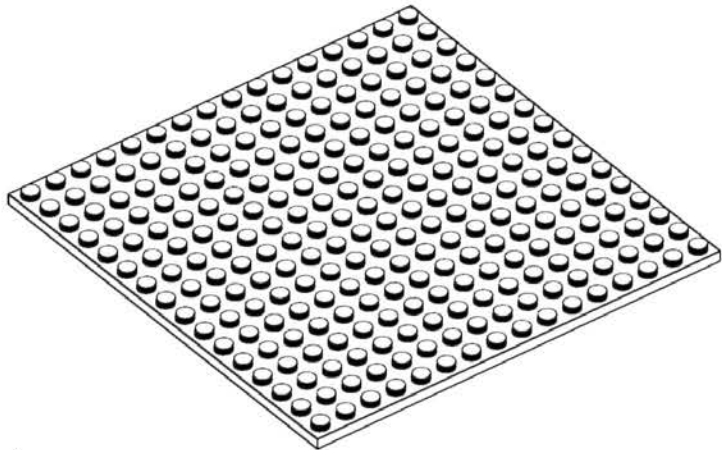

1x

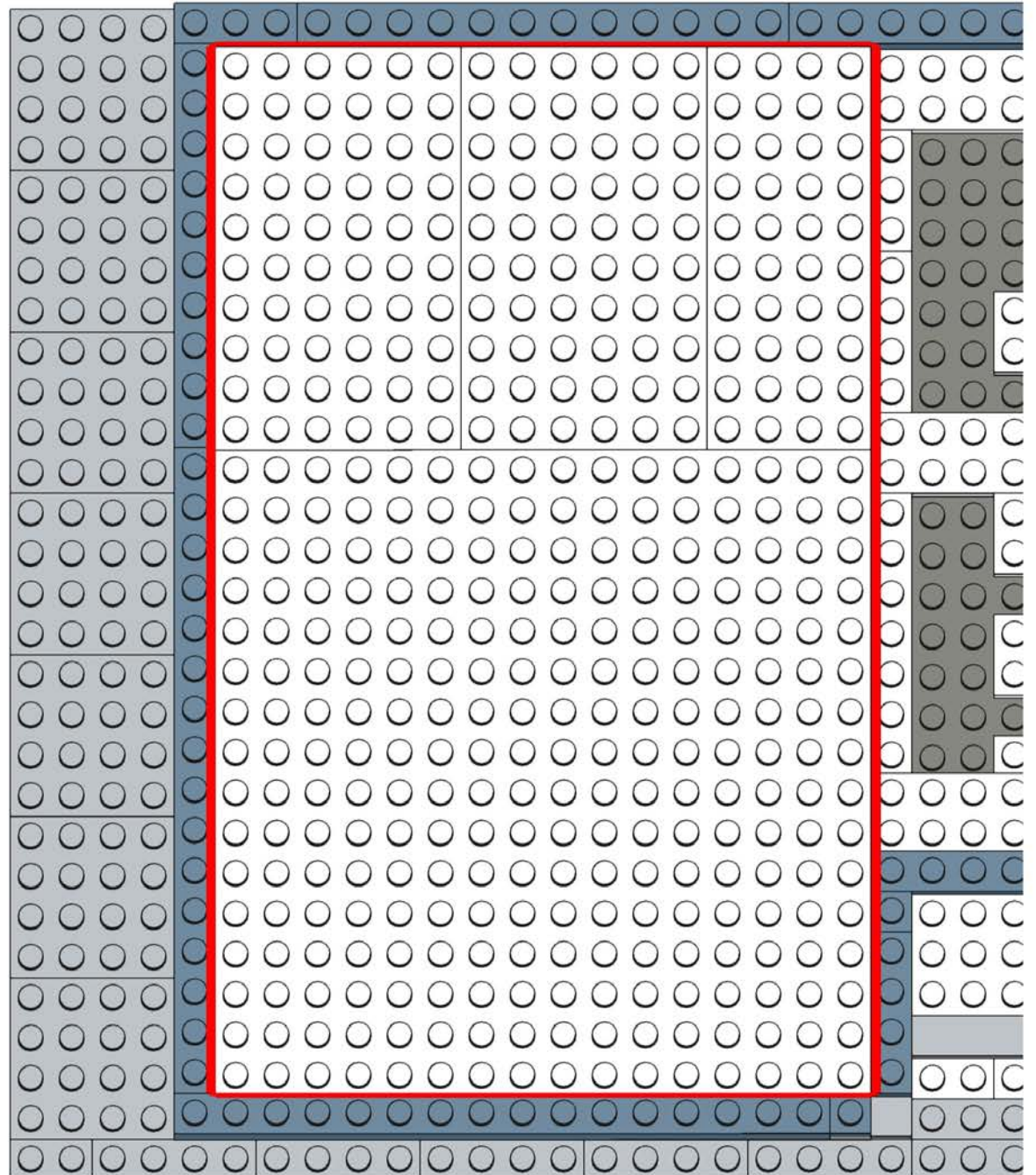

# 18

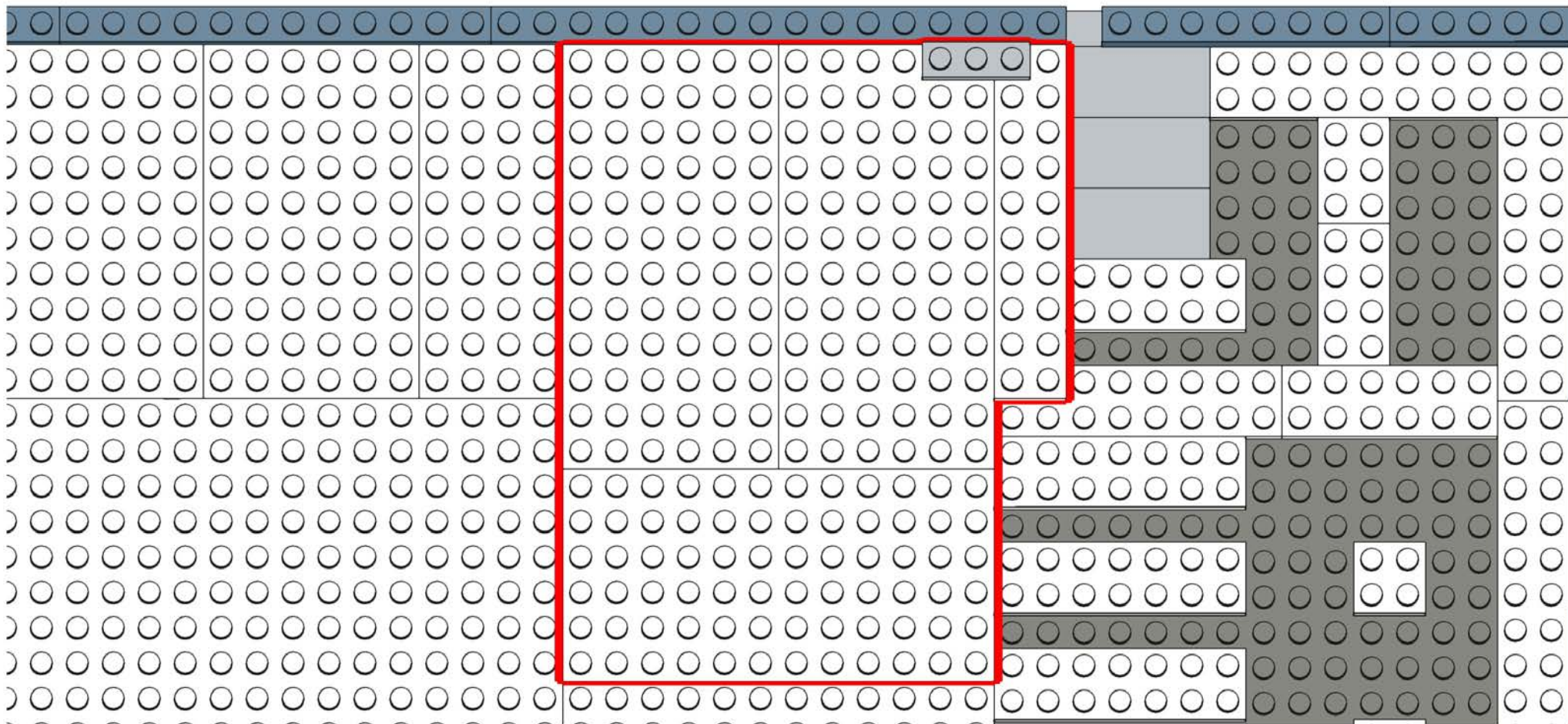
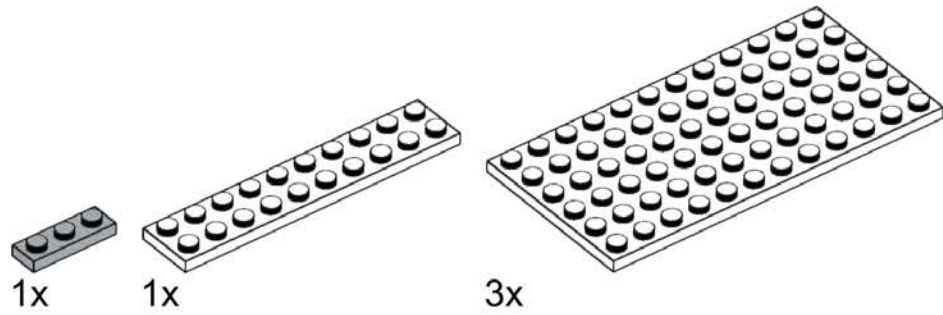

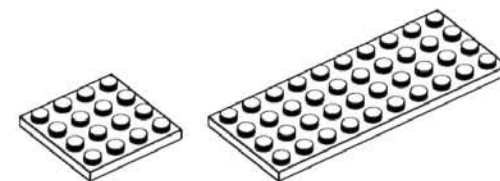
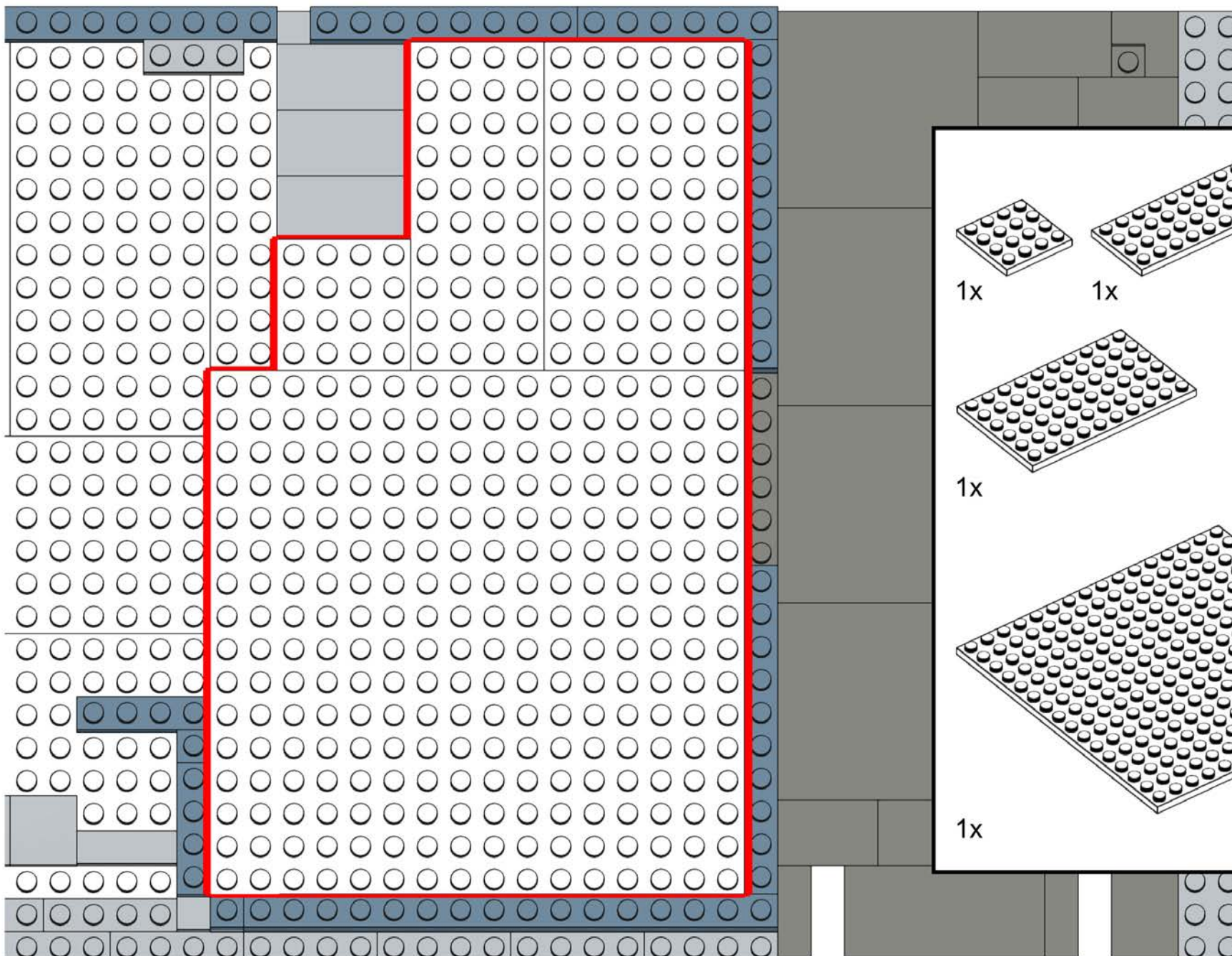

1x

1x

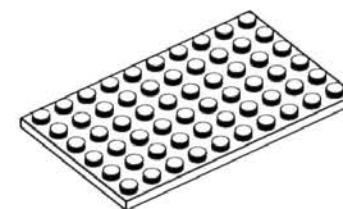

1x

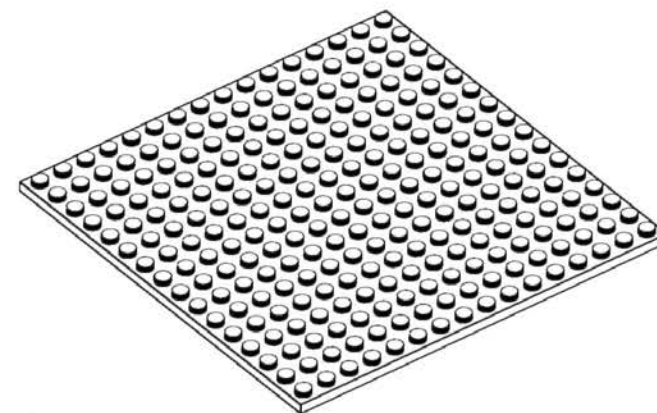

1x

# 20

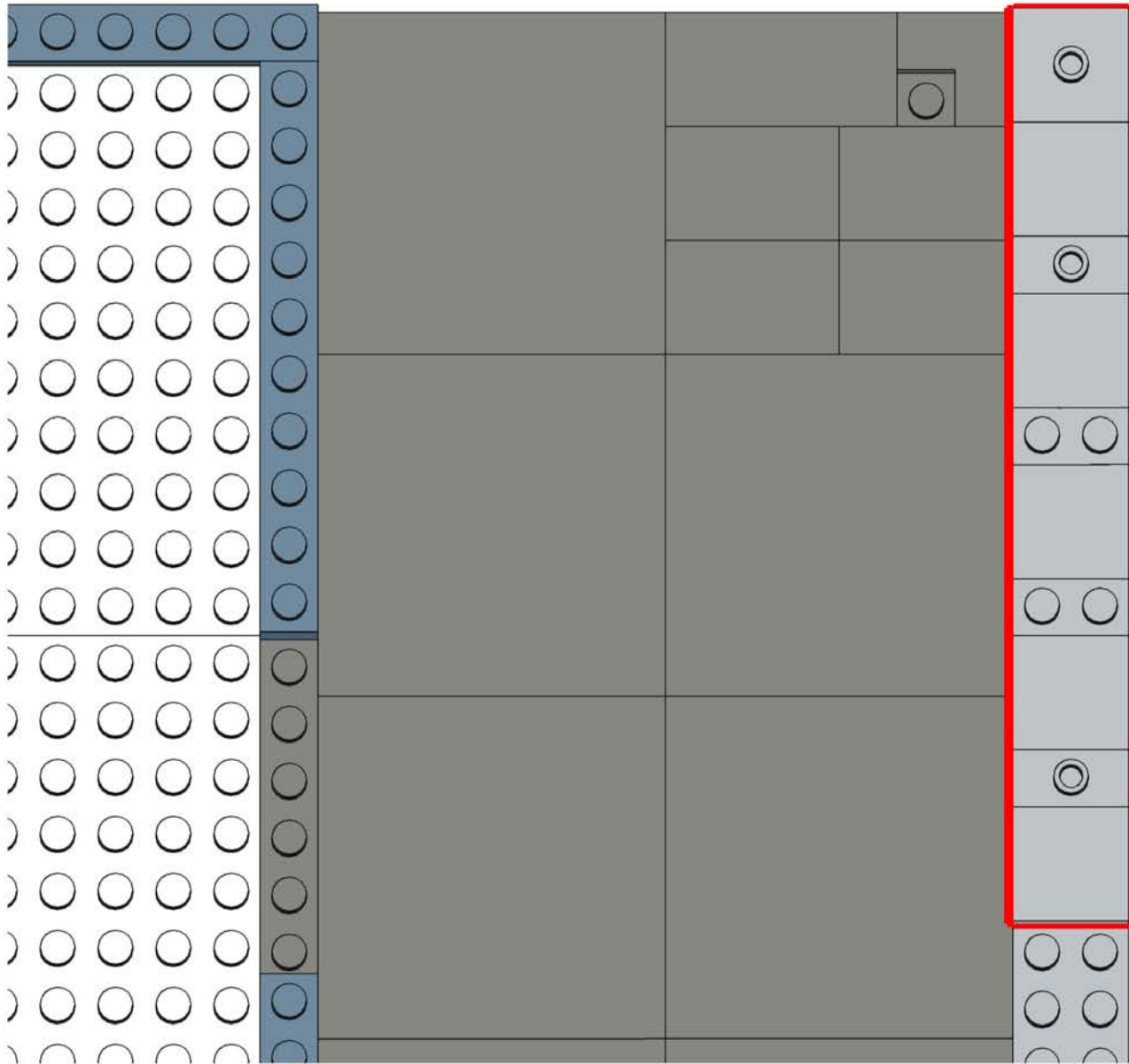

2x



2x

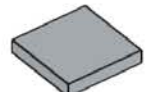

5x



1x

# 21

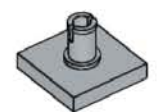
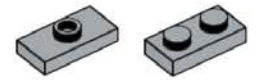
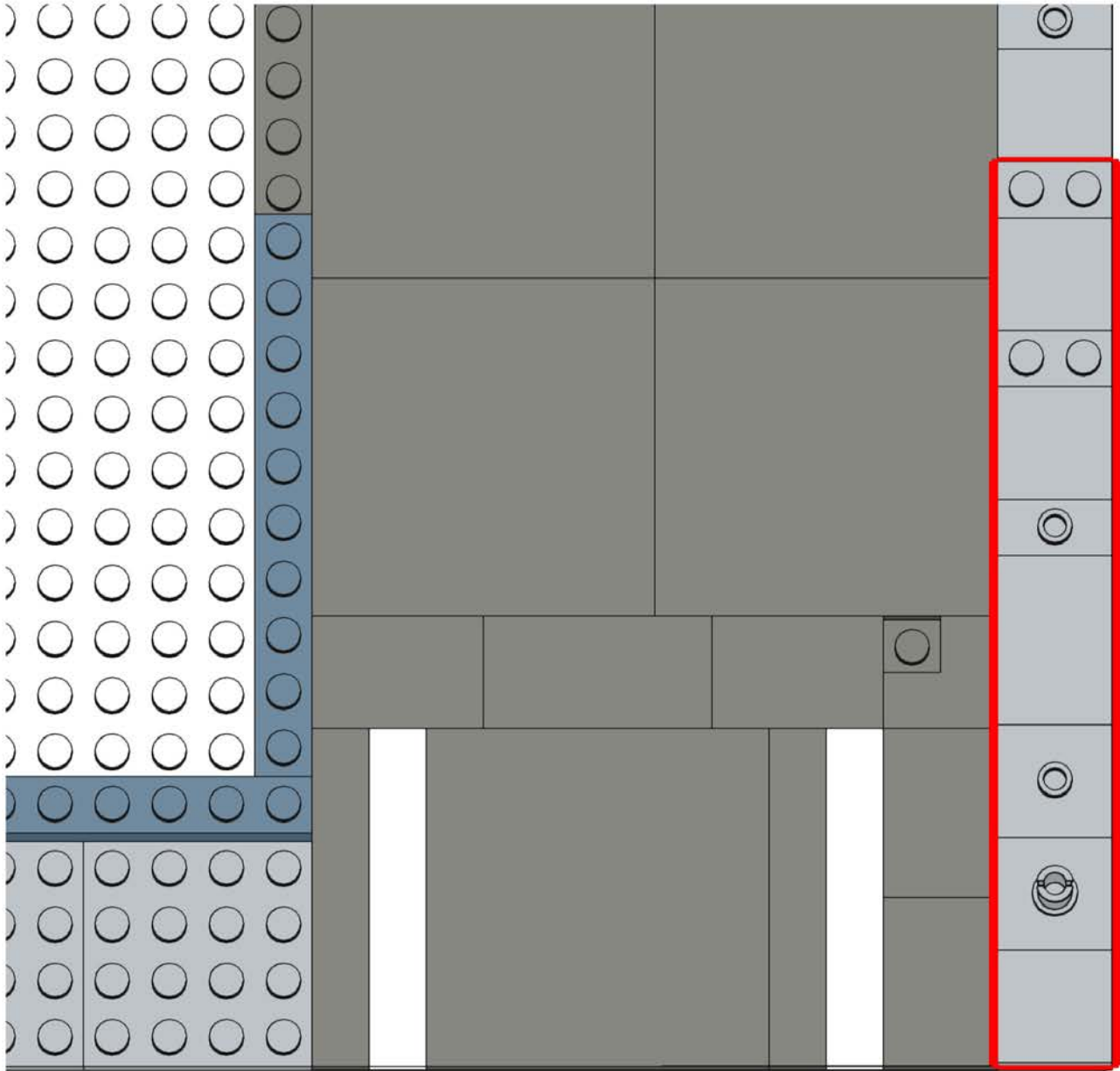

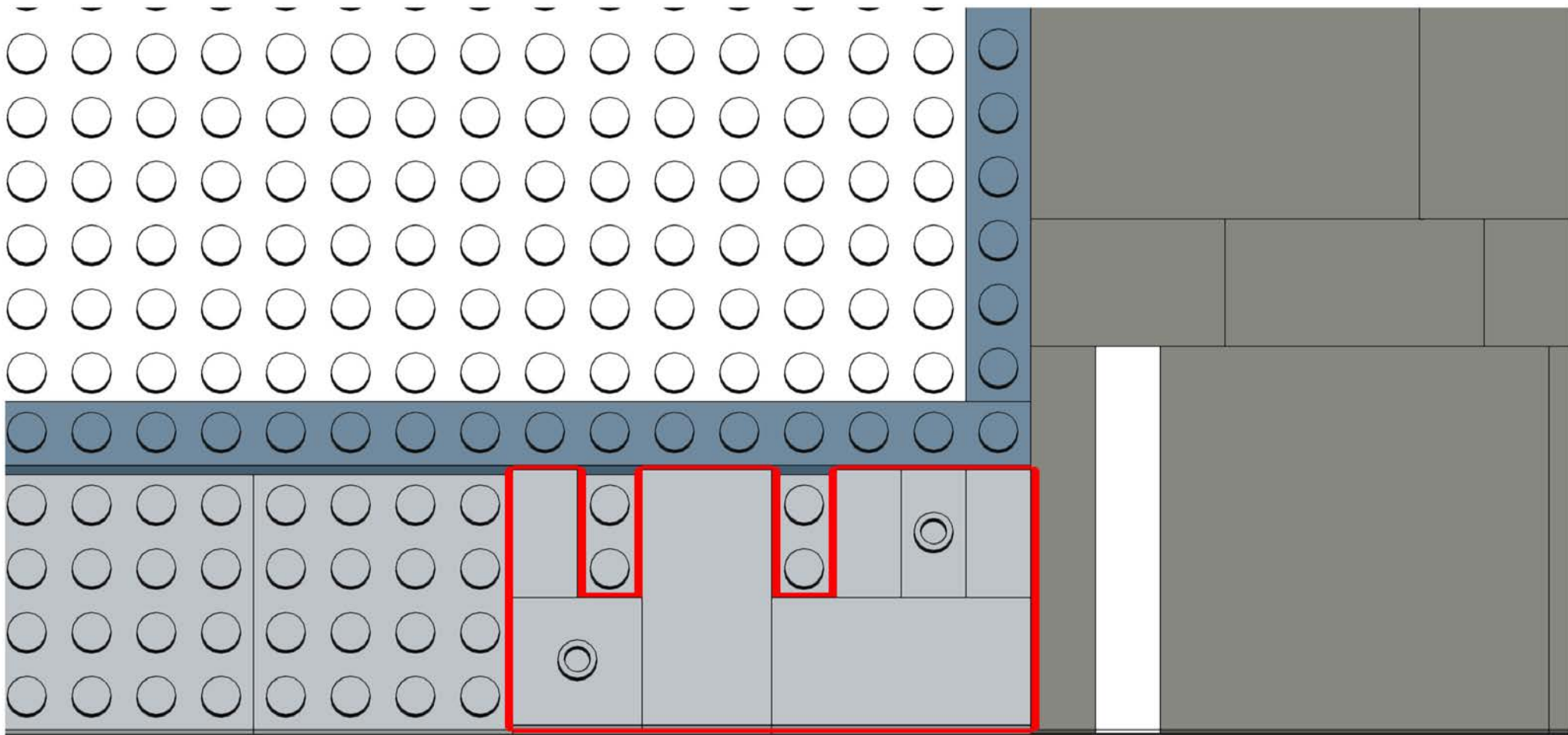

**22**

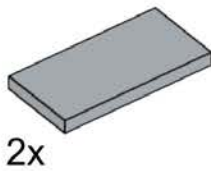
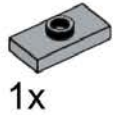
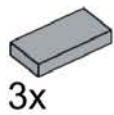

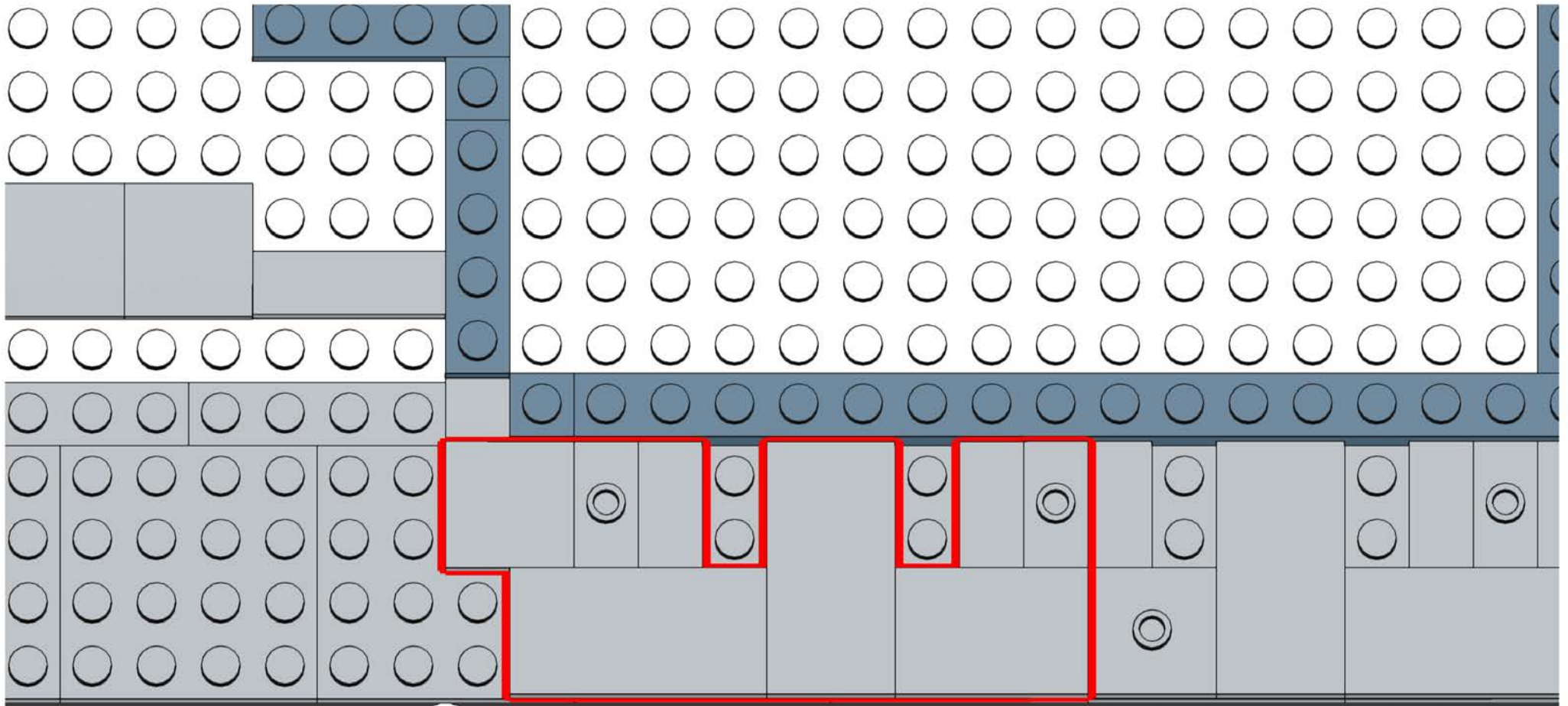

**23**

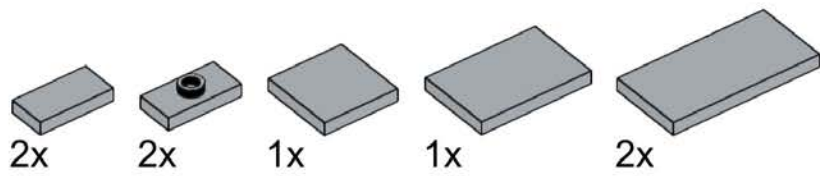



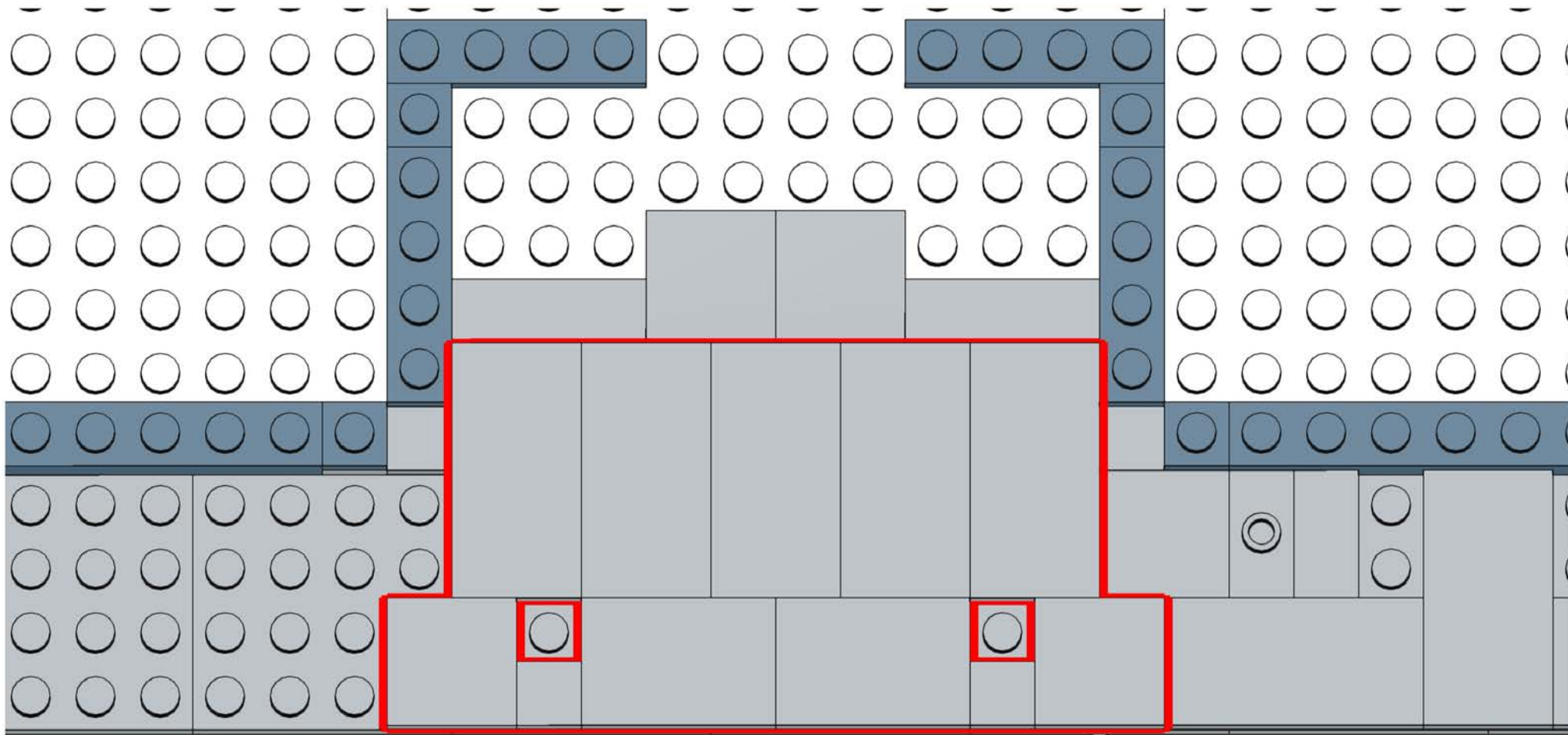

24

2x

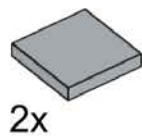

2x

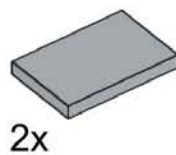

2x

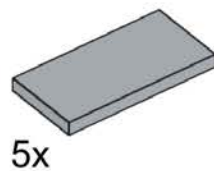

5x

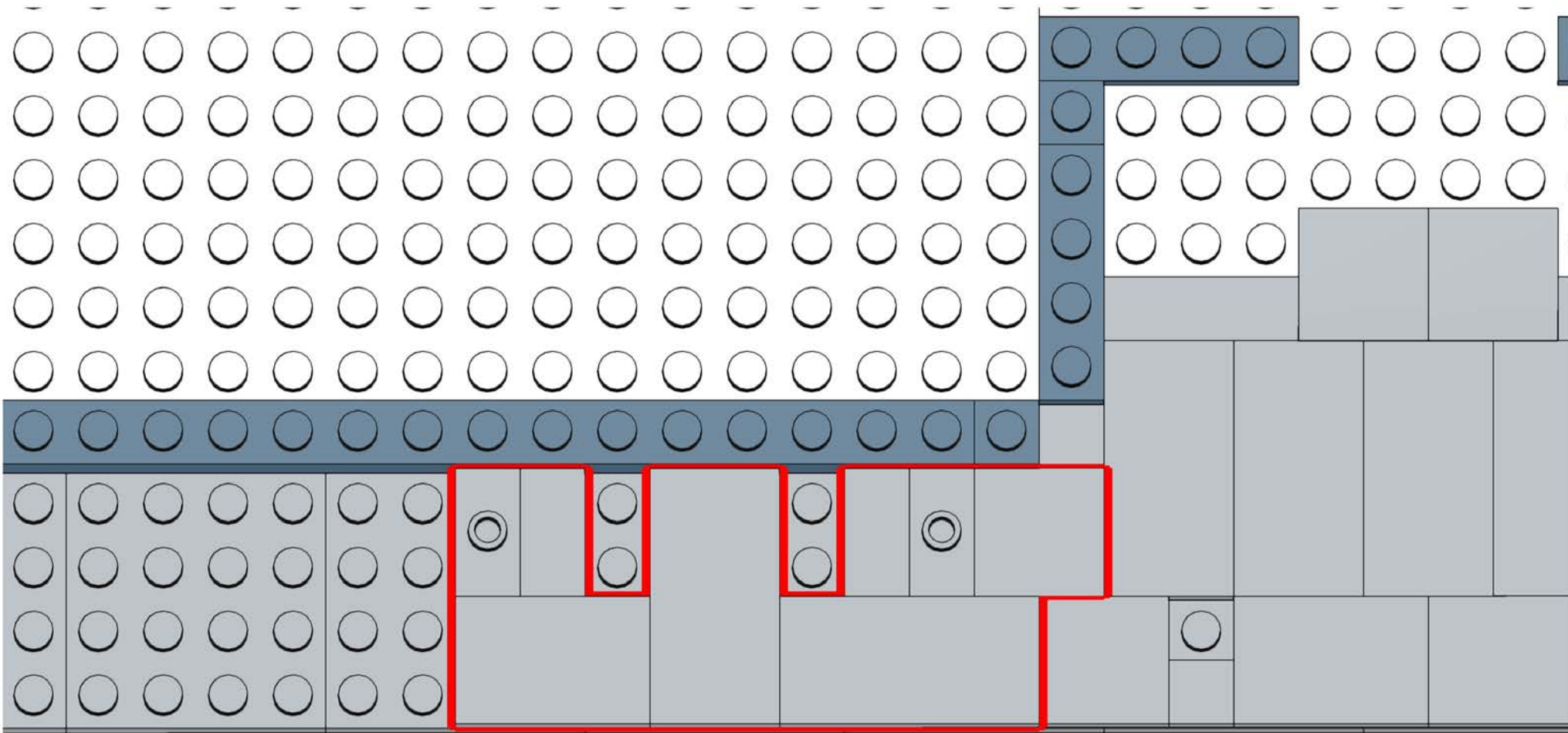

25



2x



2x

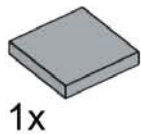

1x

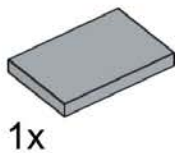

1x

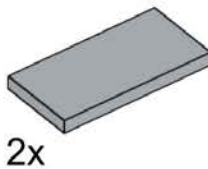

2x

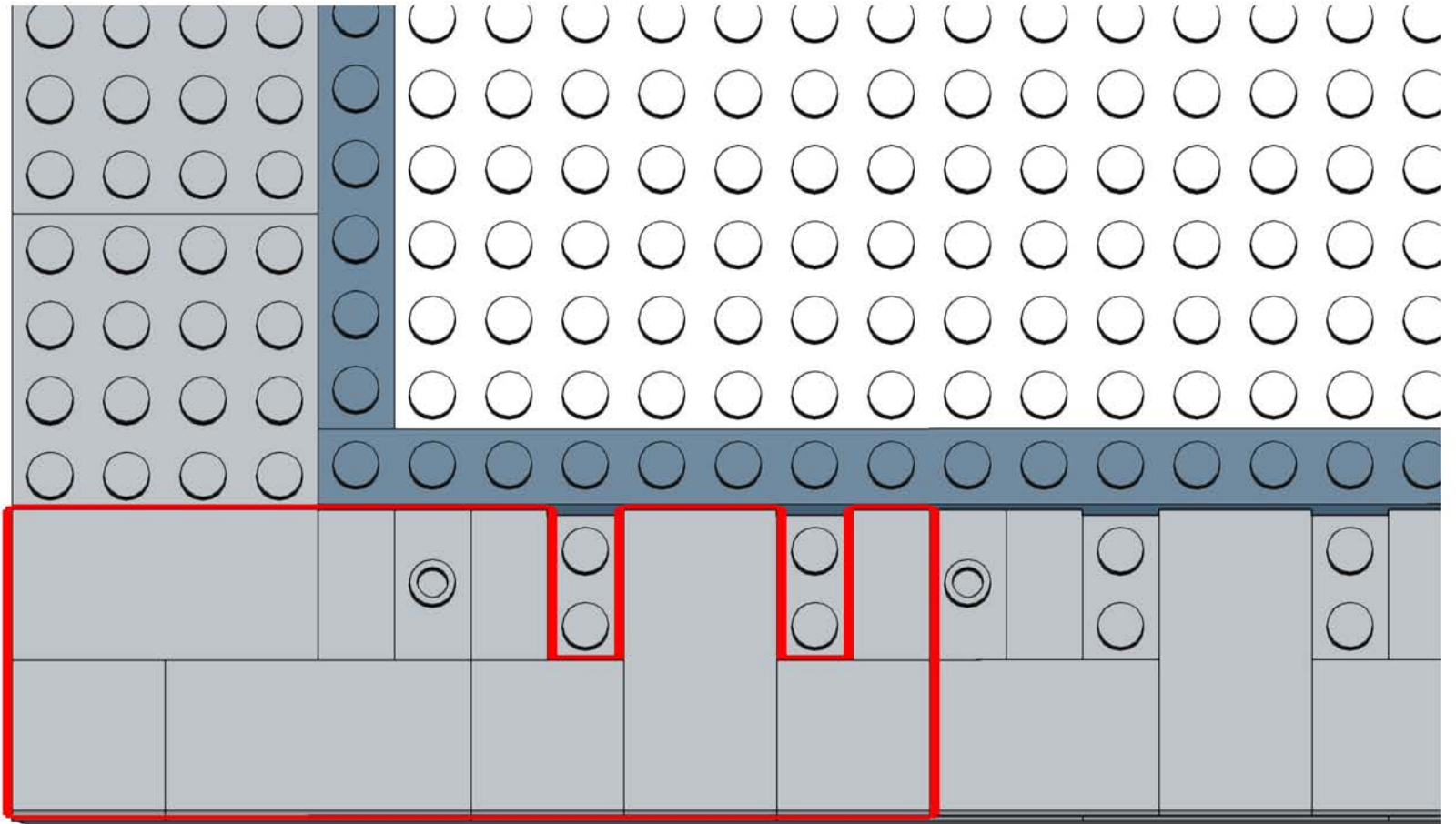

26

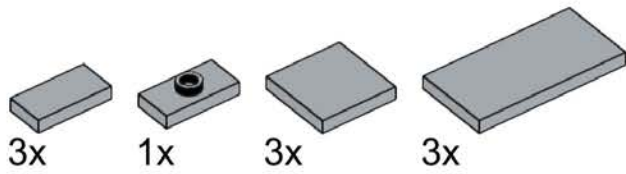

# 27

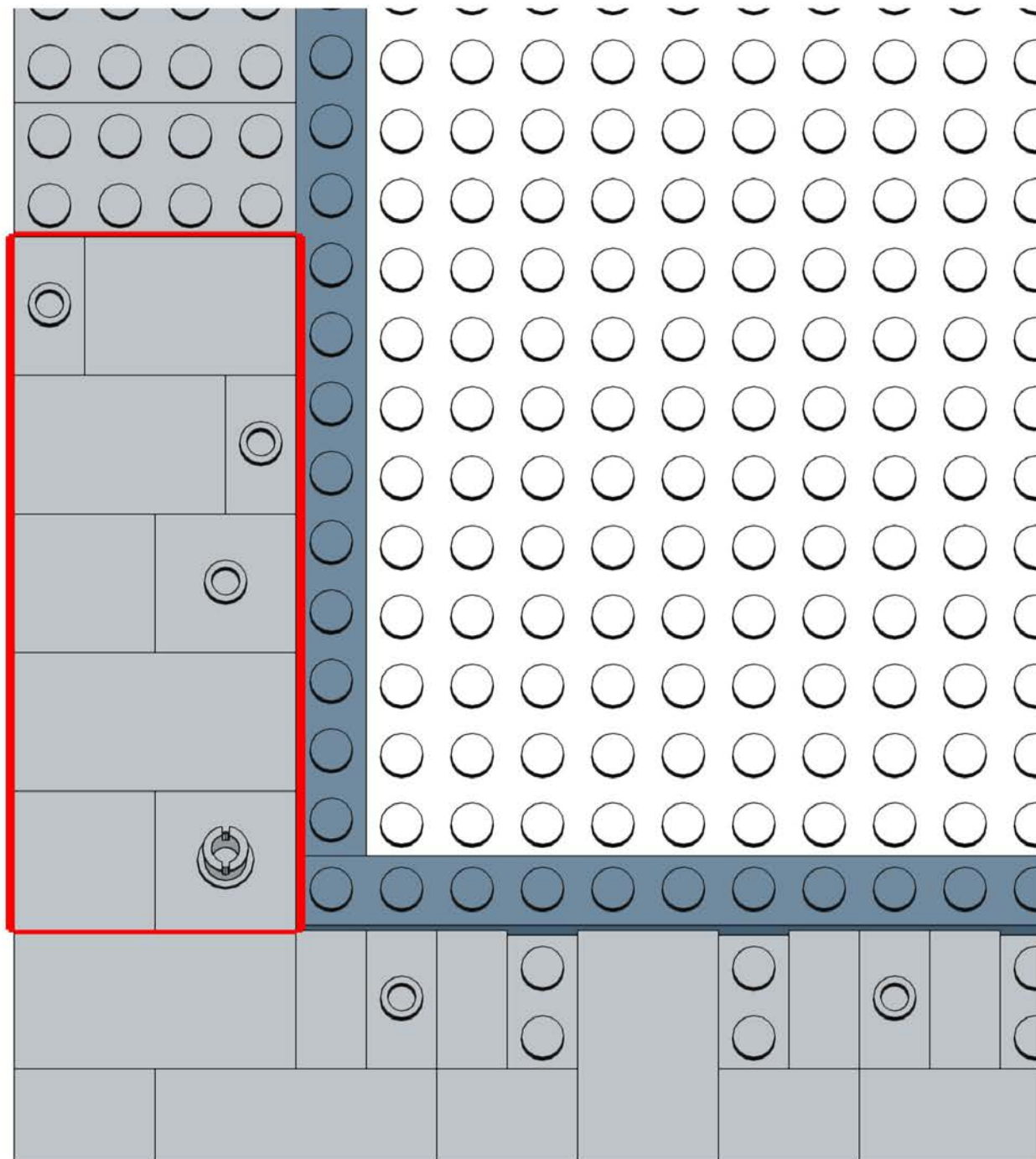
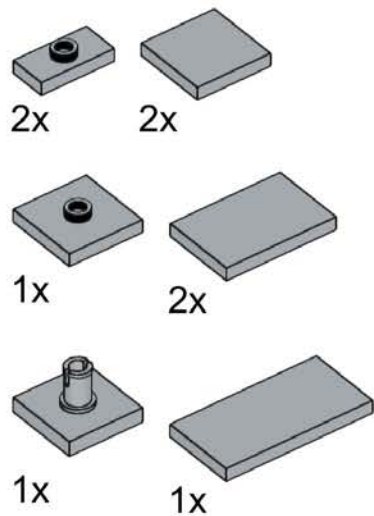

# 28

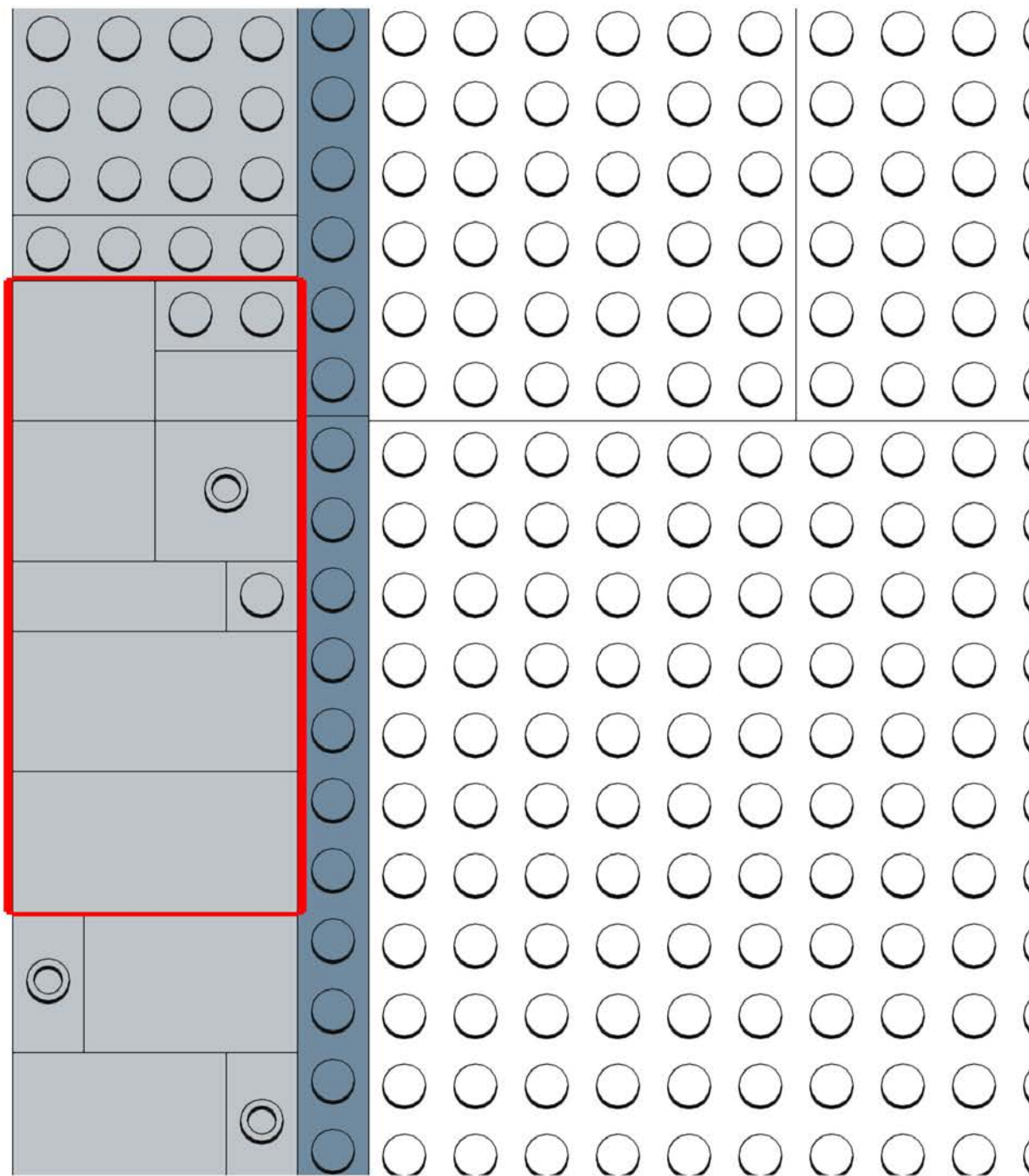
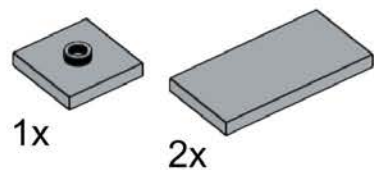
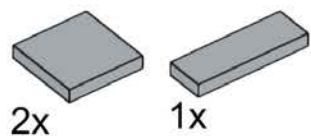
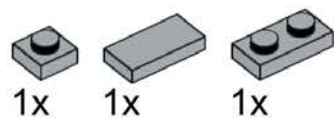

# 29

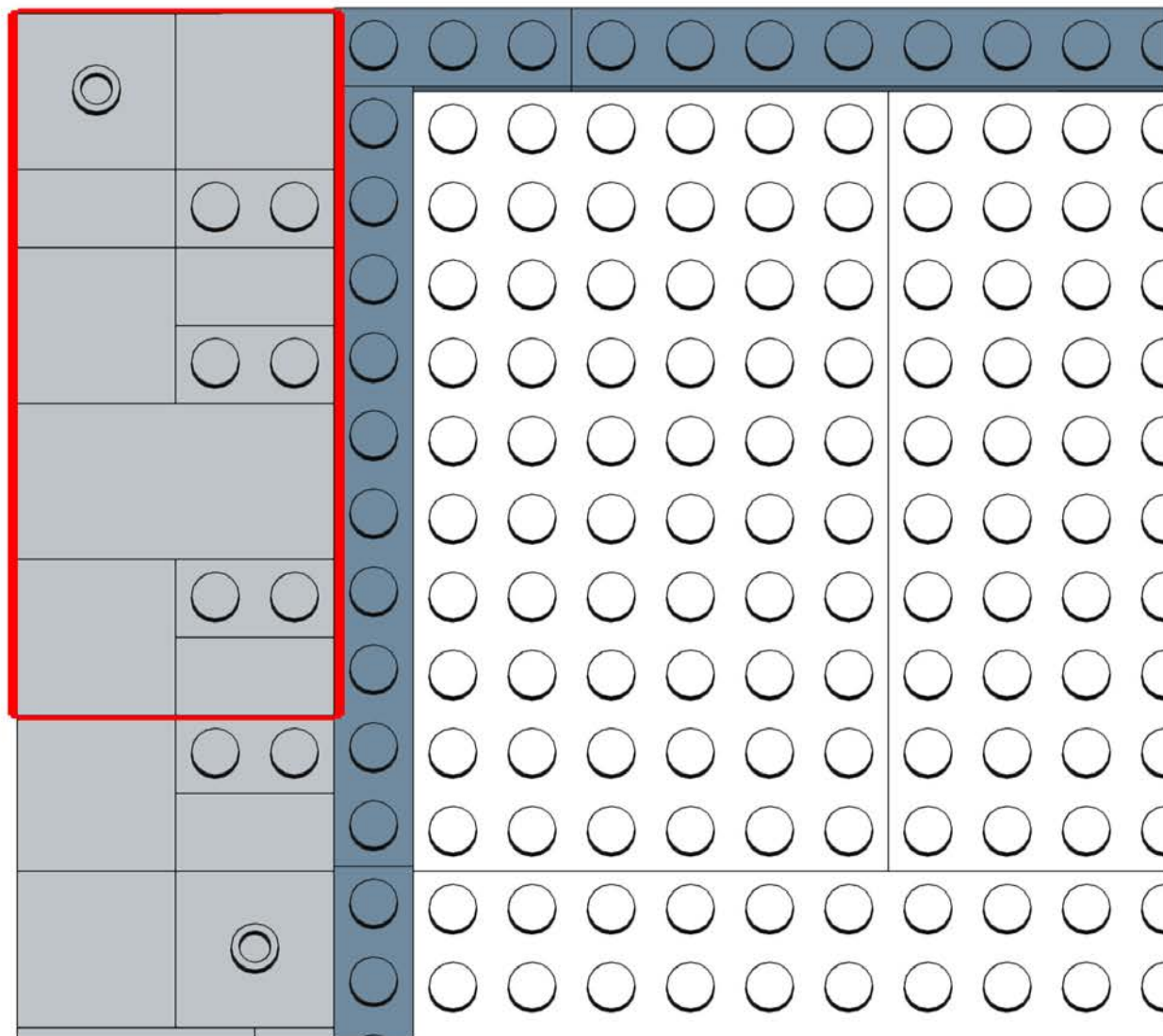
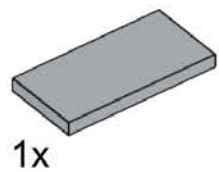
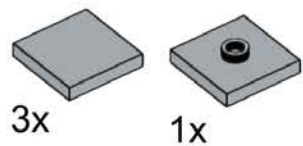
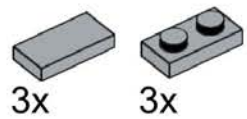

# 30

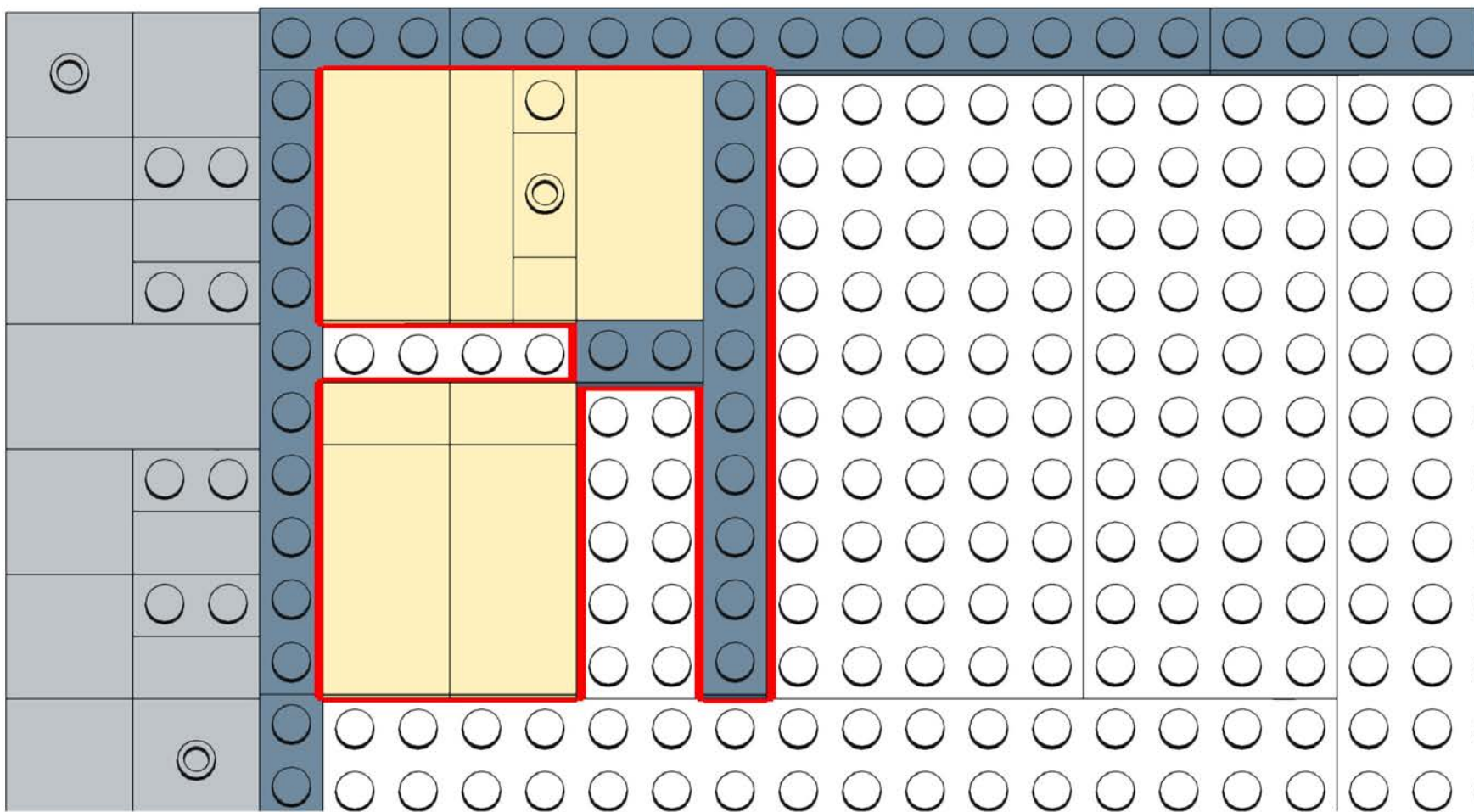
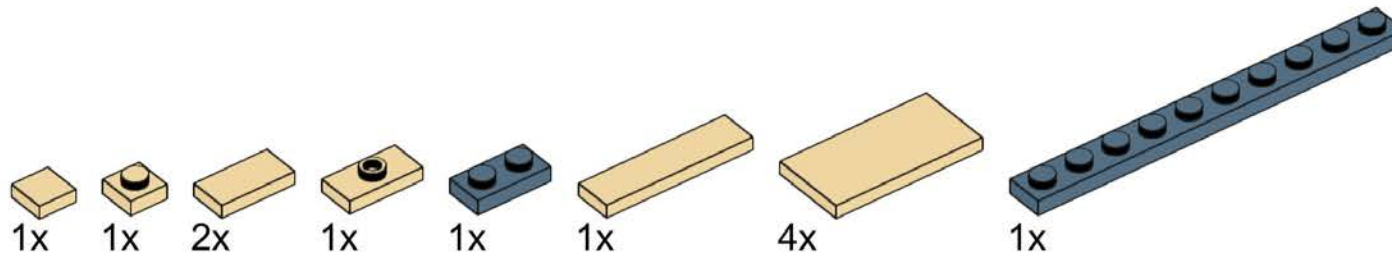

# 31

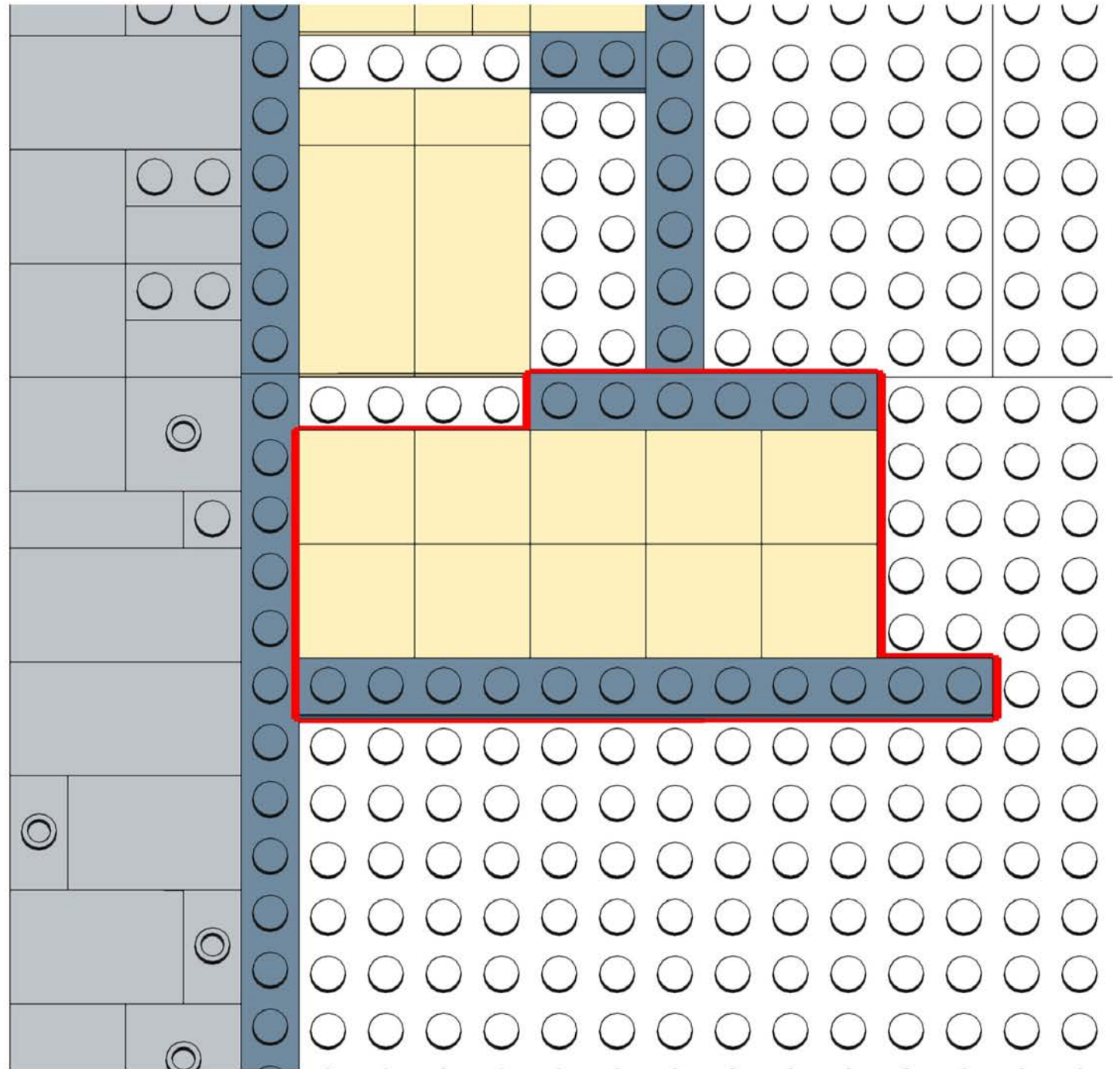
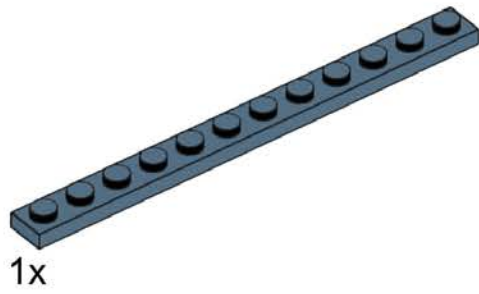
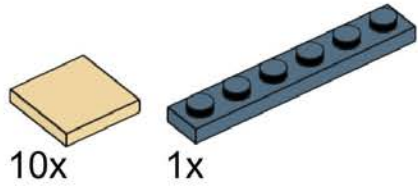



# 32

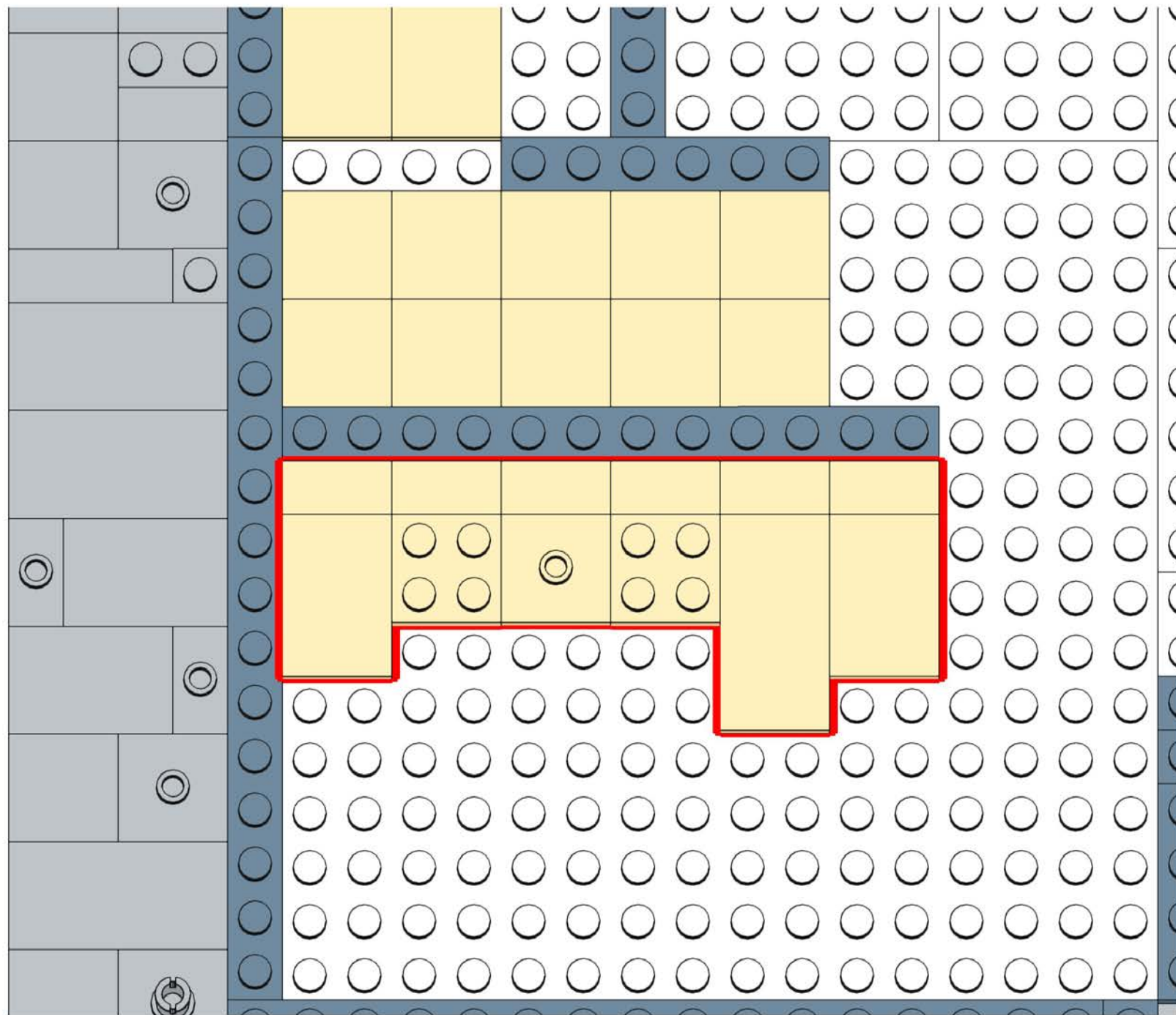
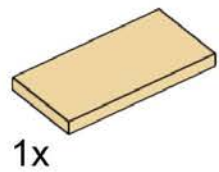
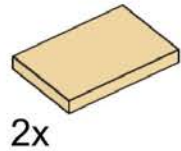
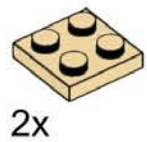
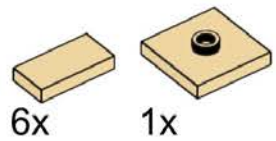

# 33

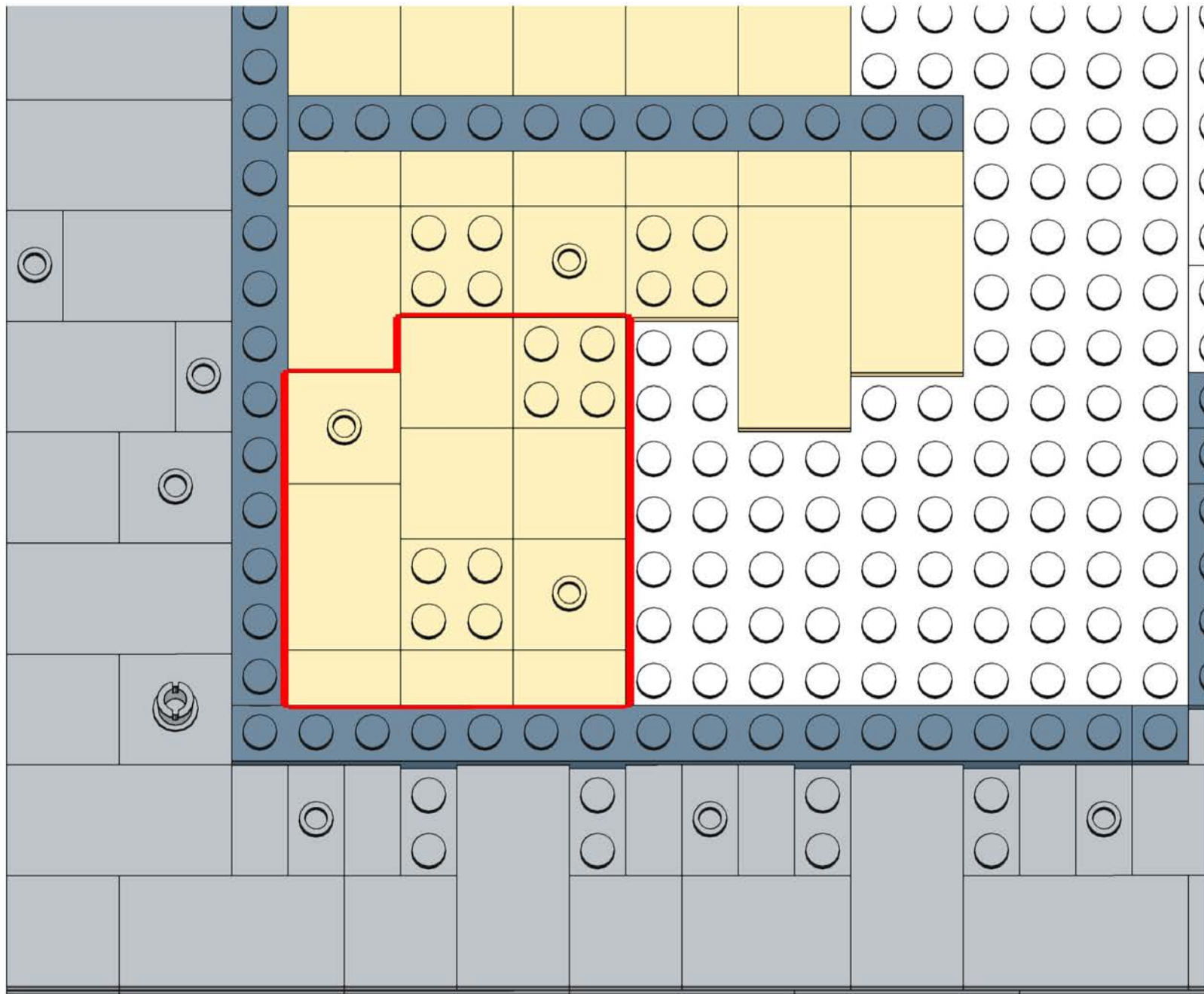
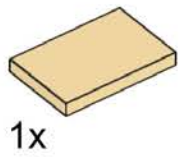
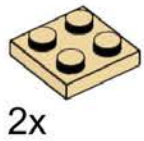
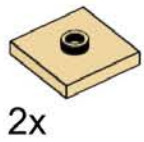
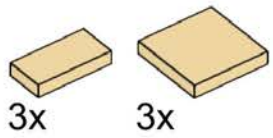

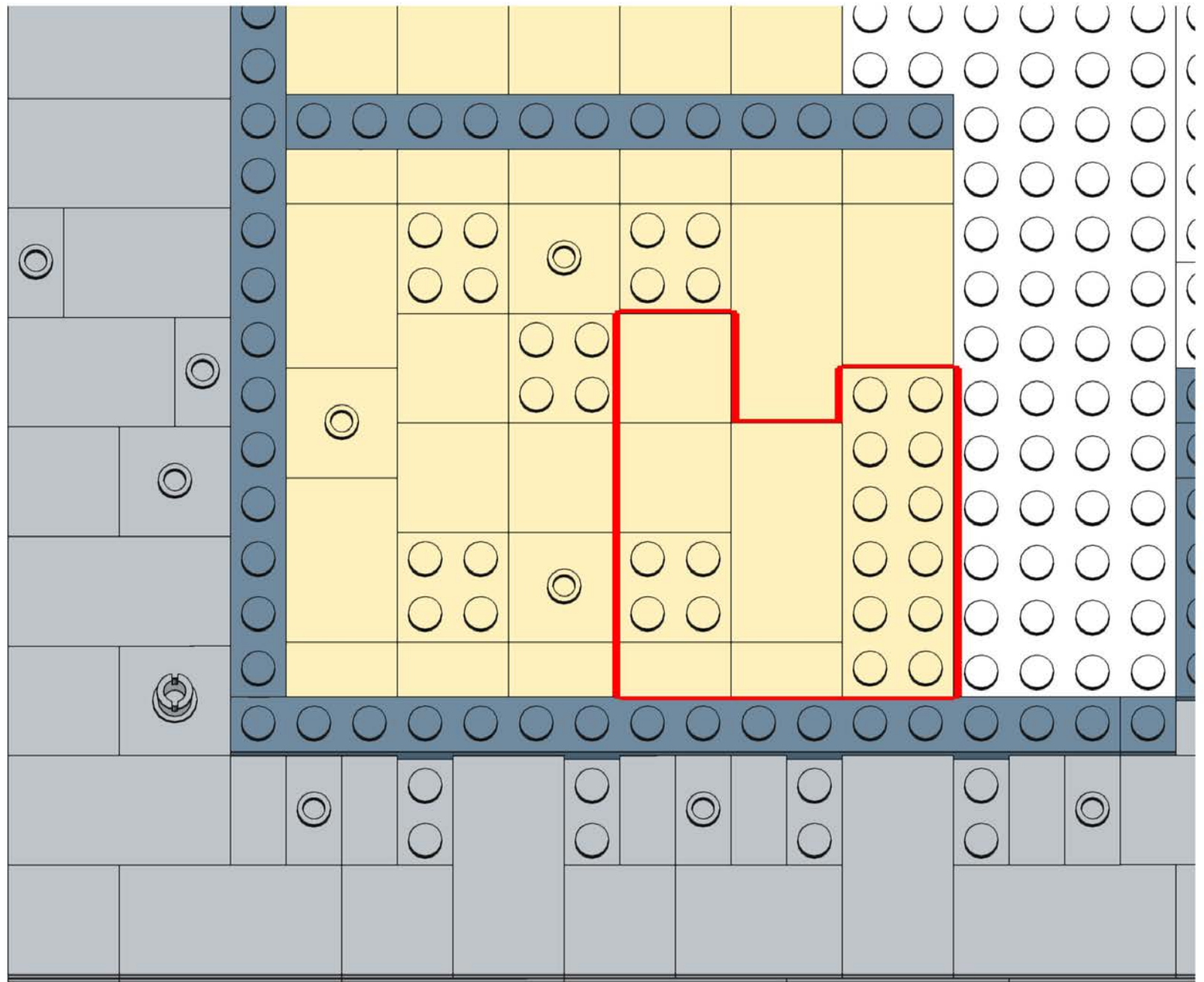
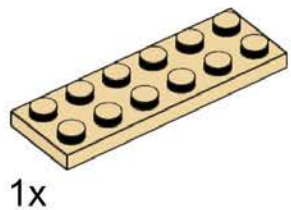
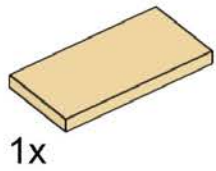
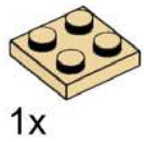
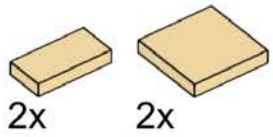

# 34

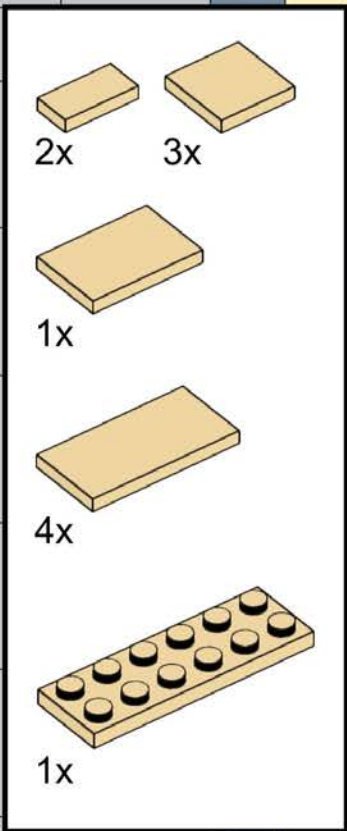

# 35



2x  3x 

1x 

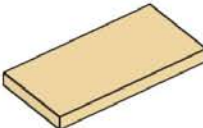
4x 

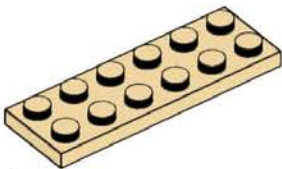
1x 

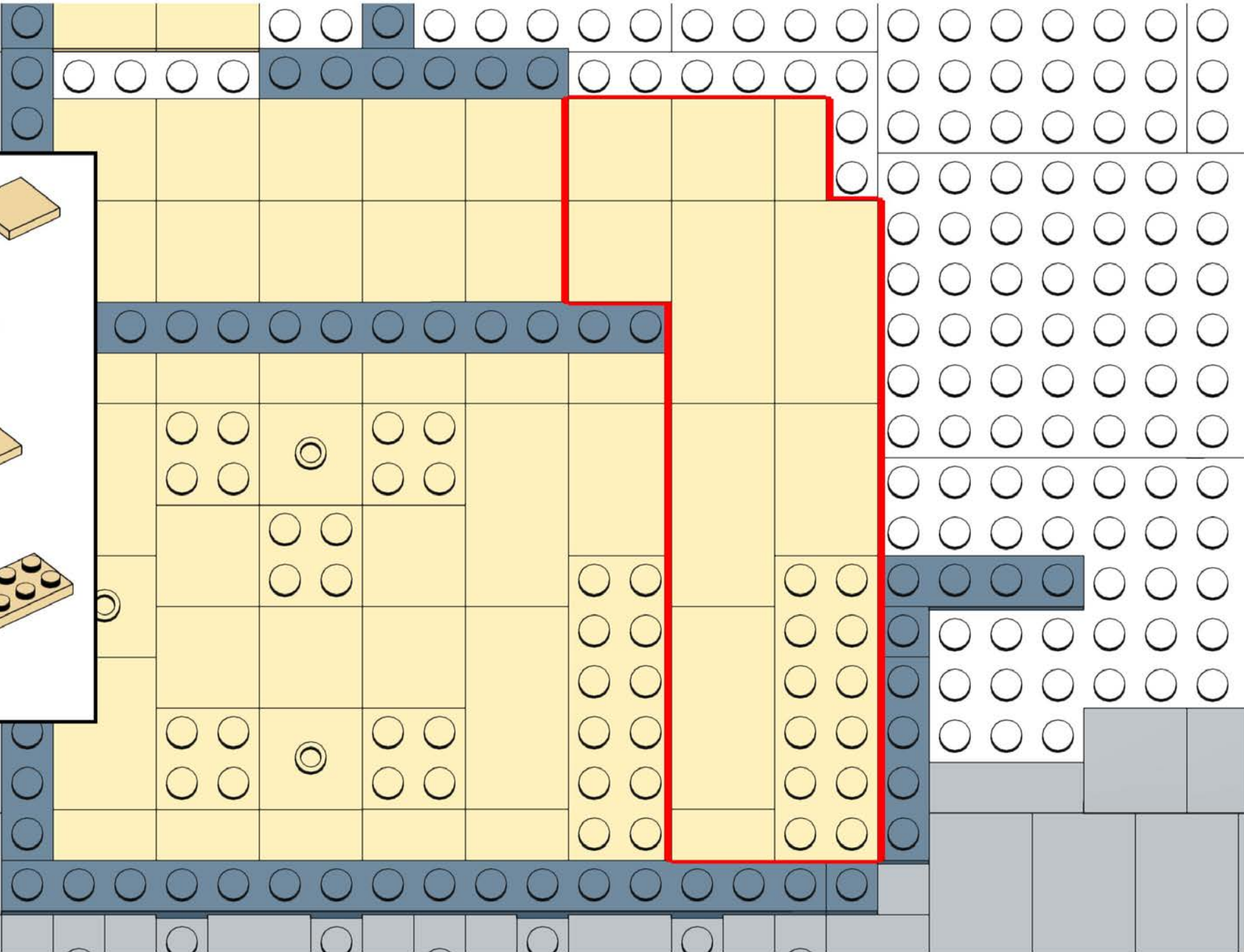

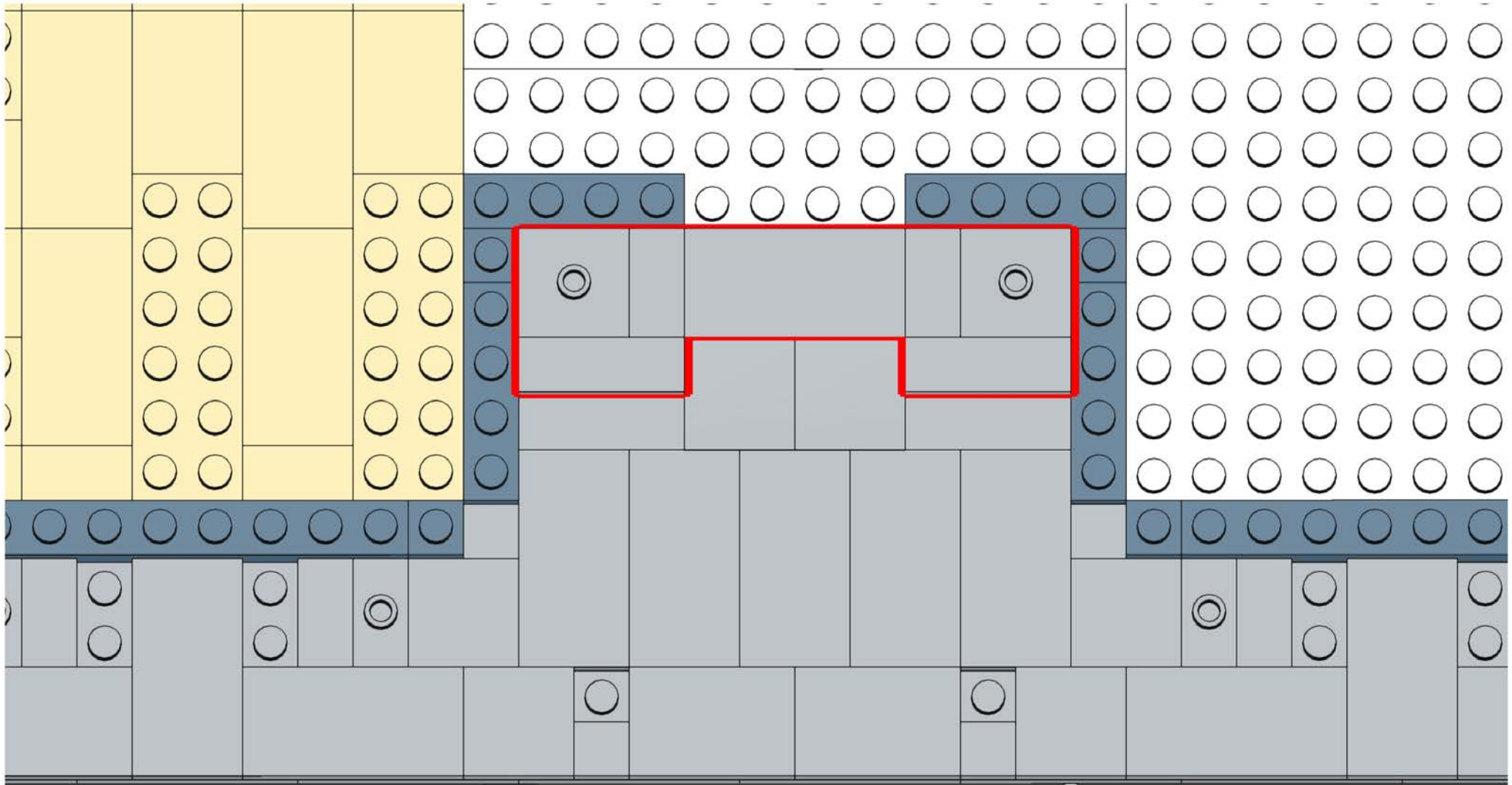

**36**

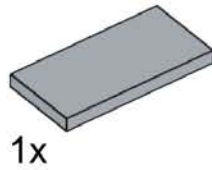
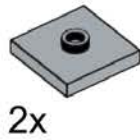
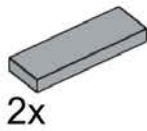
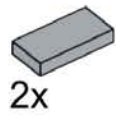

# 37

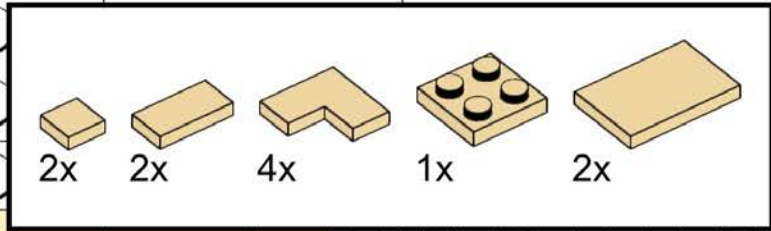

2x 2x 4x 1x 2x

This block contains a parts list for step 37. It includes five items: a 1x2 yellow Technic brick (2x), a 1x3 yellow Technic brick (2x), a 1x3 yellow Technic L-shaped brick (4x), a 1x4 yellow Technic brick with four holes (1x), and a 1x4 yellow Technic flat plate (2x).

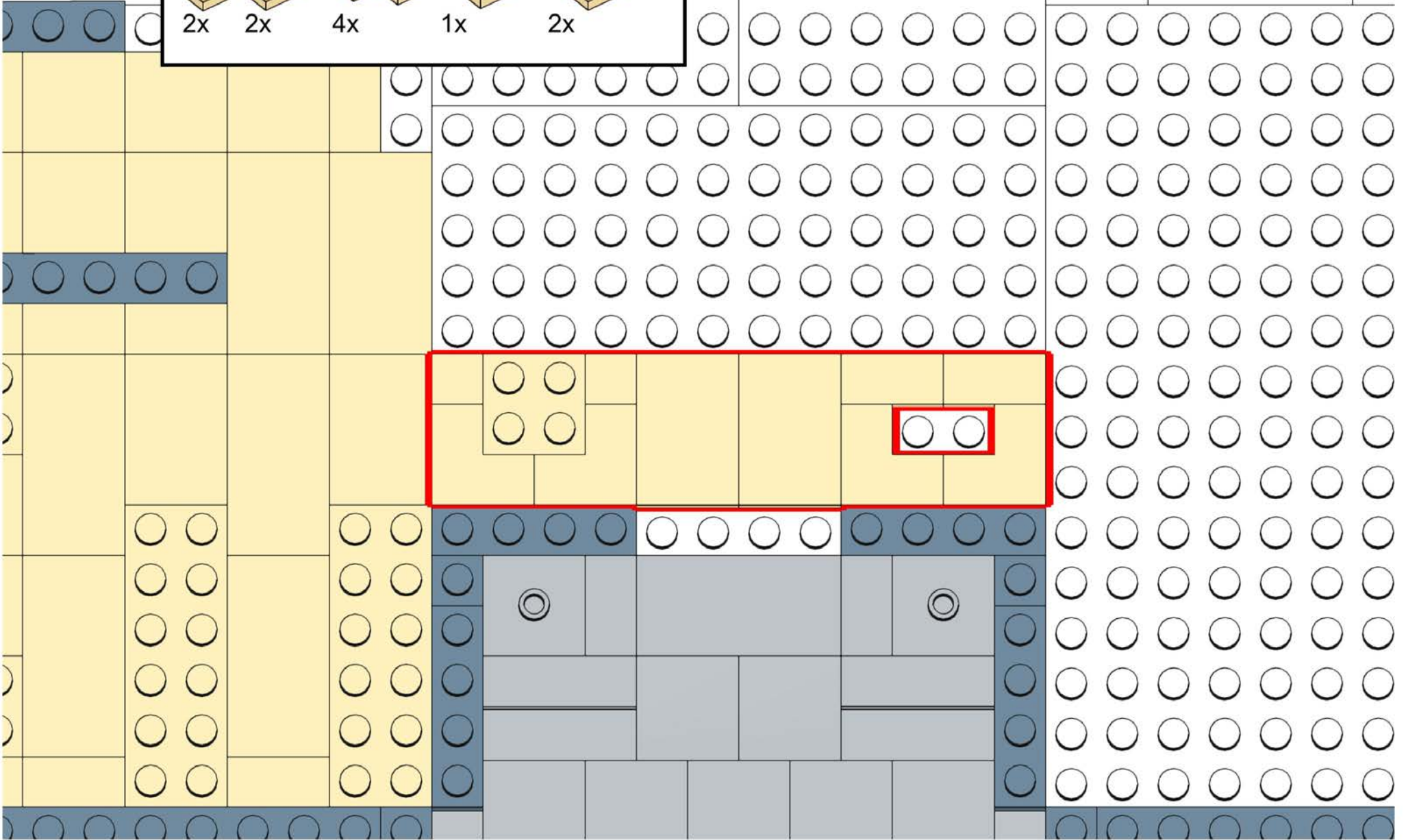

# 38

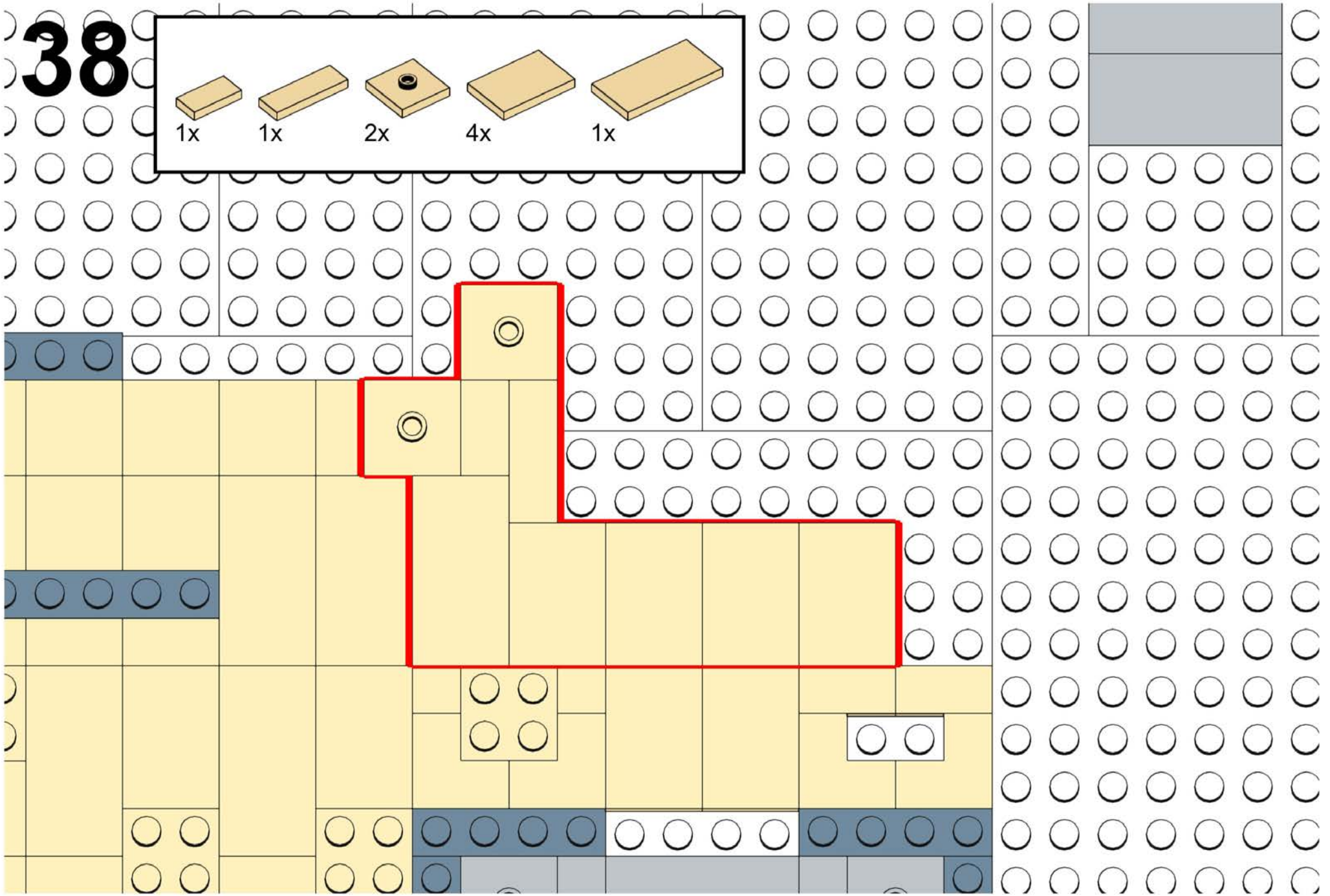
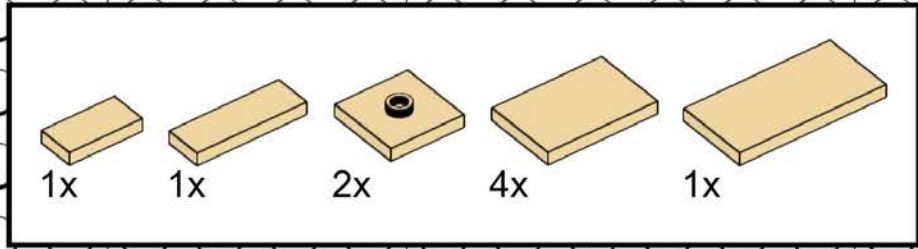

# 39

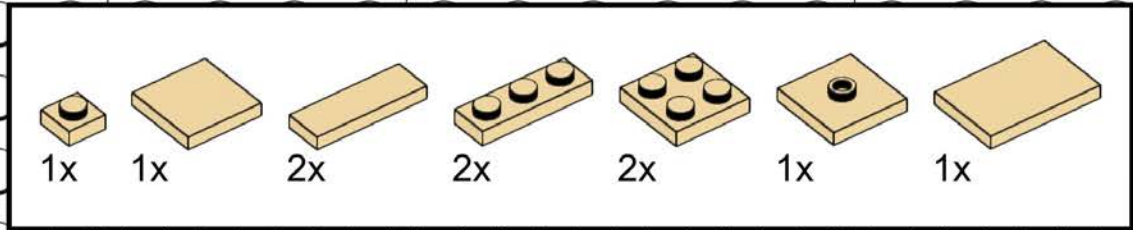

1x 1x 2x 2x 2x 1x 1x

This block contains a list of seven yellow LEGO parts with their respective quantities: 1x 1-hole Technic pin, 1x 1-hole Technic plate, 2x 1-hole Technic Technic beam, 2x 1-hole Technic Technic beam with 3 holes, 2x 1-hole Technic Technic beam with 4 holes, 1x 1-hole Technic Technic plate with 1 hole, and 1x 1-hole Technic Technic plate with 2 holes.

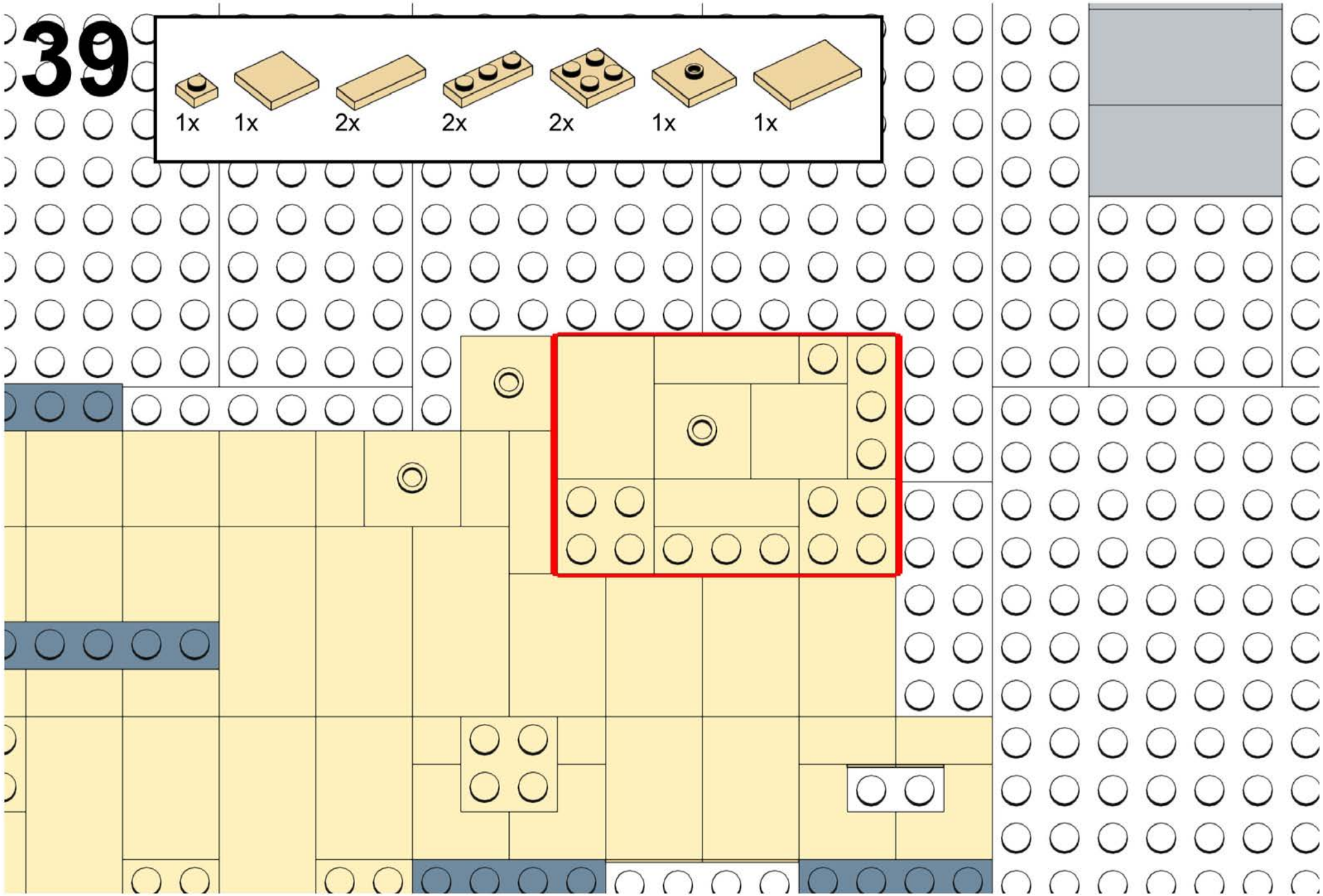



# 40

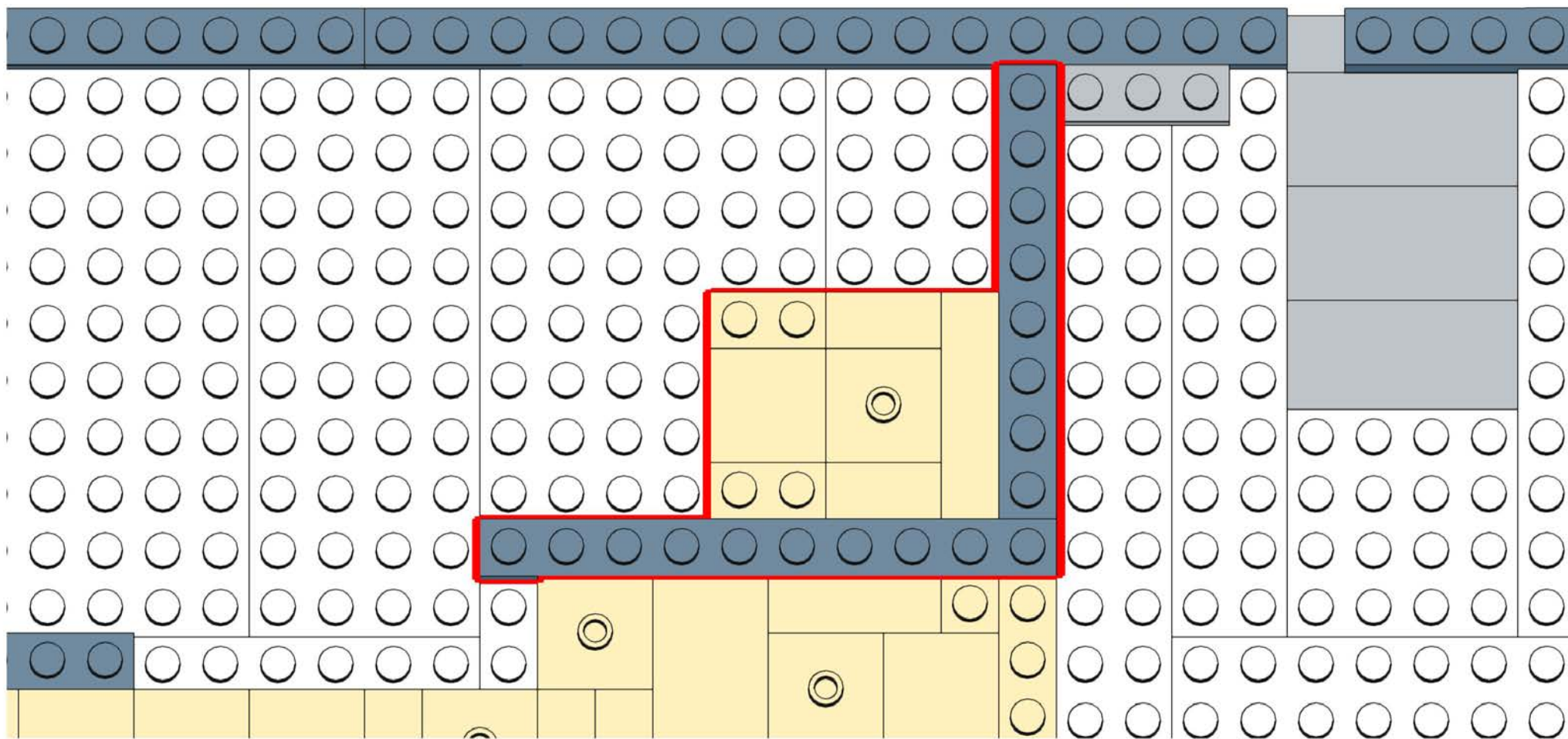
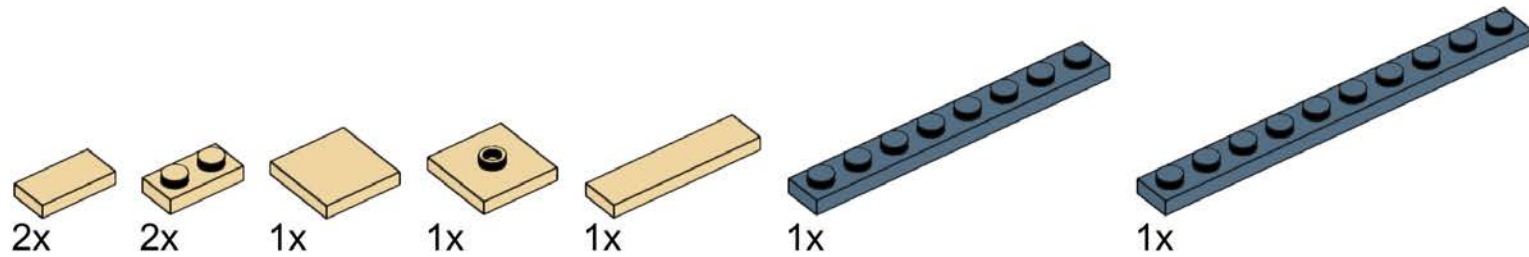

# 41

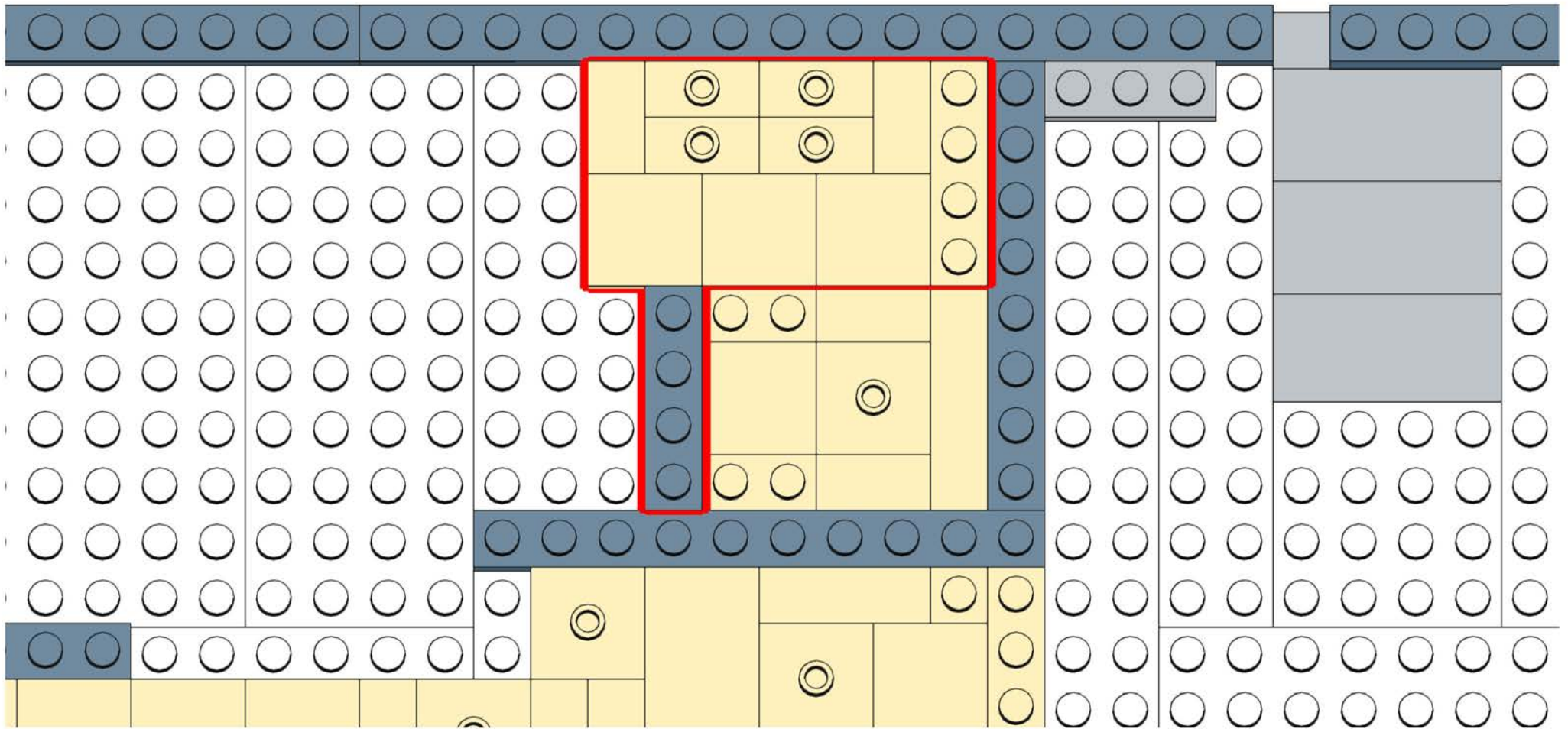
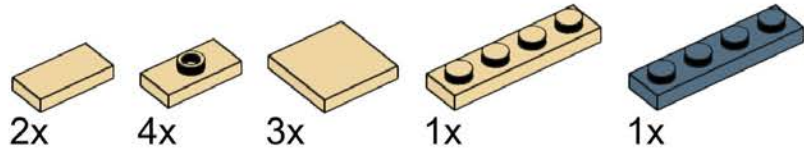

# 42

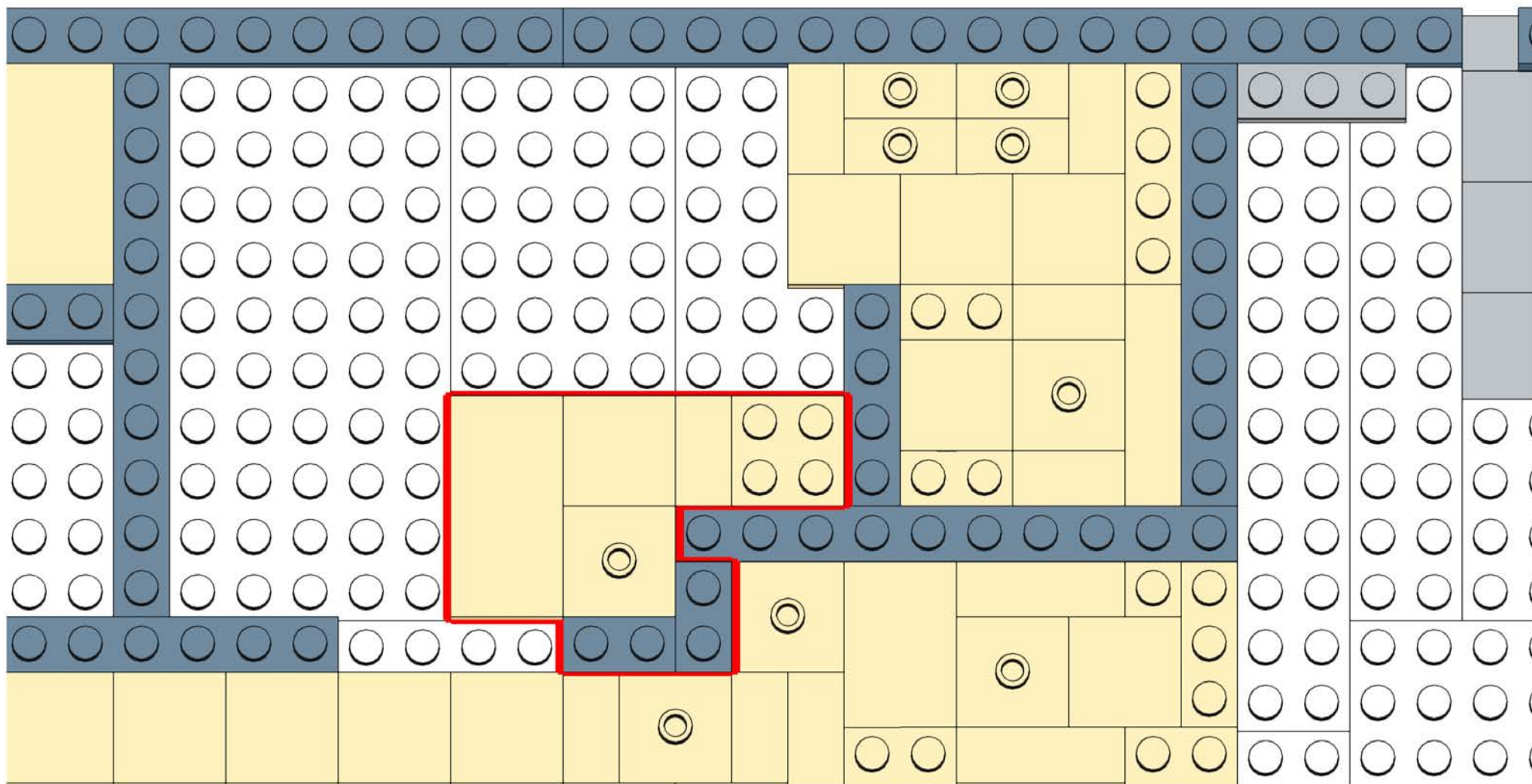
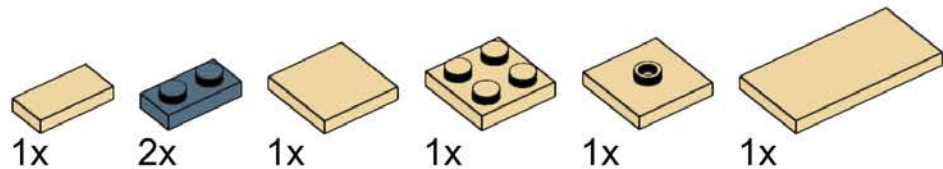

# 43

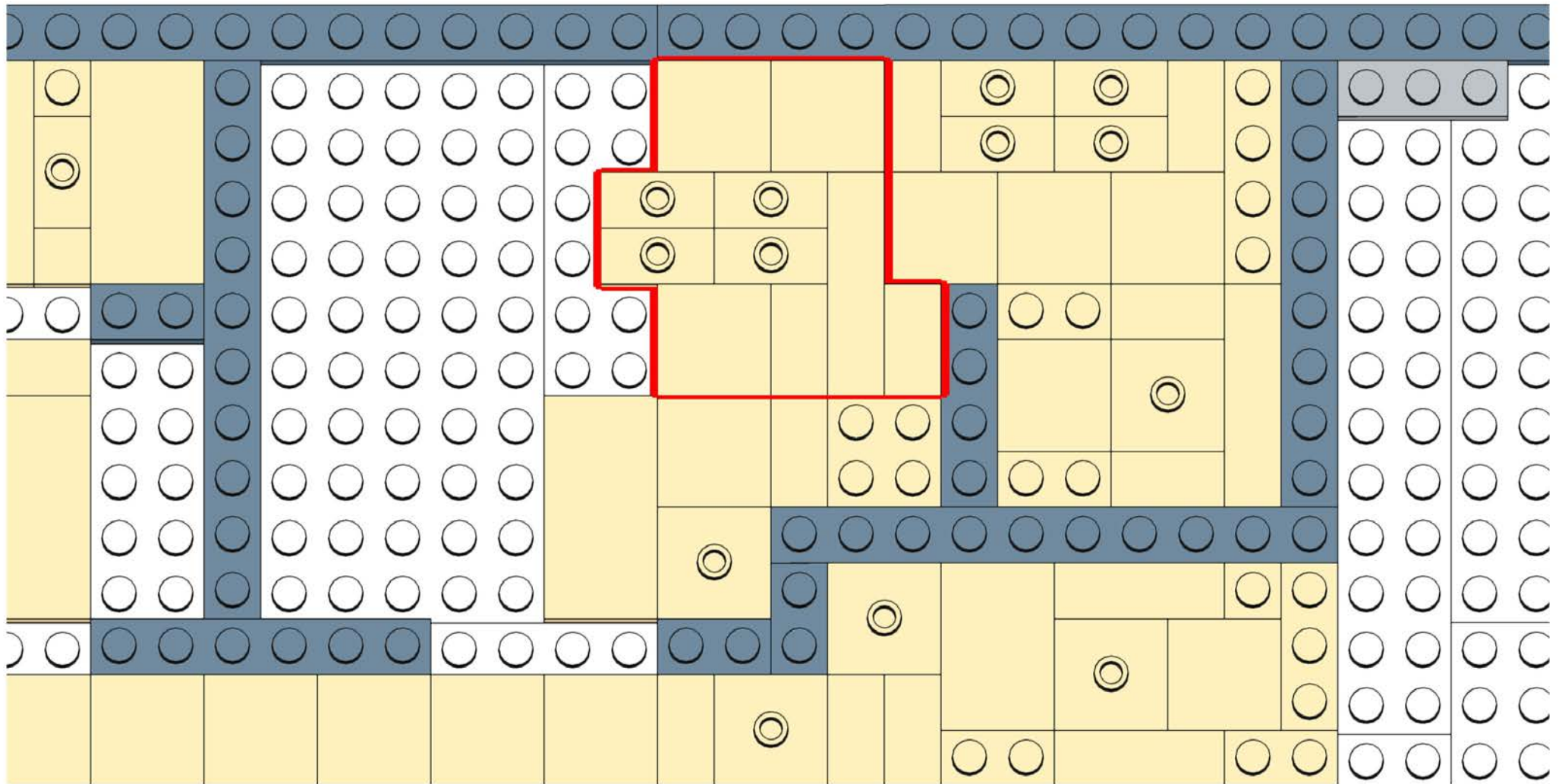
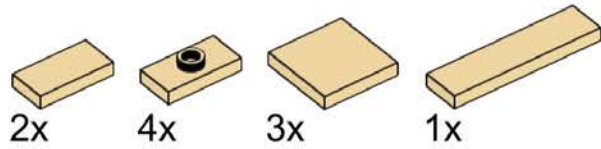

# 44

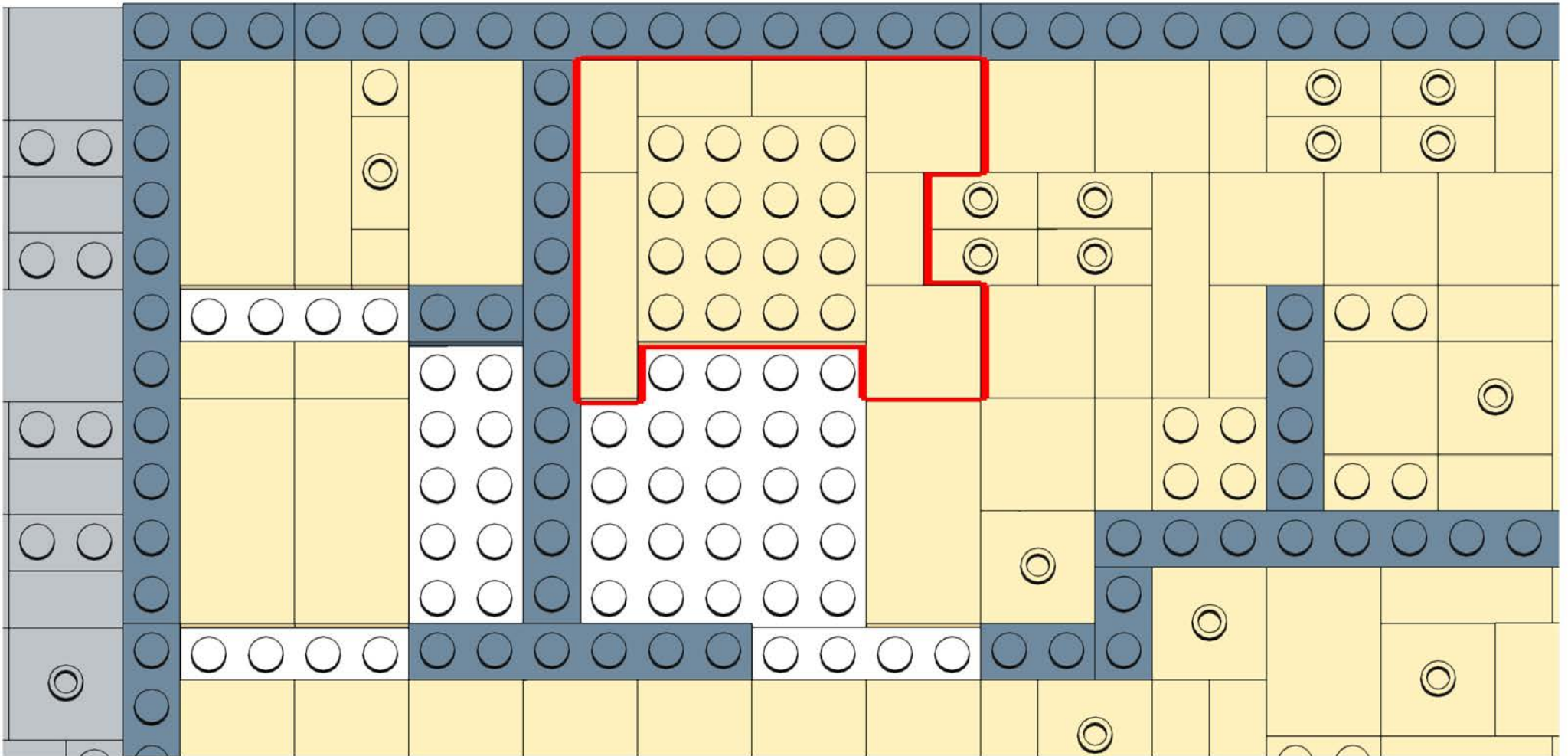
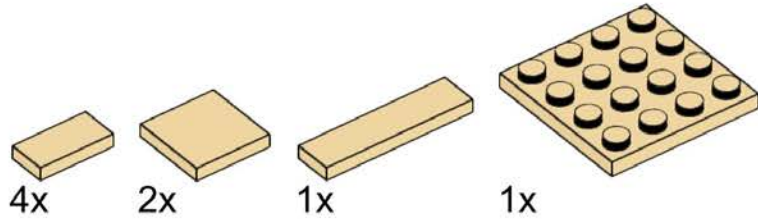

# 45

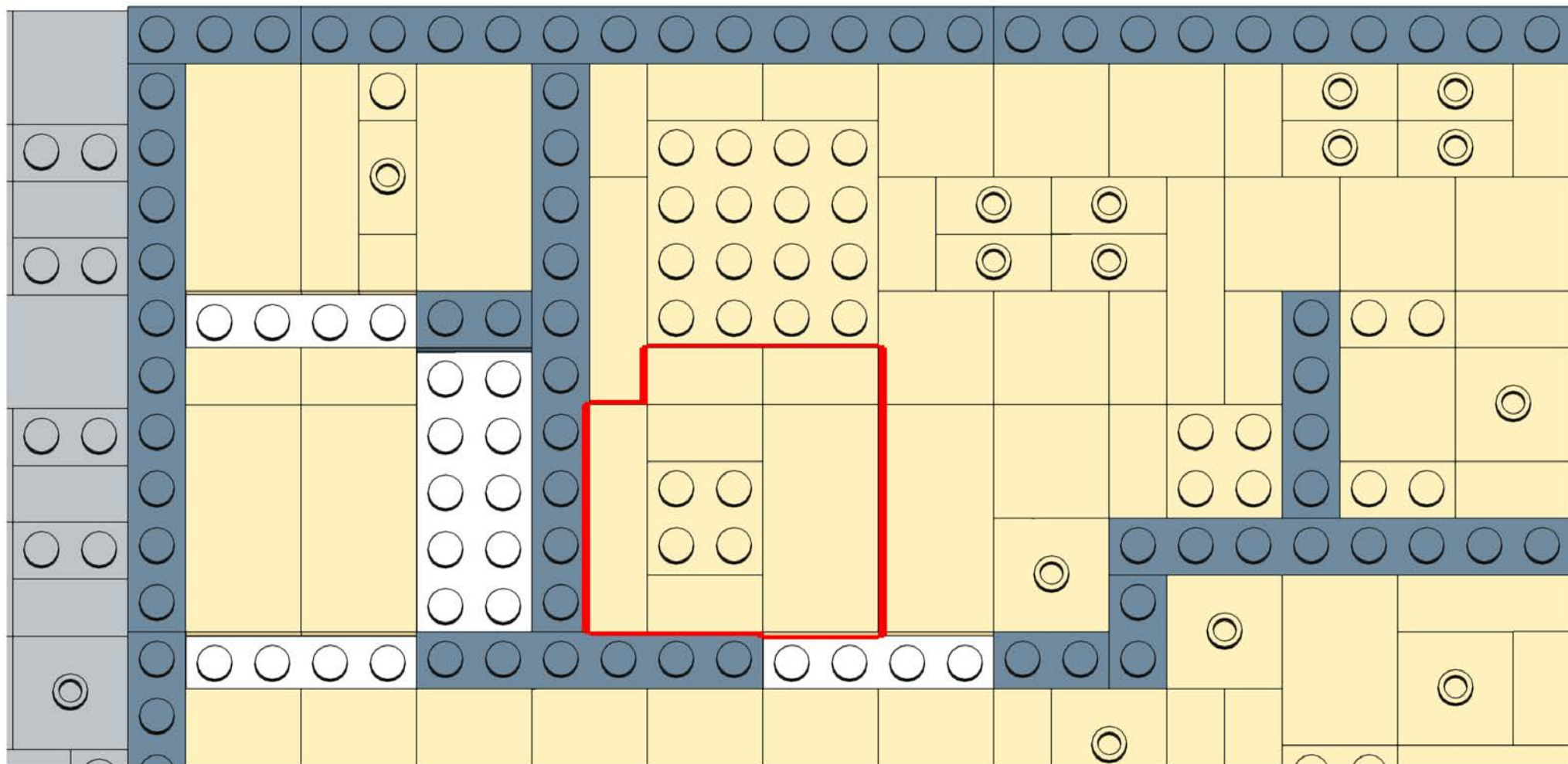
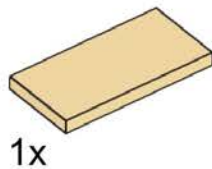
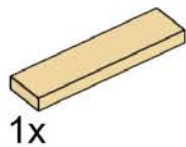
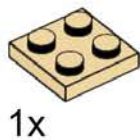
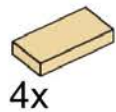

# 46

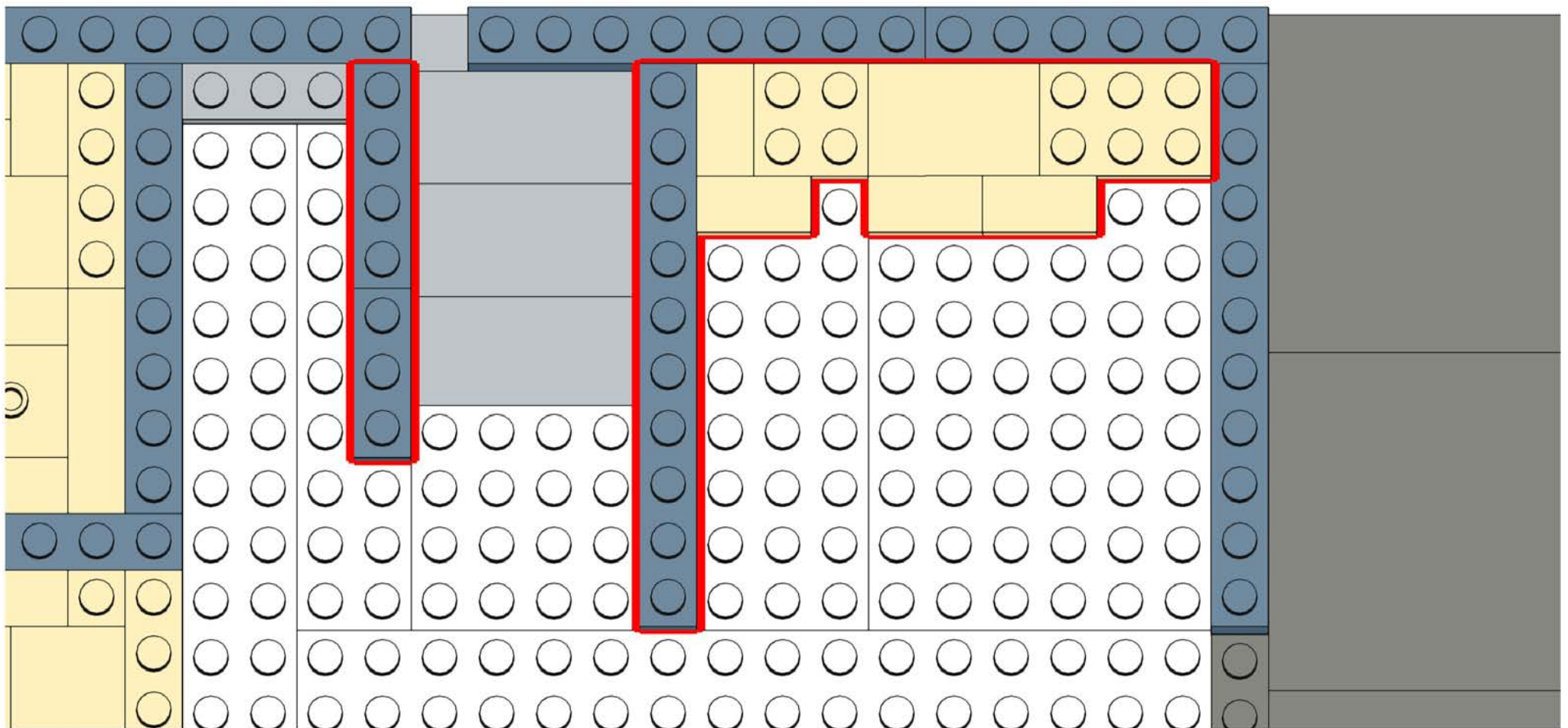
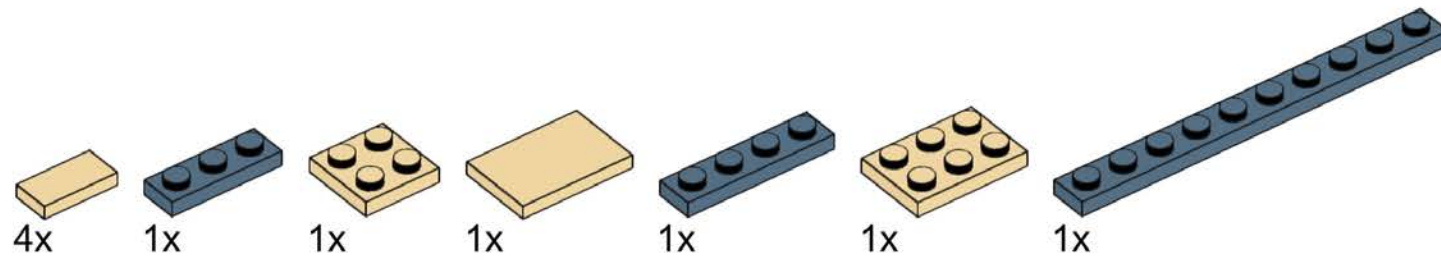

# 47

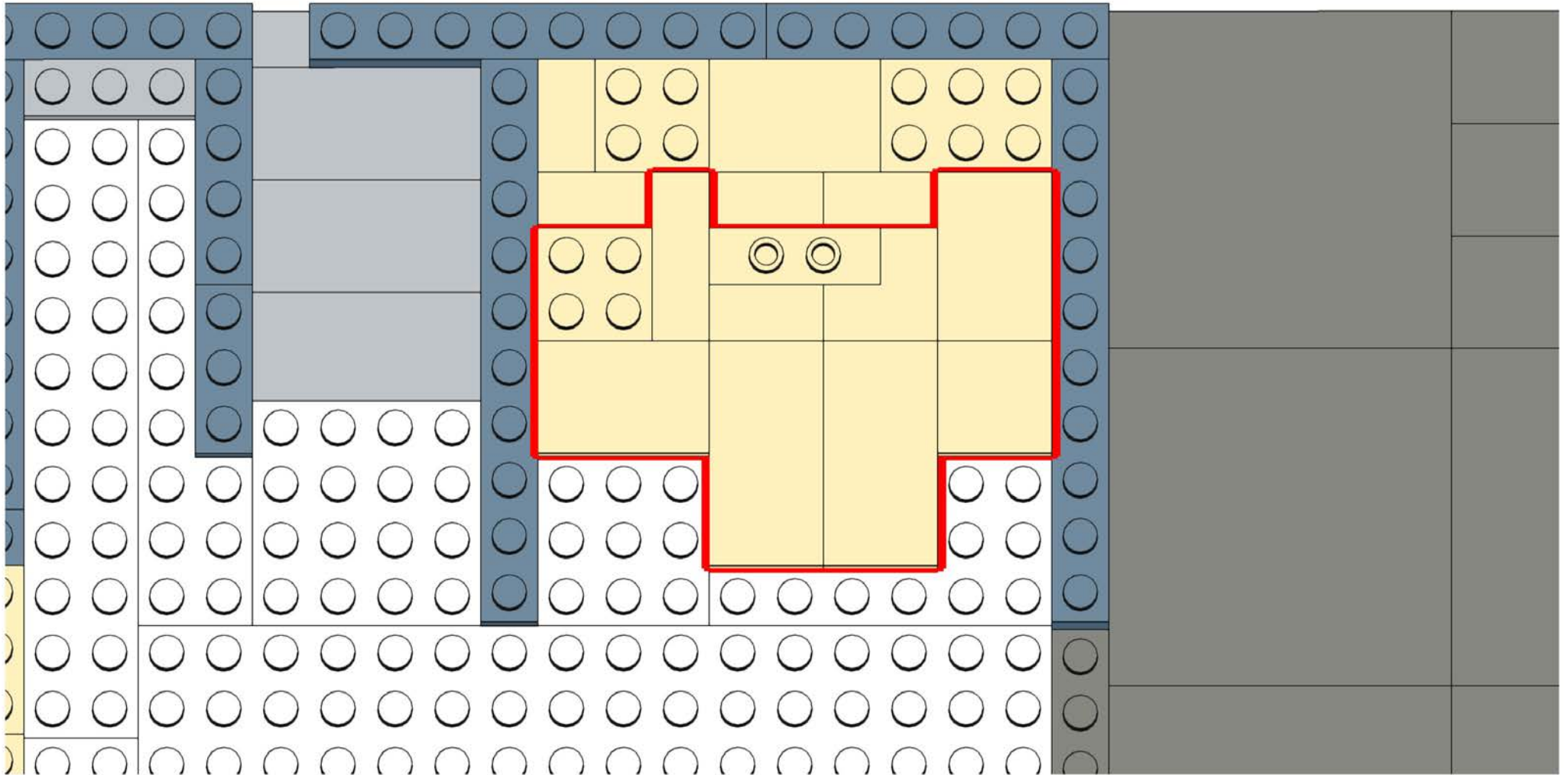
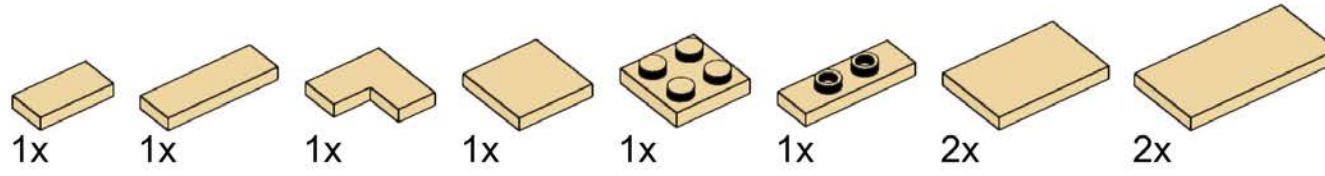



# 48

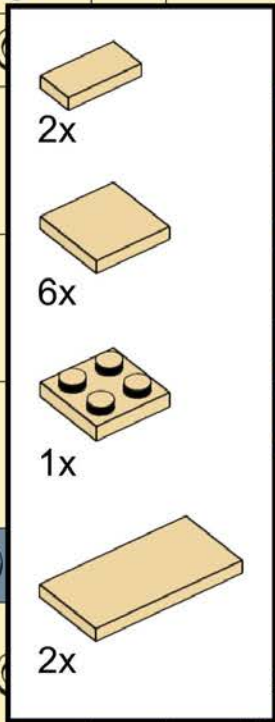

2x  
6x  
1x  
2x

This list shows four types of tan-colored LEGO Technic parts: a 1x3 Technic brick (2x), a 1x4 Technic brick (6x), a 1x4 Technic brick with four holes (1x), and a 1x6 Technic brick (2x).

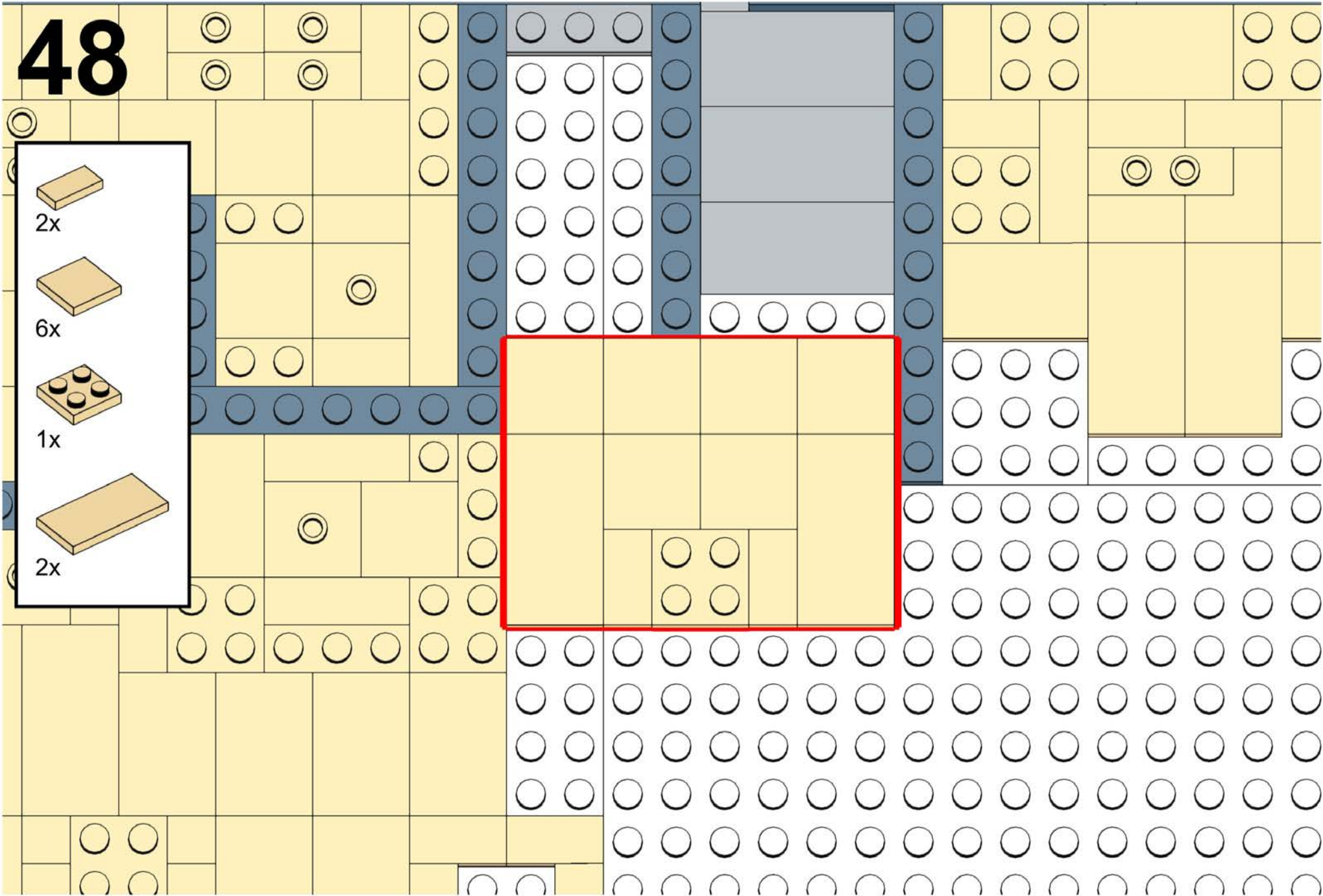
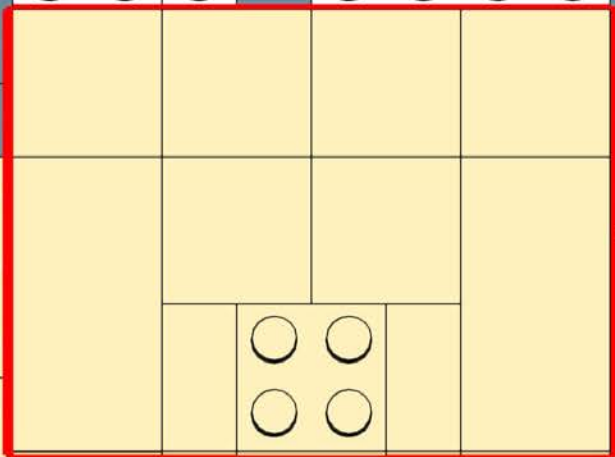

# 49

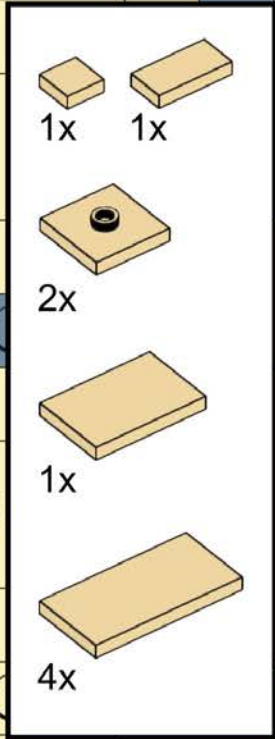

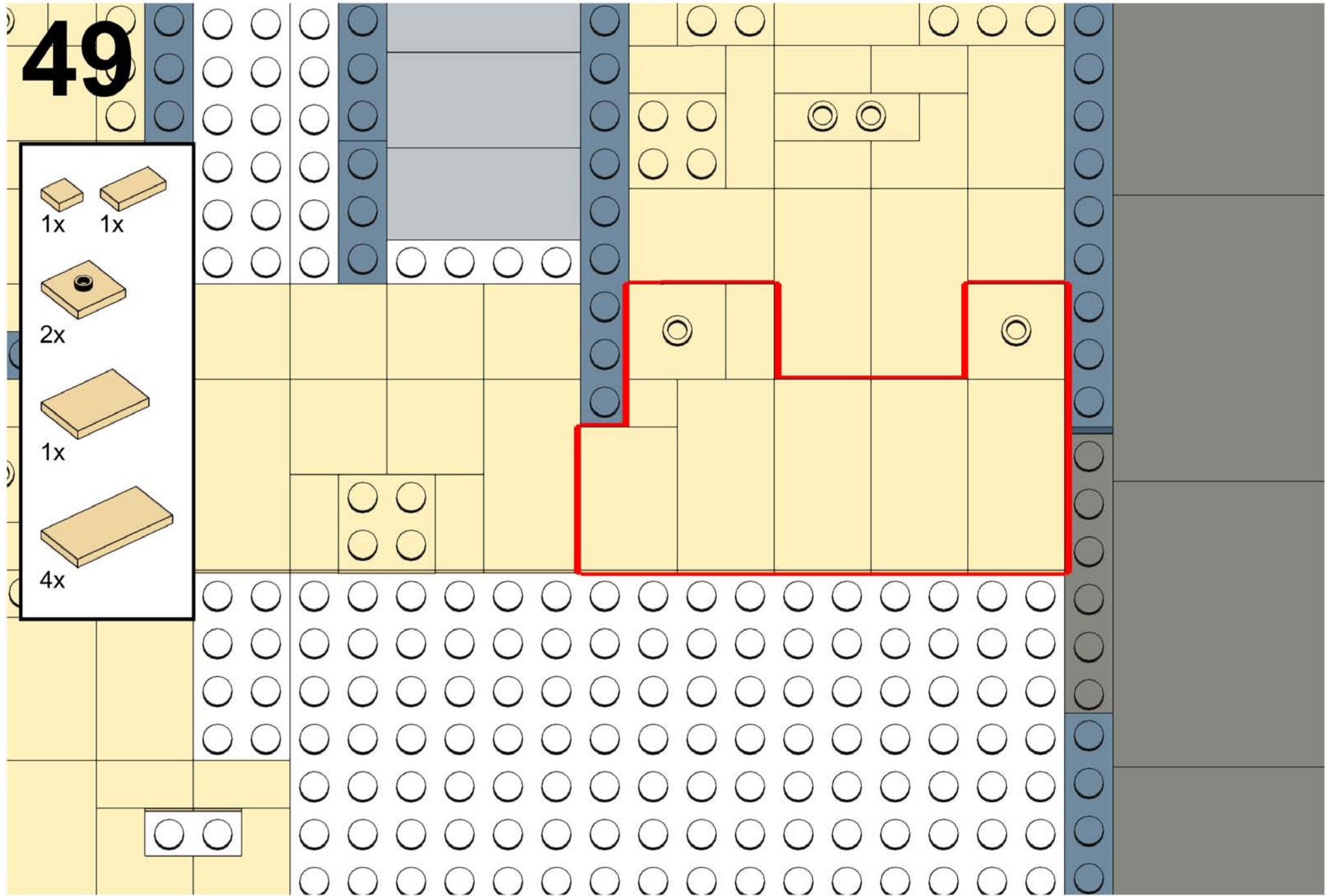

1x 1x  
1x 1x  
2x  
1x  
4x

The parts list shows four items: a 1x1 tan Technic brick, a 1x2 tan Technic brick, a 2x2 tan Technic brick with a black axle hole in the center, a 1x3 tan Technic brick, and a 1x4 tan Technic brick.



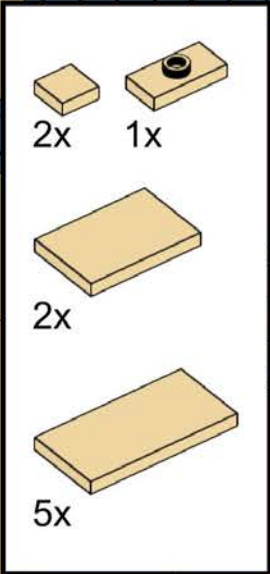

# 50

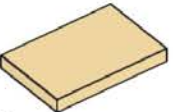

2x  

1x 

2x 

5x 

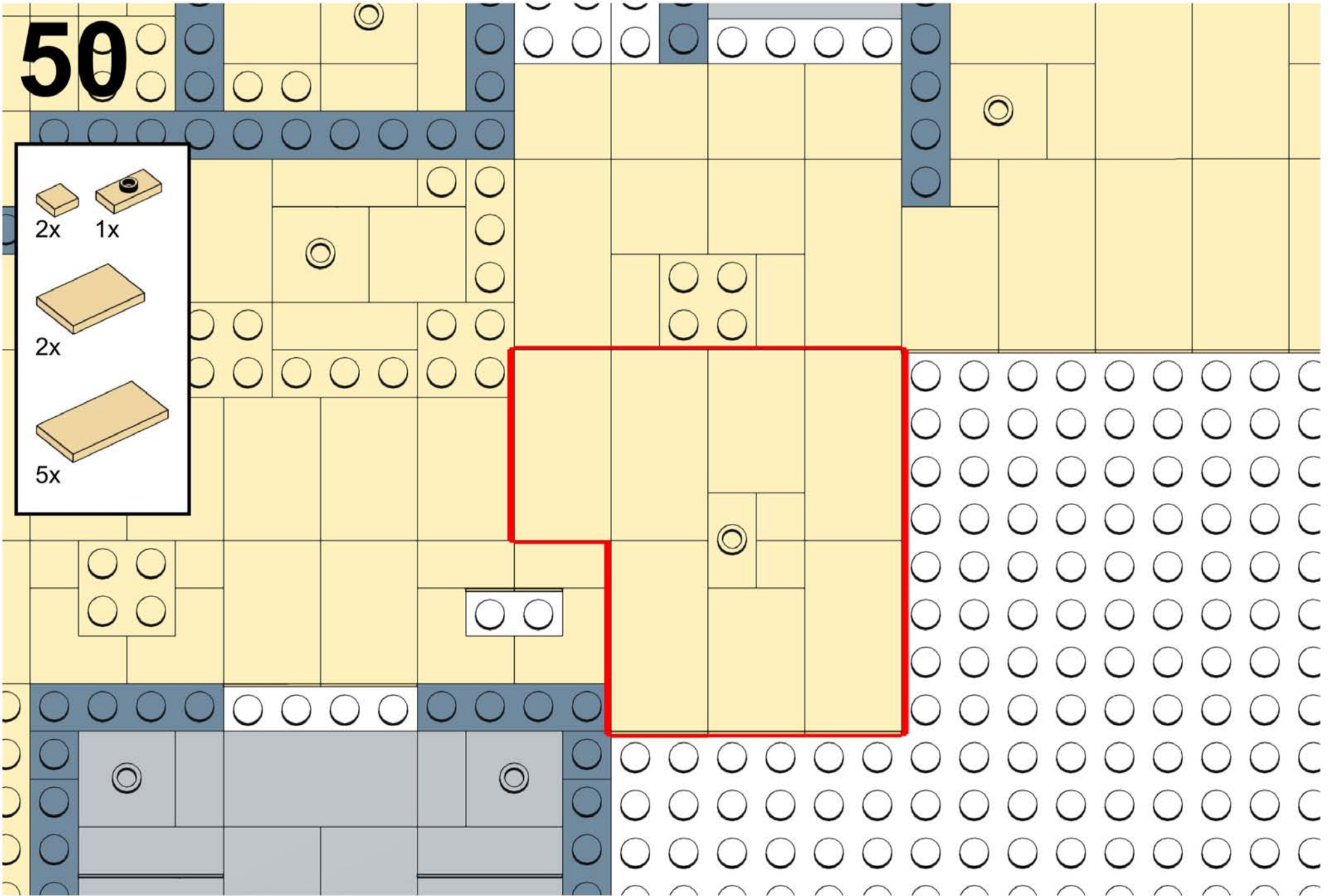

# 51

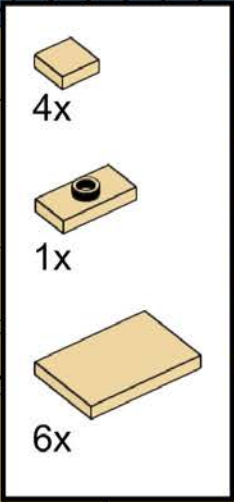



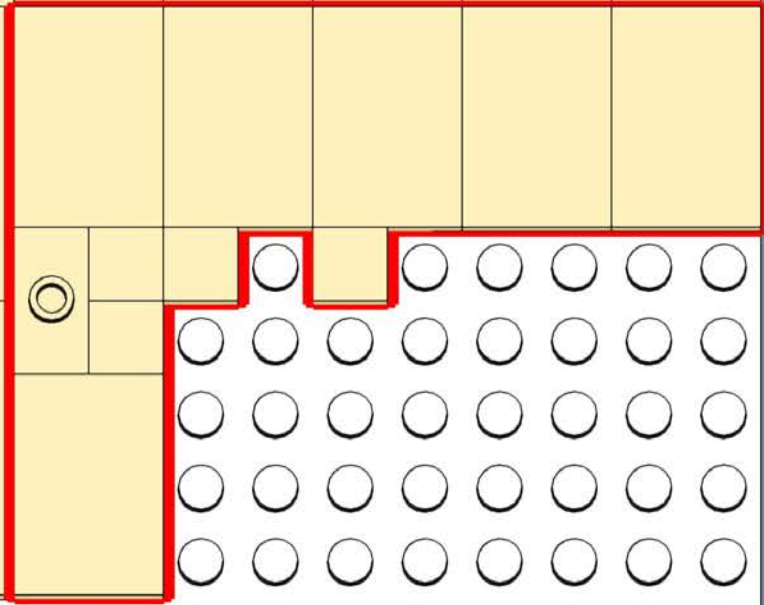

4x  
1x  
6x

This block contains a list of parts for step 51. It includes three items: a 1x2 tan Technic brick (4x), a 1x2 tan Technic brick with a black axle hole (1x), and a 1x6 tan Technic brick (6x).

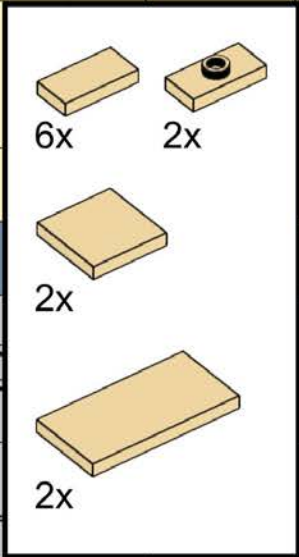

# 52



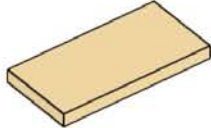

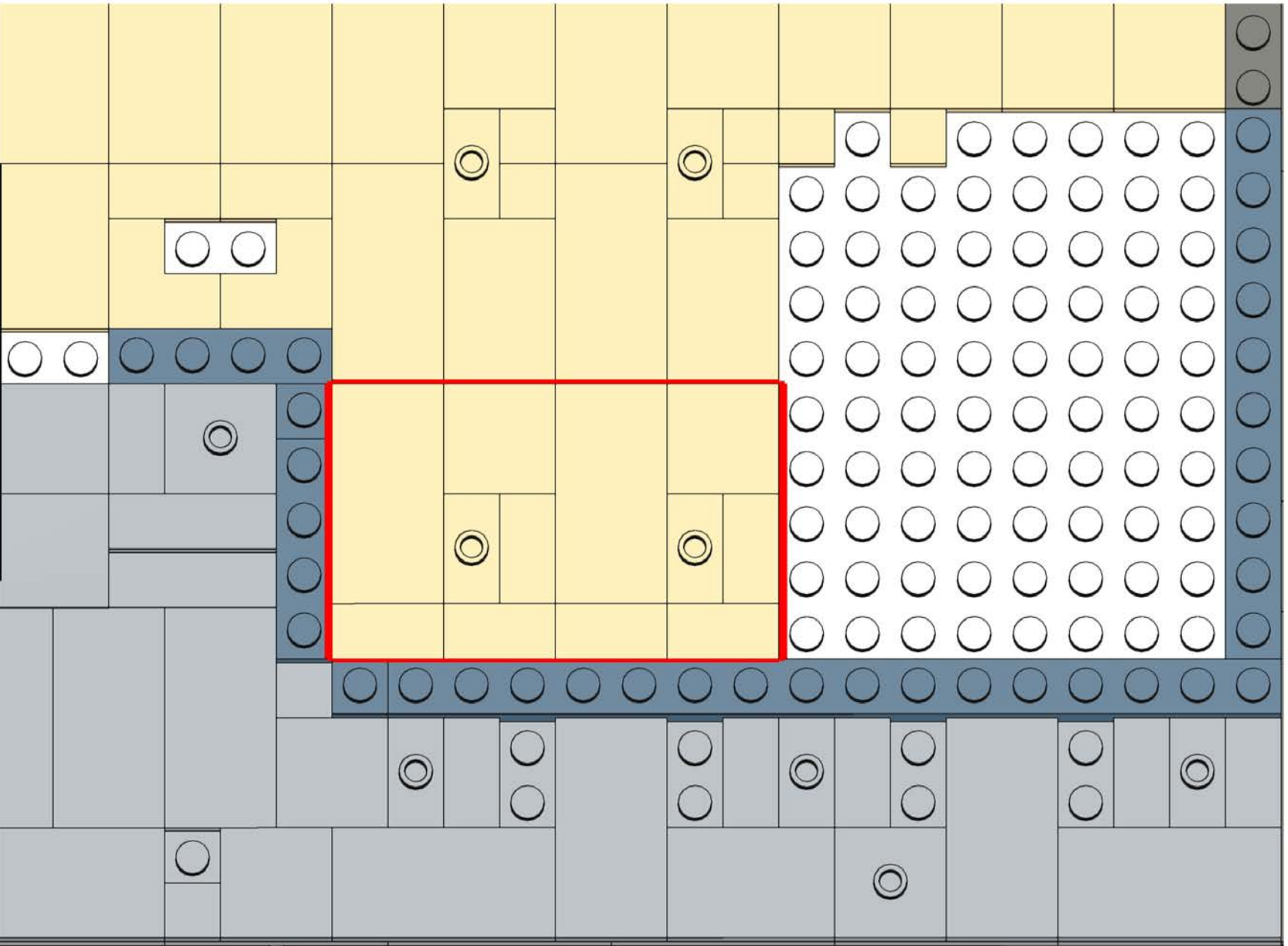
6x  2x   
2x   
2x 

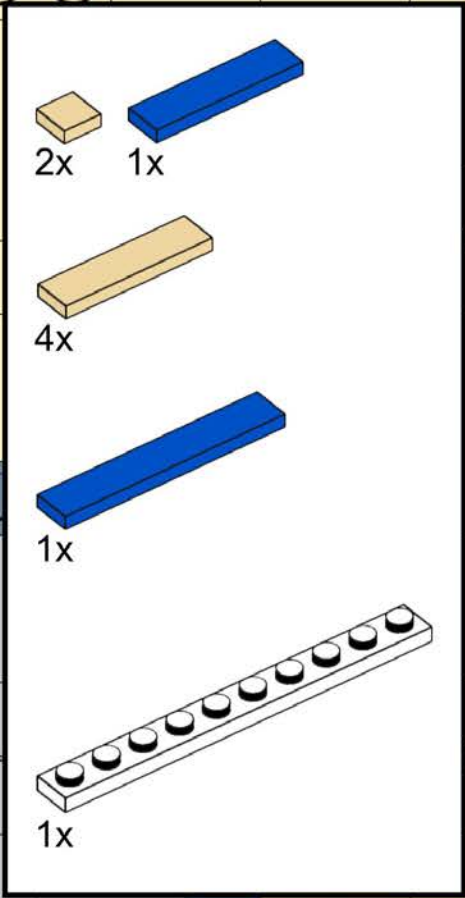

# 53

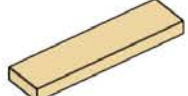

2x  1x 

4x 

1x 

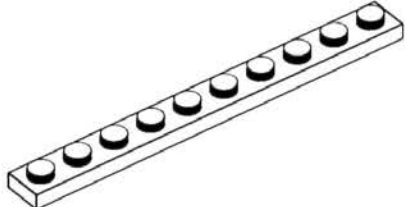
1x 

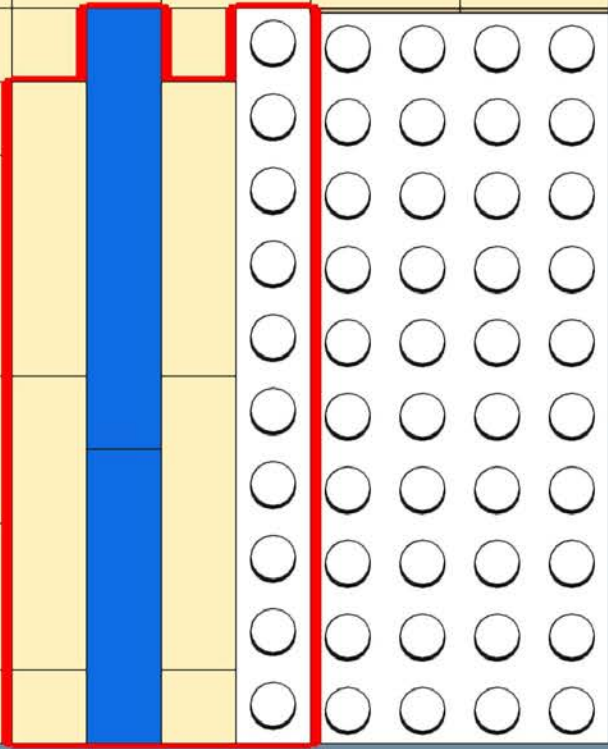

# 54

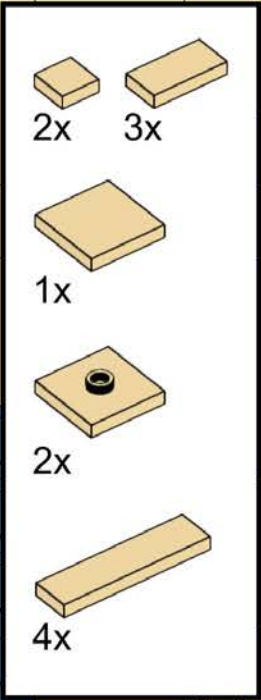

2x 3x

1x

2x

4x

Detailed description: A white rectangular box containing four items. The first row shows two small 1x2 tan Technic bricks, labeled '2x' and '3x' respectively. The second row shows a single 1x4 tan Technic plate, labeled '1x'. The third row shows two 1x4 tan Technic plates with a black axle hole in the center, labeled '2x'. The fourth row shows a single 1x4 tan Technic Technic beam, labeled '4x'.

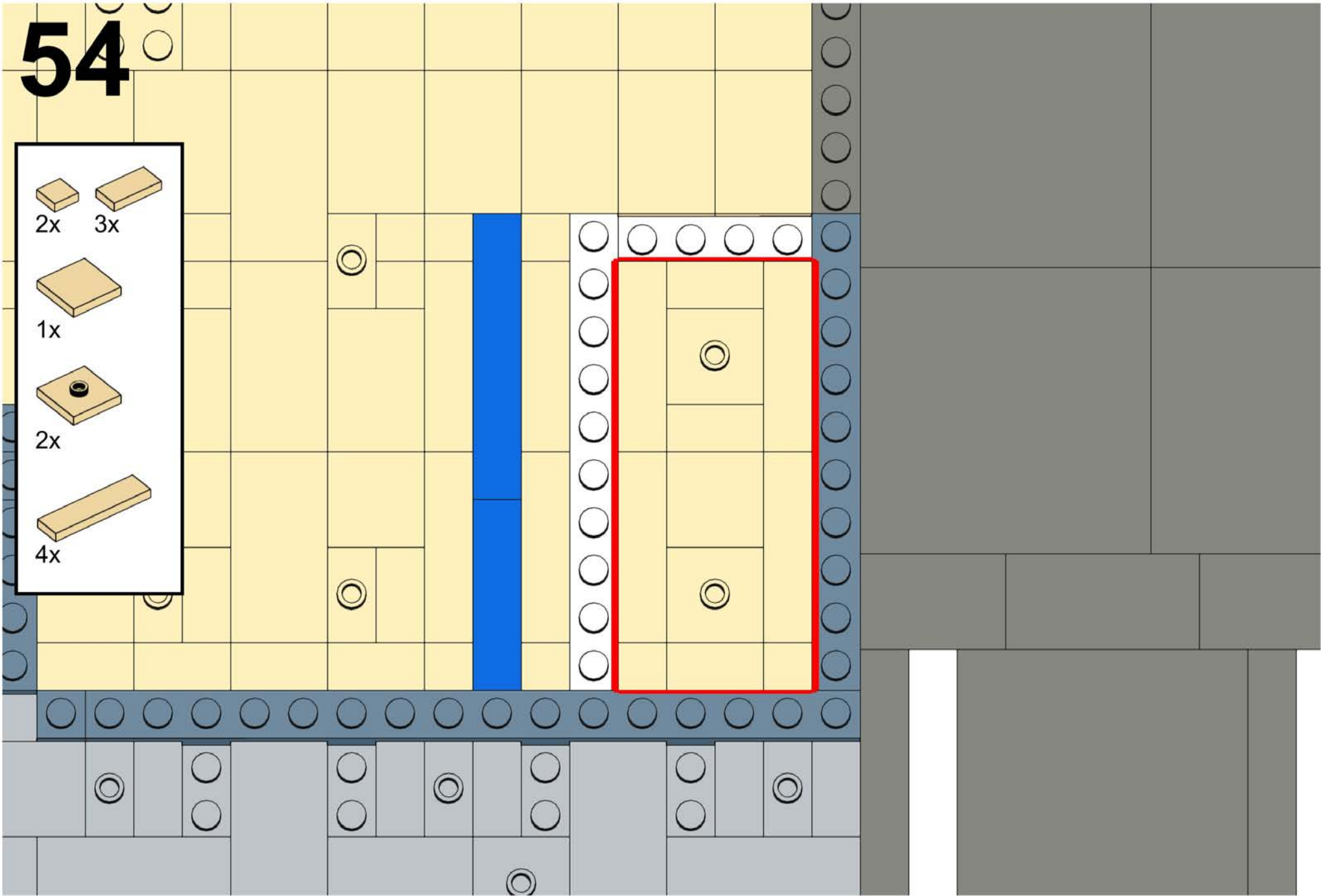

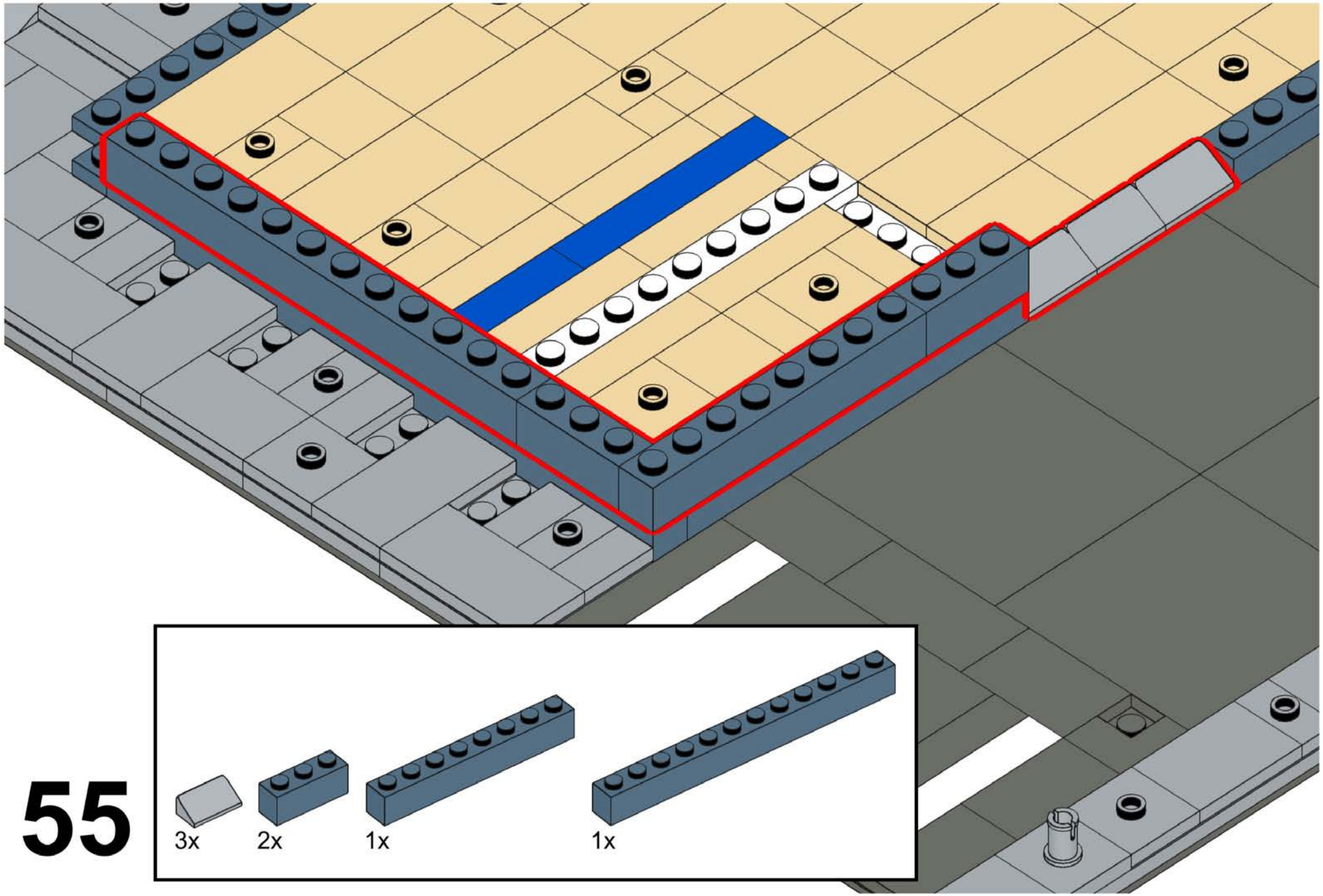

**55**

3x

2x

1x

1x



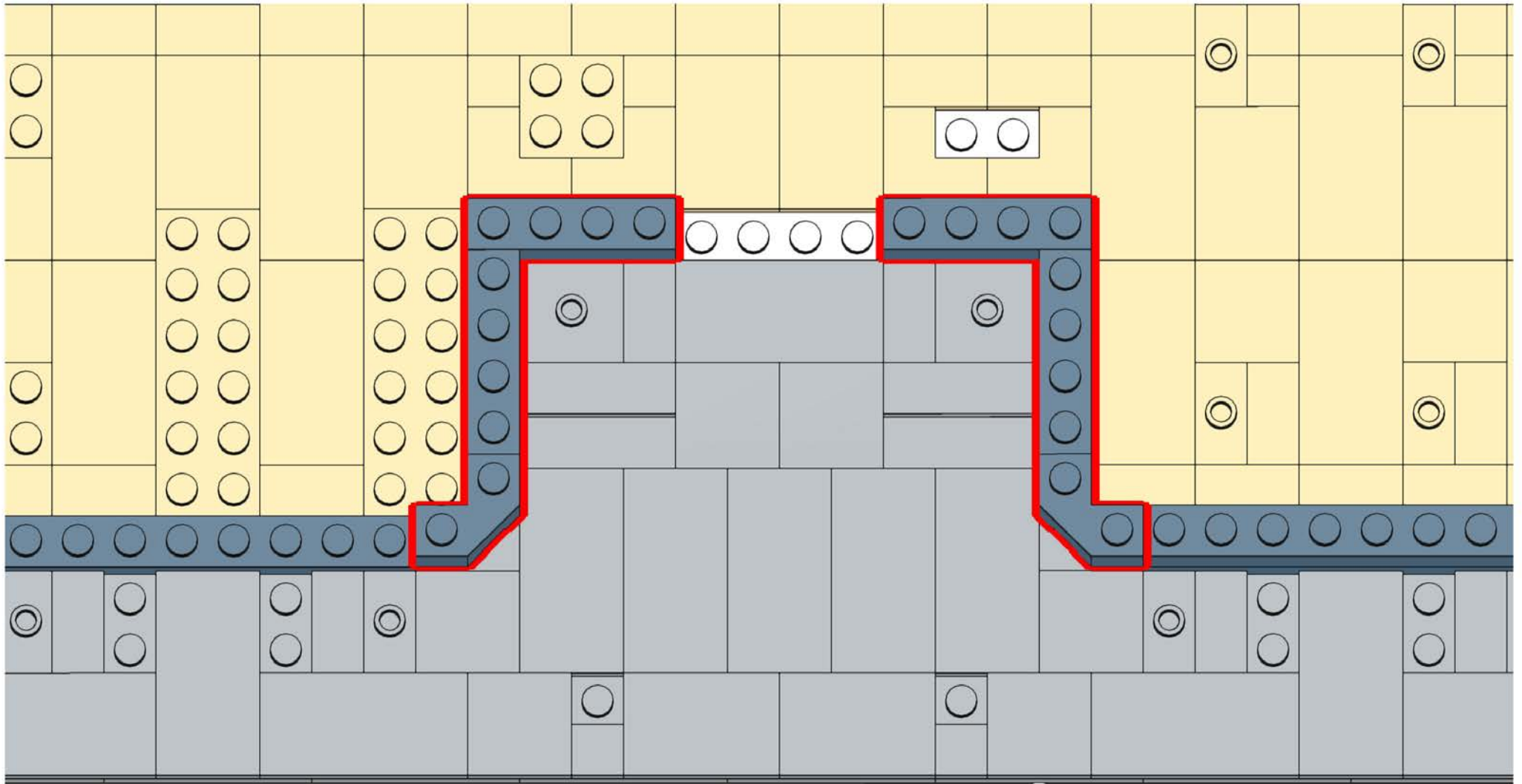

56



2x

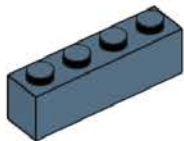

4x

# 57



1x

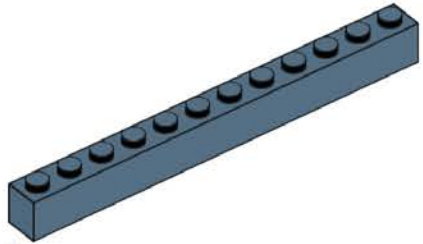

3x

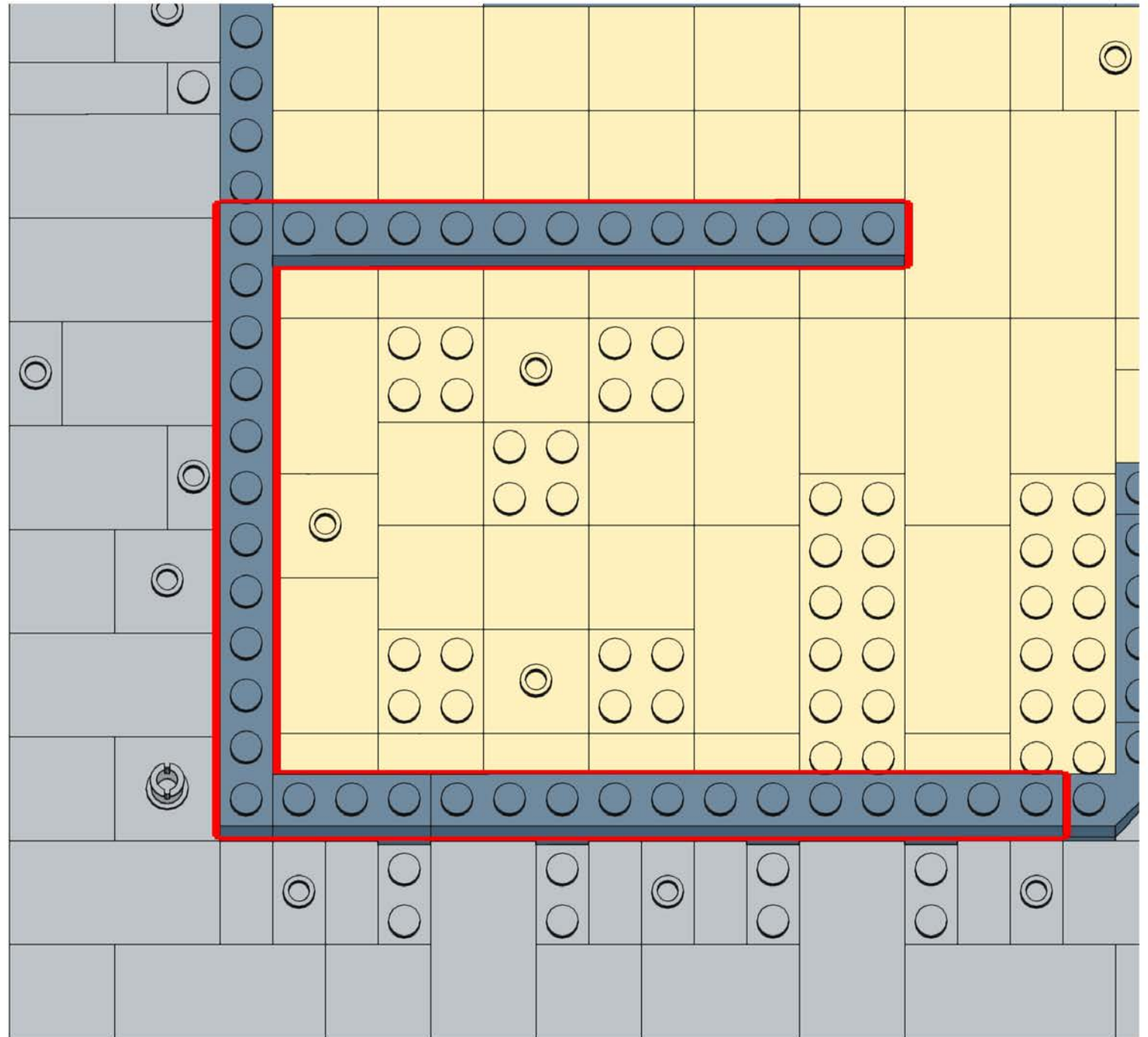

# 58

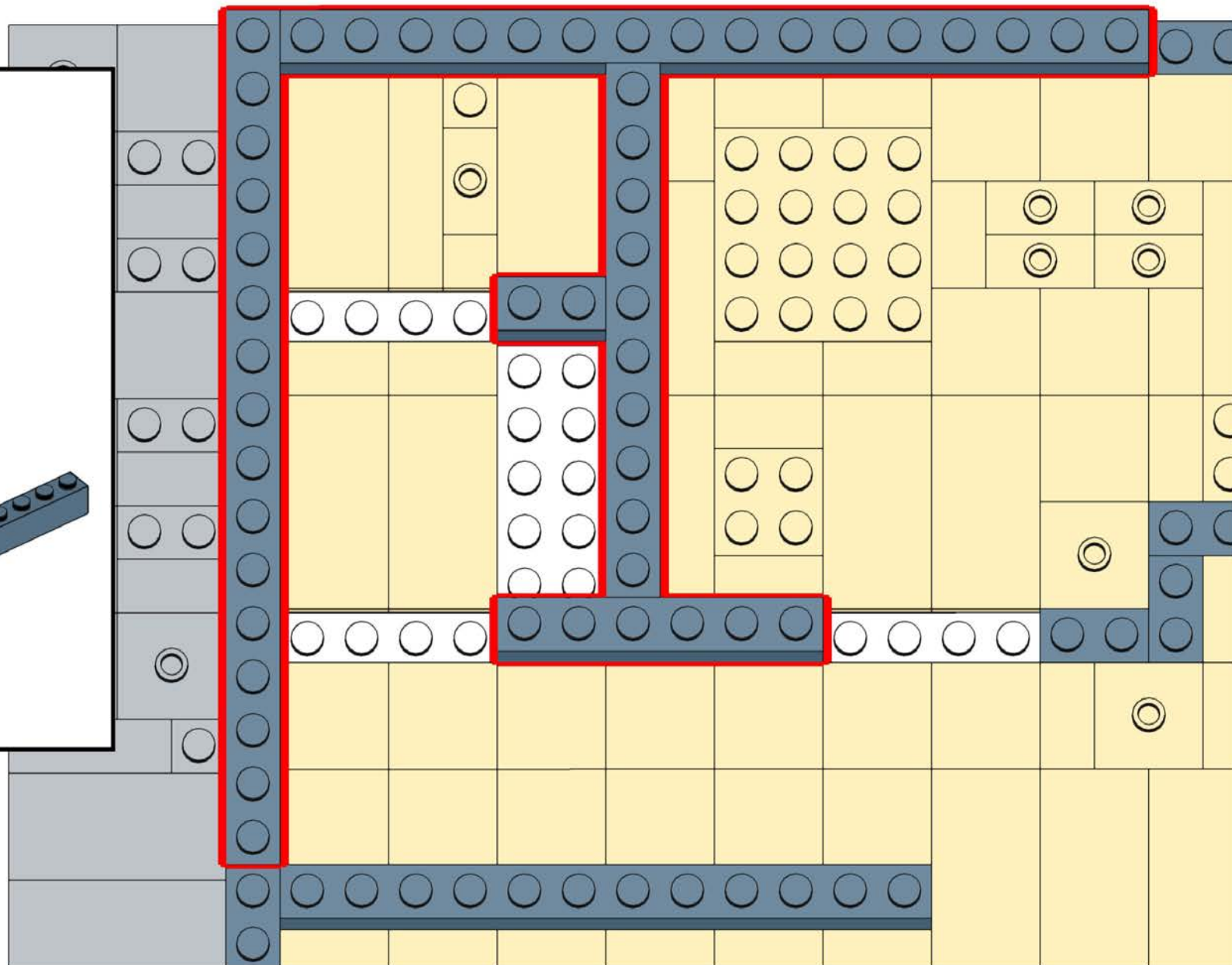
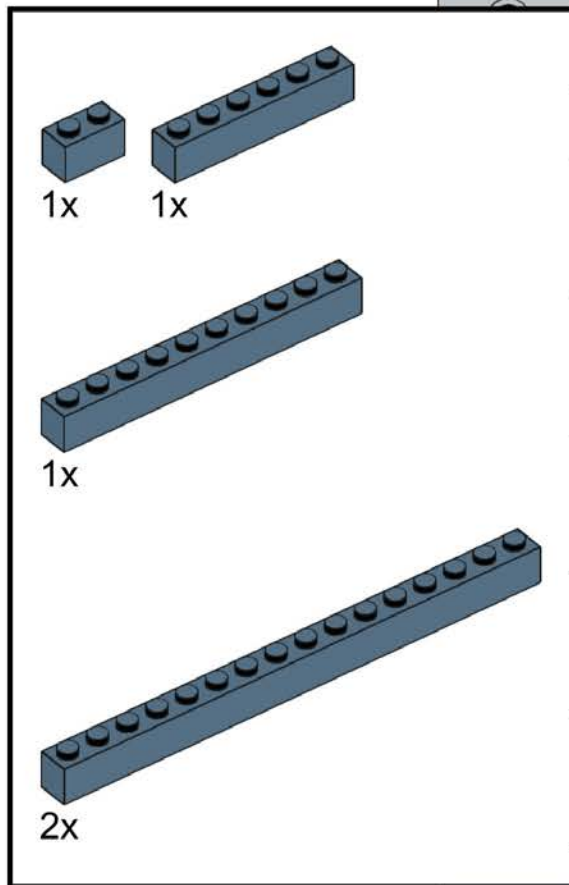

# 59

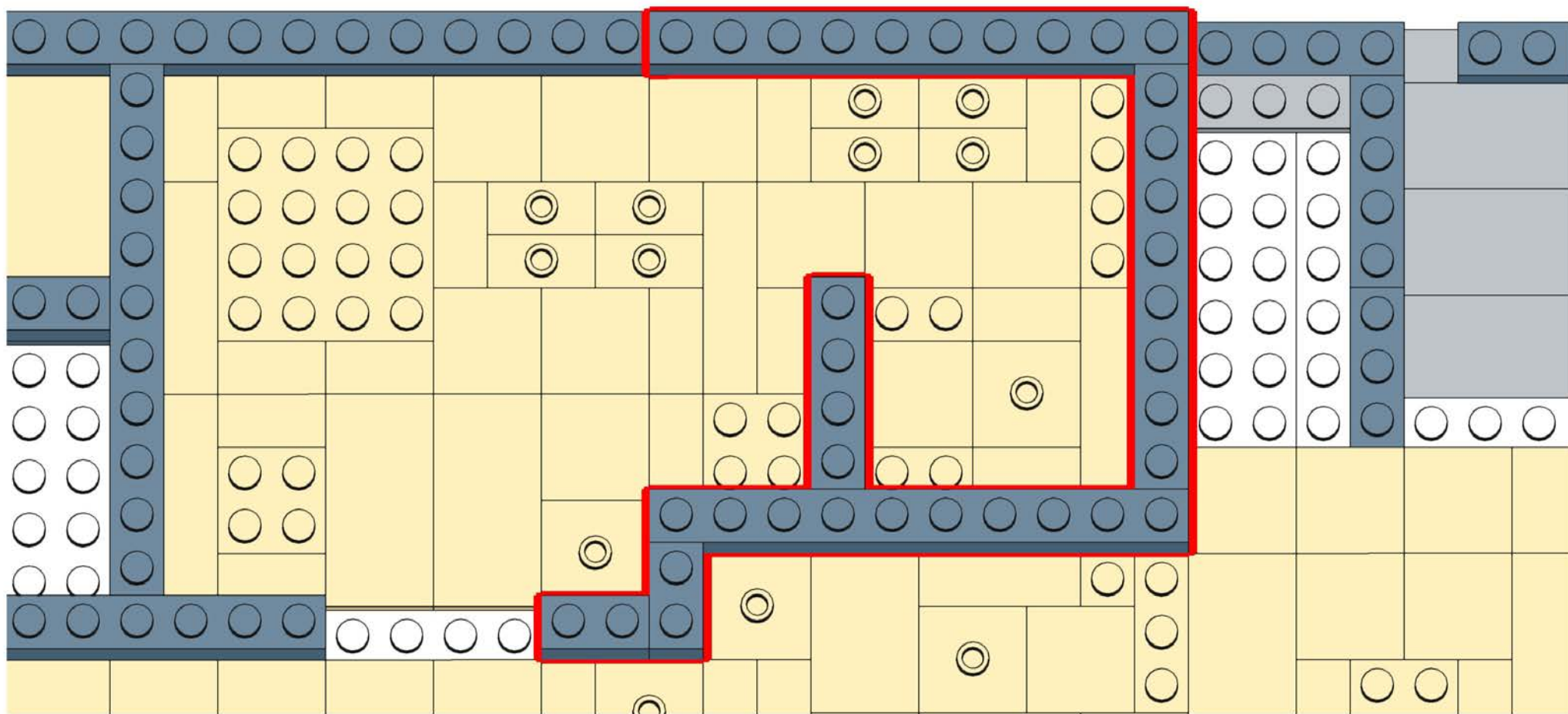
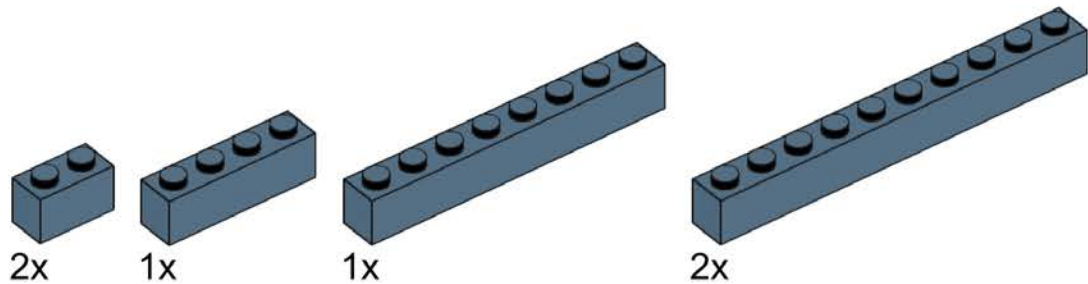

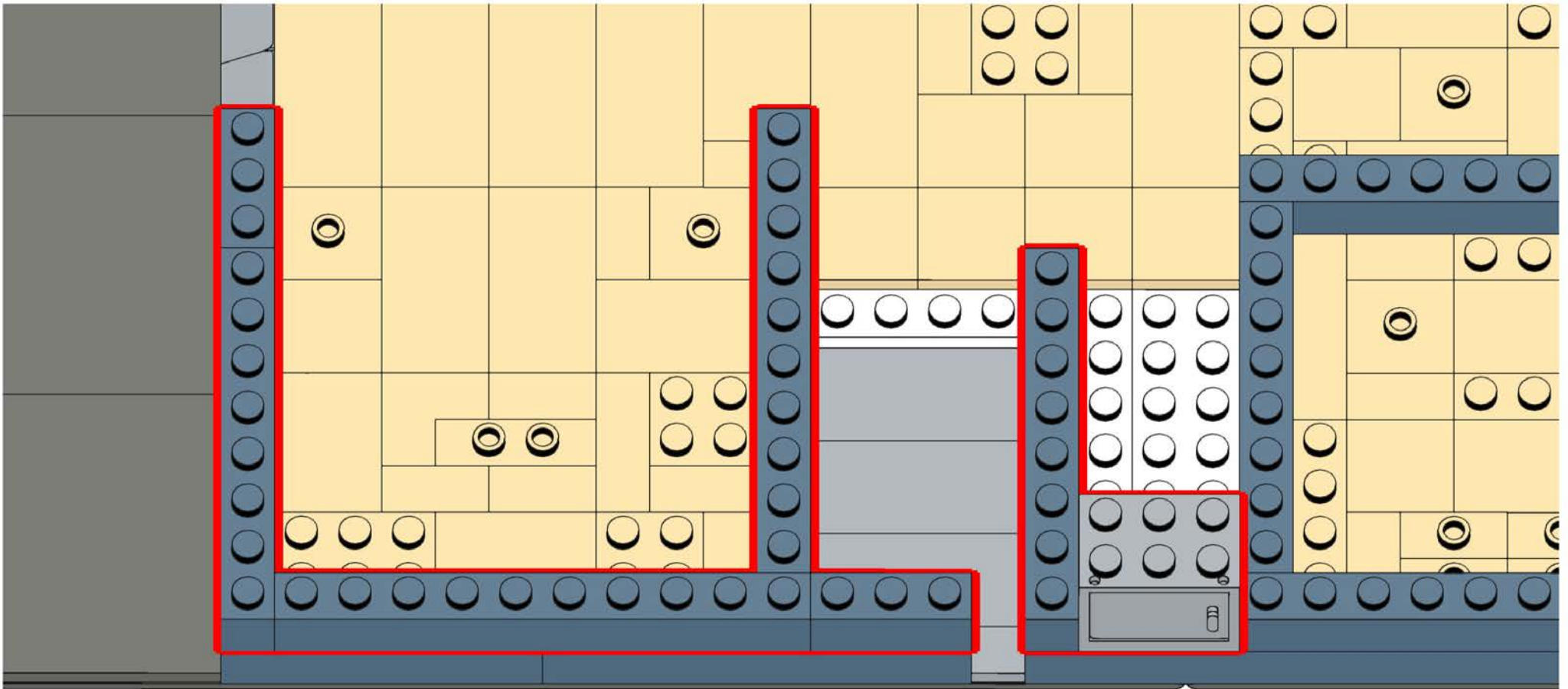

60

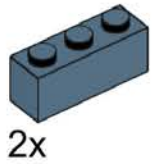

2x

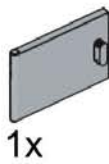

1x



1x

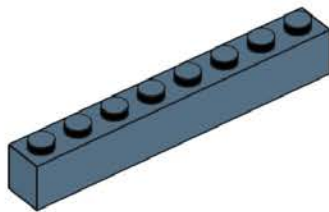

2x

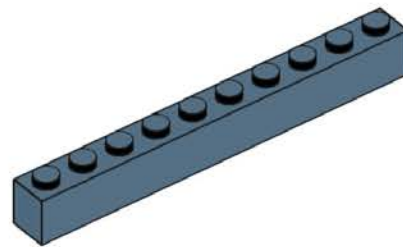

2x



# 61

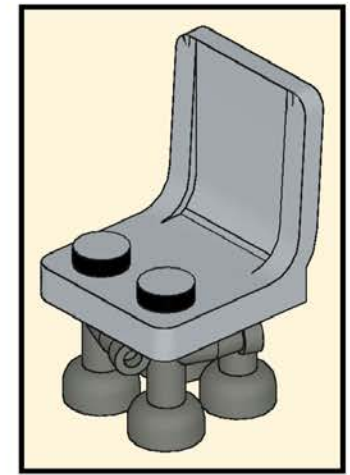
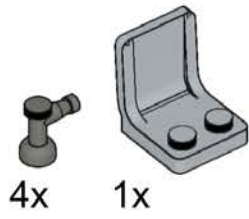

**5x**

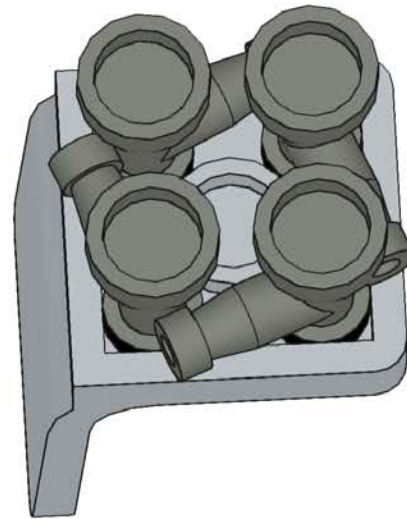

62

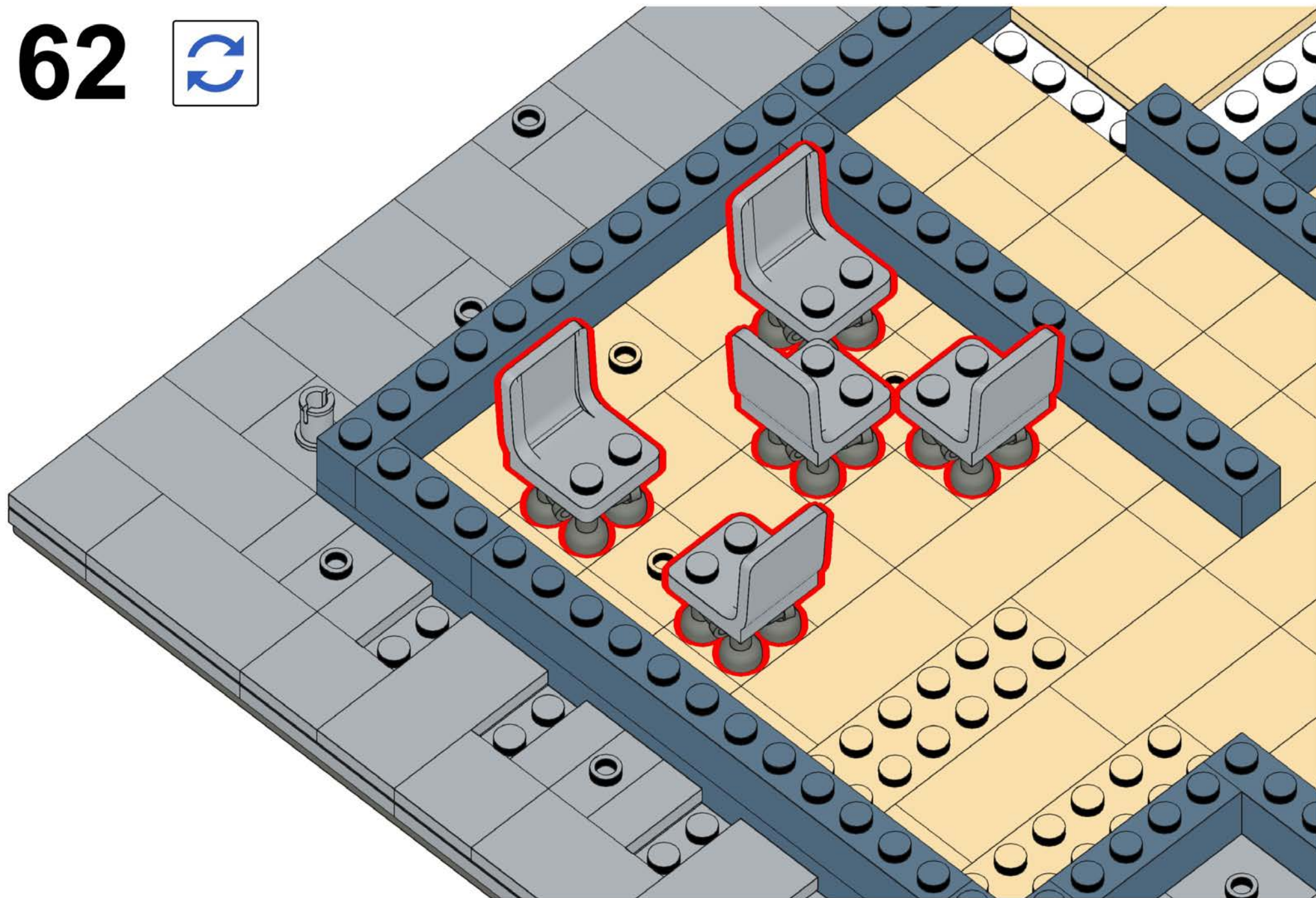

# 63

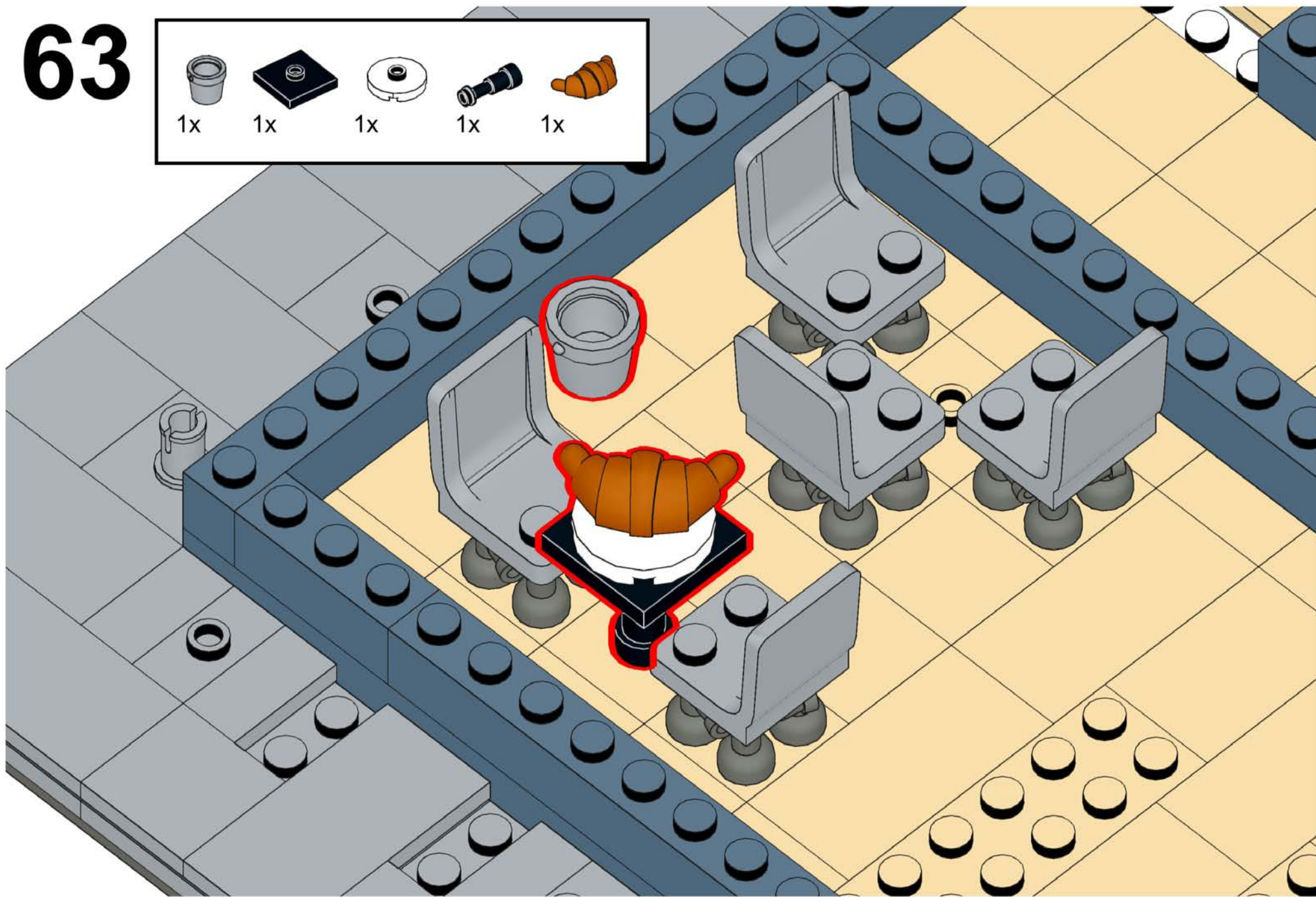
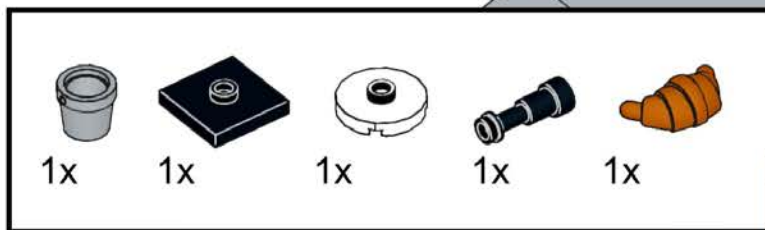



# 64

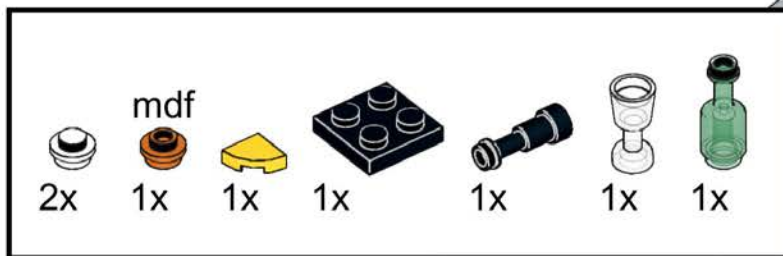

Medium Dark Flesh = mdf

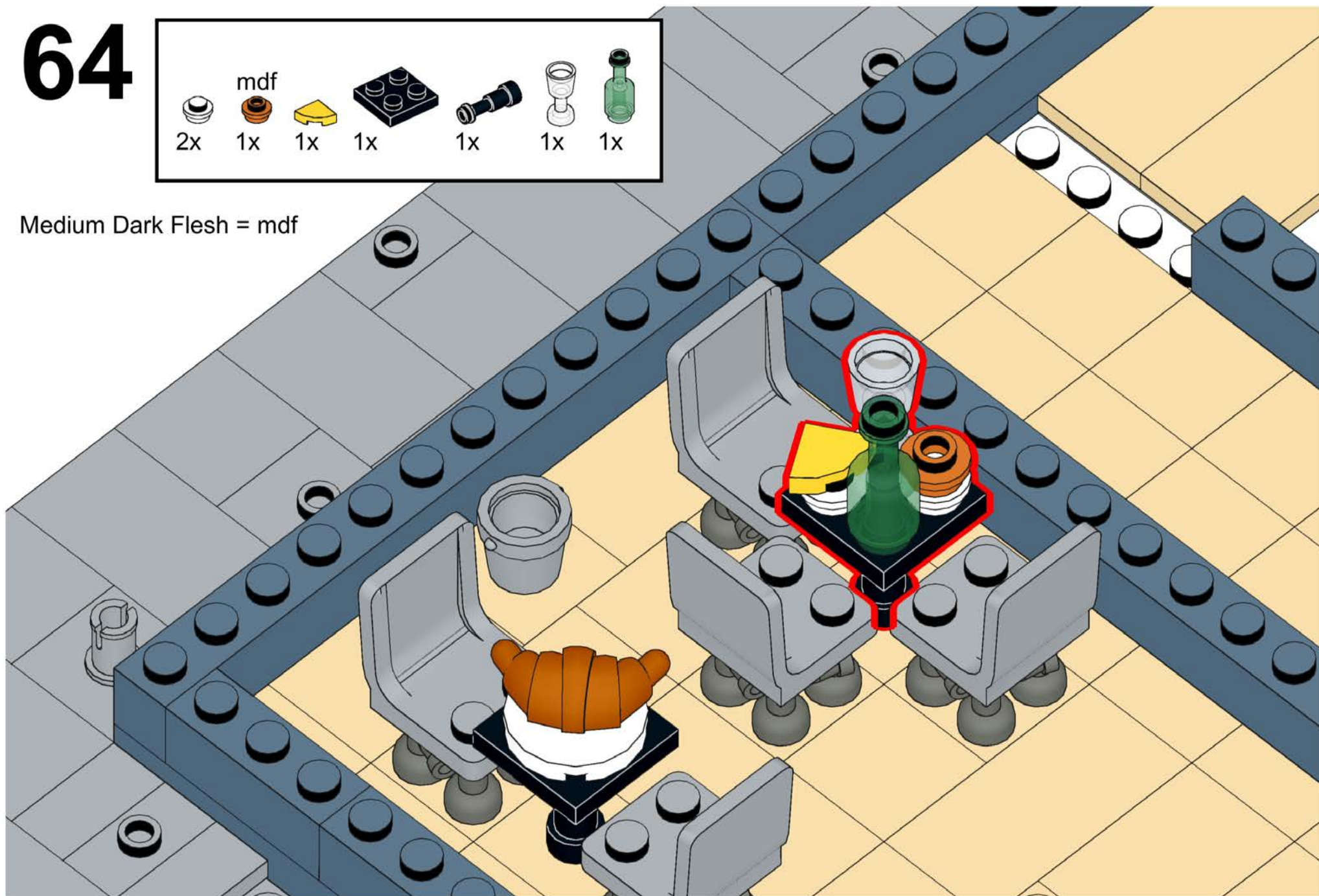

# 65

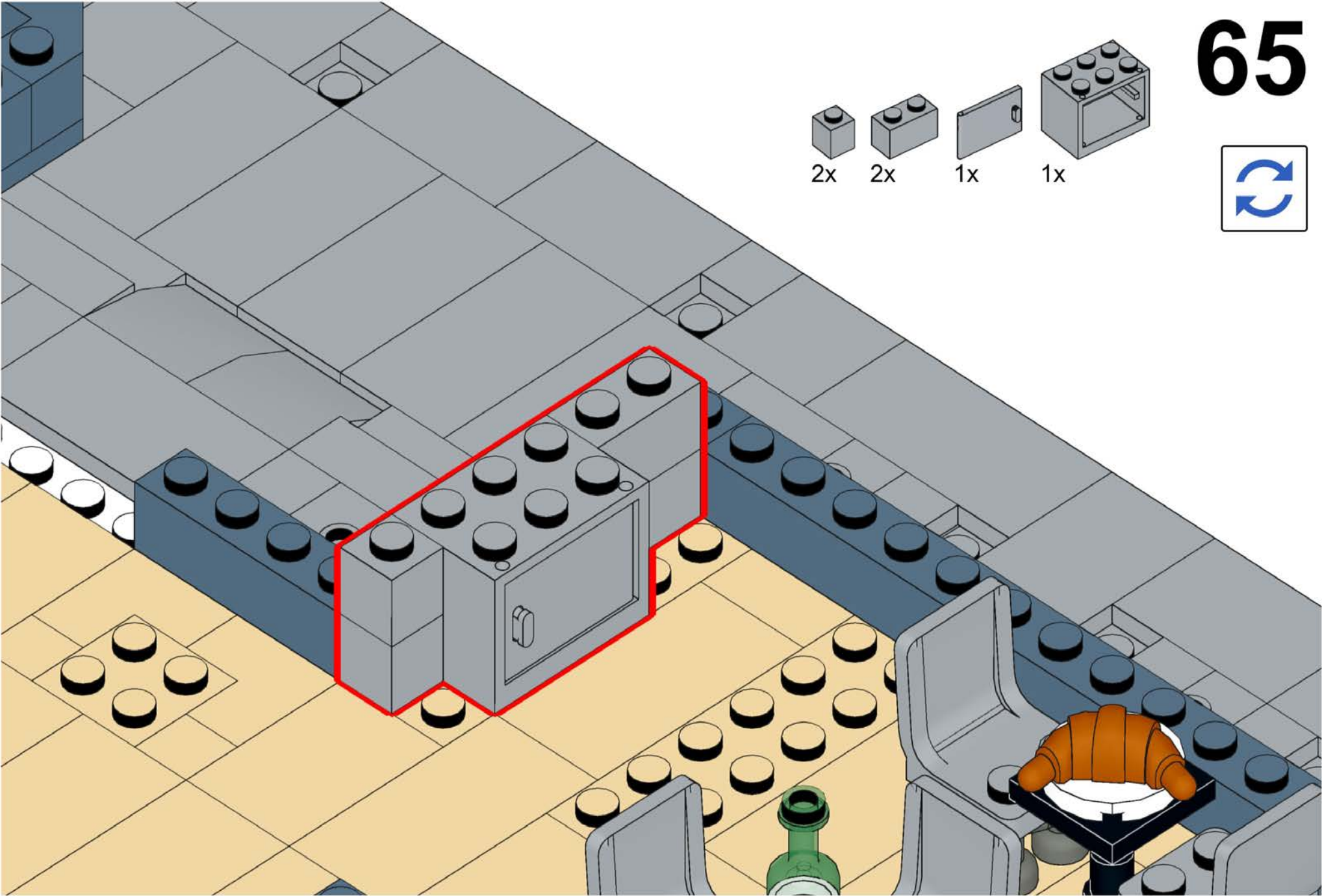
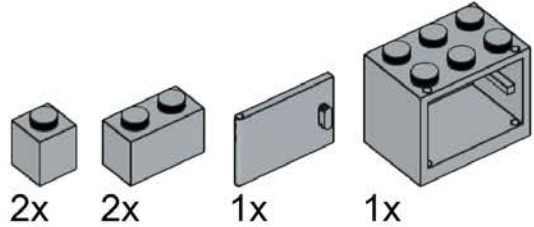

66



6x



1x

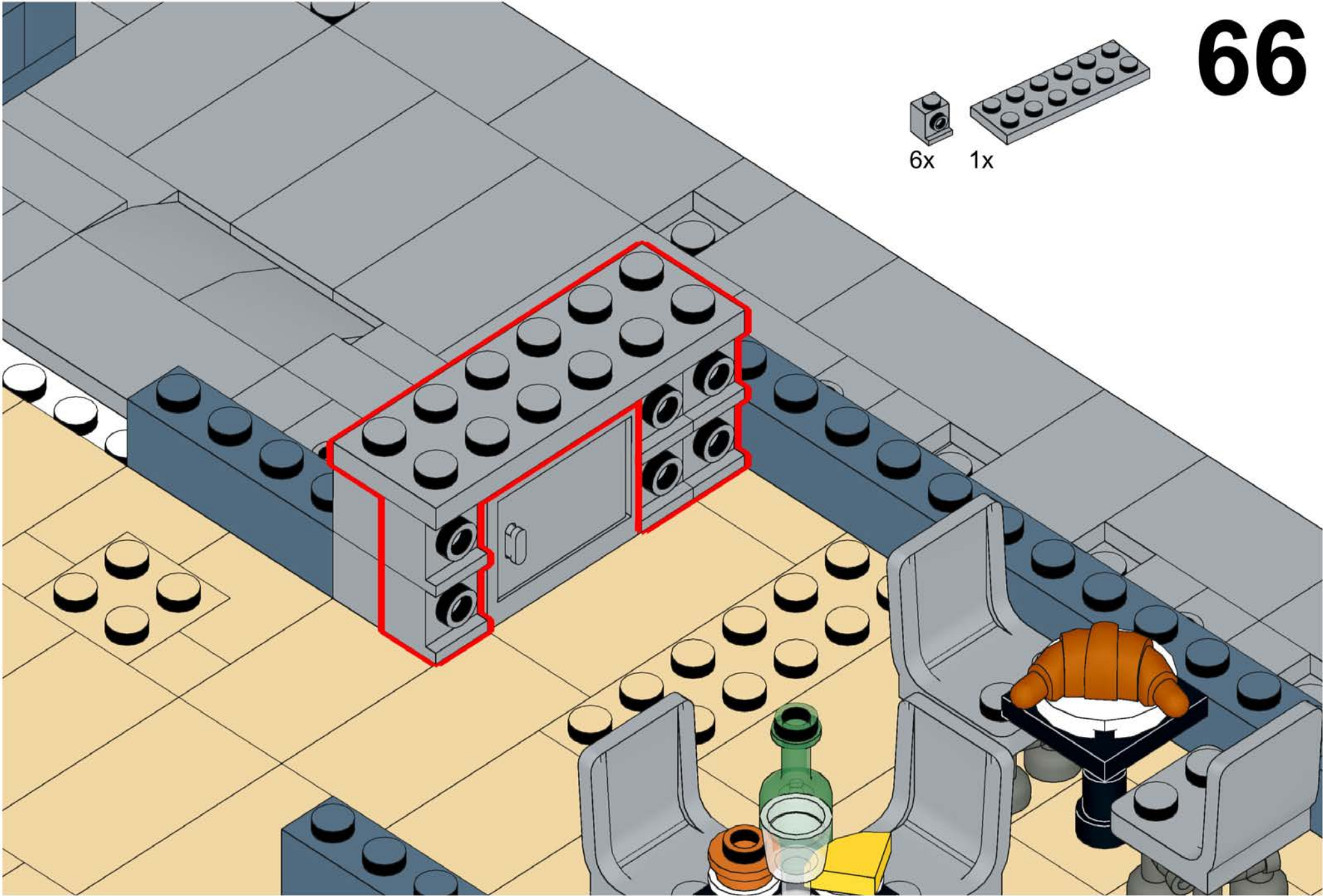

# 67

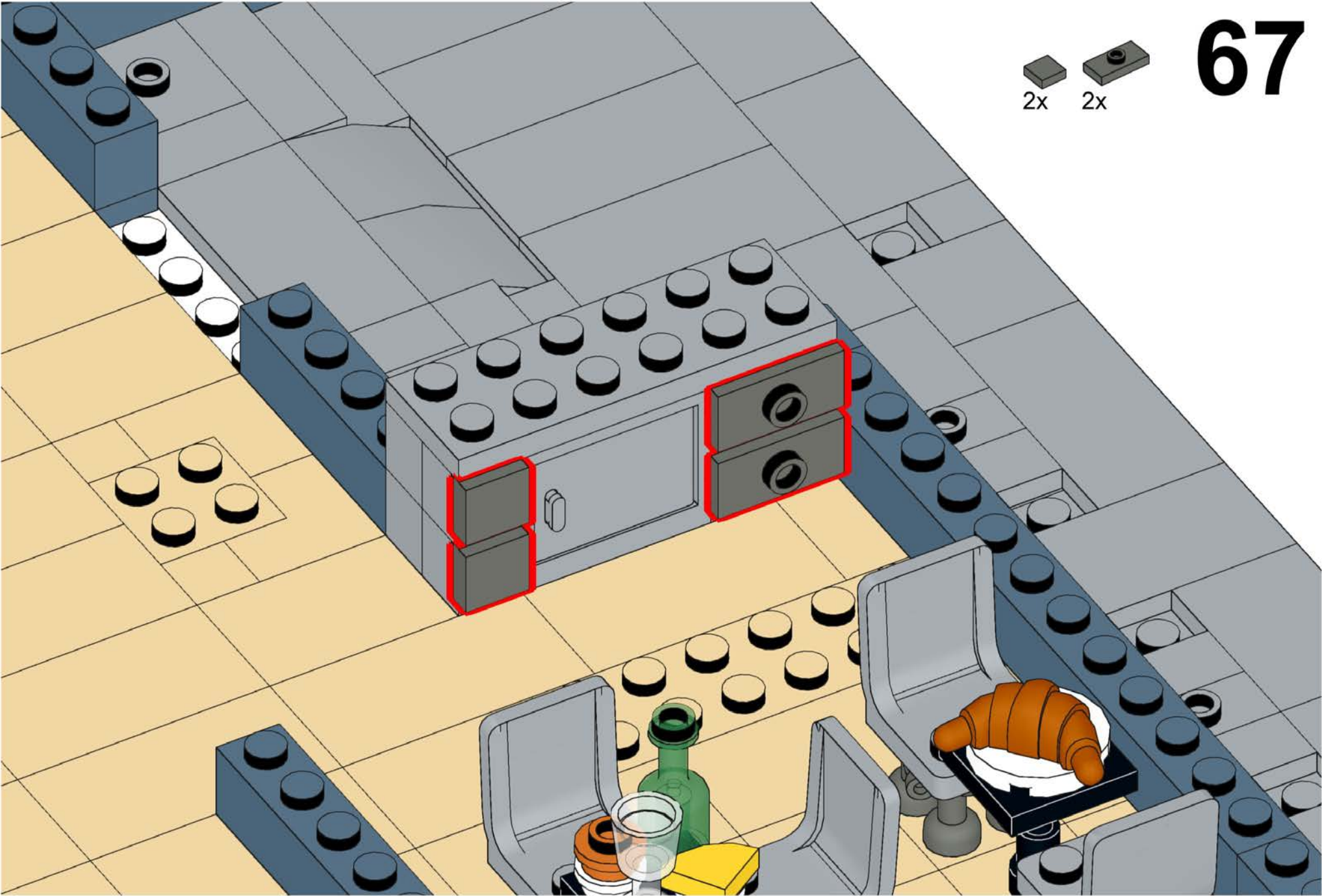
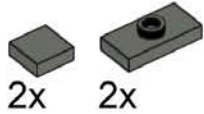

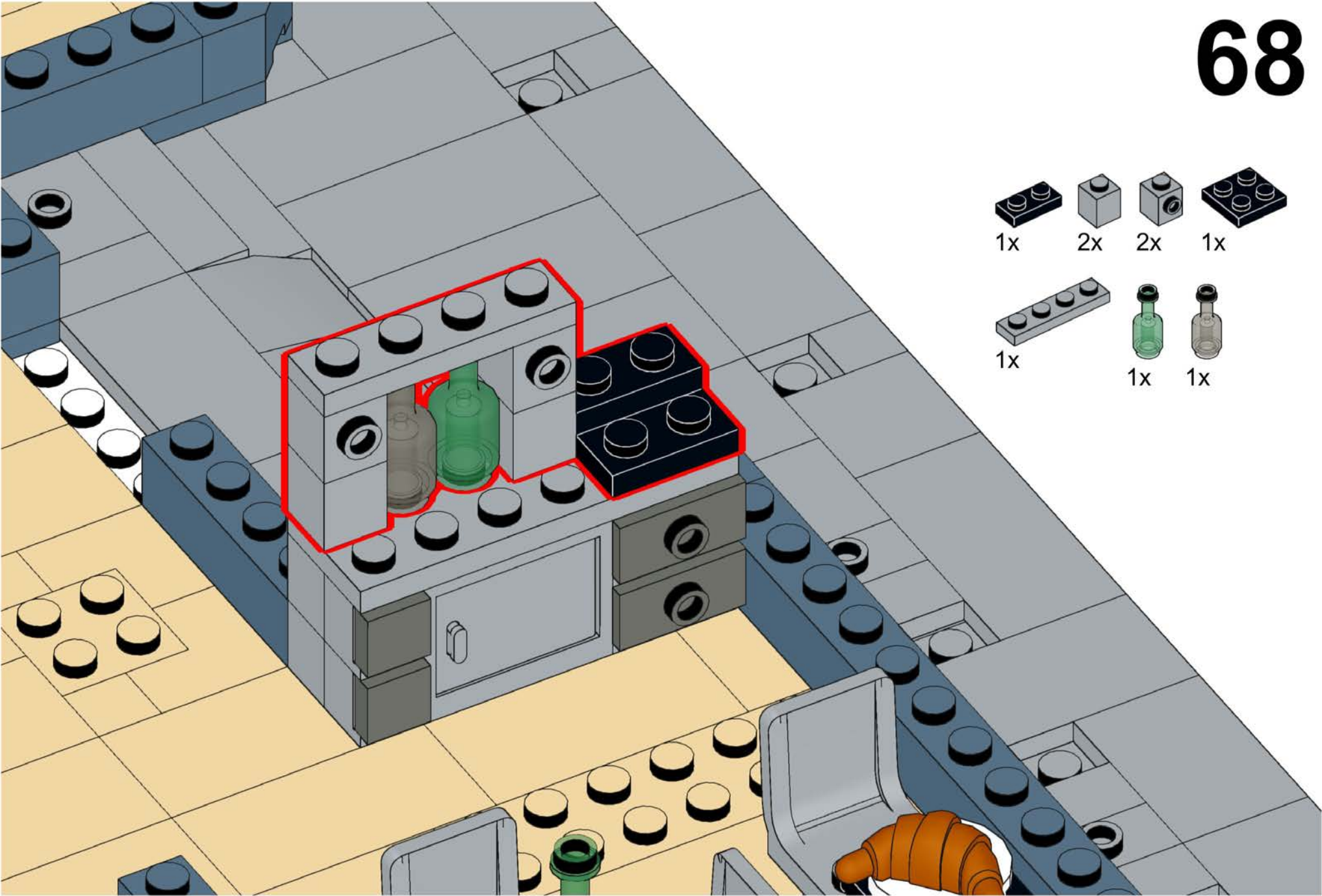

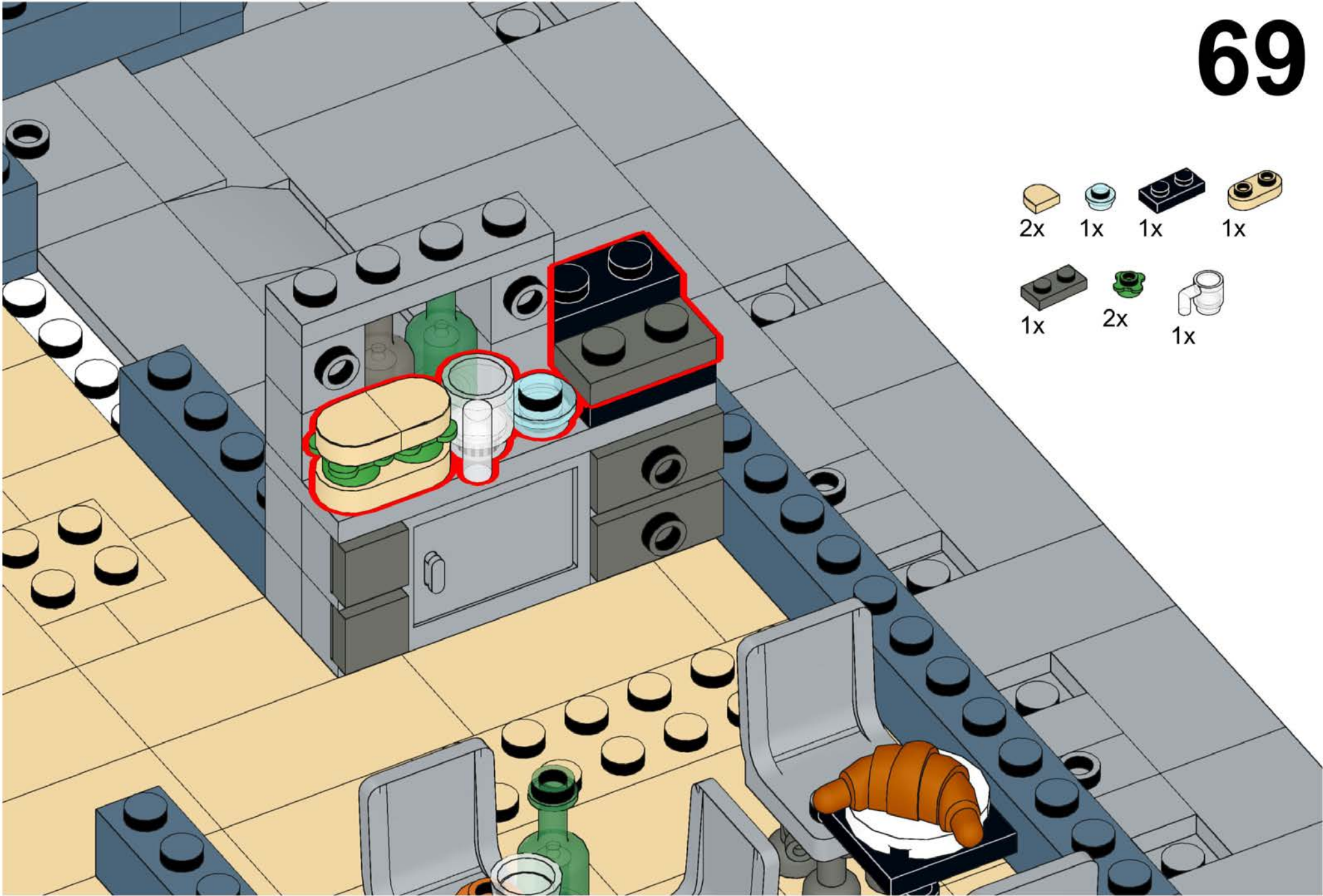



1x	2x	1x	2x	1x	1x



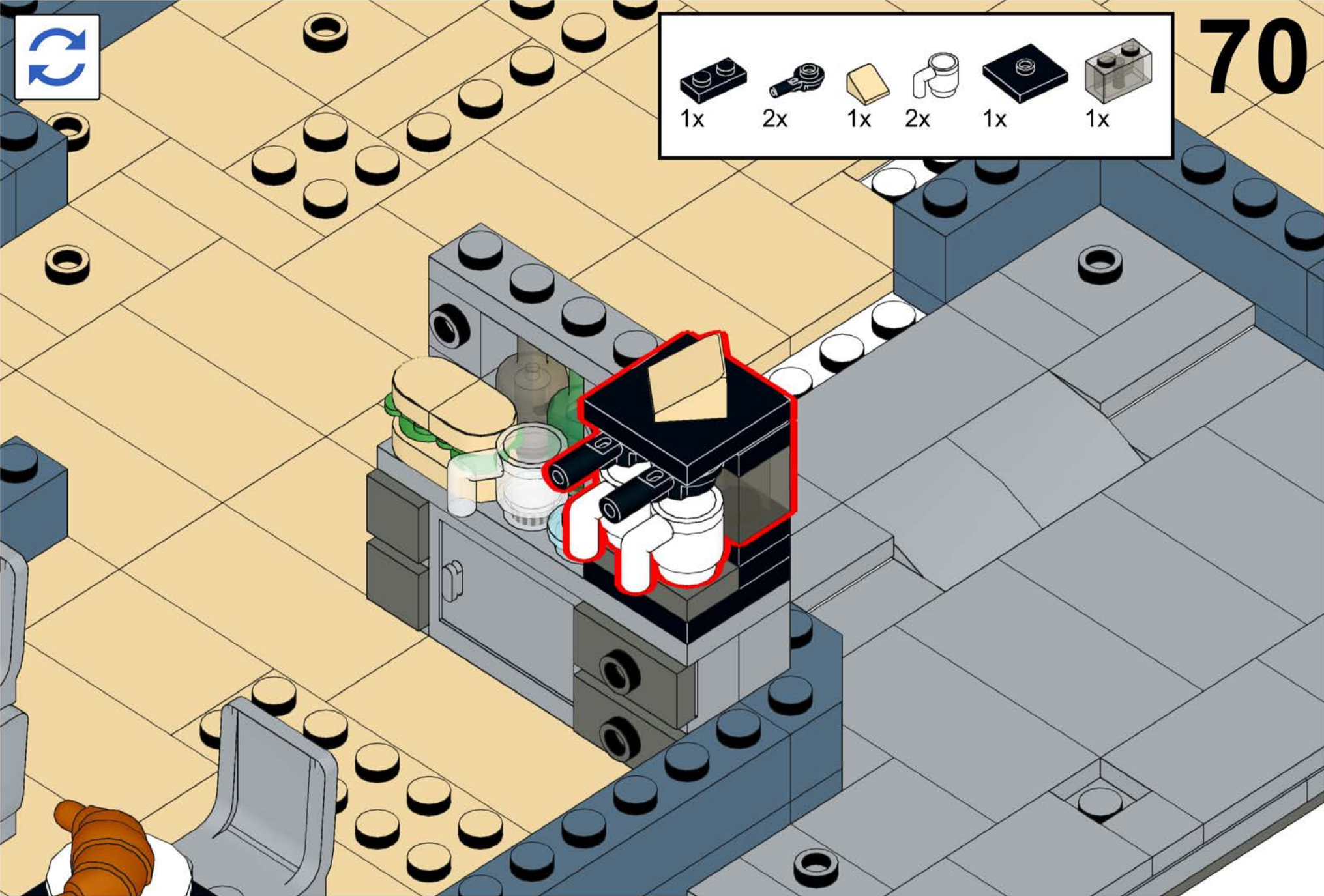



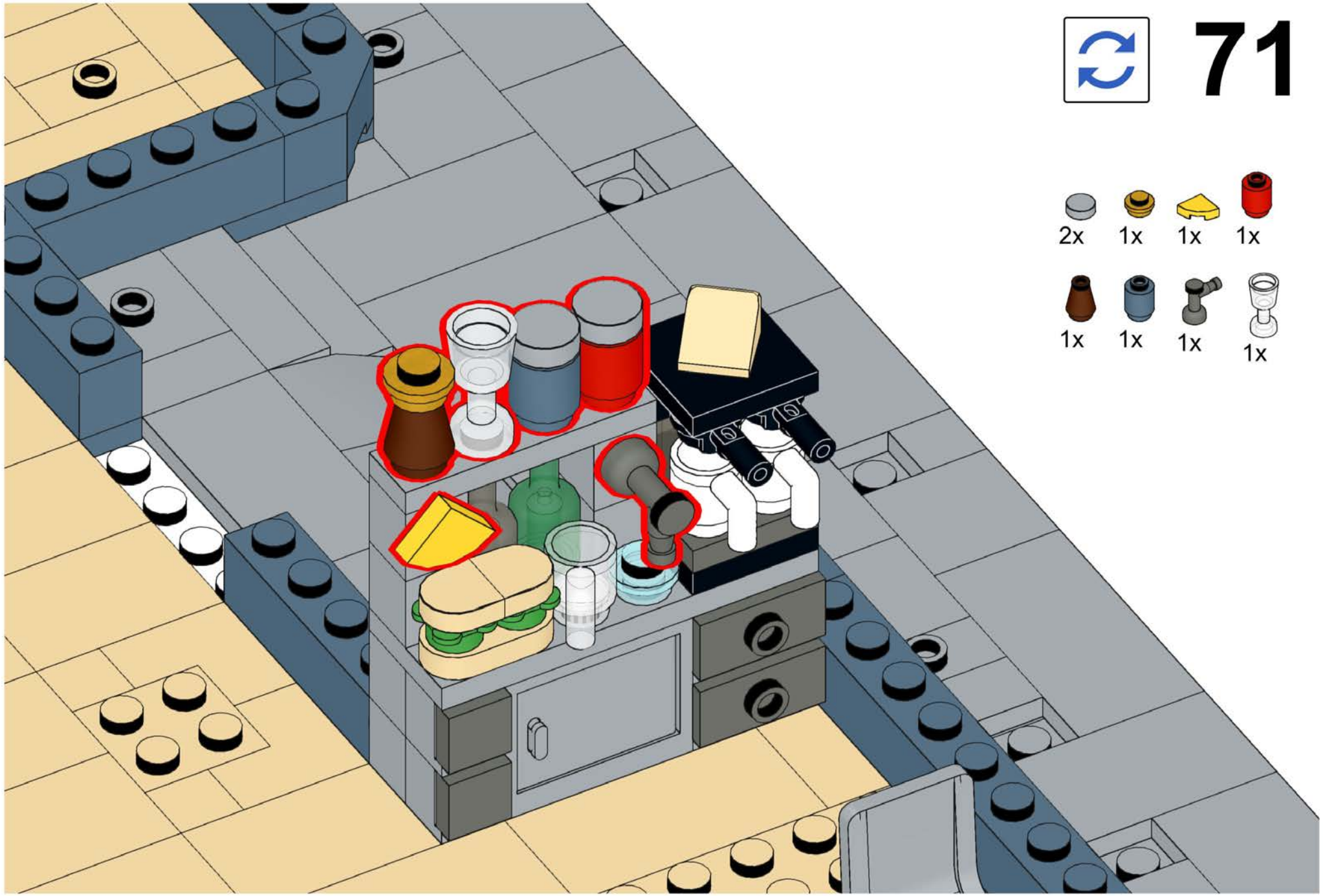

70





# 71



- |                                                                                           |                                                                                           |                                                                                           |                                                                                           |
|-------------------------------------------------------------------------------------------|-------------------------------------------------------------------------------------------|-------------------------------------------------------------------------------------------|-------------------------------------------------------------------------------------------|
| <br>2x | <br>1x | <br>1x | <br>1x |
| <br>1x | <br>1x | <br>1x | <br>1x |



# 72

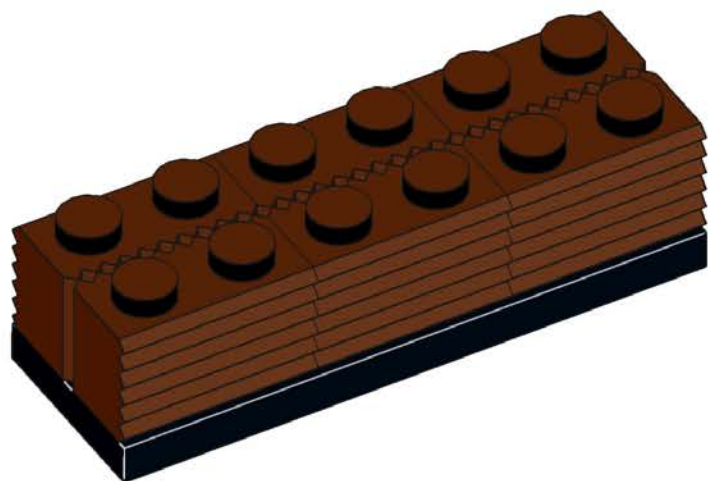
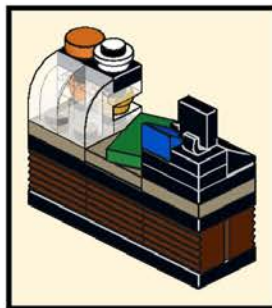
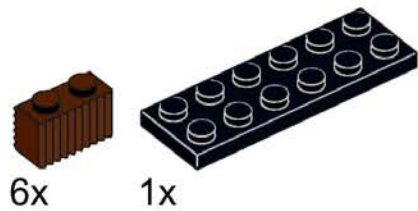

# 73

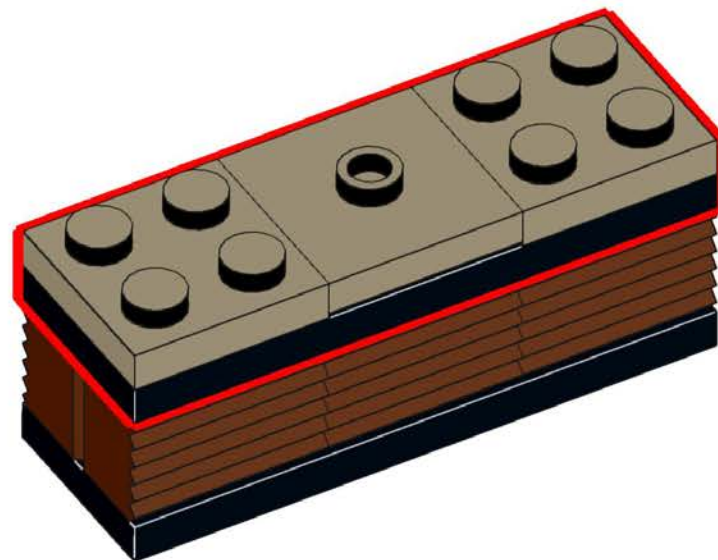
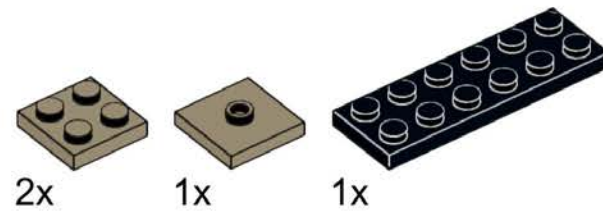

# 74

mdf



1x



1x



1x

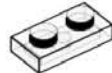

1x



1x



1x

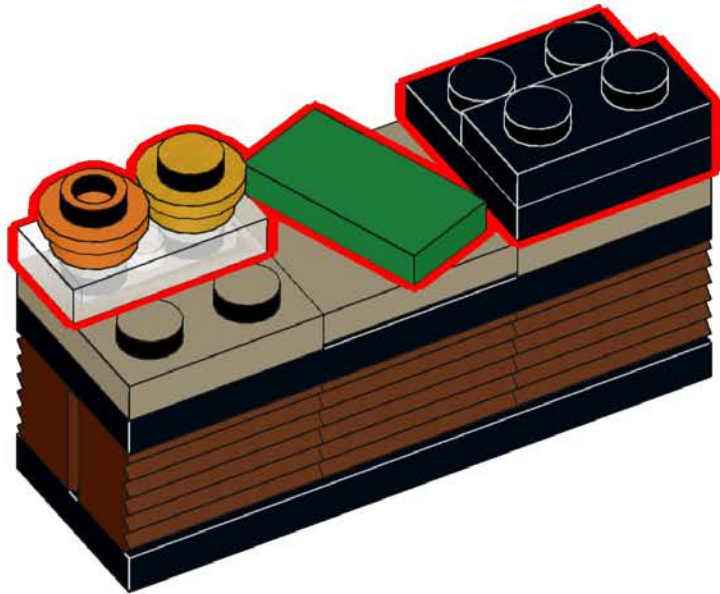

# 75

mdf



1x



1x



1x



1x



1x

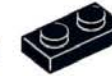

1x



1x



2x

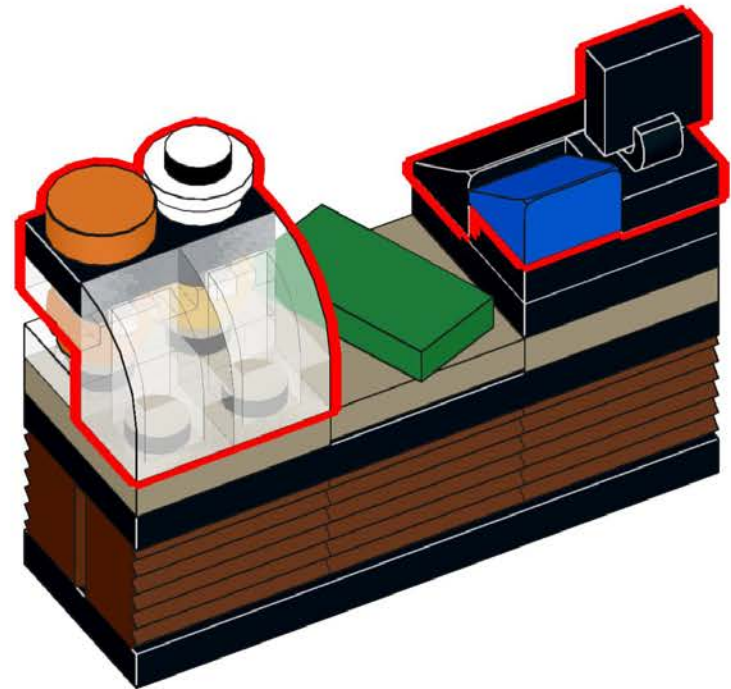

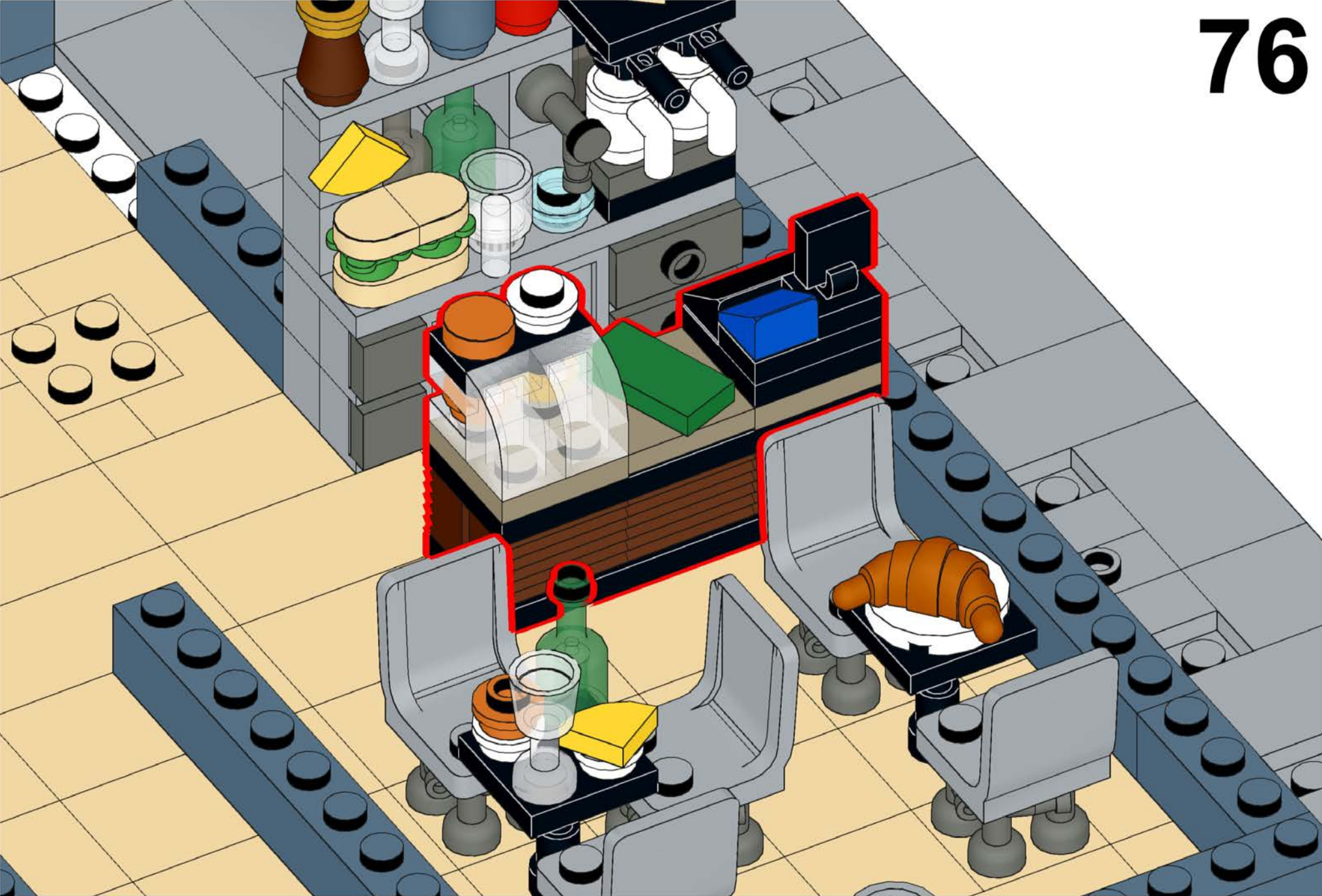

77

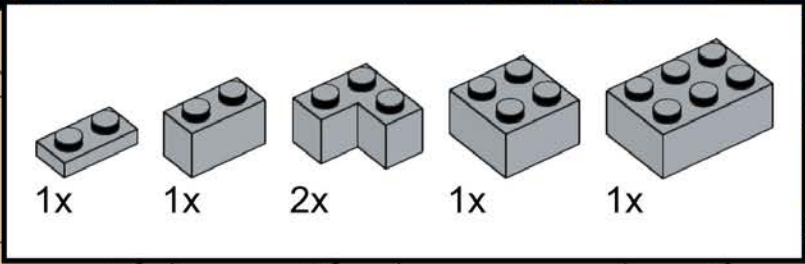



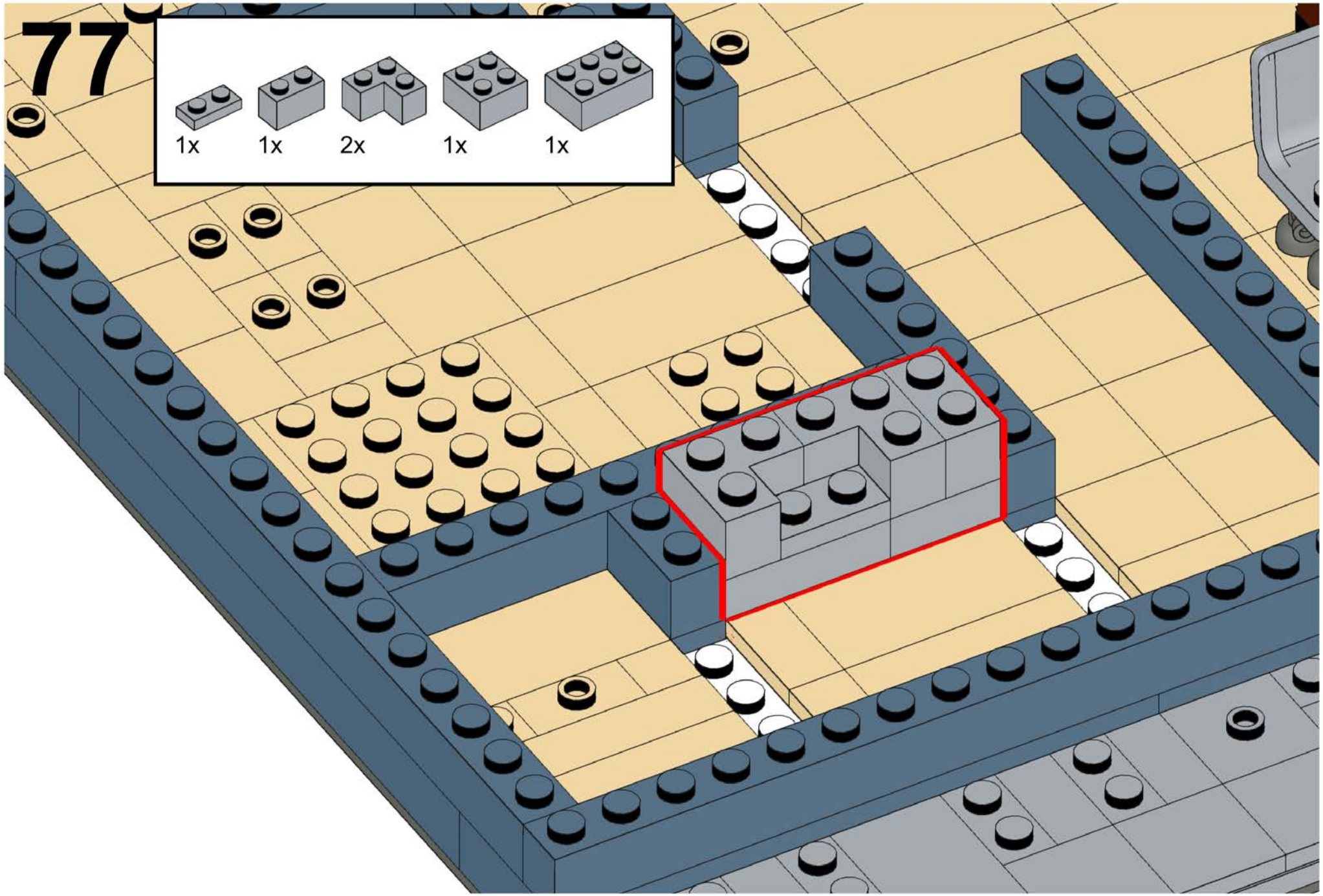

1x 1x 2x 1x 1x

This inset box lists the parts required for step 77. It contains five items: a 1x2 grey Technic brick with two holes, a 1x3 grey Technic brick with three holes, two 1x3 grey Technic L-shaped bricks with two holes, one 1x4 grey Technic brick with four holes, and one 1x5 grey Technic brick with five holes.





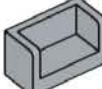

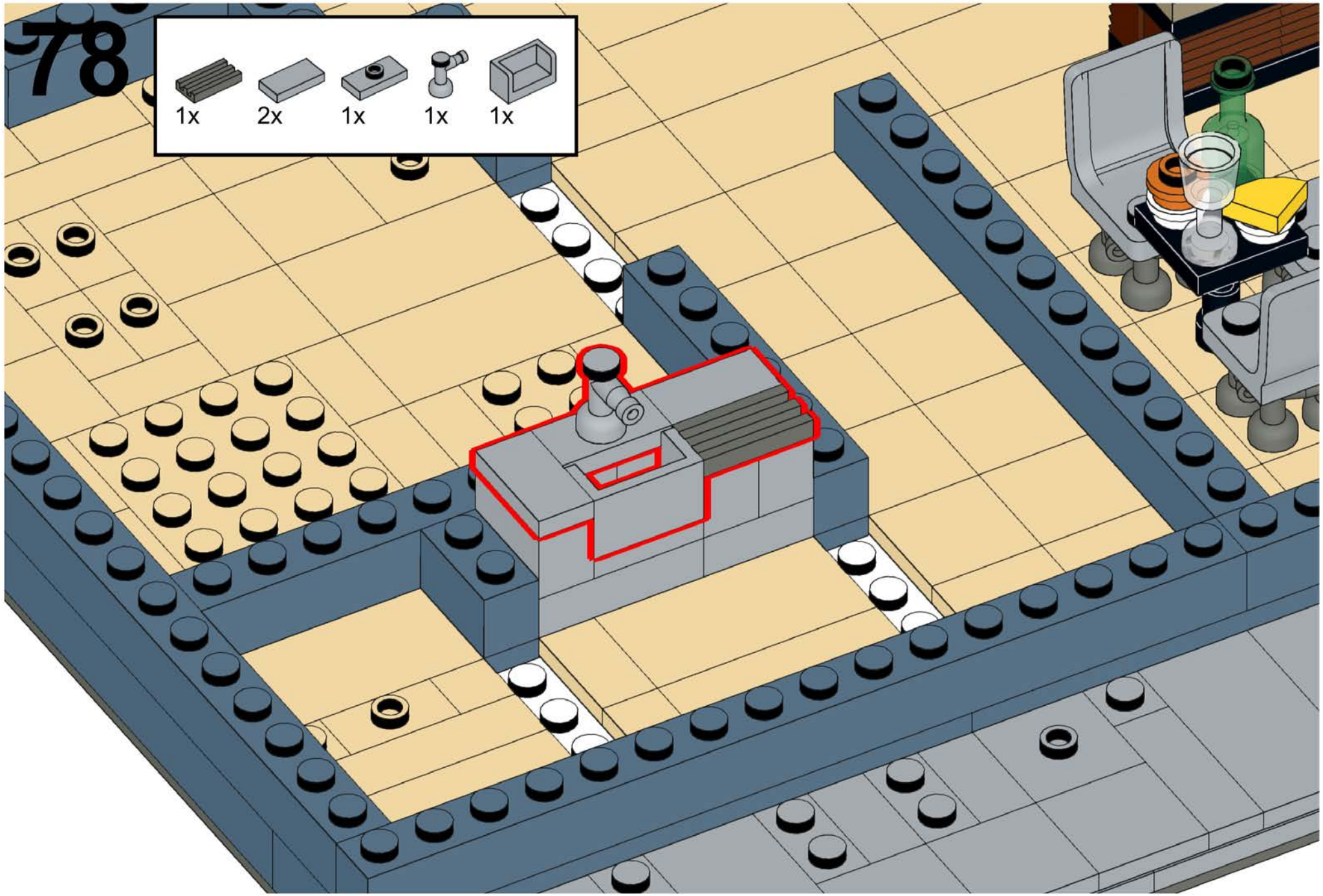
78

- 1x 
- 2x 
- 1x 
- 1x 
- 1x 



# 79

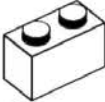

- 1x 
- 1x 
- 1x 
- 1x 
- 1x 

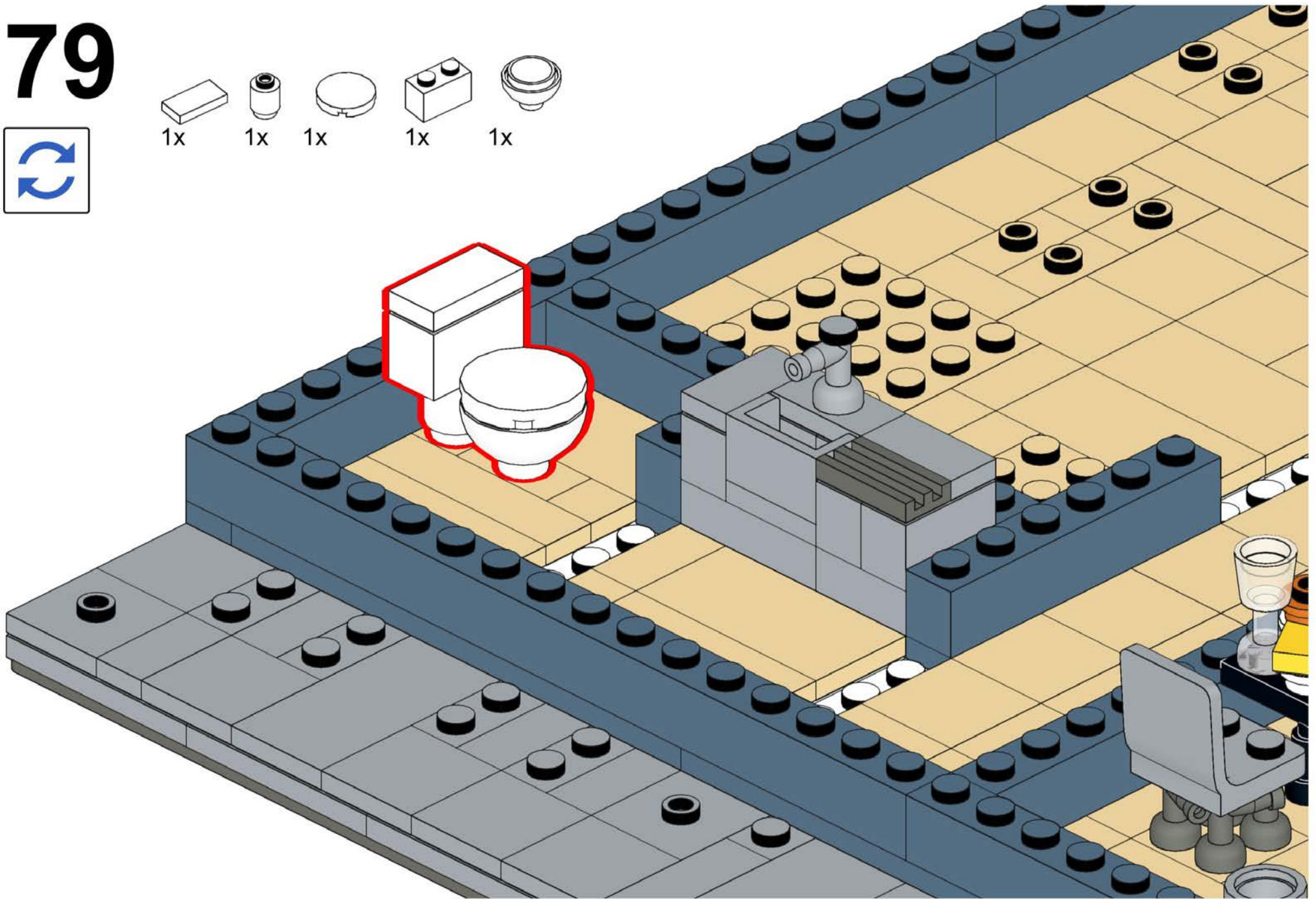

# 80

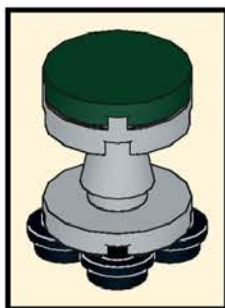
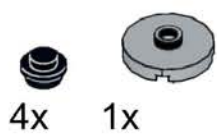

2x

# 81

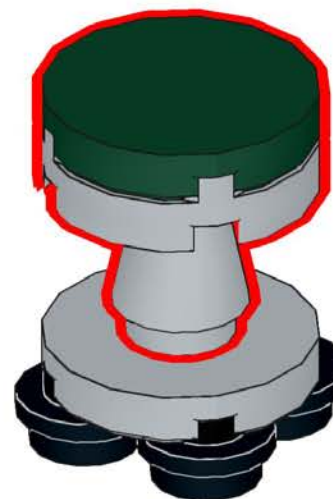



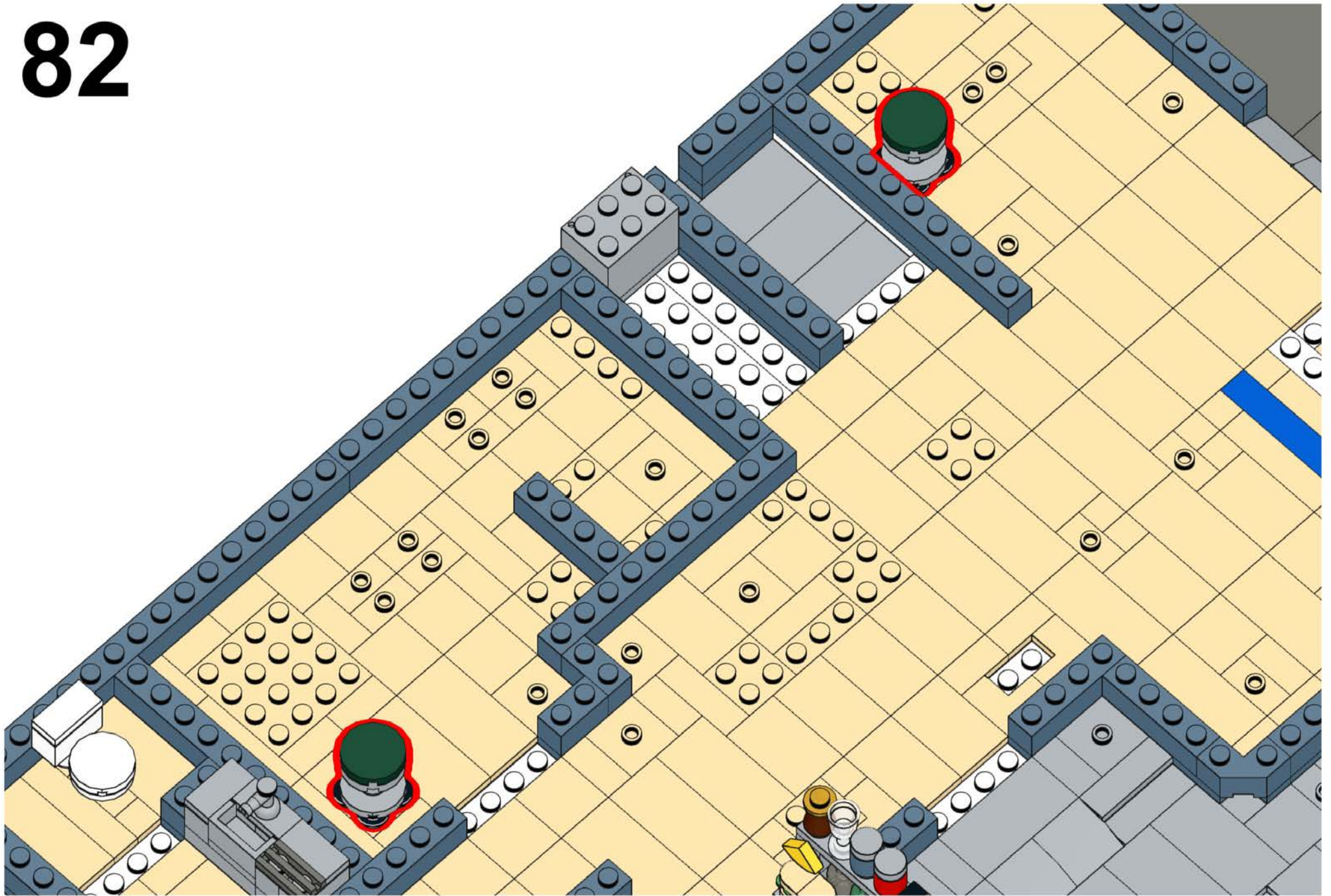

82





# 83

- 4x 
- 2x 
- 4x 
- 2x 

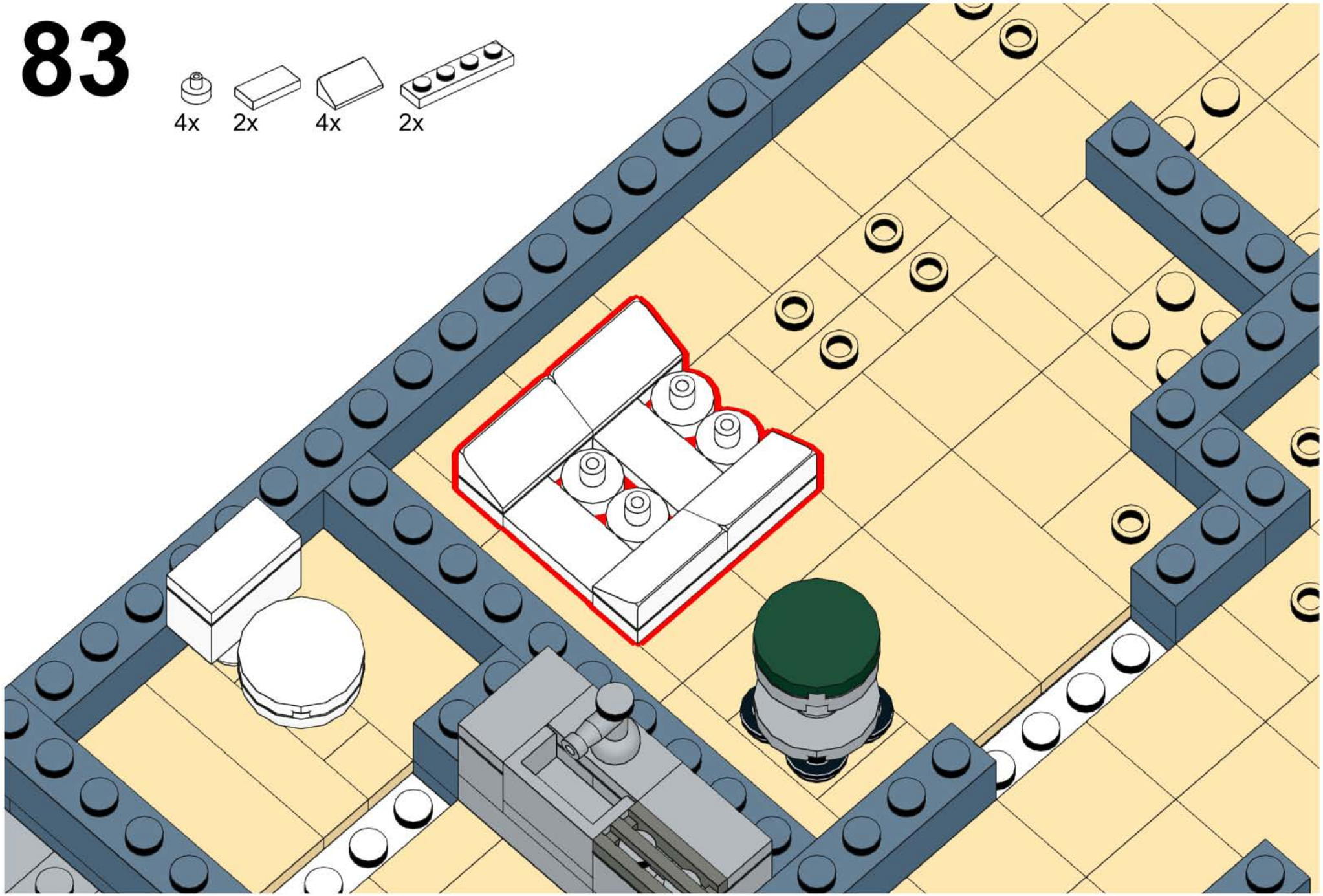

# 84

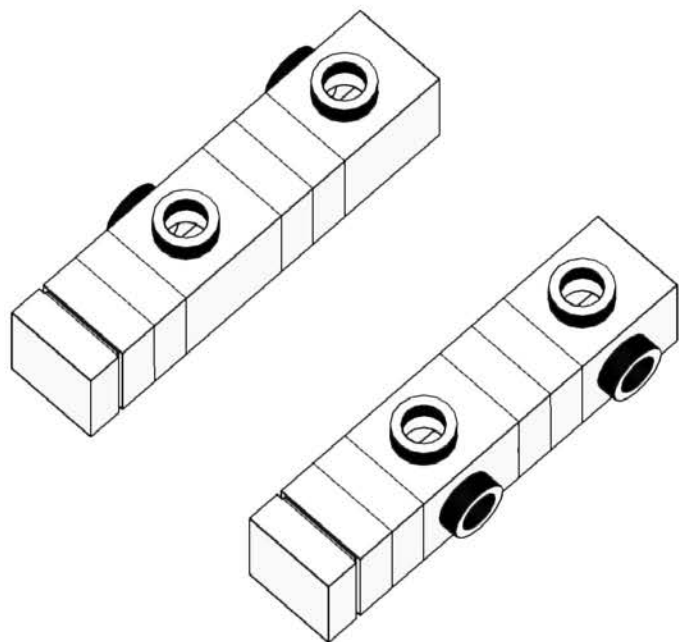
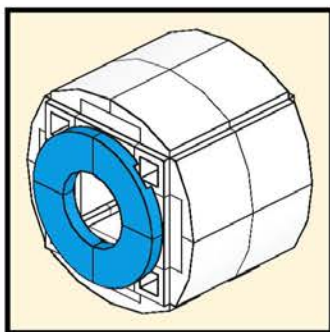
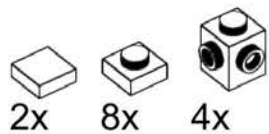

# 85

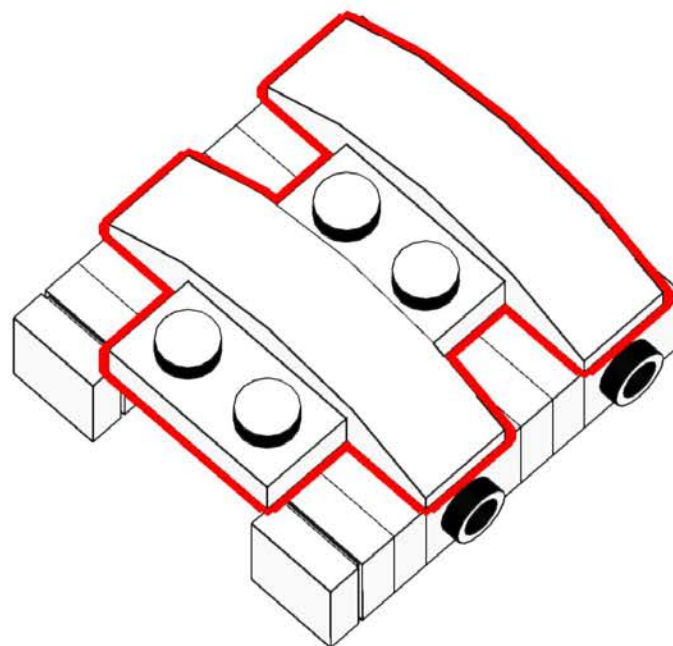
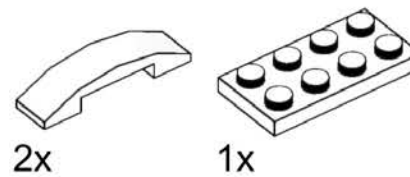

# 86

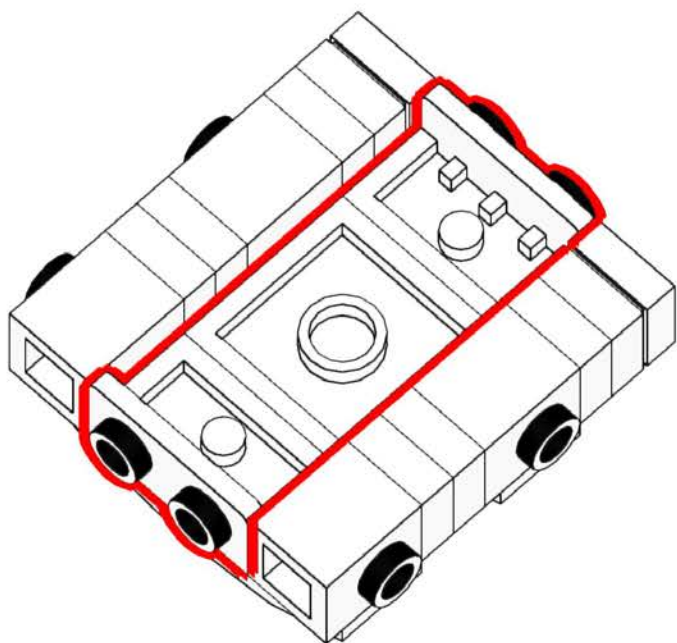
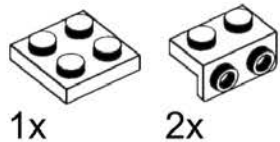

# 87

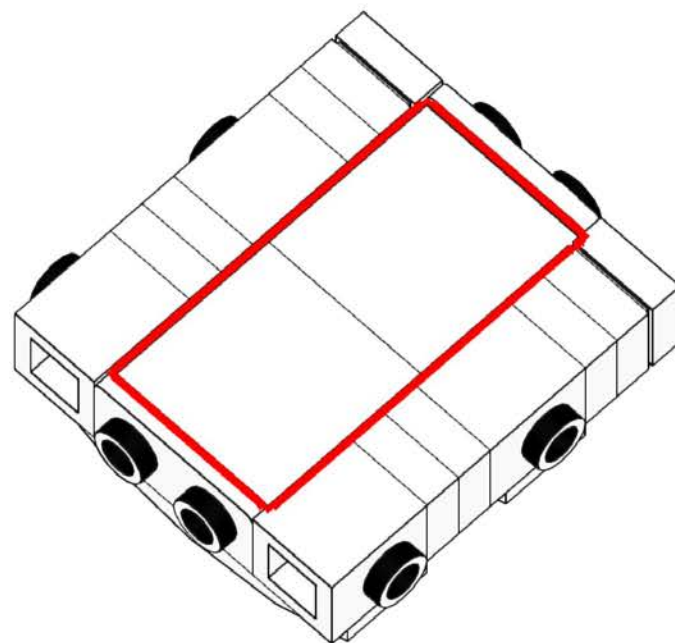
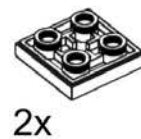

# 88

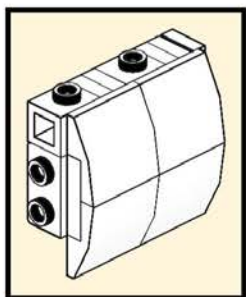
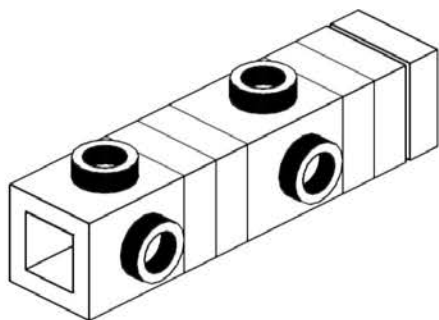
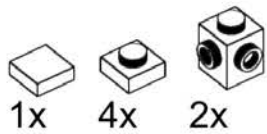

# 89

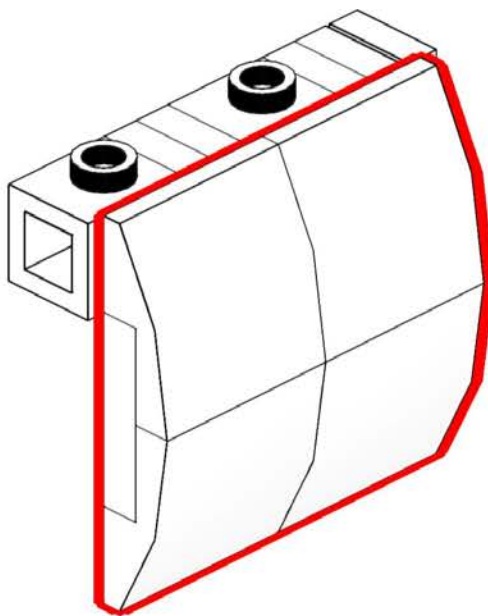
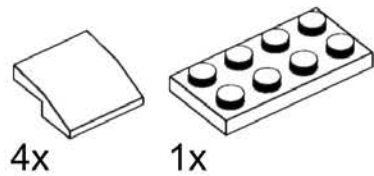

# 90

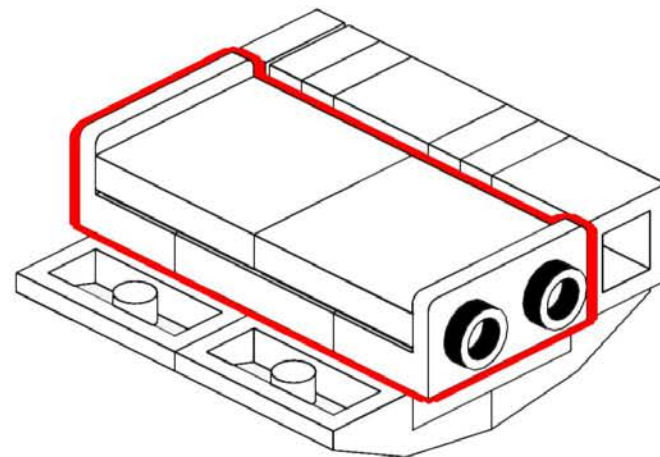
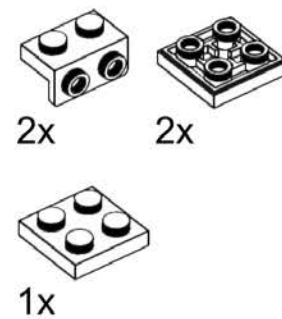

91

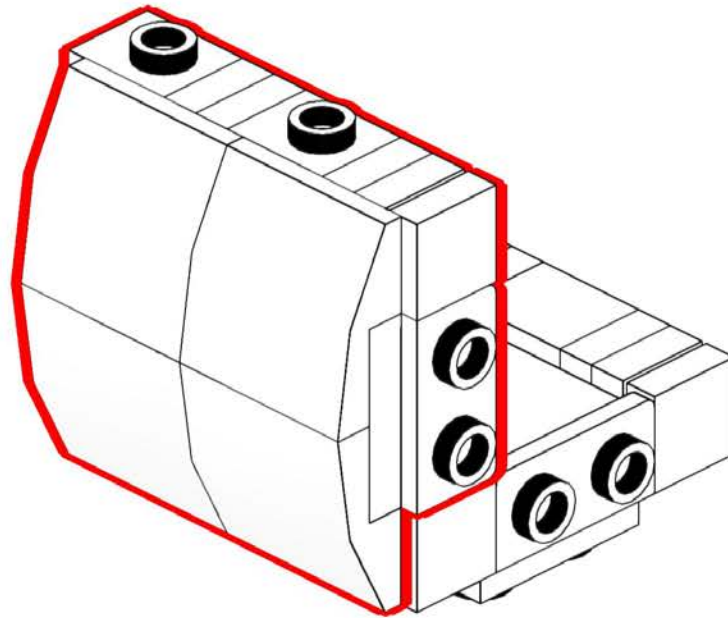

# 92

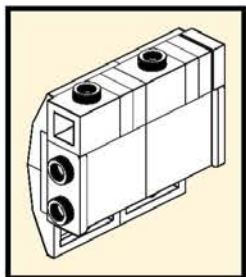
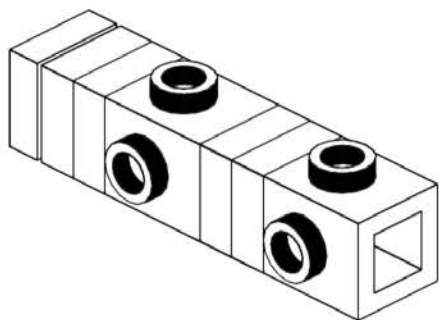
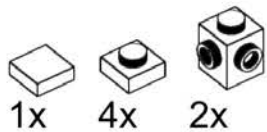

# 93

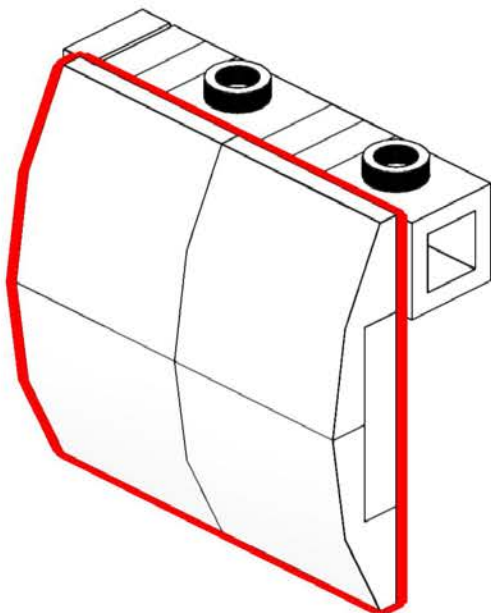
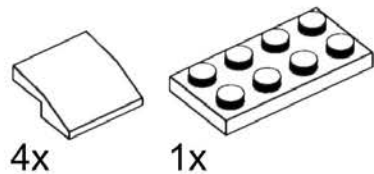

# 94

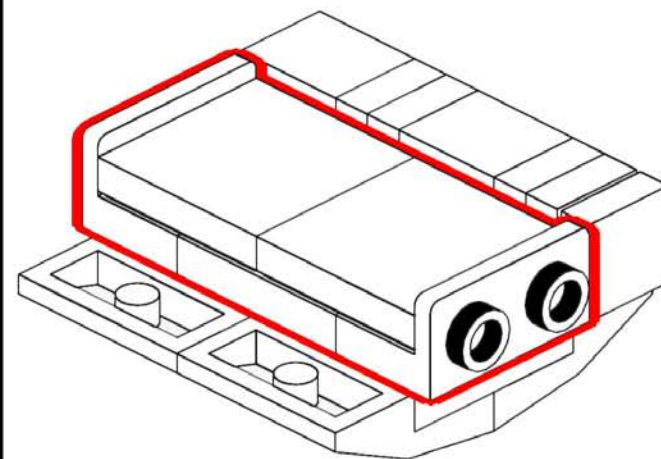
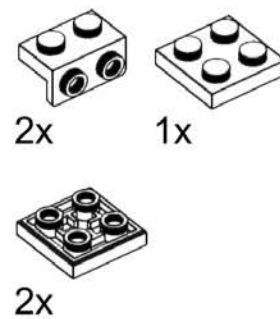

# 95

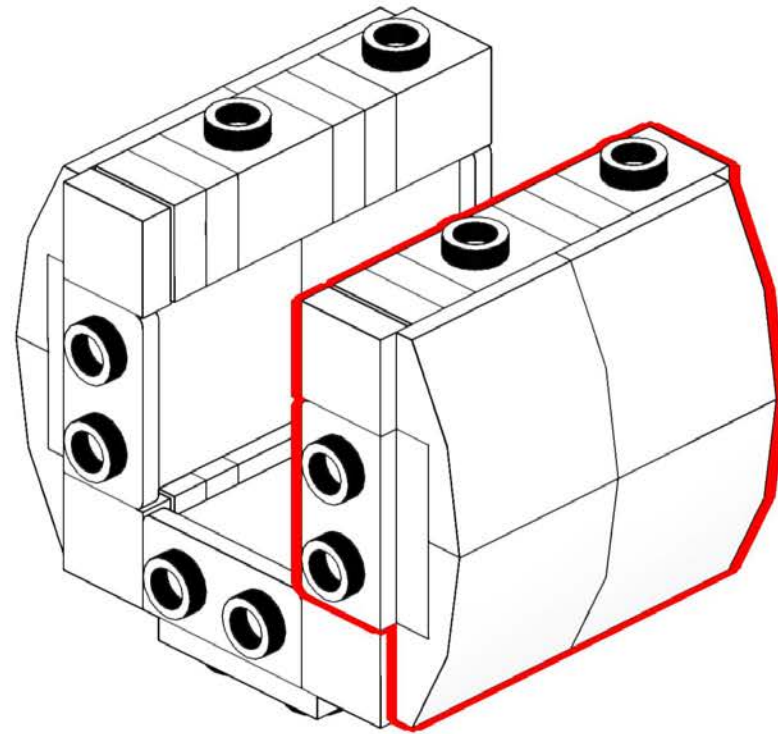

# 96

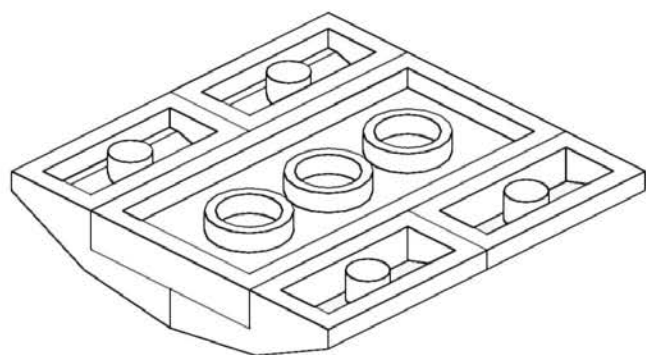
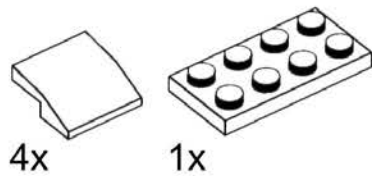

# 97

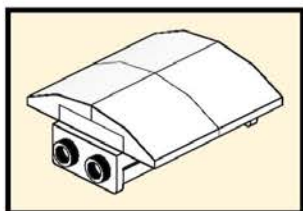
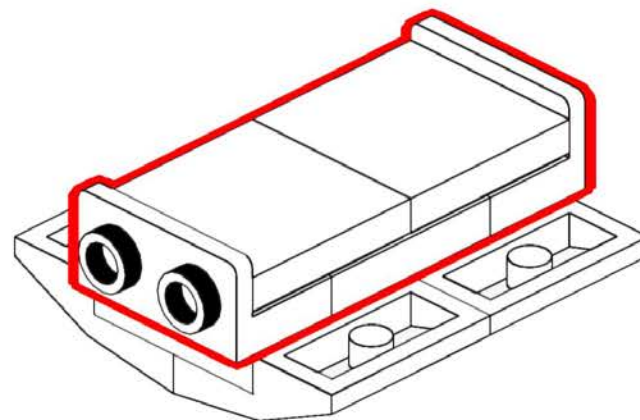
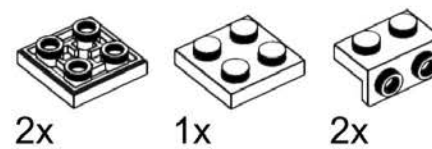



# 98

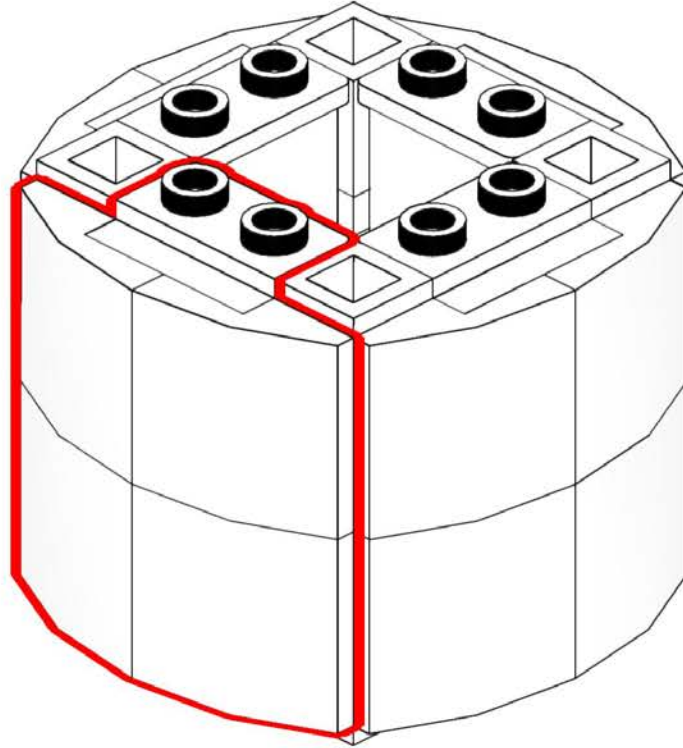

# 99



4x

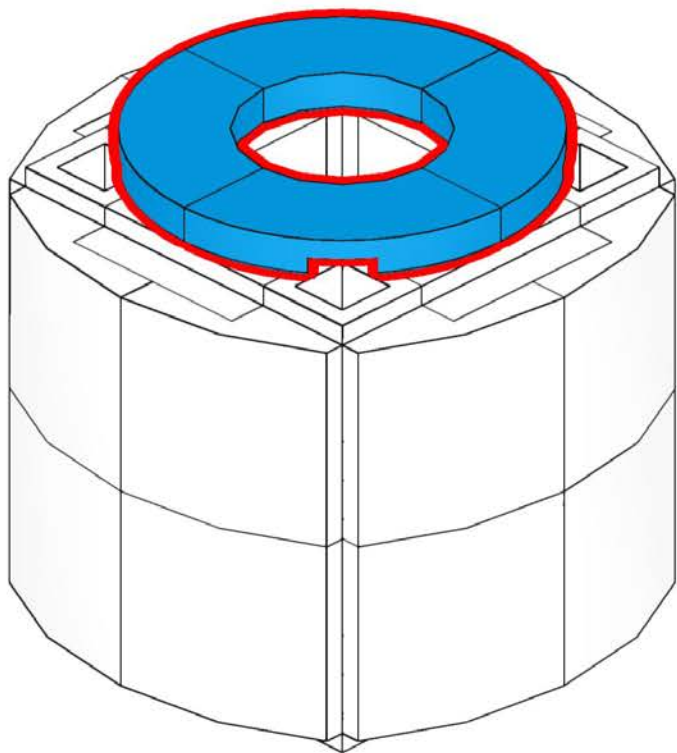

# 100



4x



4x

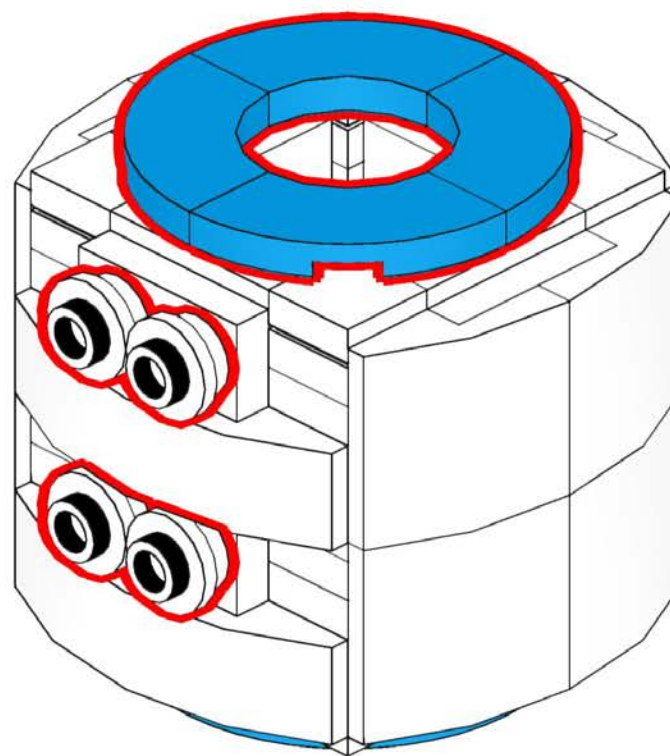

101

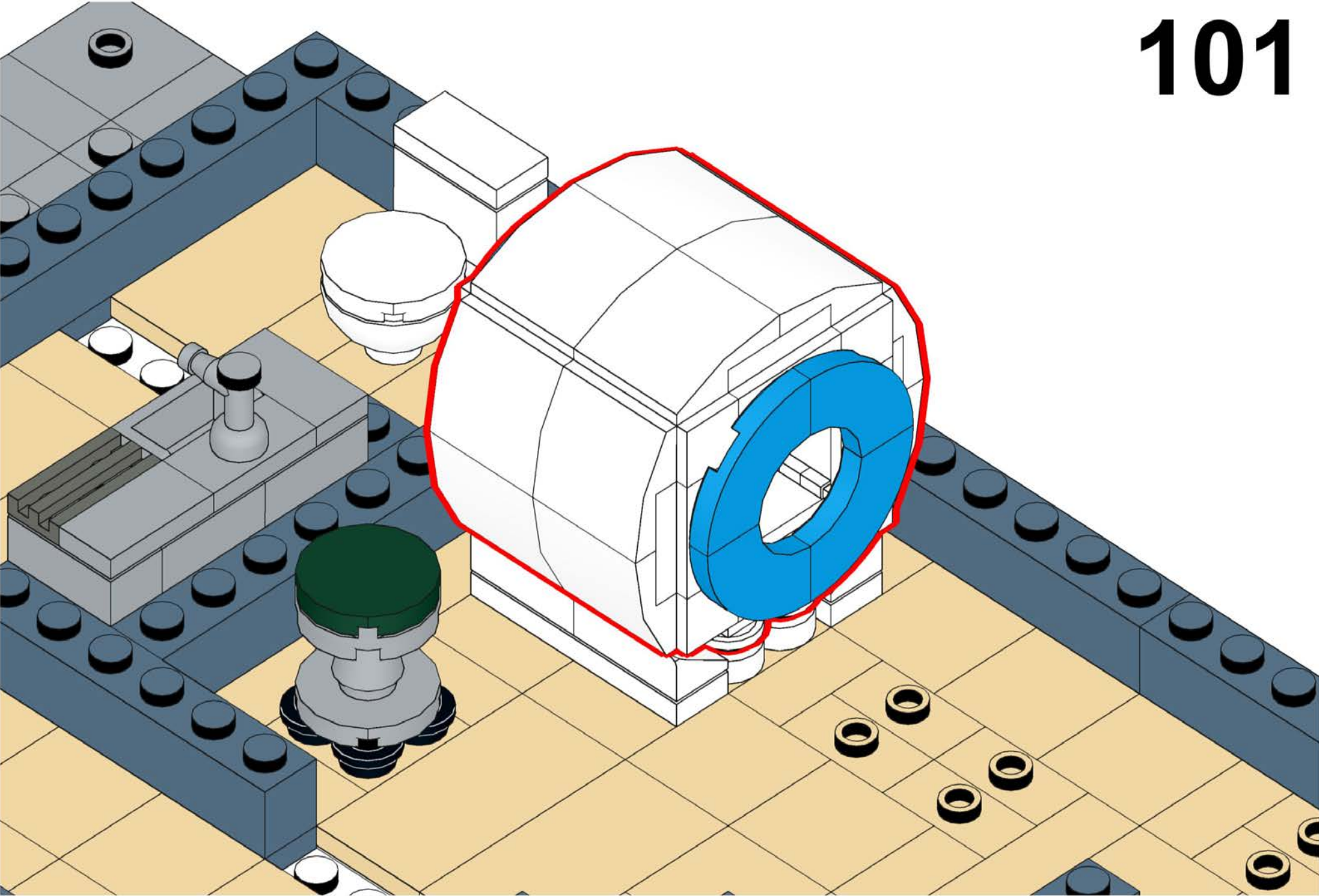



# 102

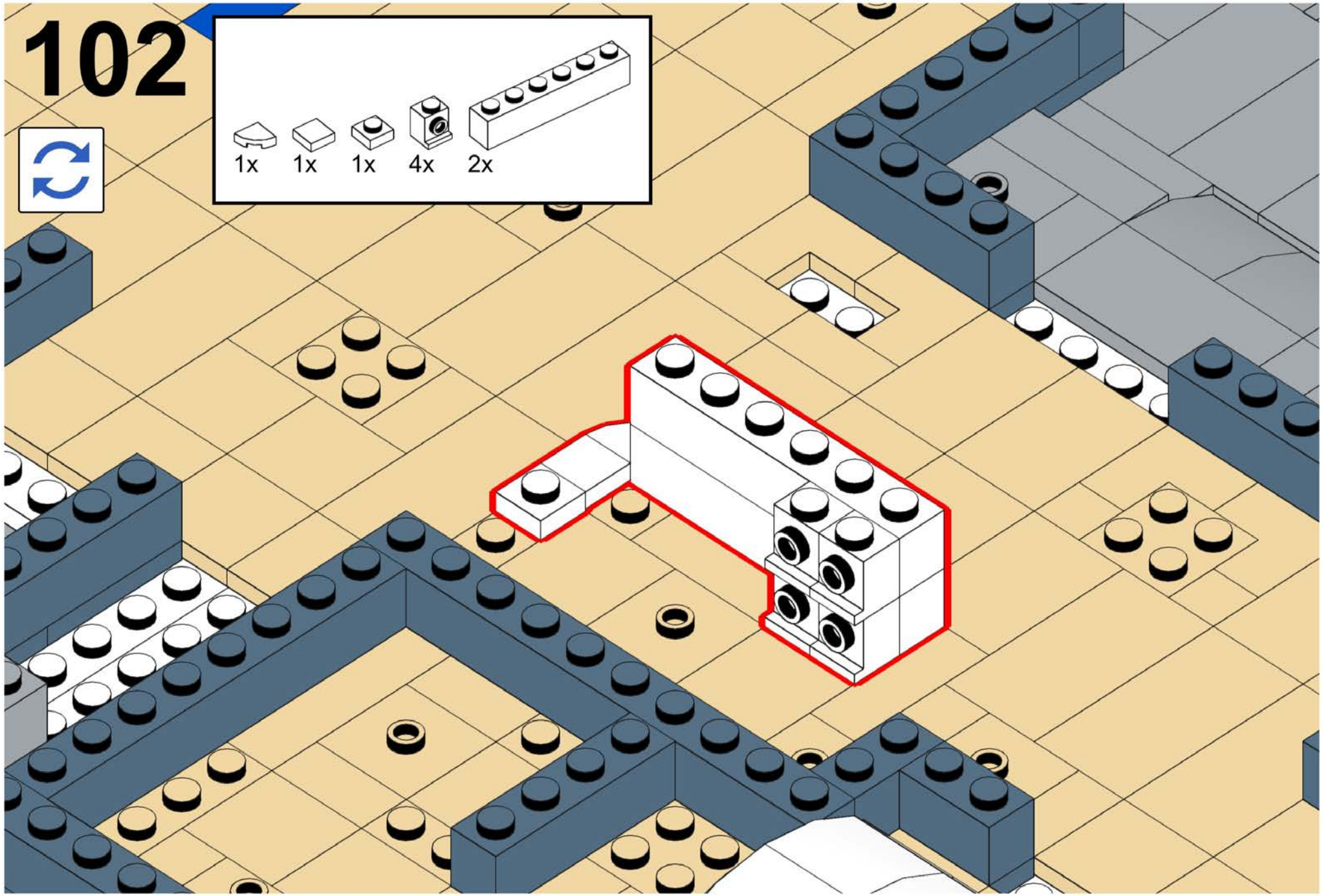

1x	1x	1x	4x	2x



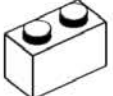

# 103

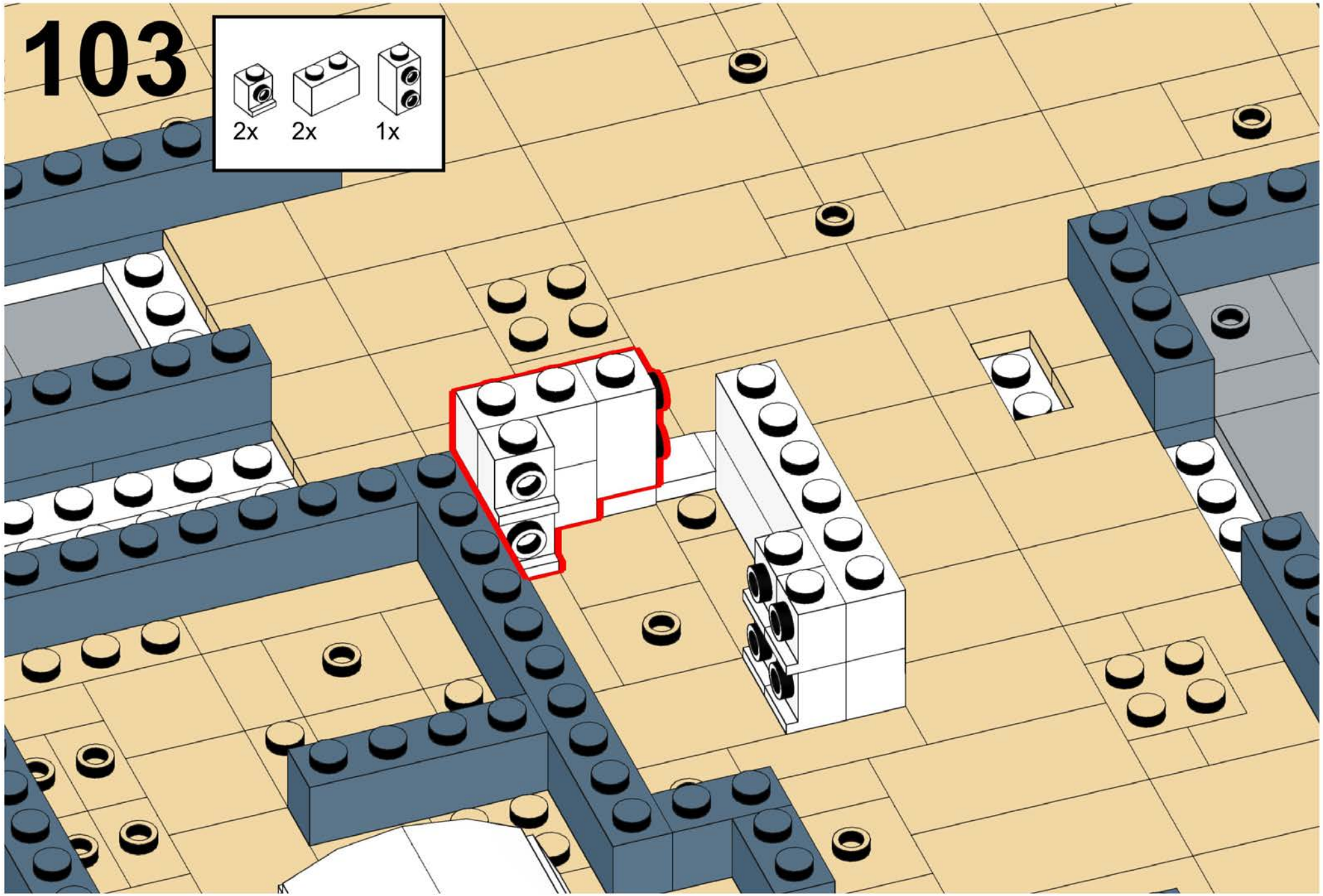
		
2x	2x	1x



# 104



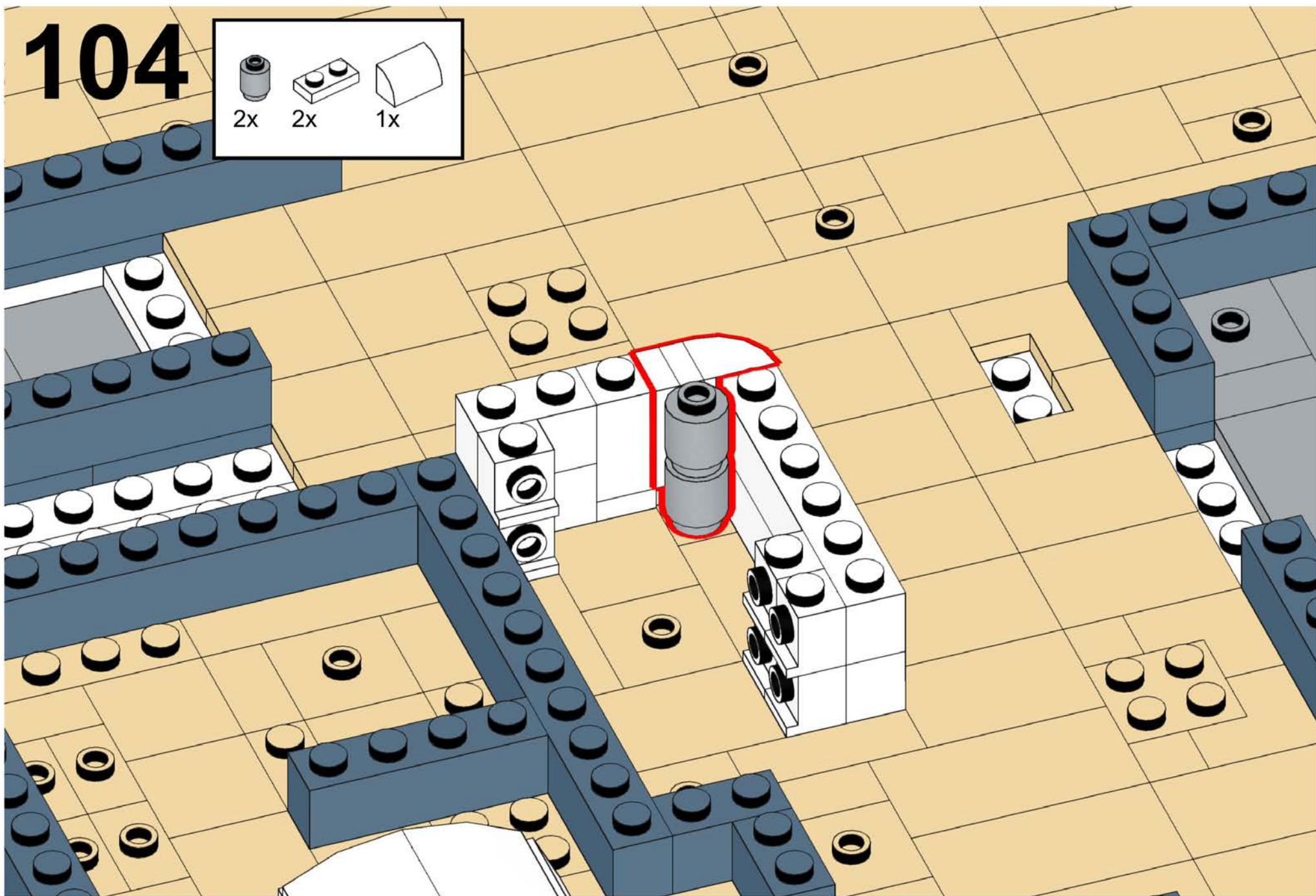

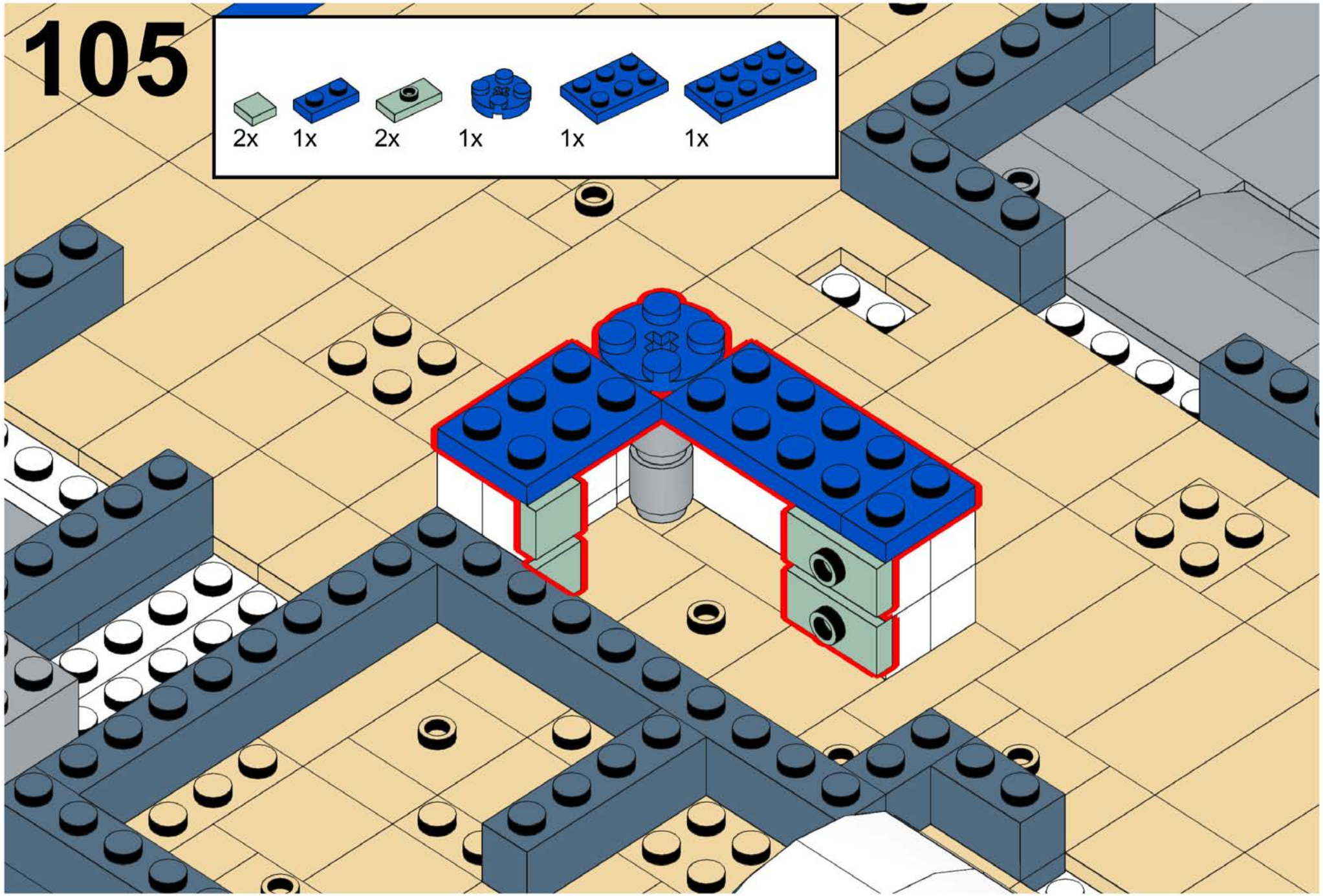
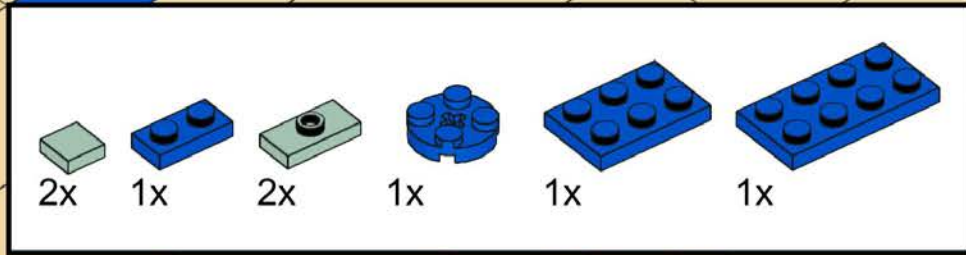

		
2x	2x	1x



# 105







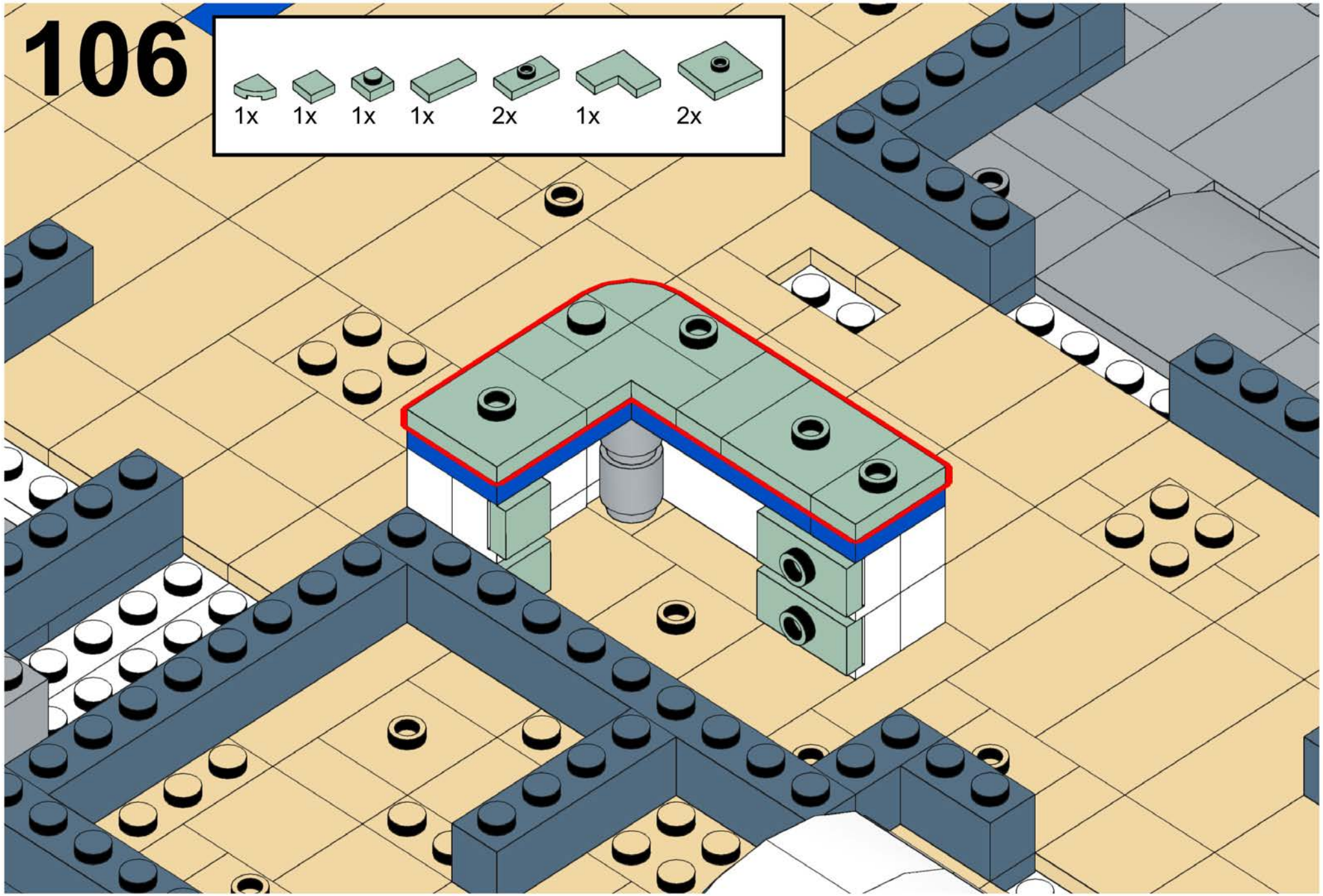





# 106

						
1x	1x	1x	1x	2x	1x	2x







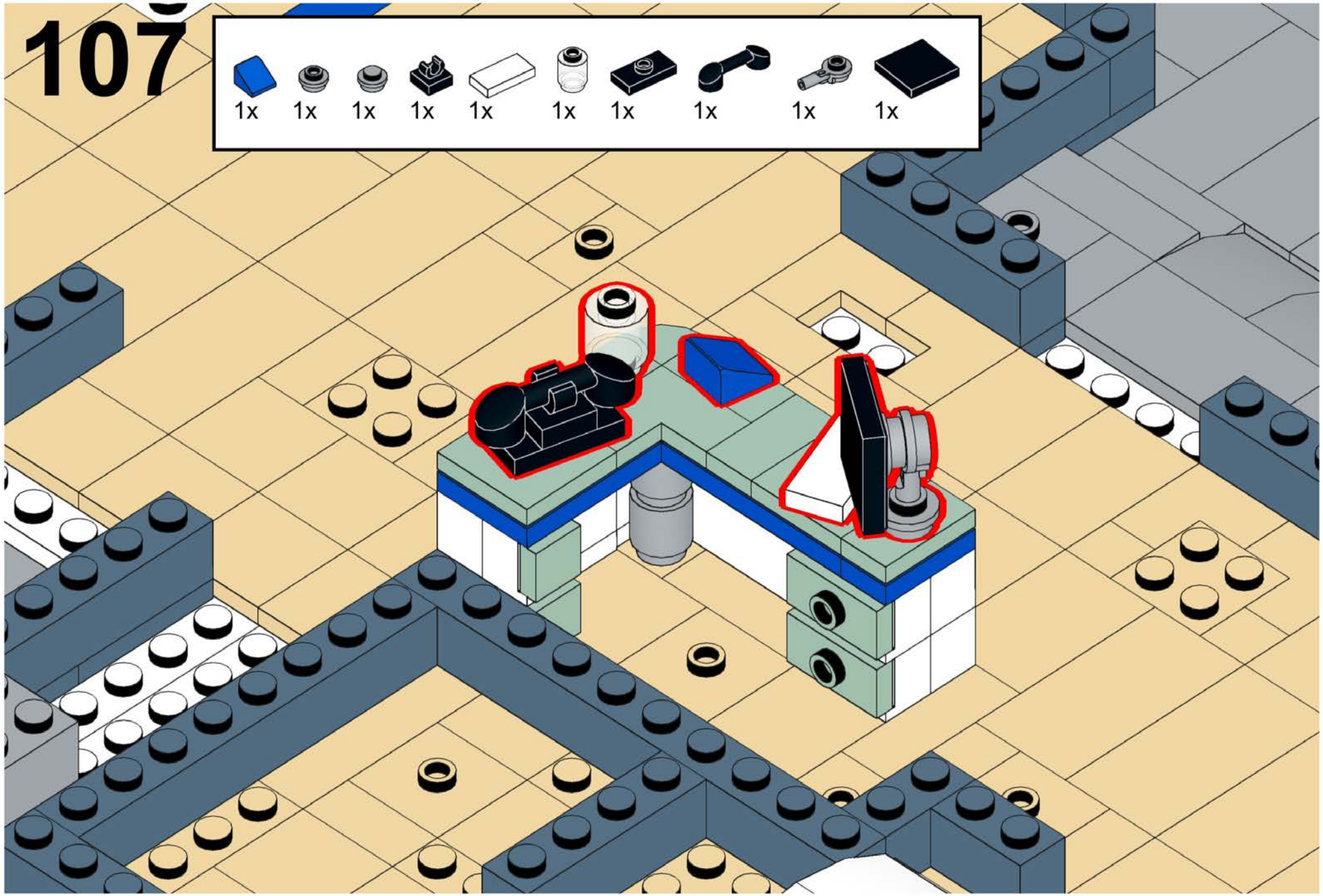

# 107

- 1x 
- 1x 
- 1x 
- 1x 
- 1x 
- 1x 
- 1x 
- 1x 
- 1x 
- 1x 



# 108

			
1x	1x	1x	1x

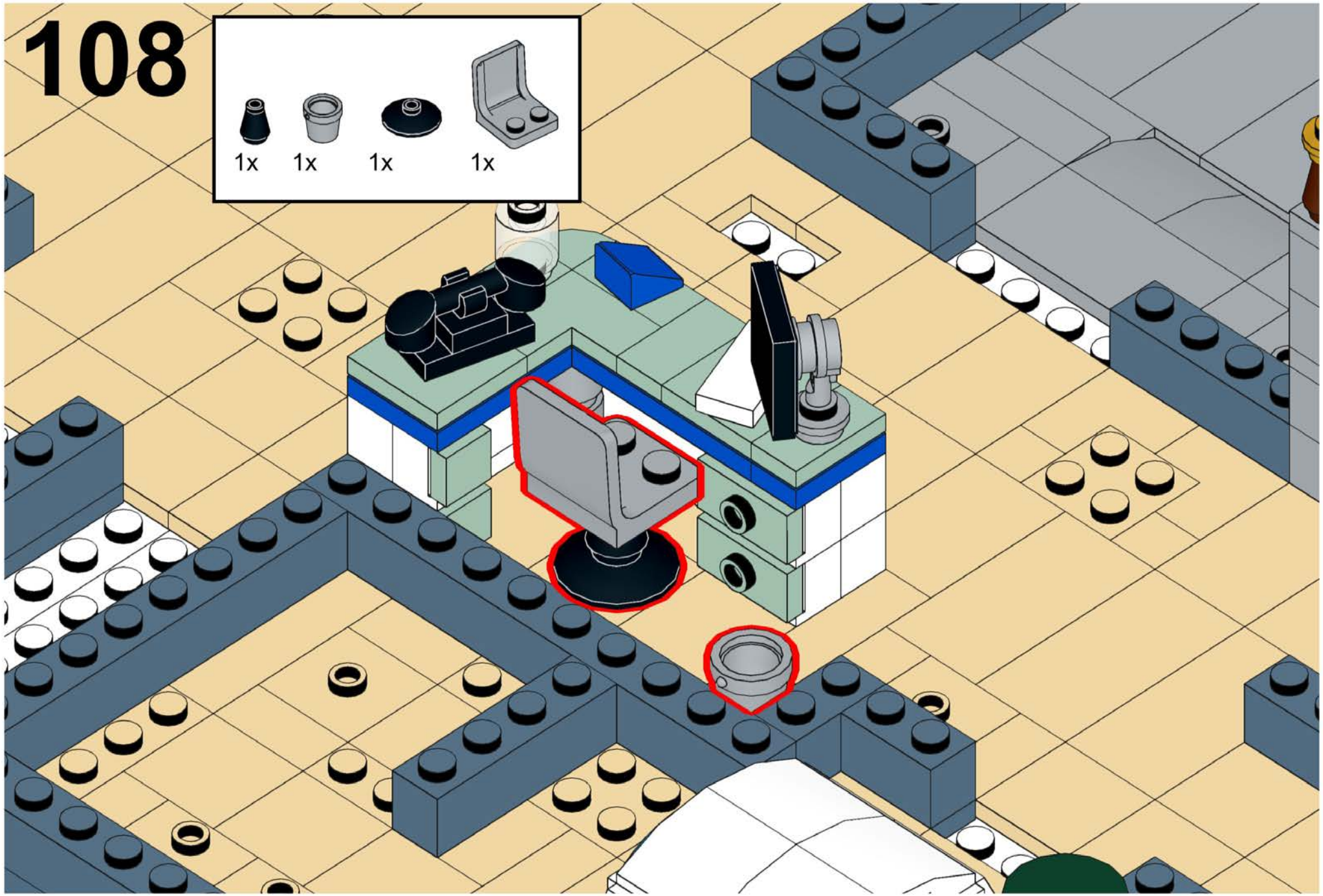

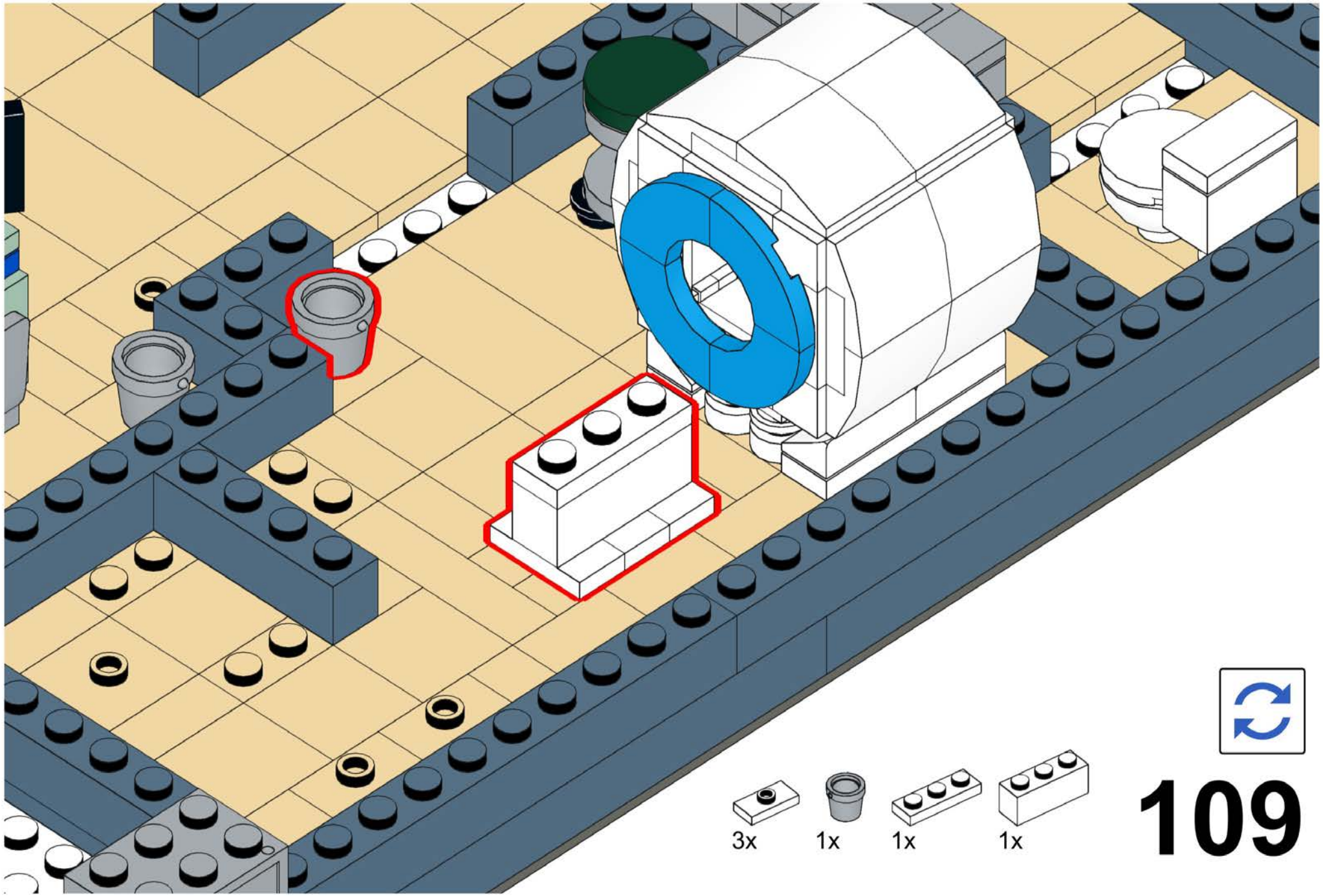

3x

1x

1x

1x

  
**109**

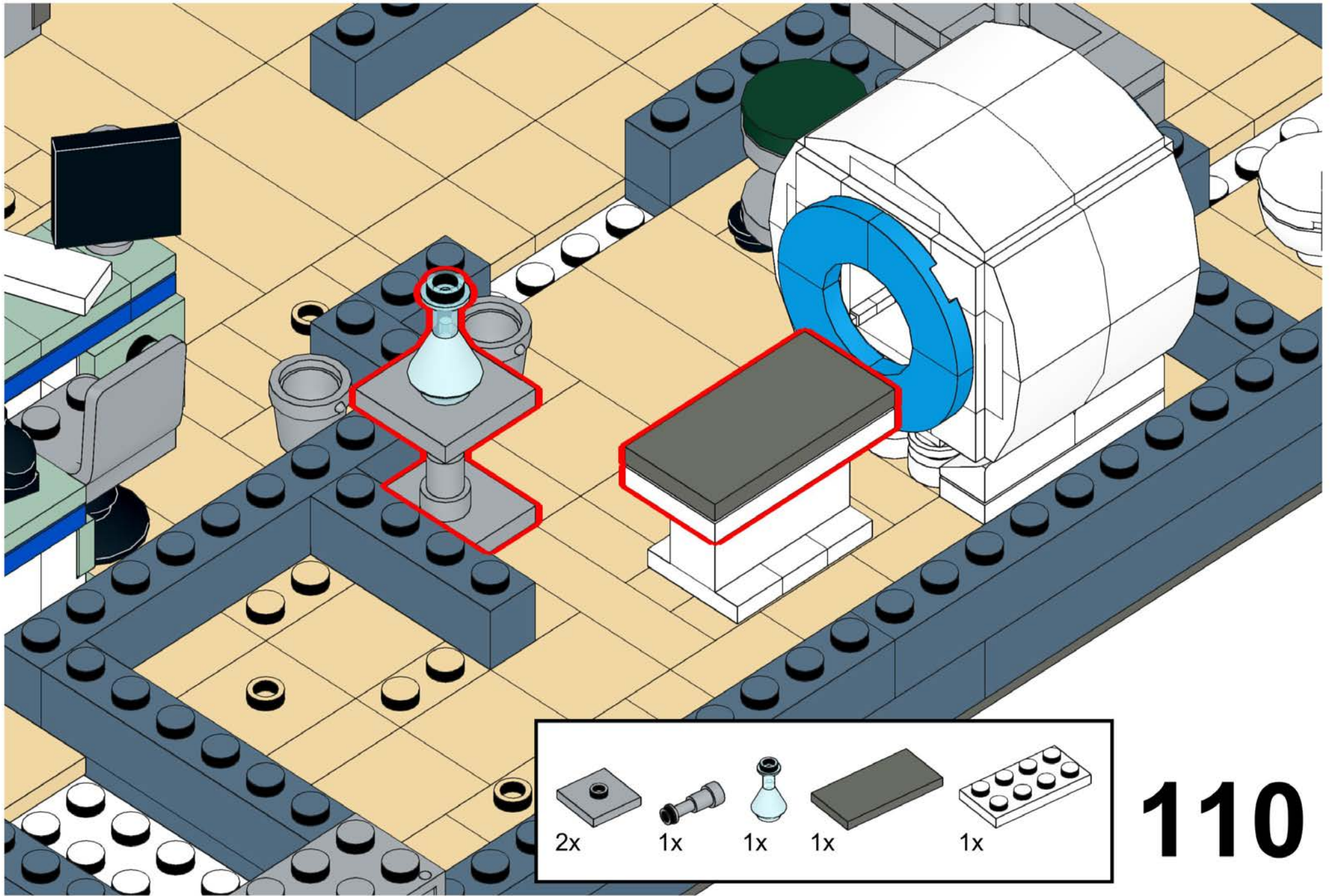

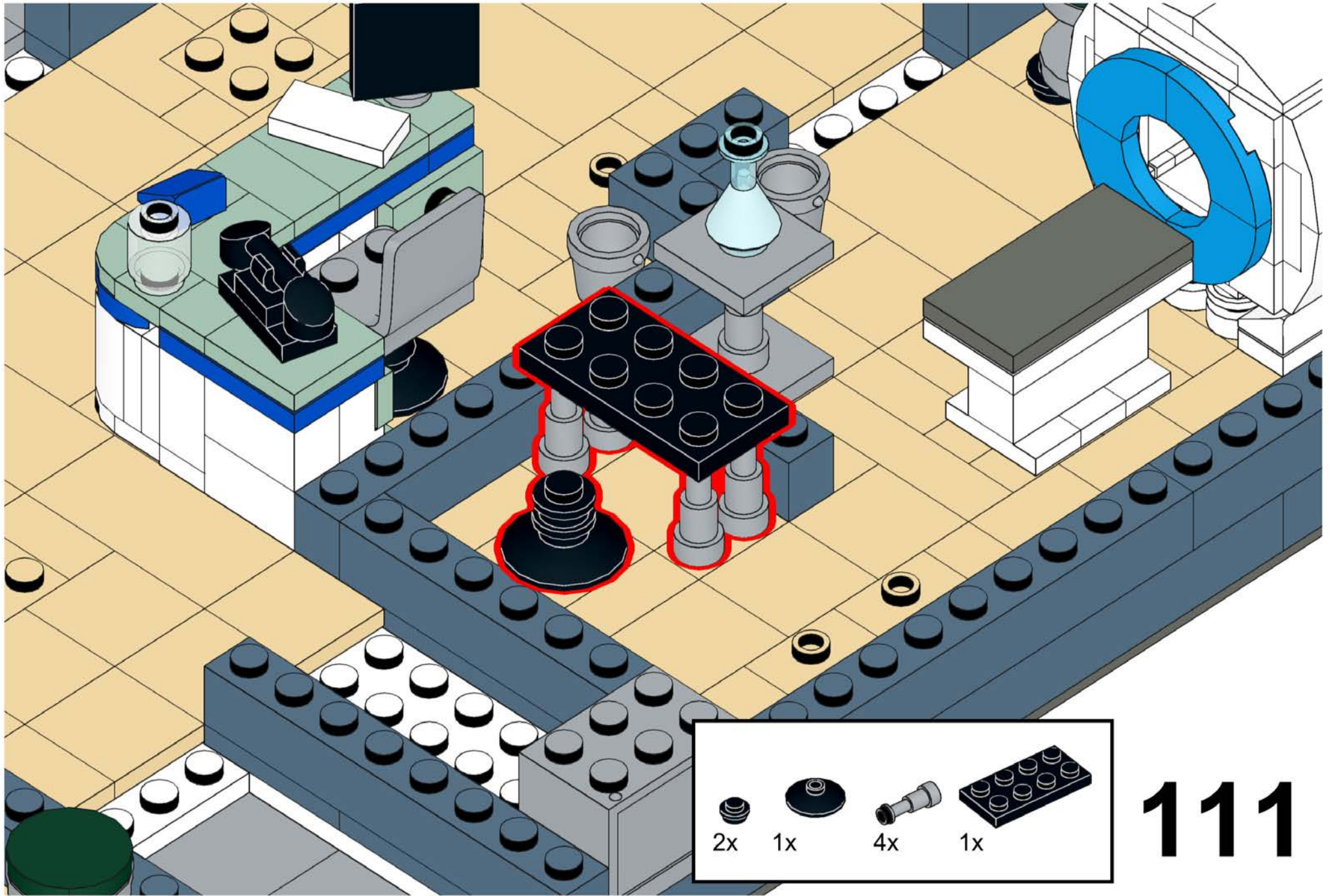

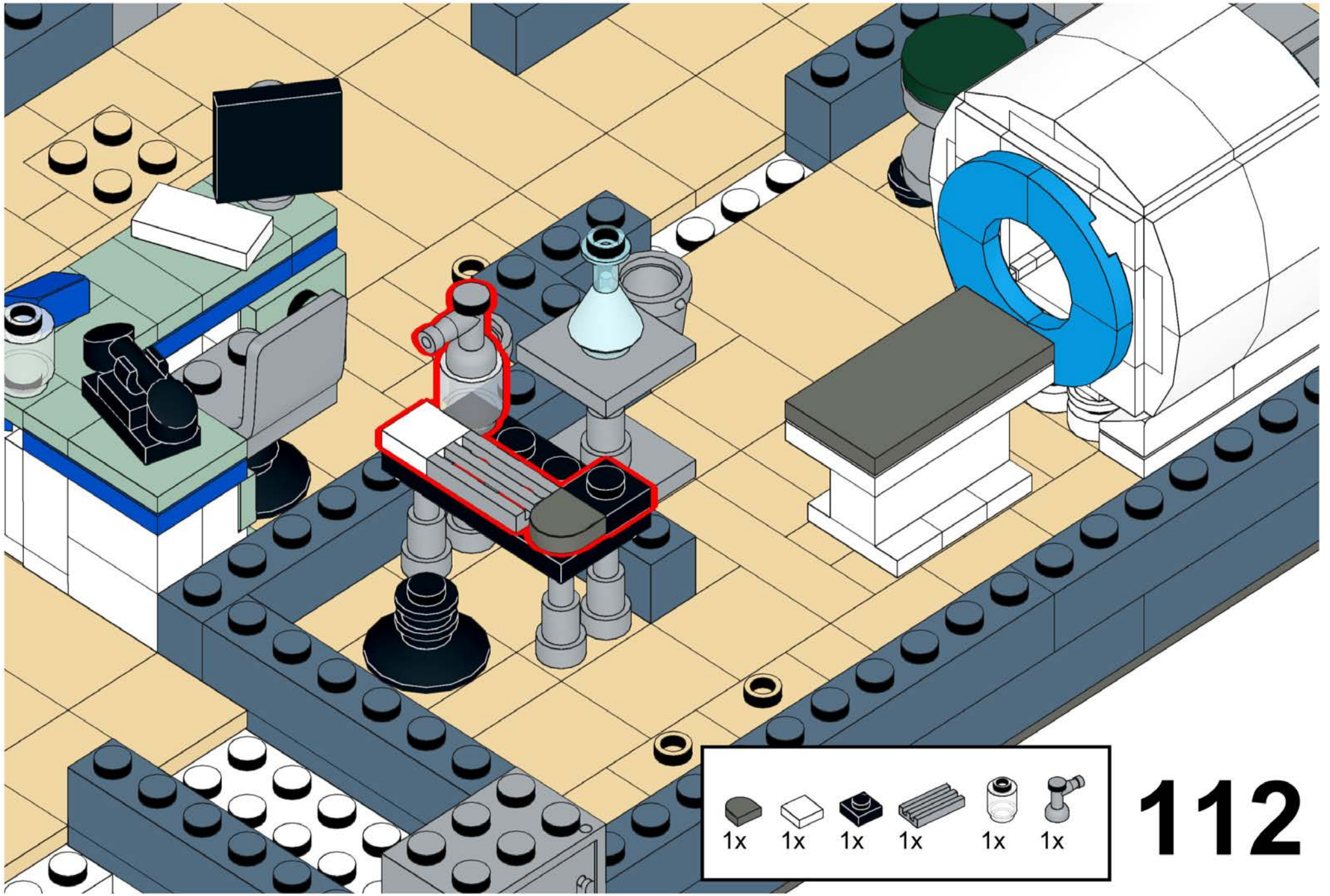

- 1x
- 1x
- 1x
- 1x
- 1x
- 1x

**112**

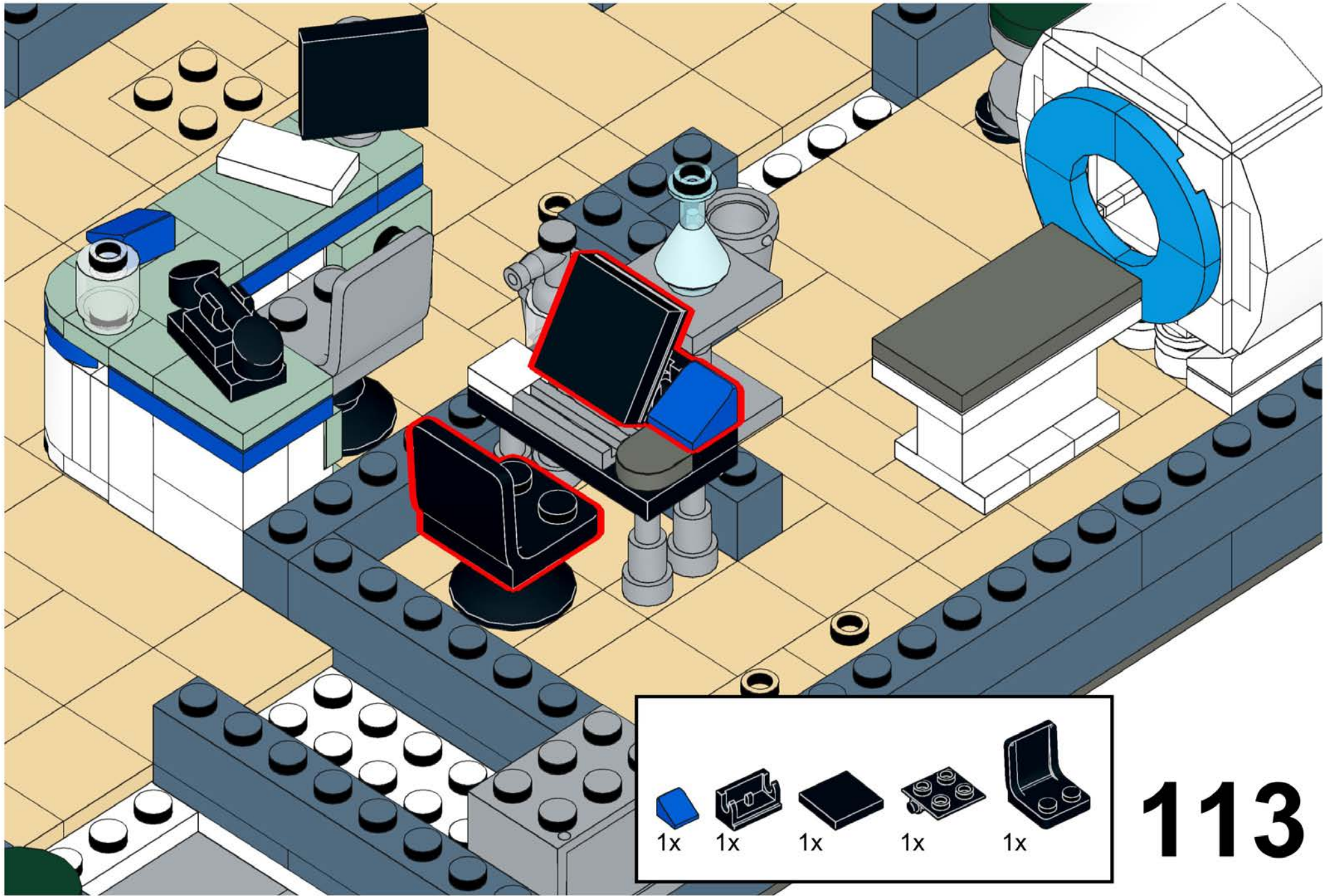

- 1x 
- 1x 
- 1x 
- 1x 
- 1x 

113

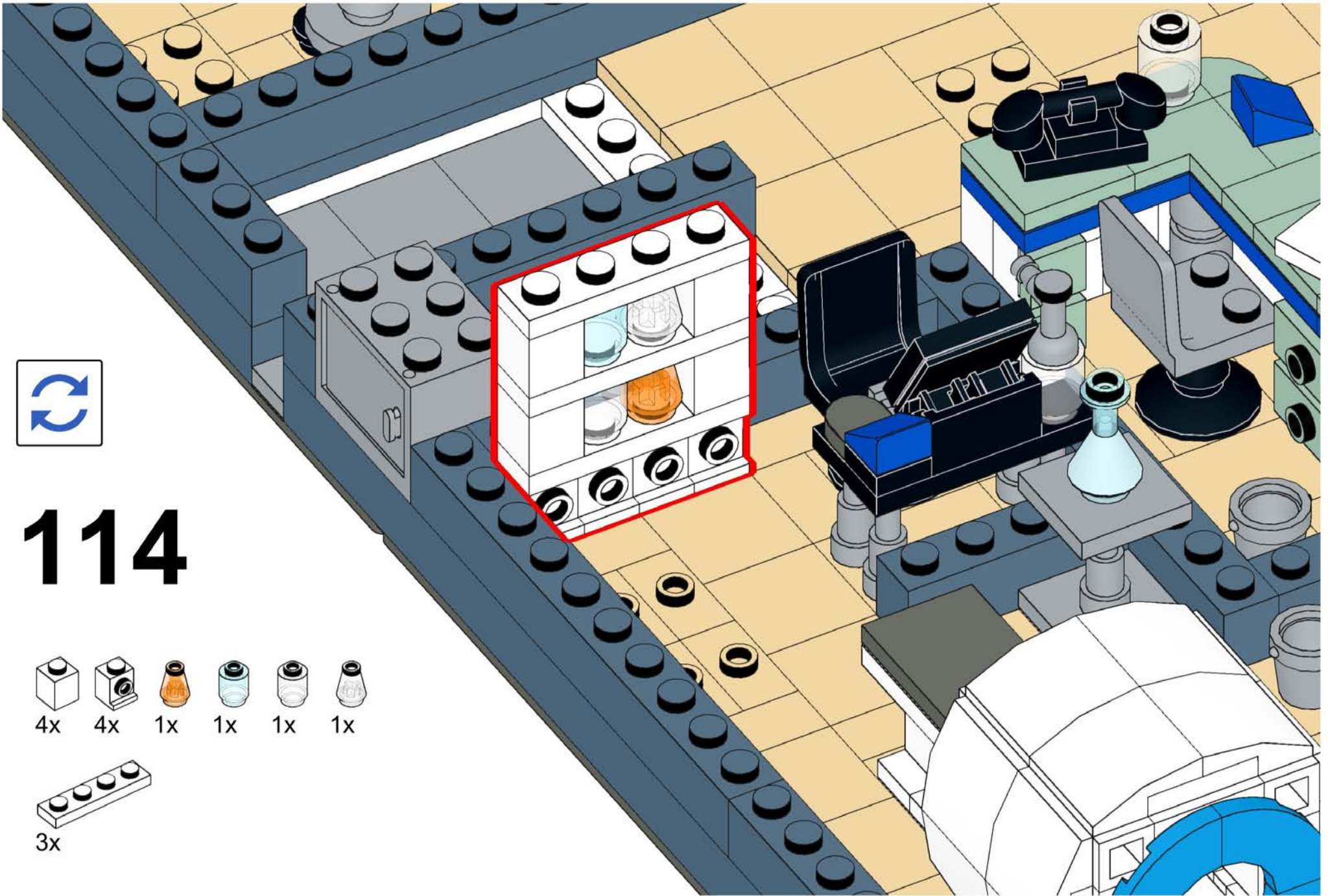

114

- 4x
- 4x
- 1x
- 1x
- 1x
- 1x

- 3x



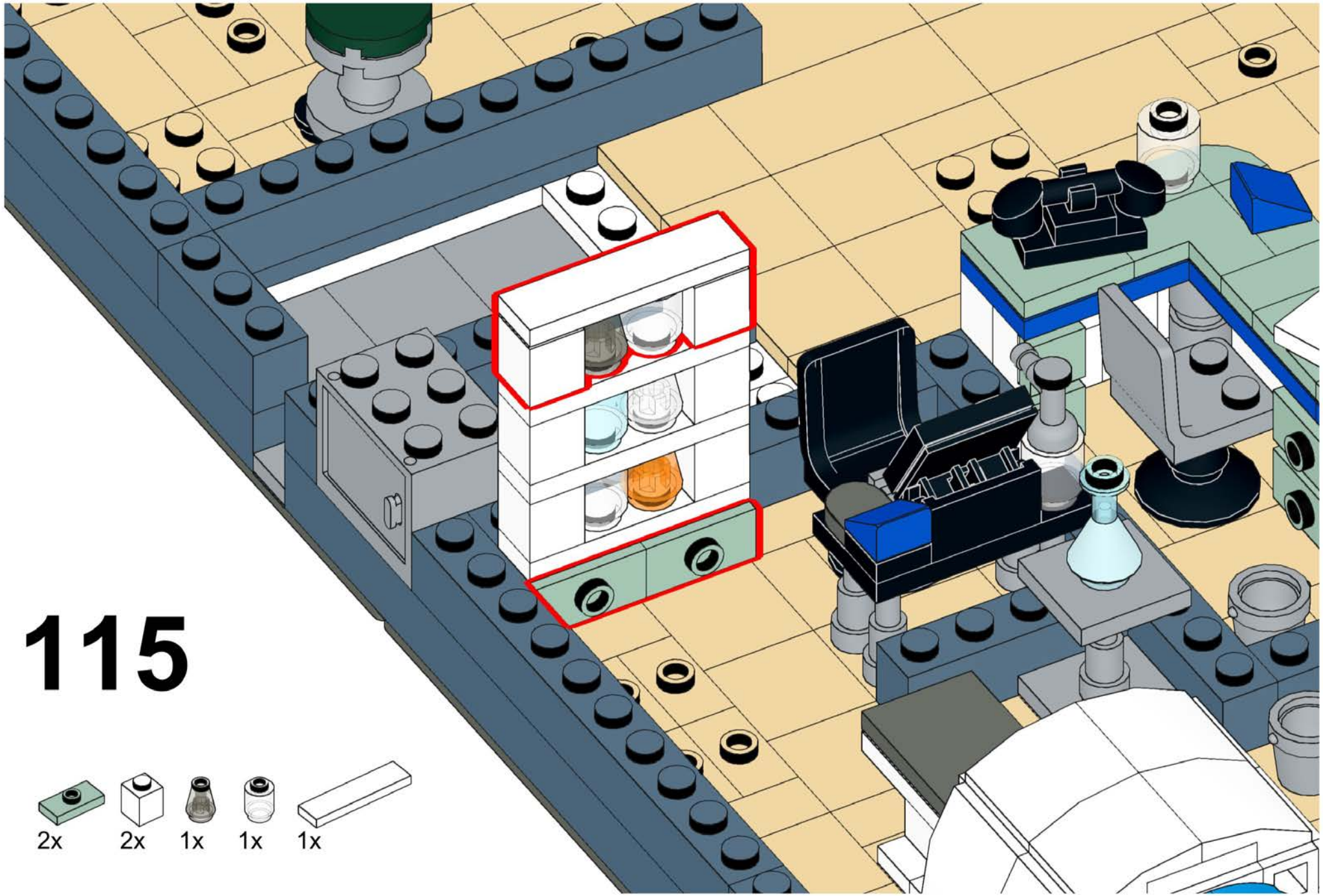

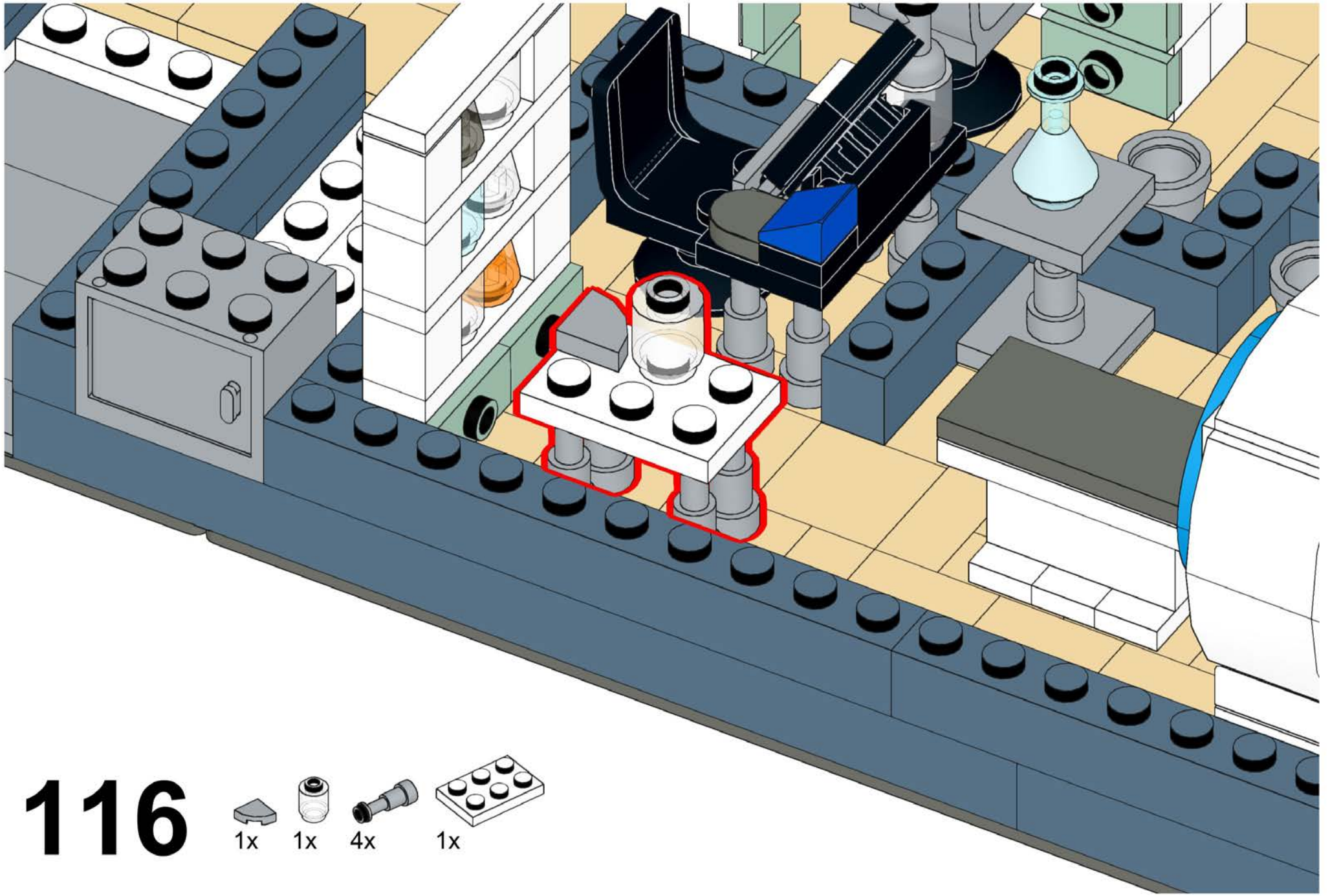

116

- 1x 
- 1x 
- 4x 
- 1x 

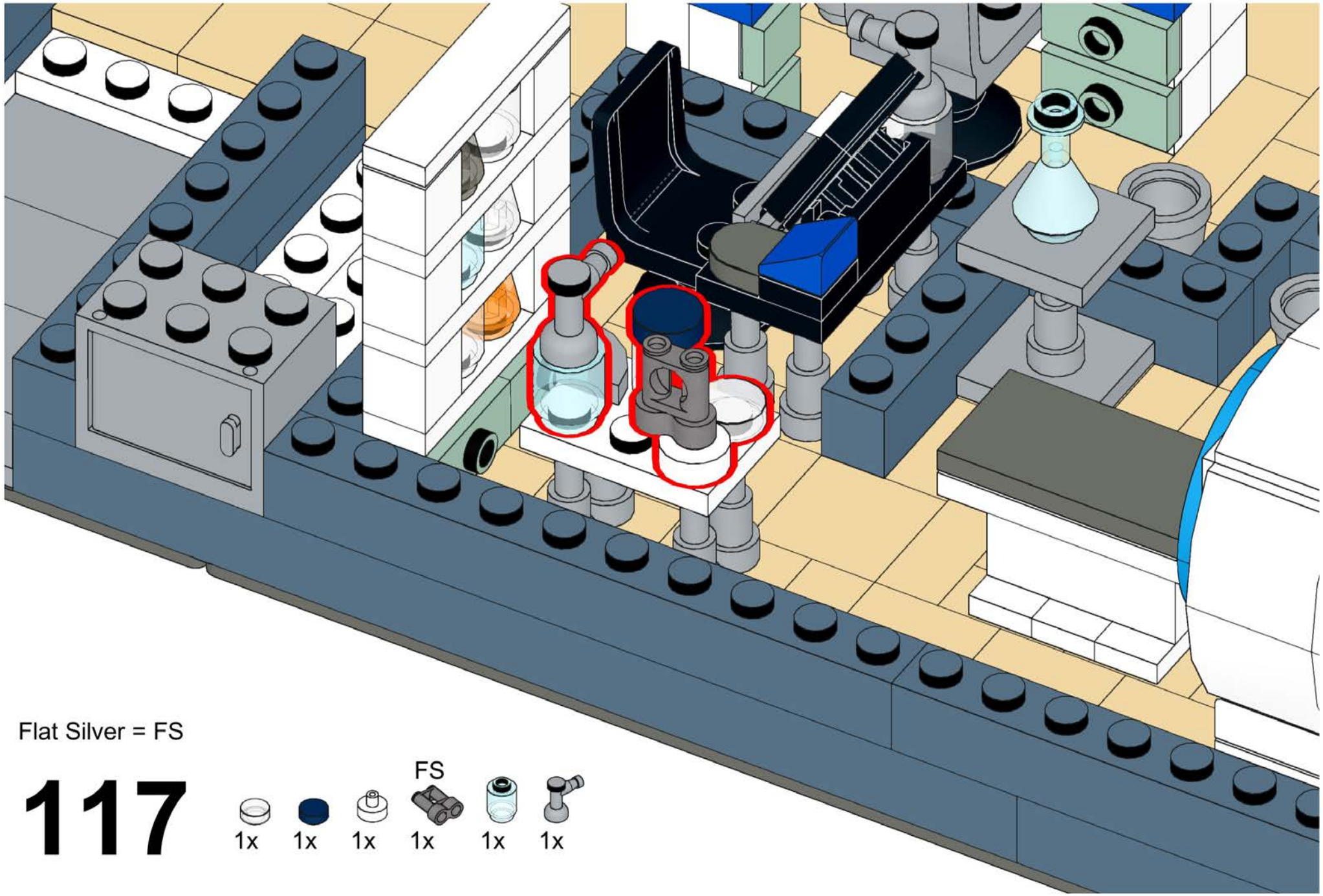

Flat Silver = FS

# 117



1x



1x



1x



1x



1x



1x



1x

# 118

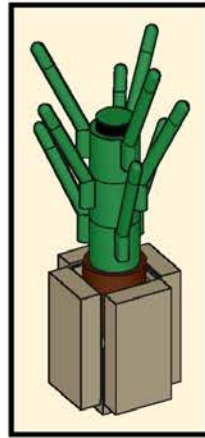
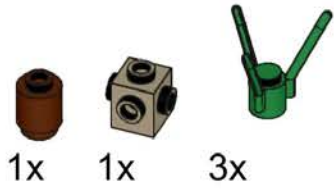



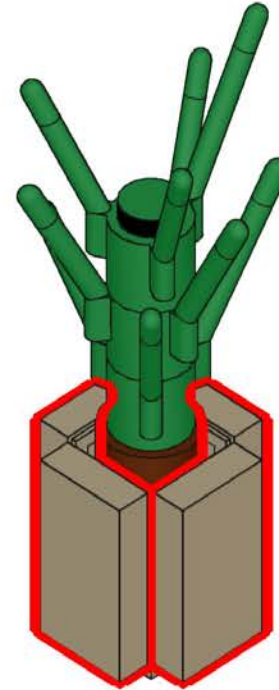
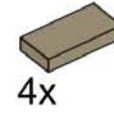

# 119

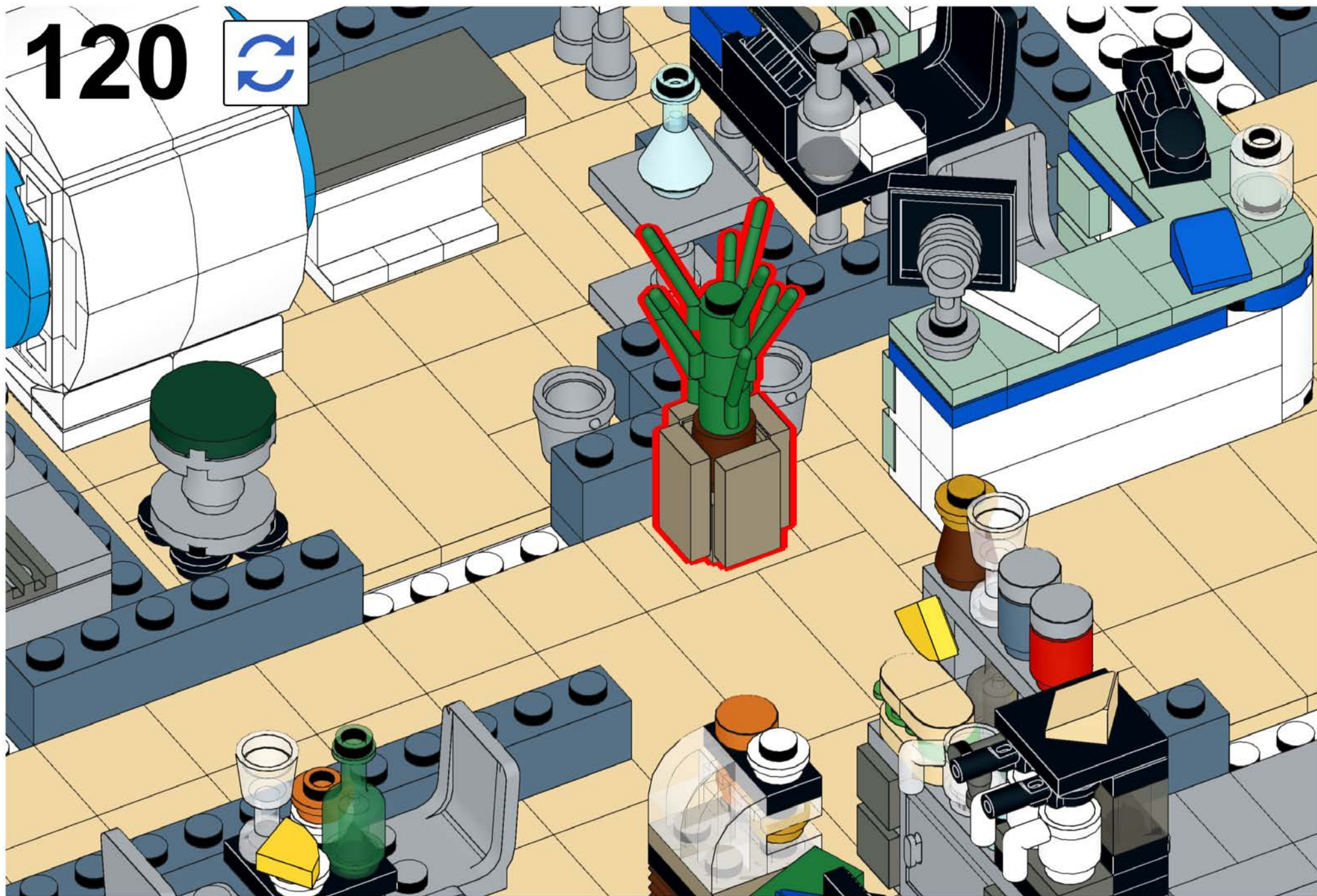

120

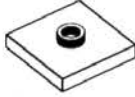

# 121

-  1x
-  1x
-  1x
-  1x
-  1x

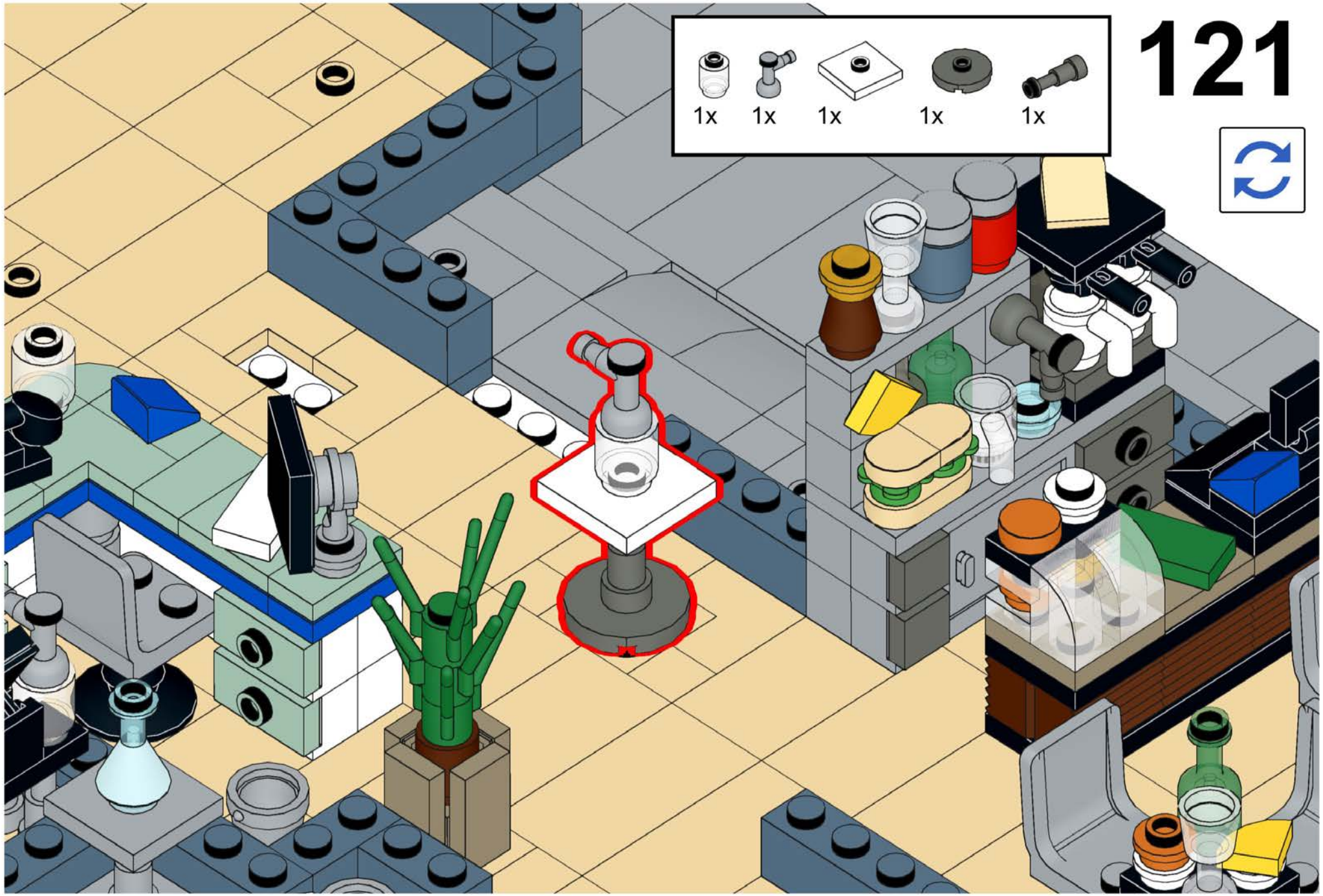

# 122

- 1x
- 1x
- 1x
- 1x
- 1x
- 1x

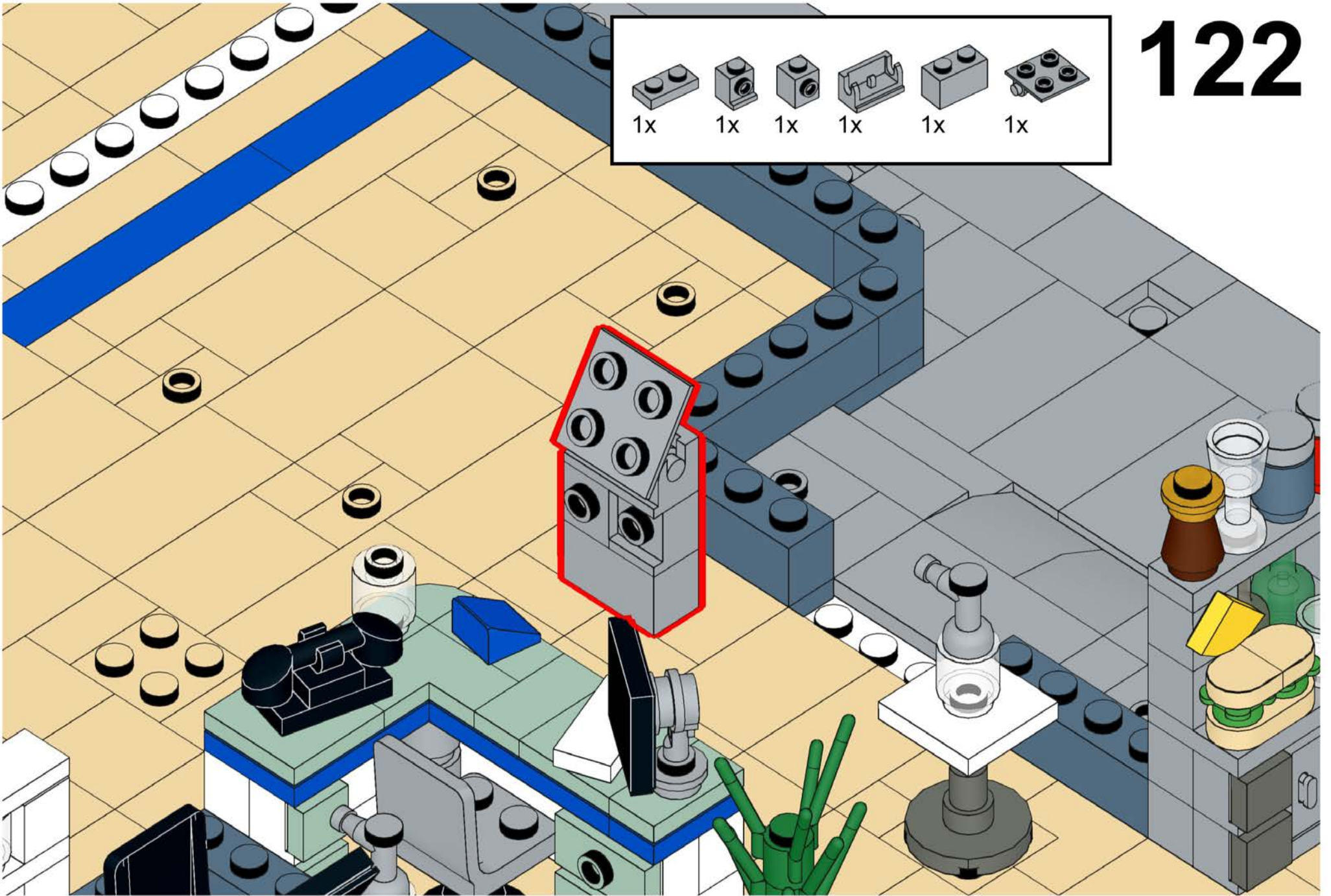
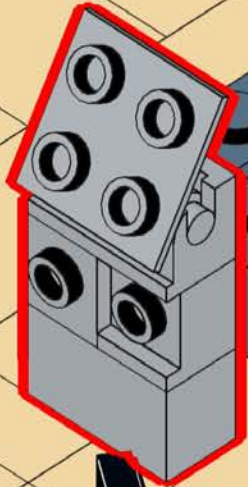

# 123

1x 1x 1x

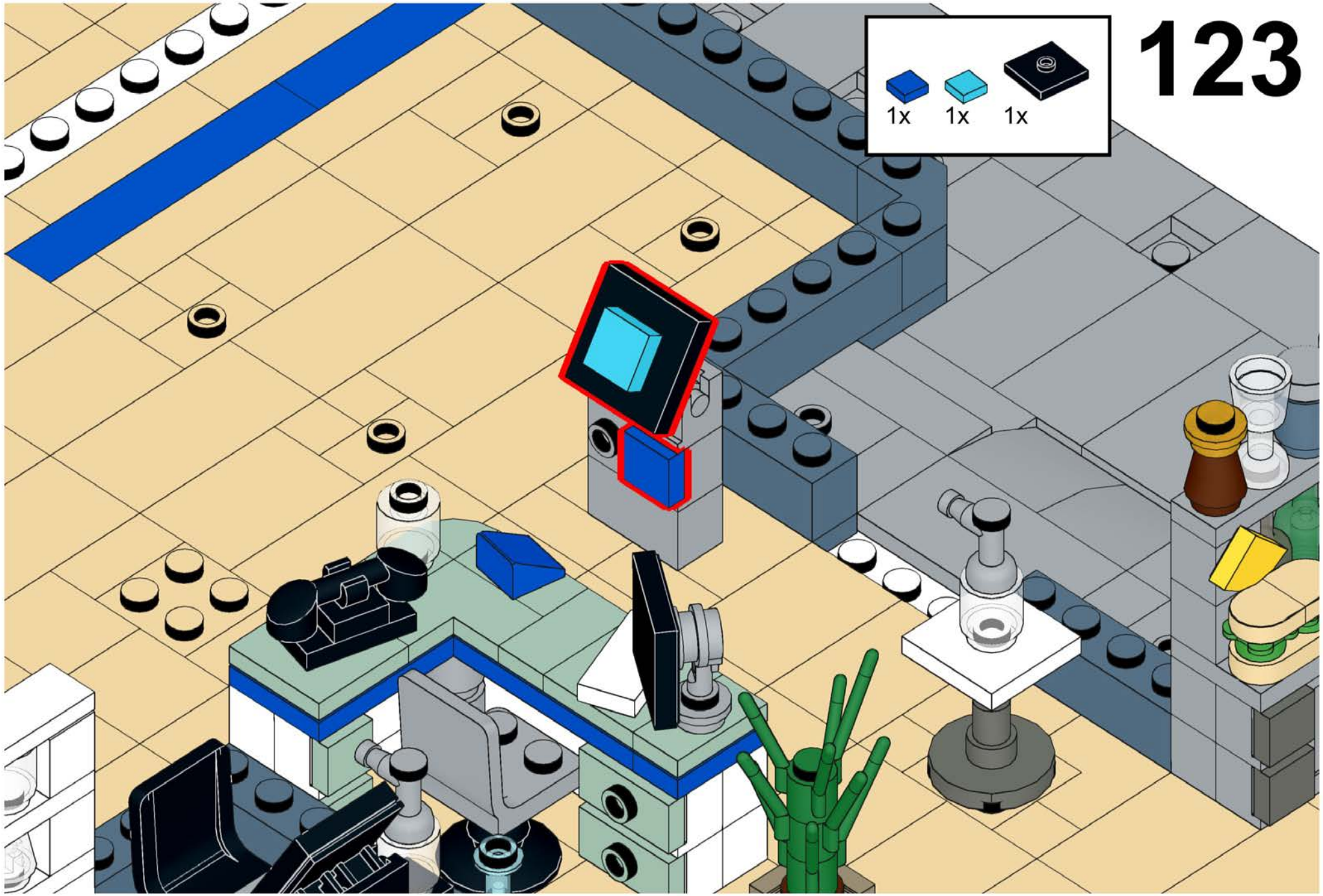
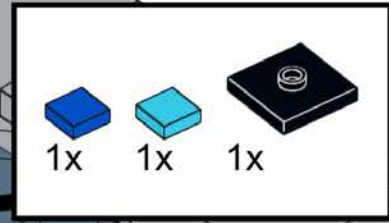



# 124

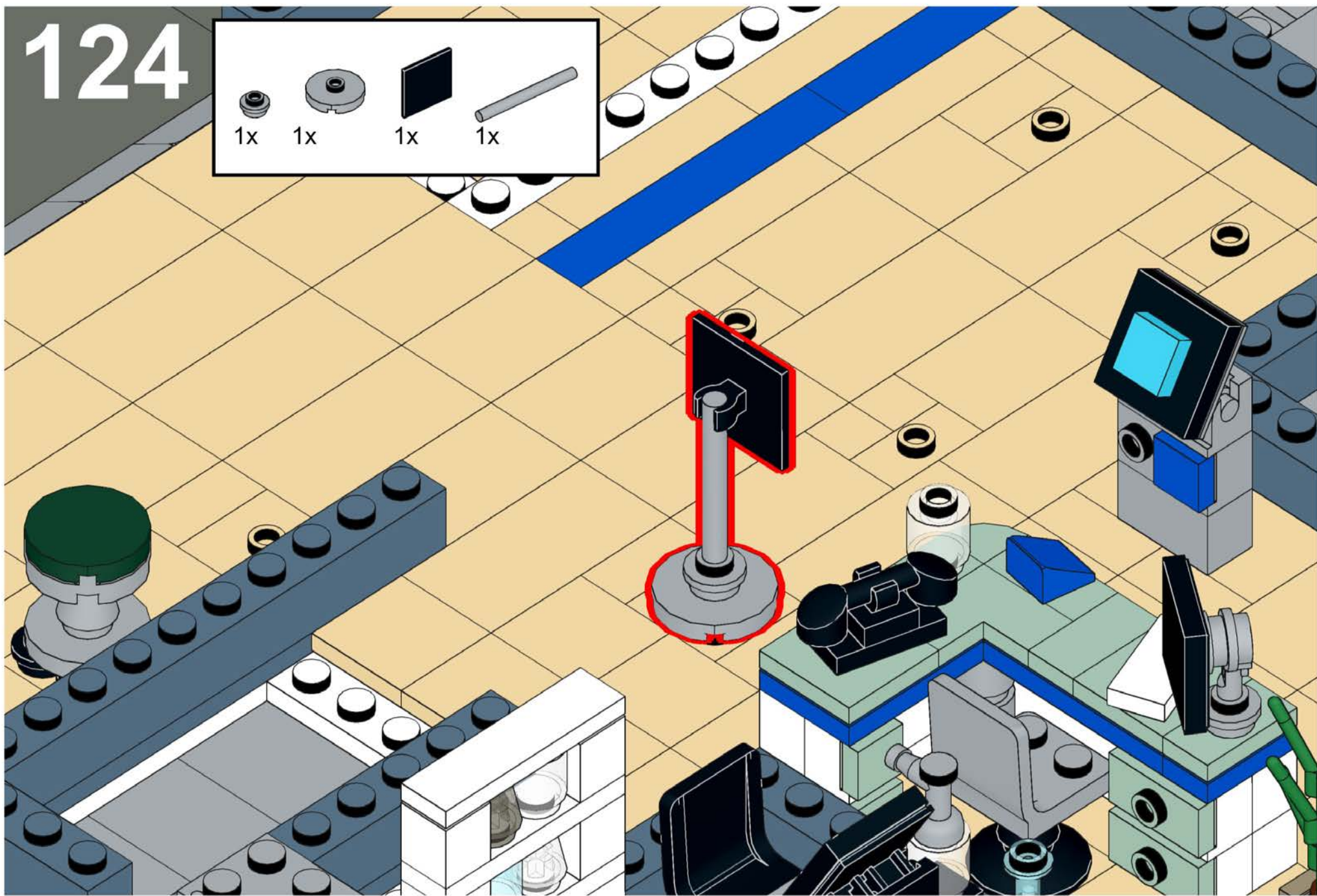
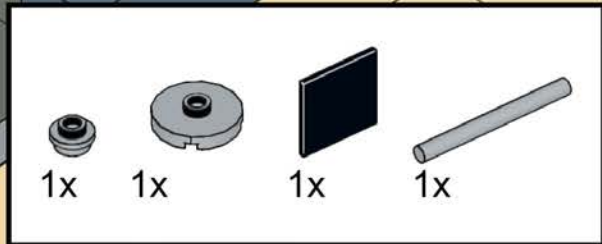

# 125

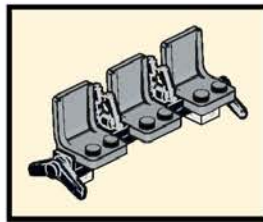

2x

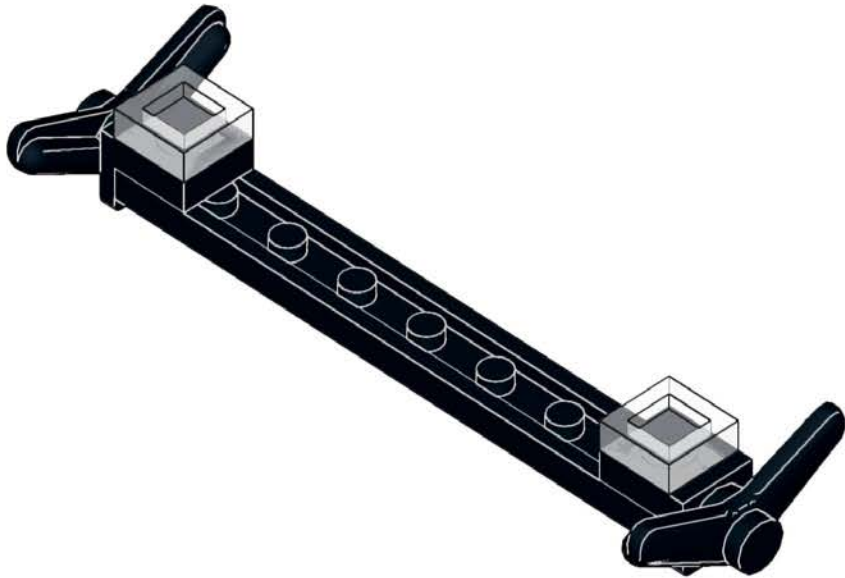

# 126

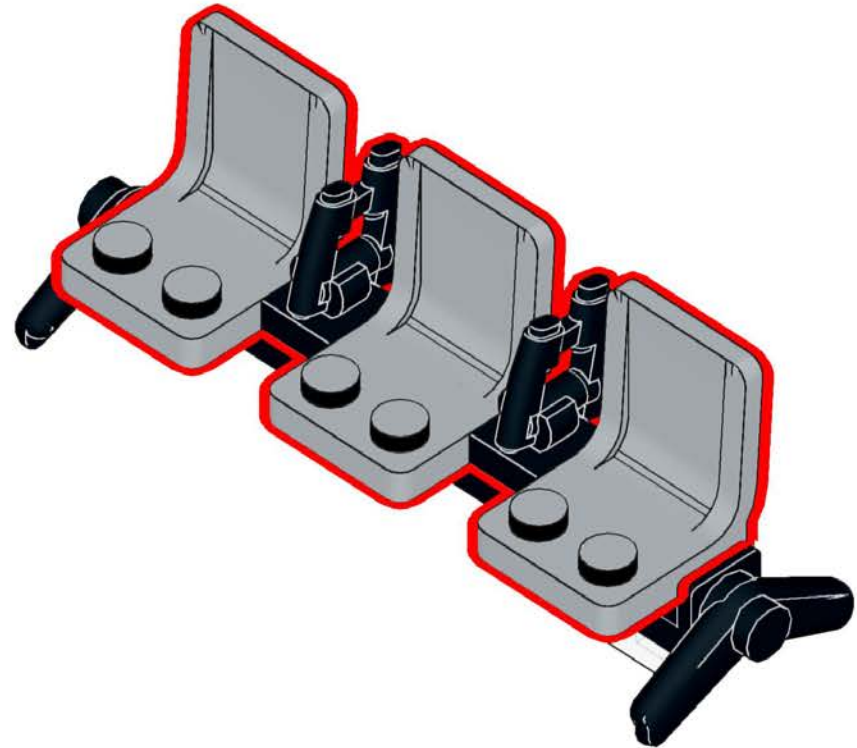
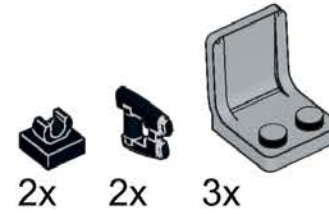

# 127

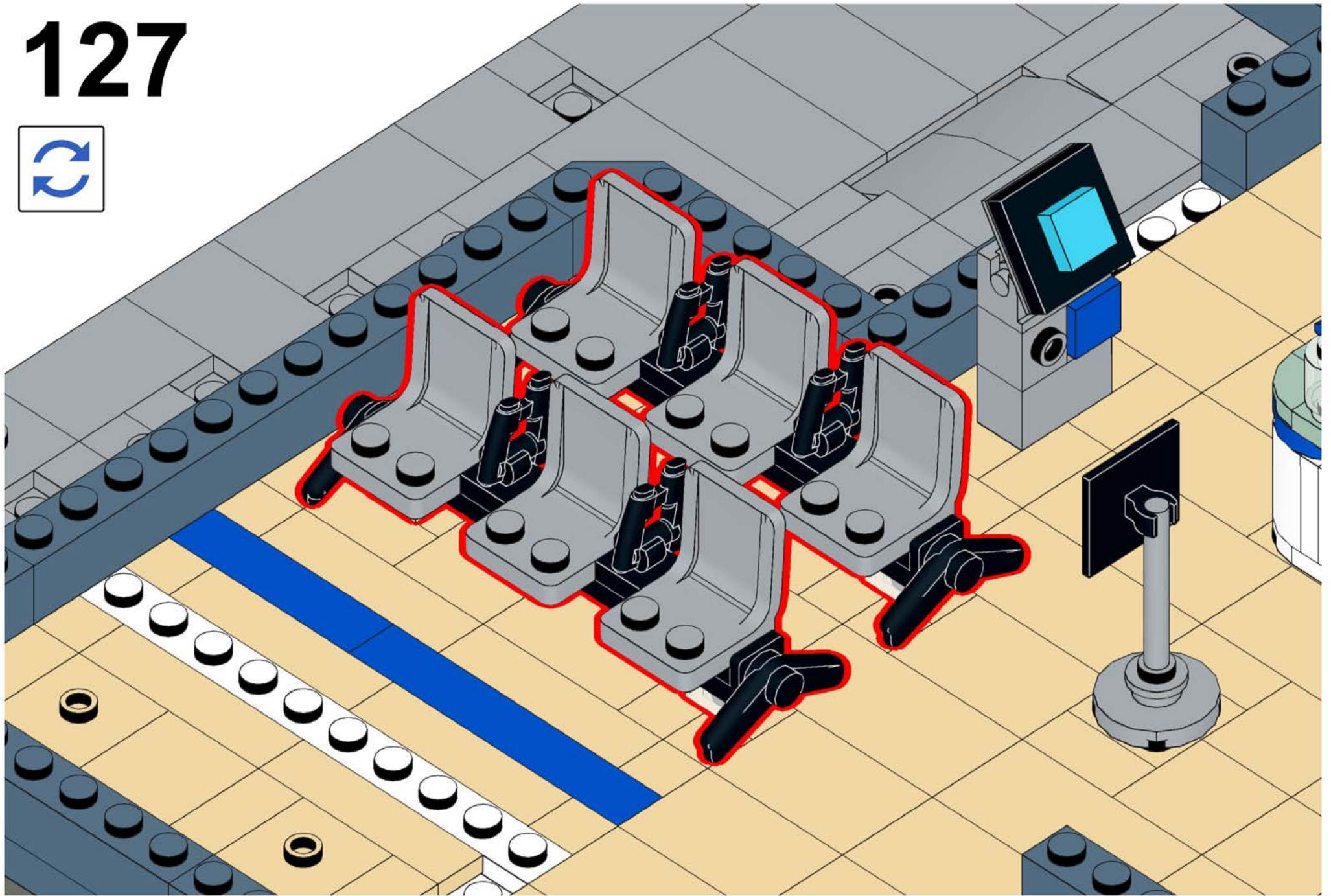

# 128

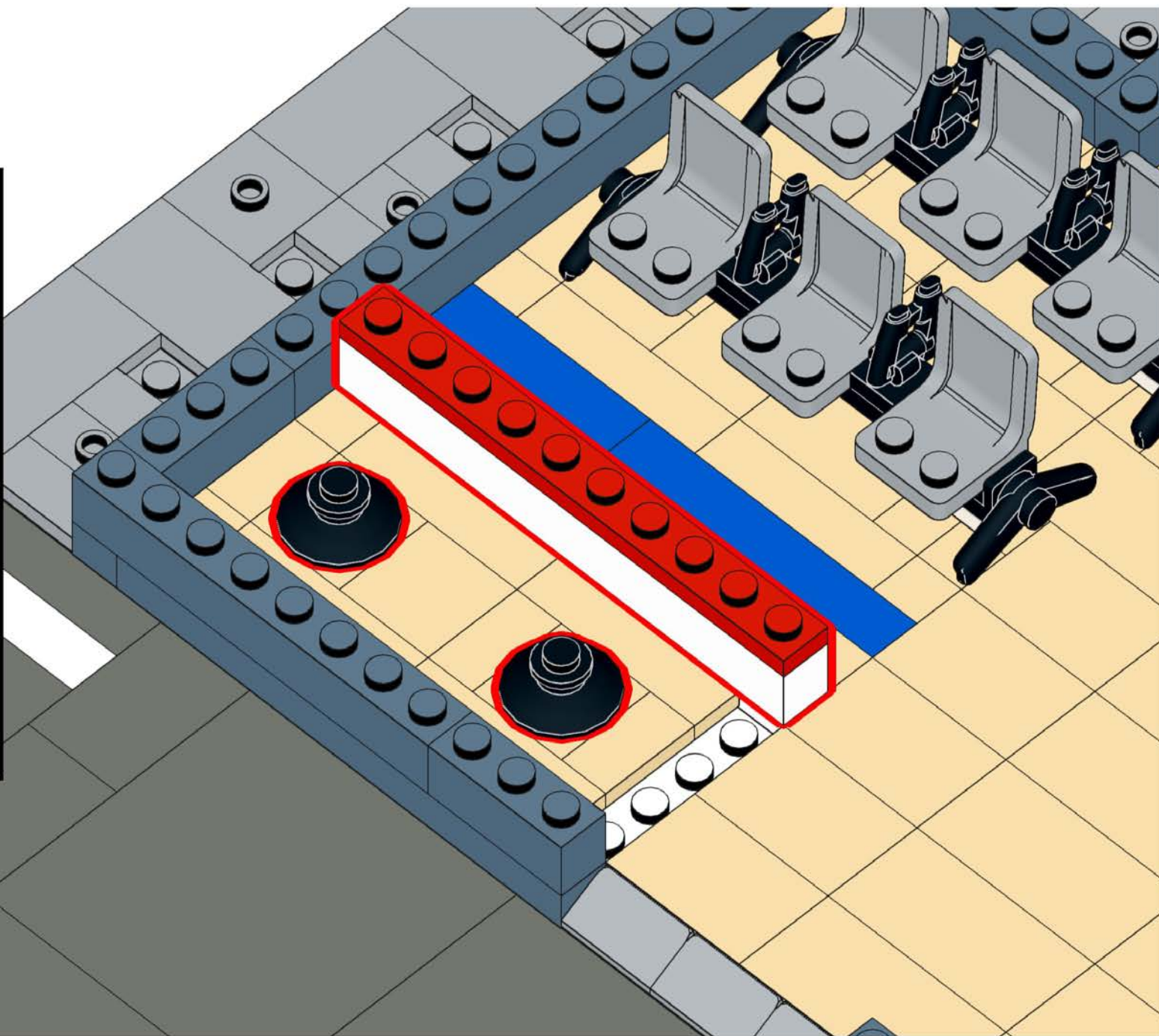
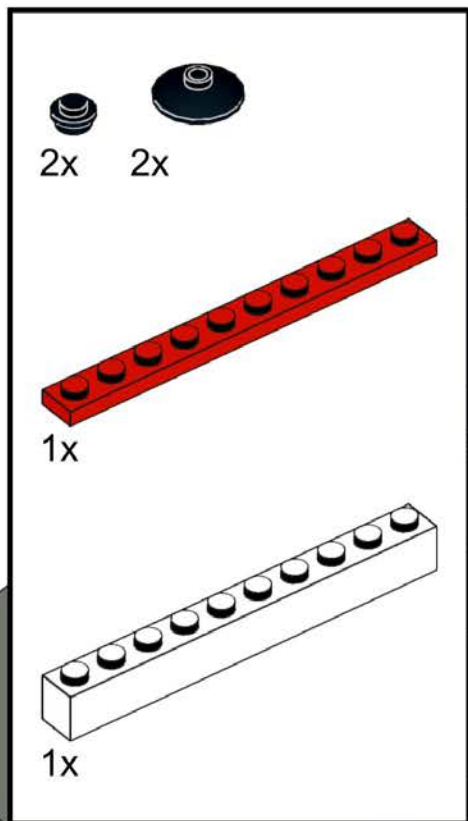

# 129

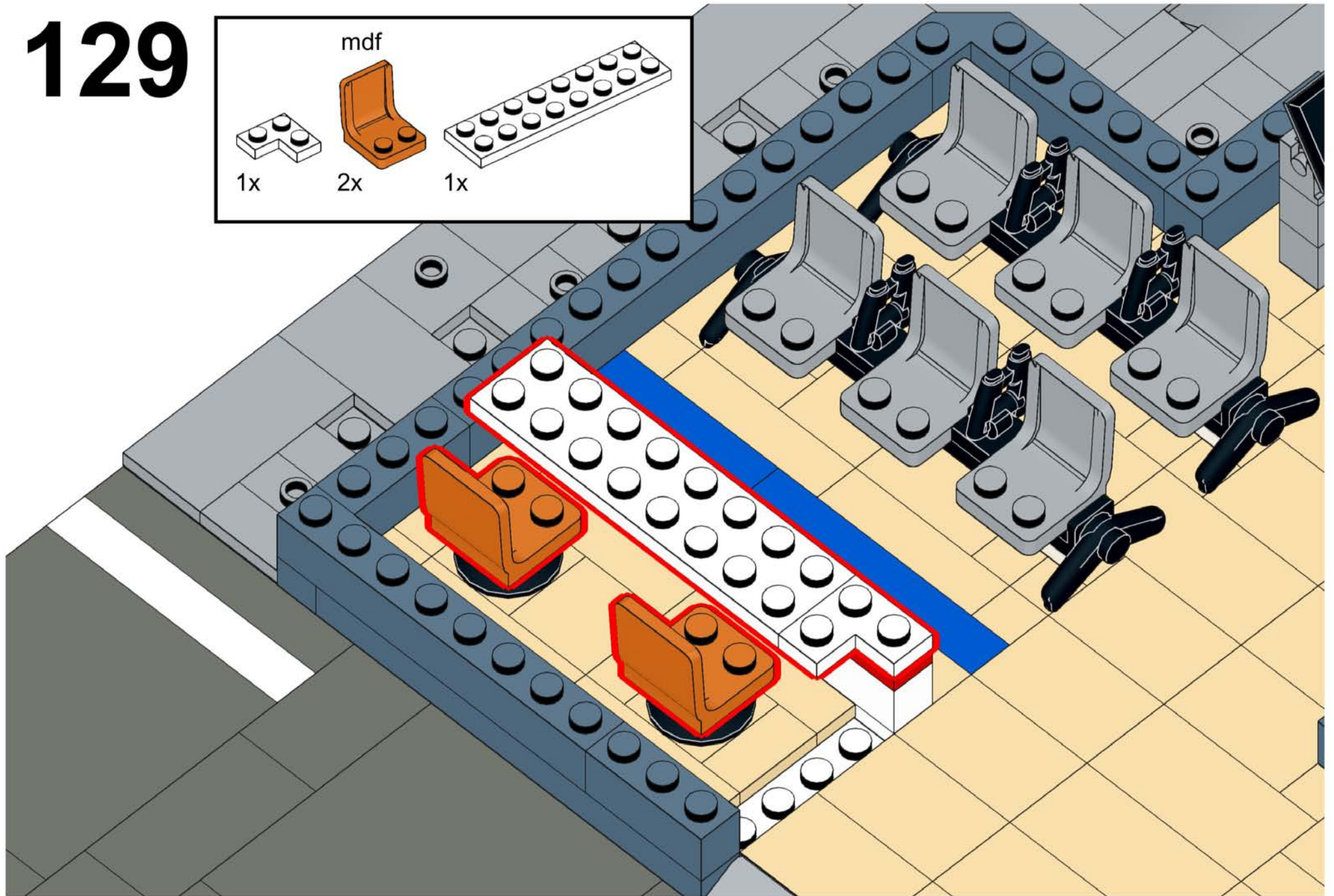
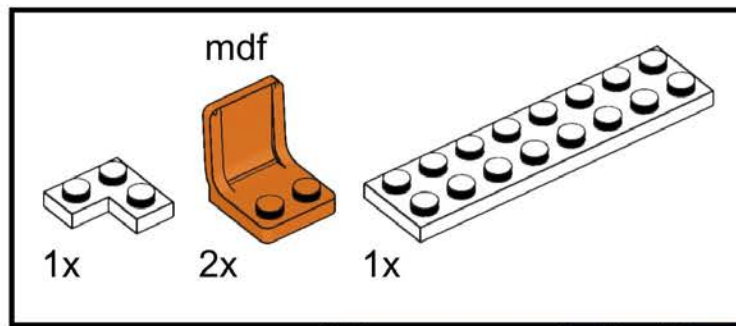

# 130

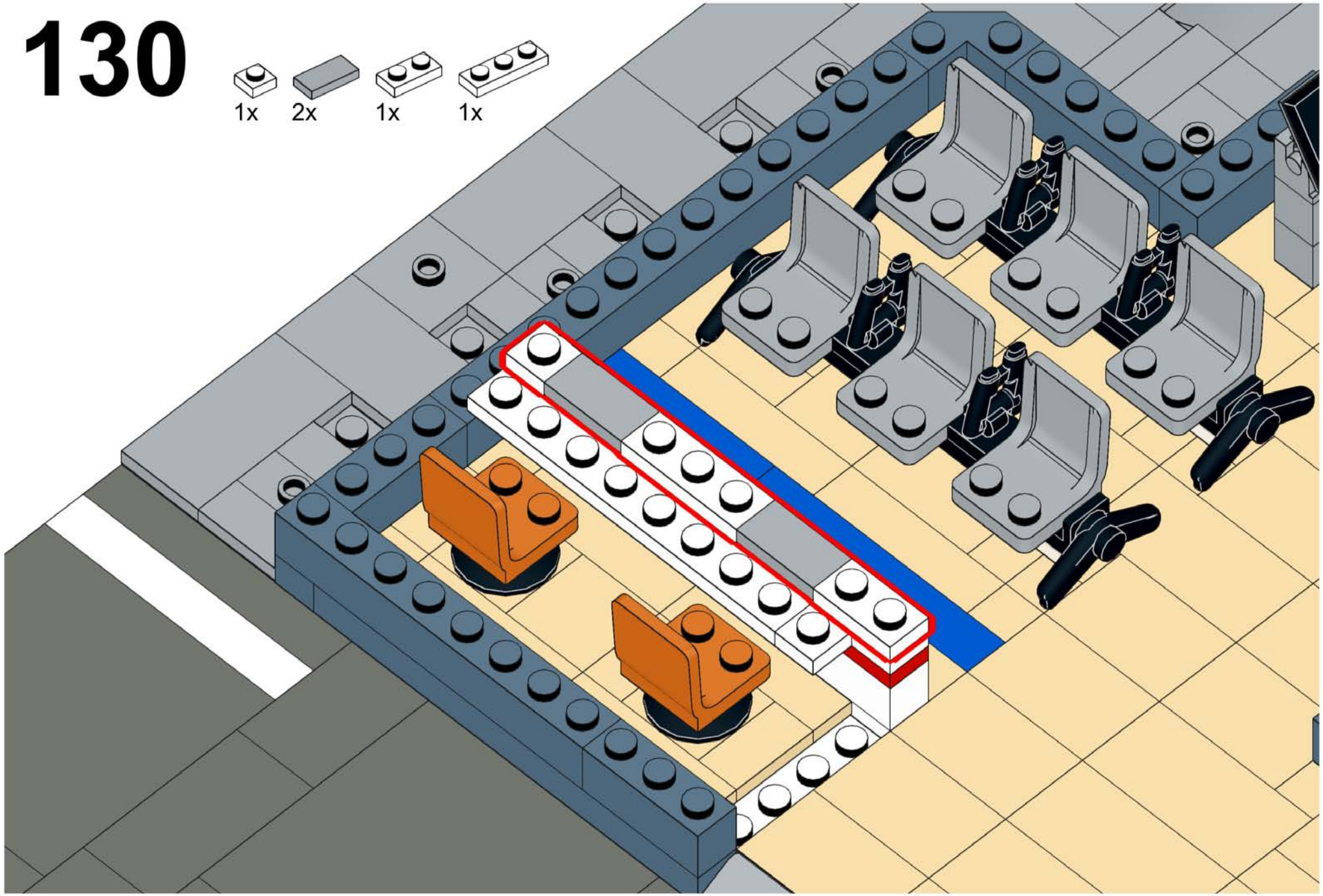
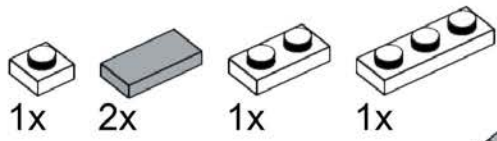

# 131

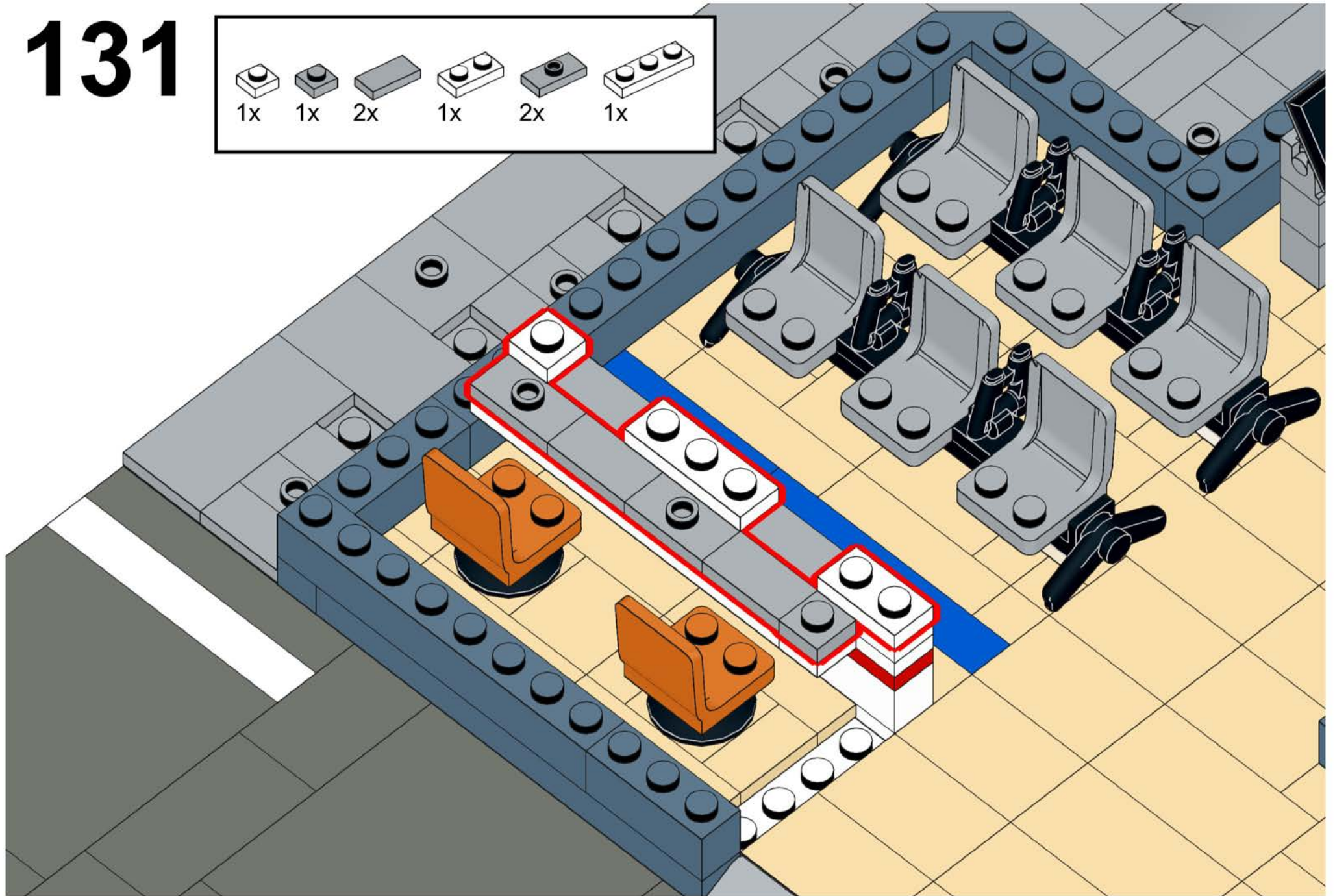
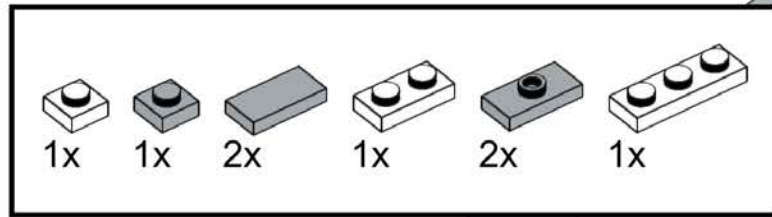

# 132

- 2x 
- 2x 
- 1x 
- 2x 
- 2x 

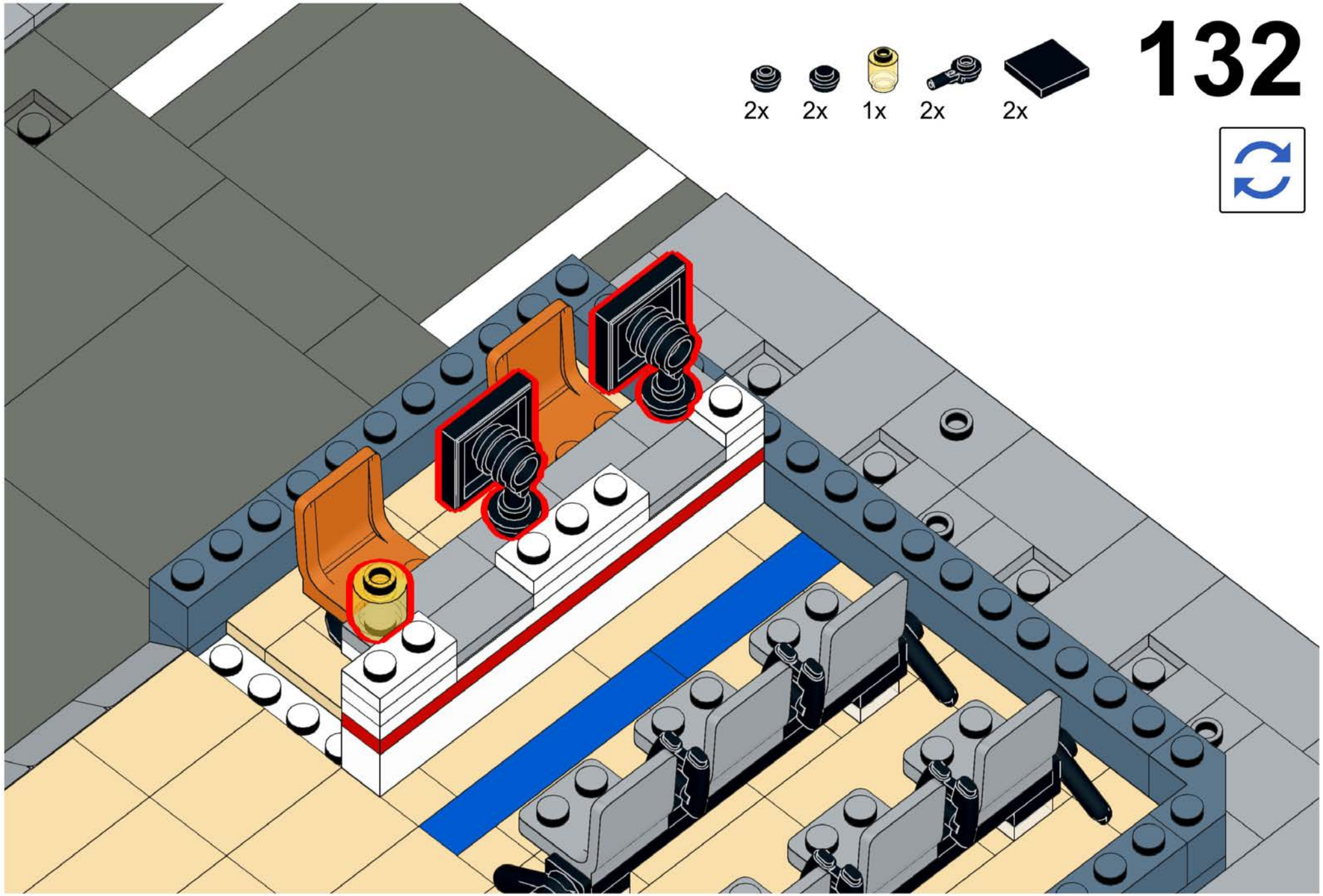



# 133

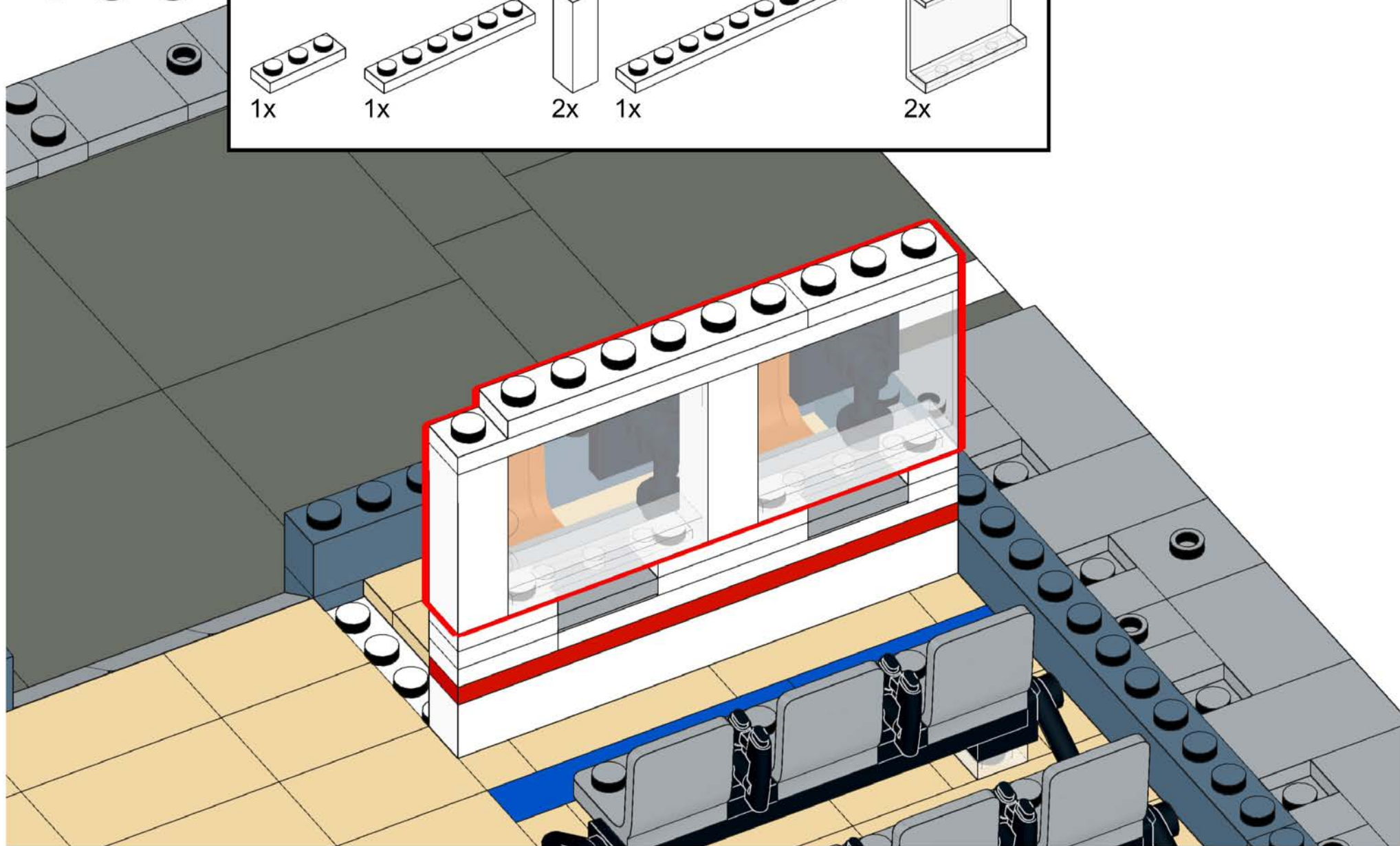
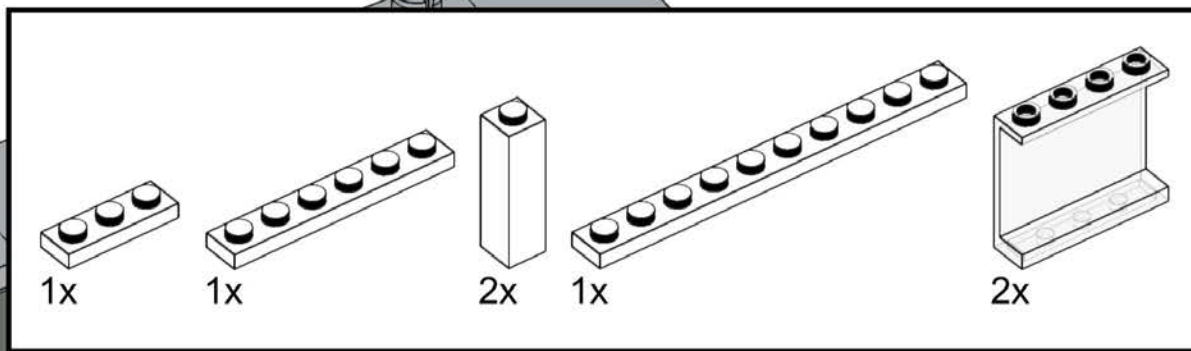

# 134

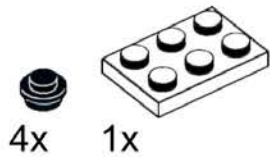

# 135

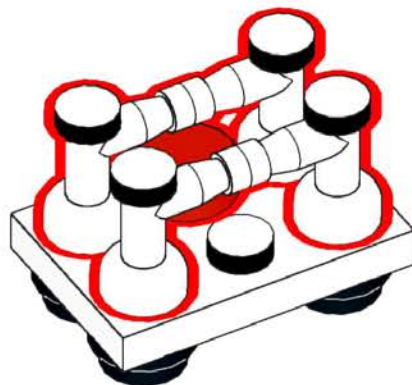
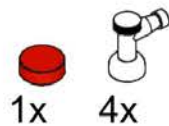

# 136



# 137

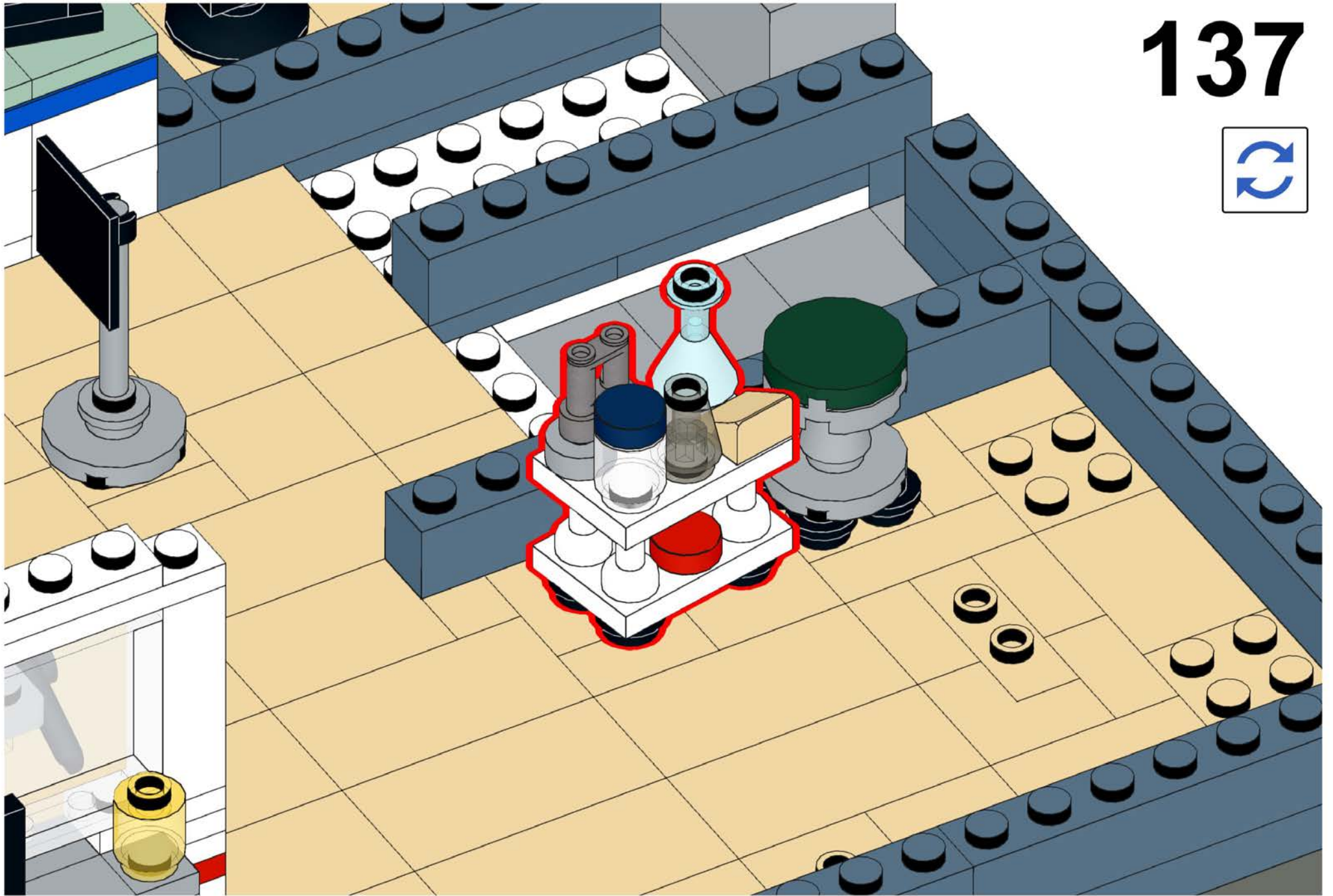

# 138

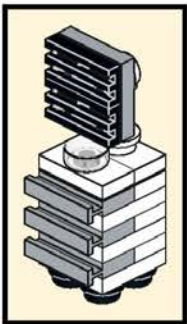
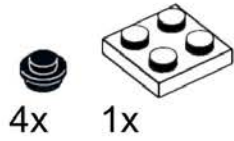

# 139

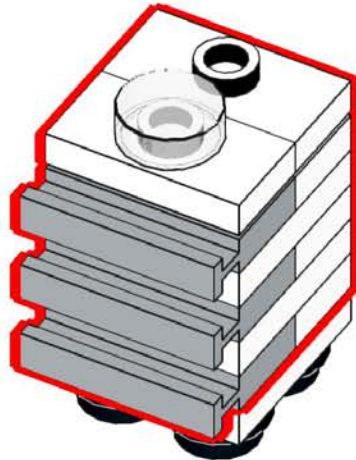
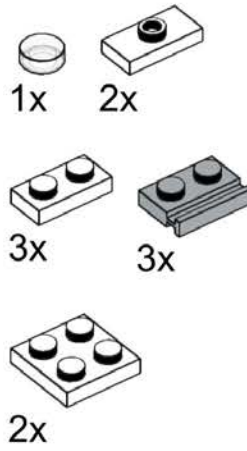

# 140

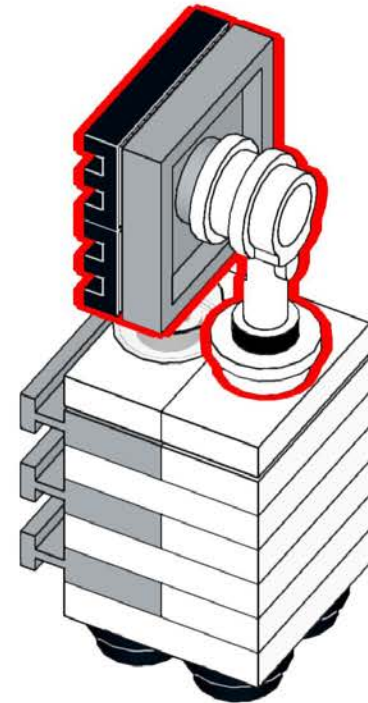
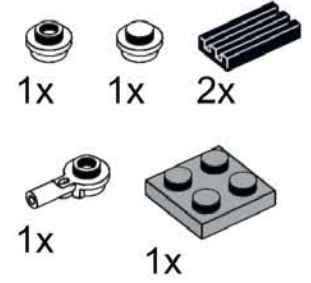

141

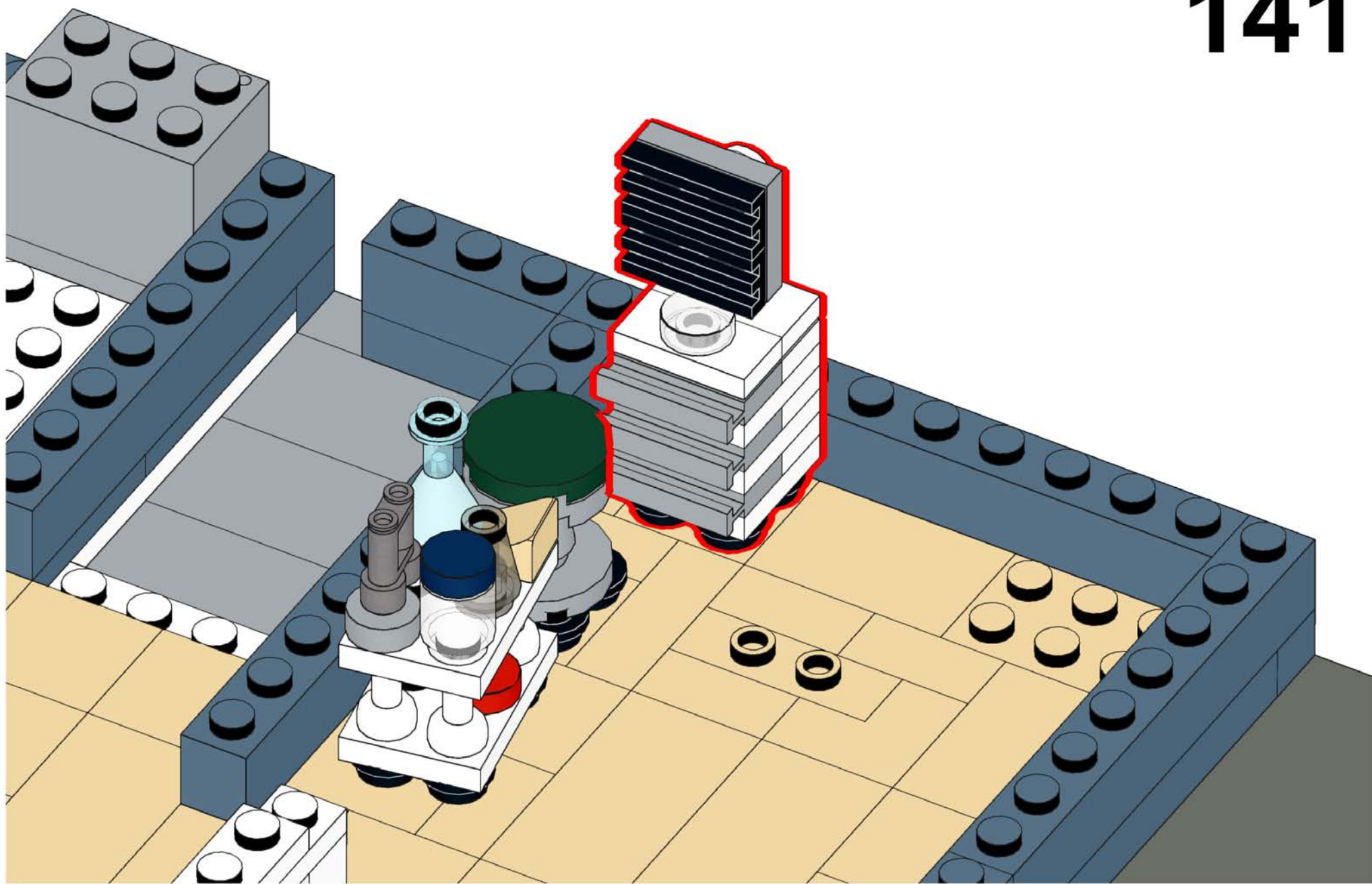

# 142

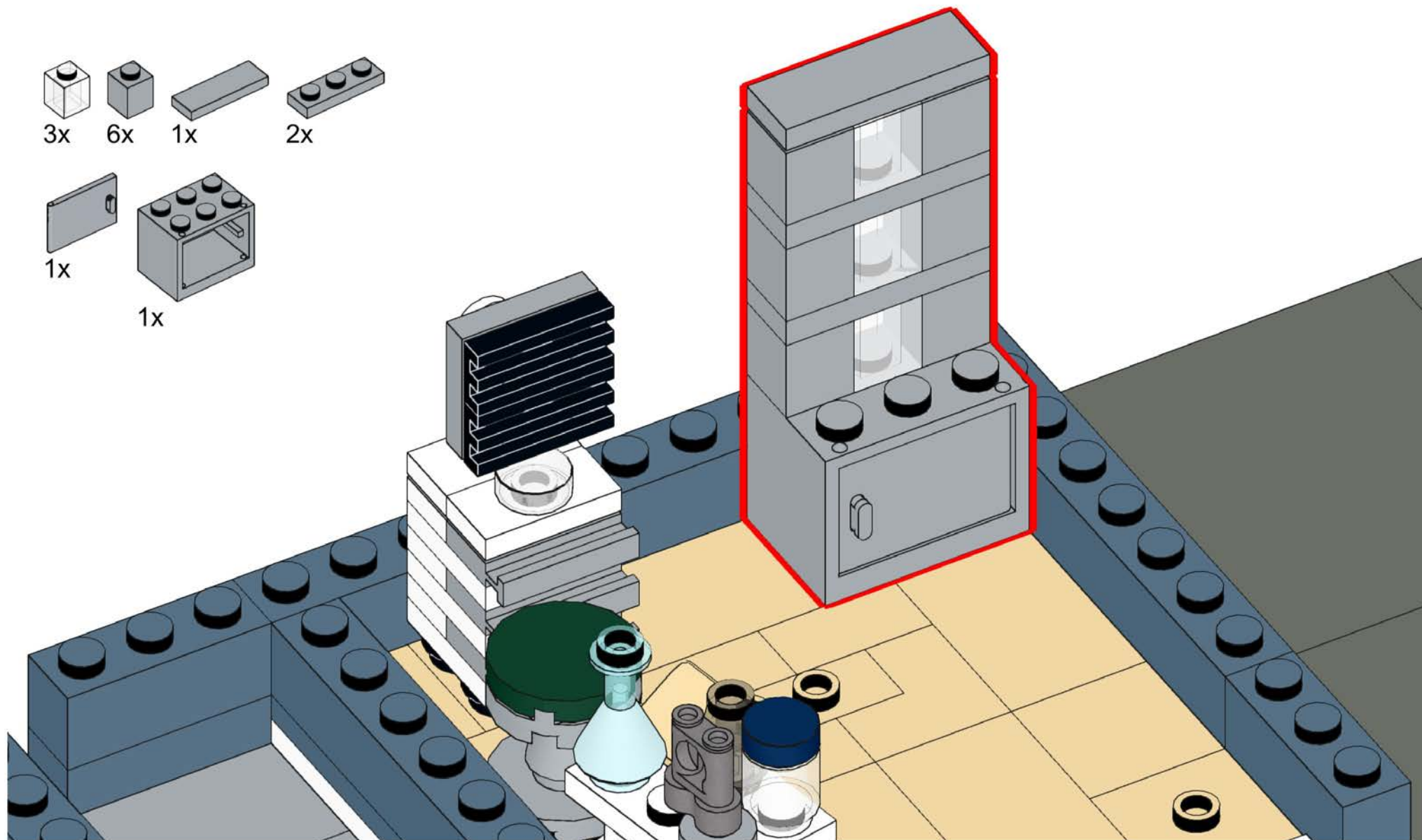
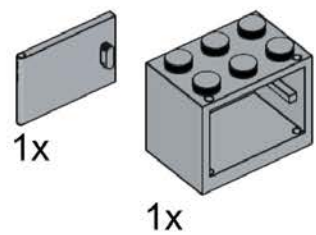
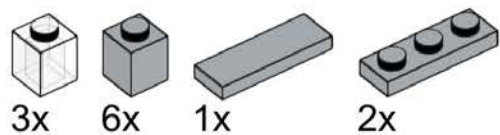

# 143

- 1x 
- 1x 
- 3x 
- 1x 
- 1x 
- 1x 

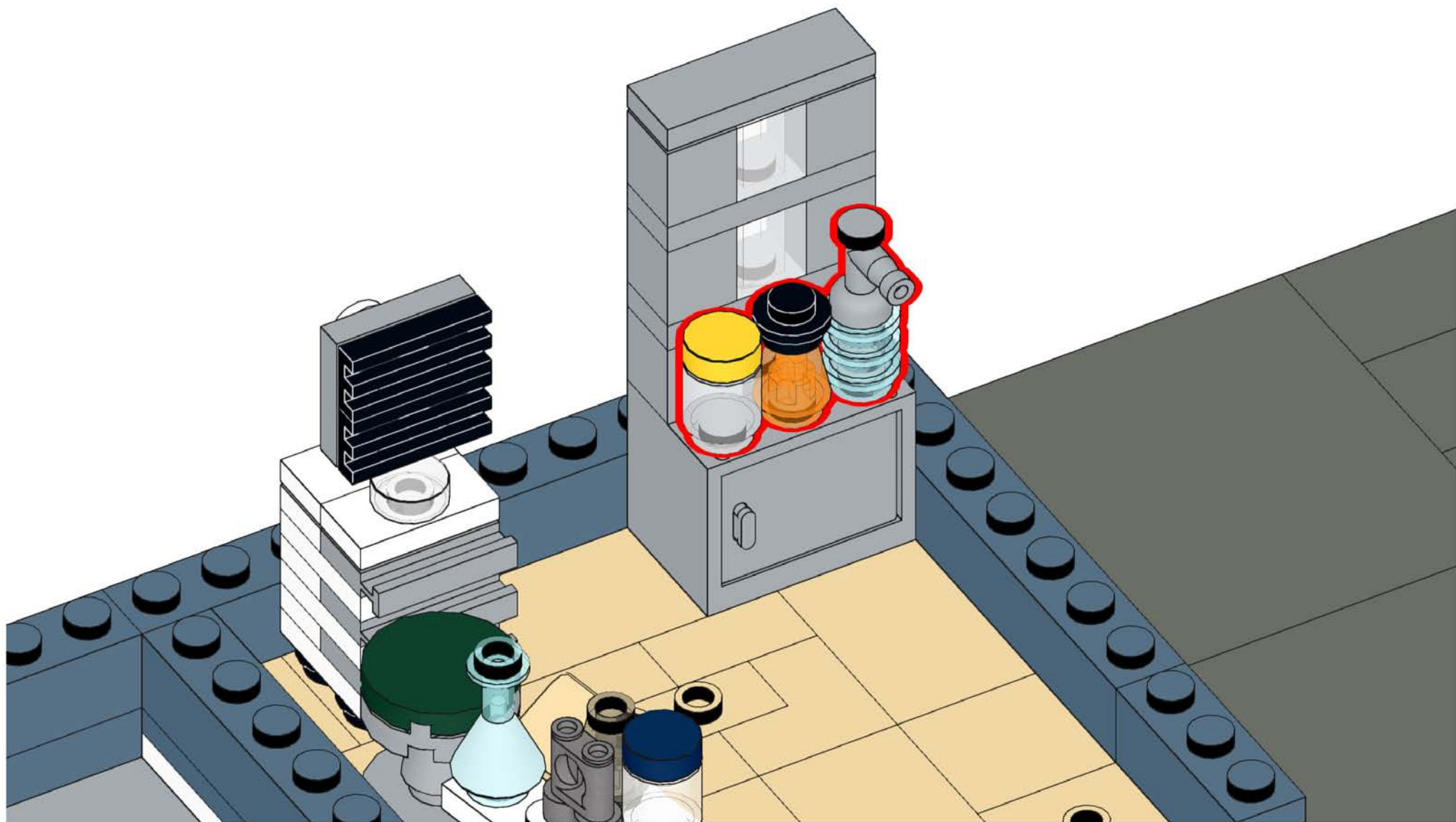

# 144

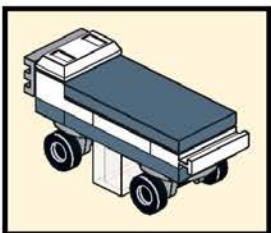
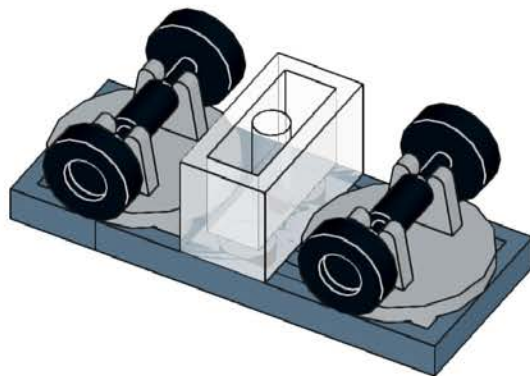
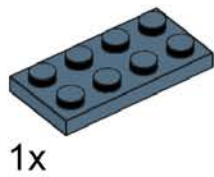
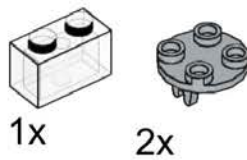
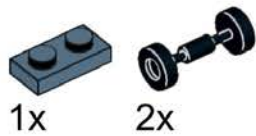

# 145

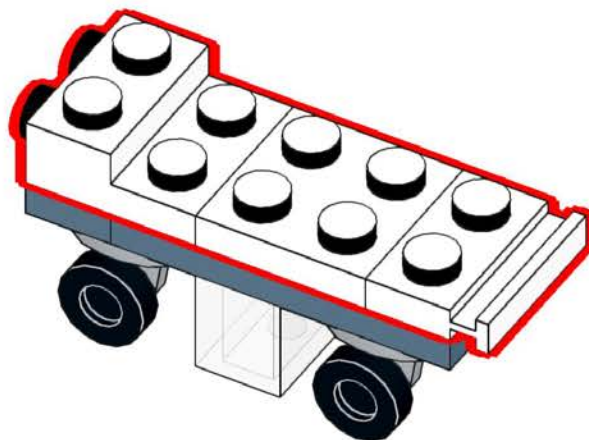
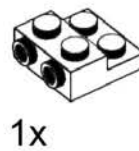
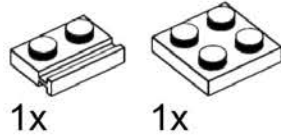

# 146

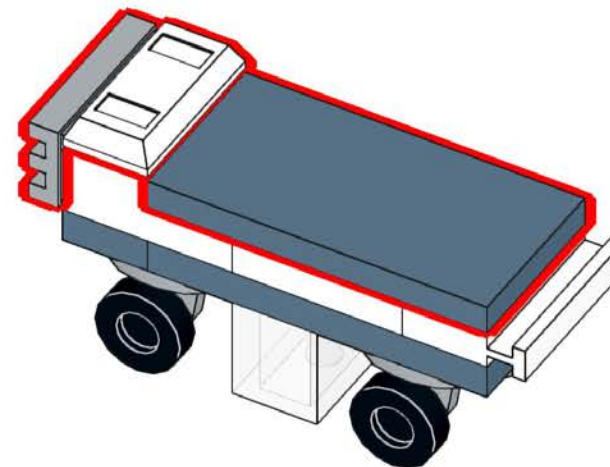
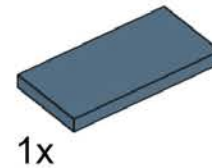
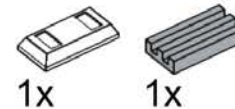



# 147

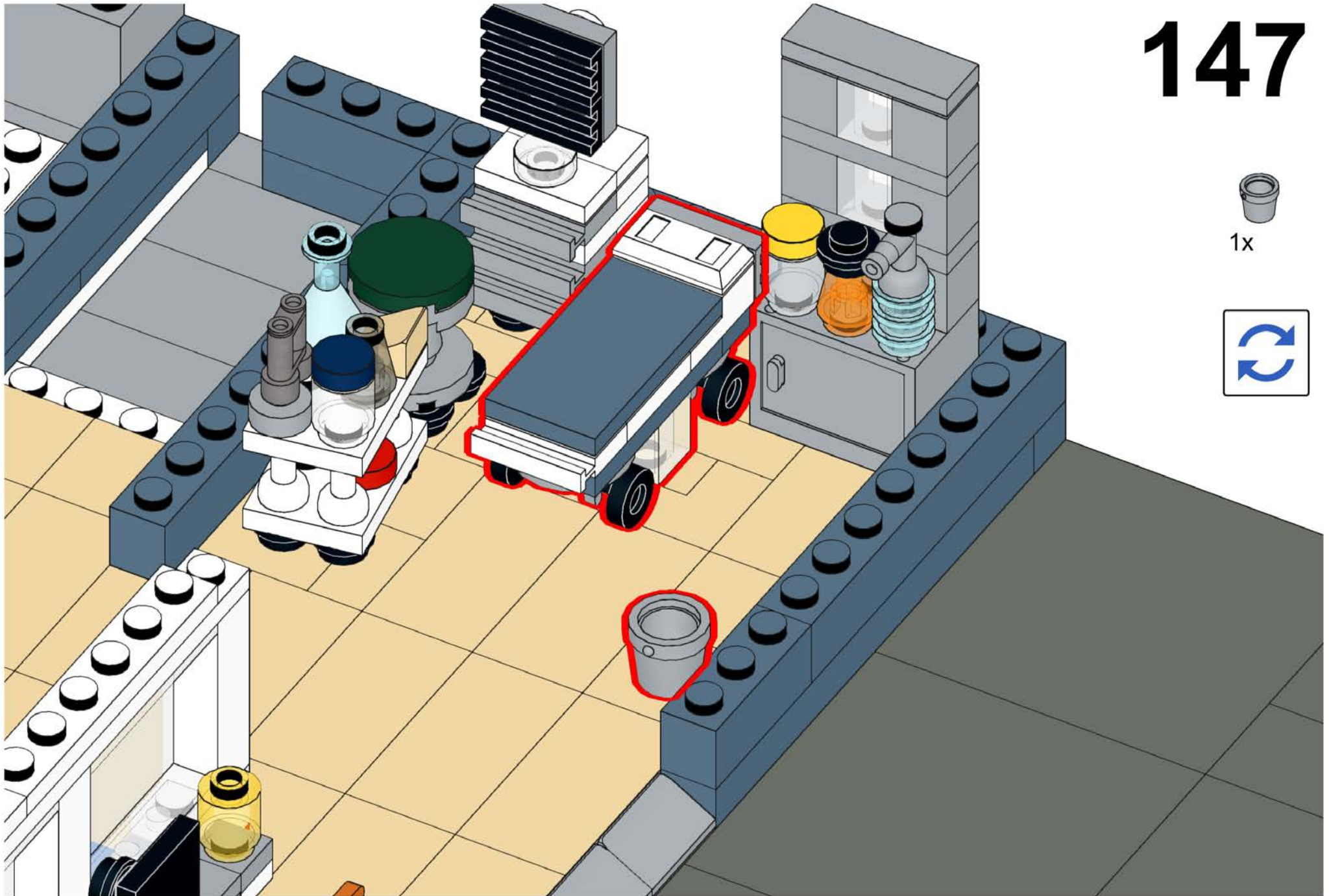

1x



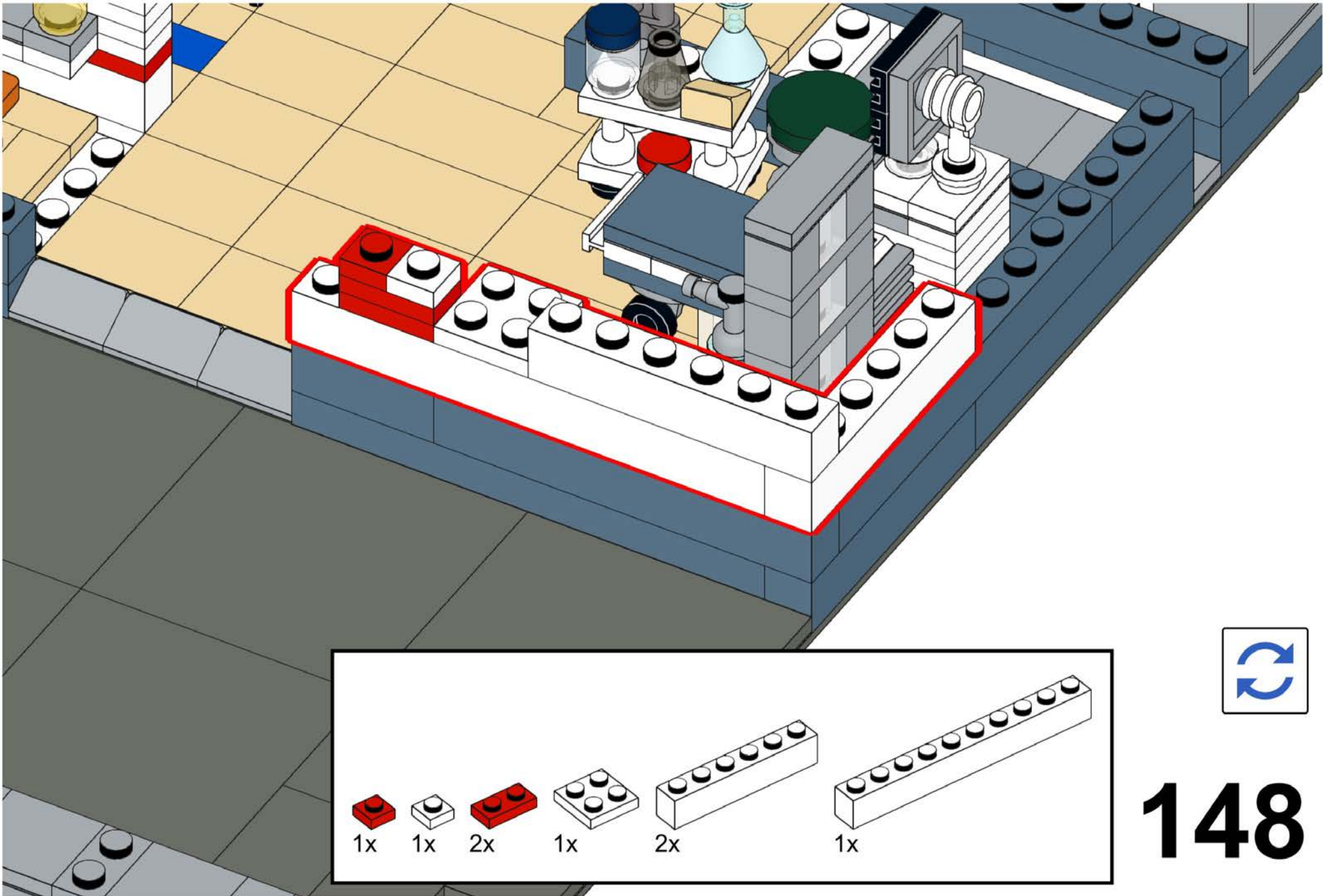

148

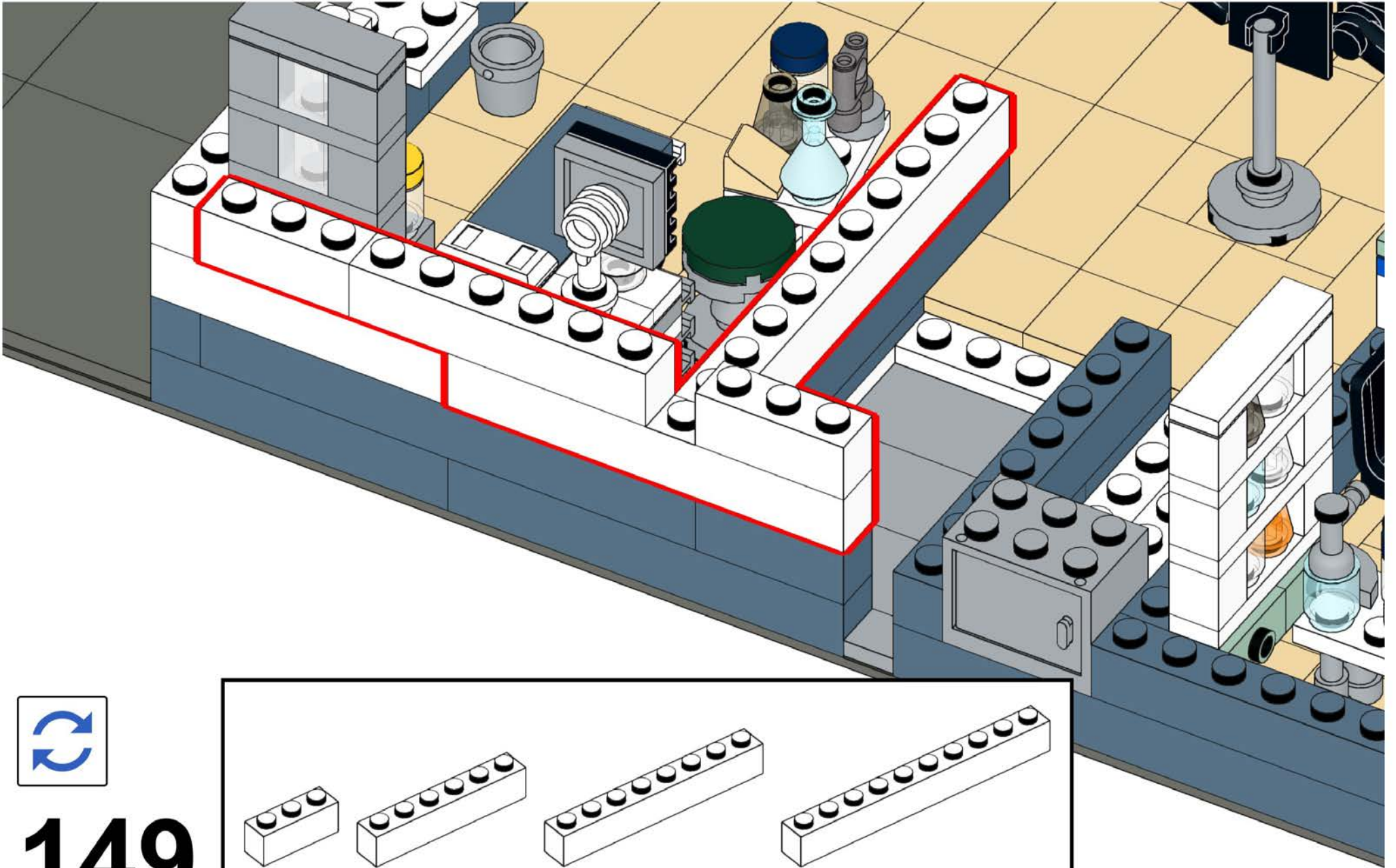

149

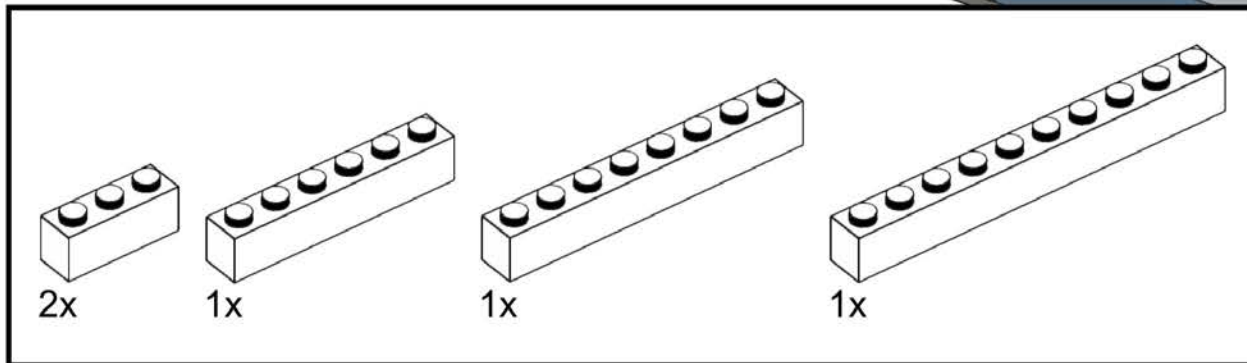



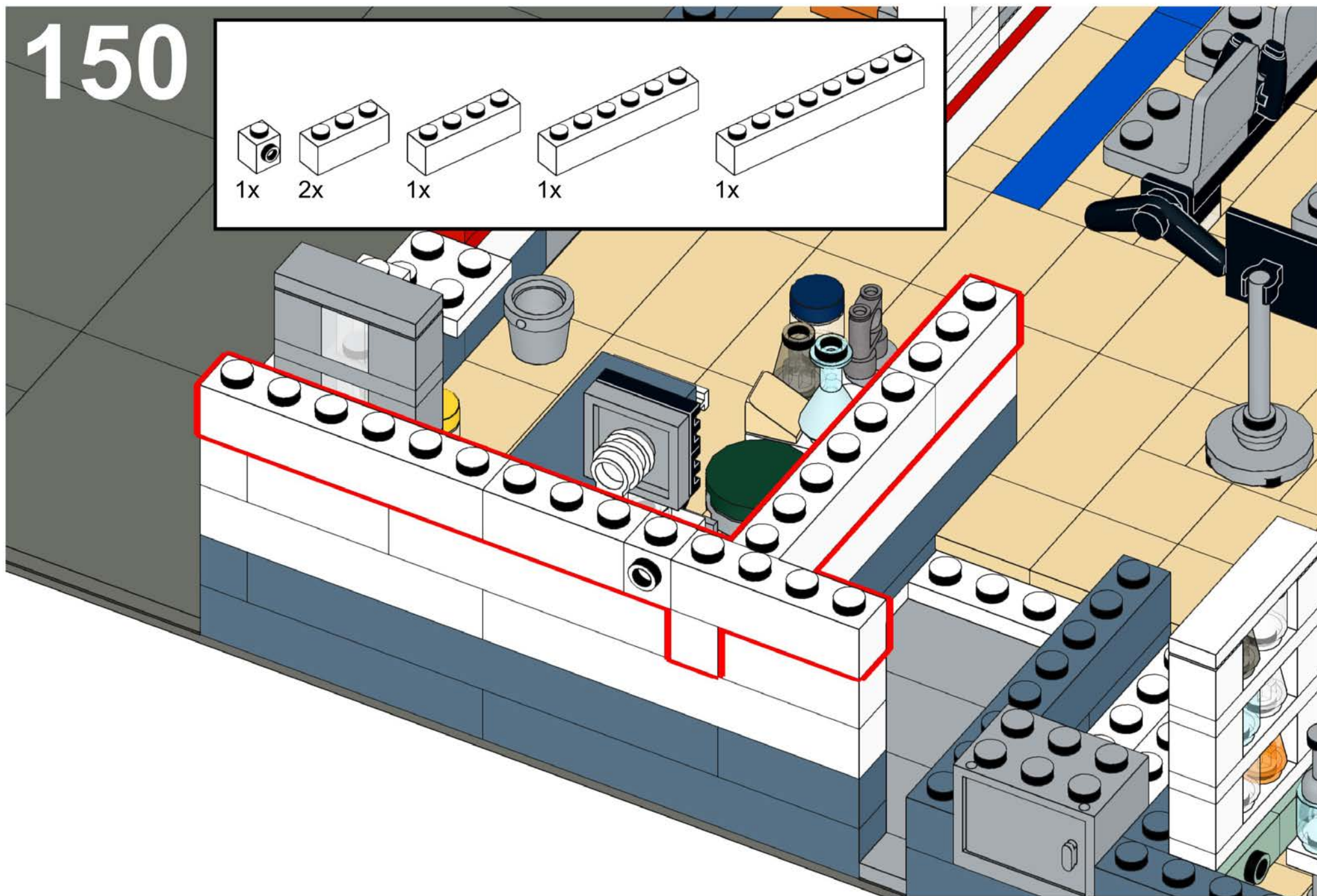
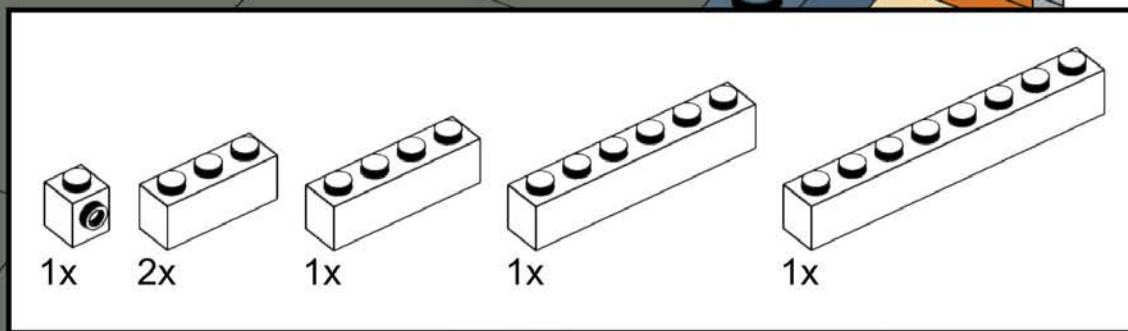



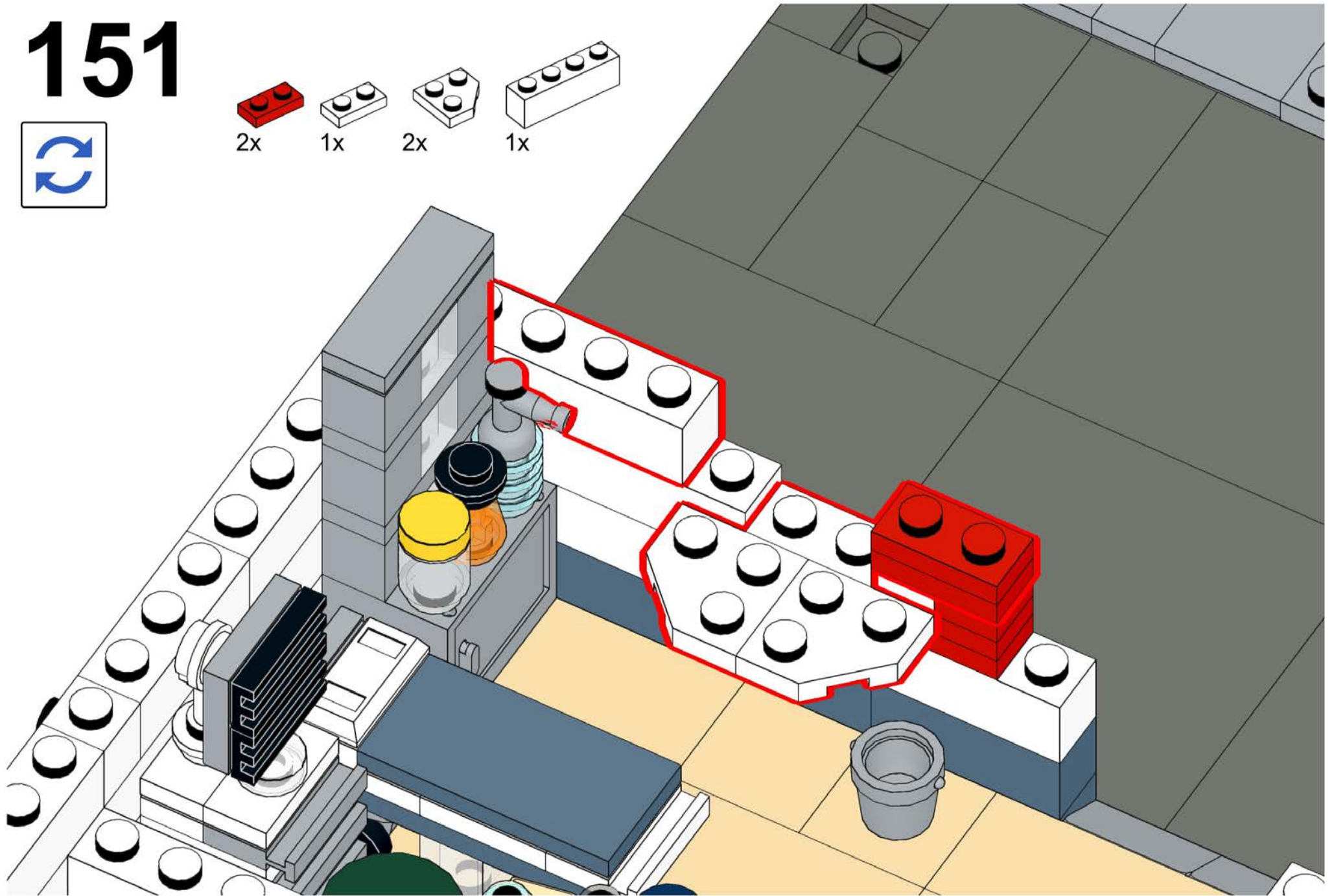
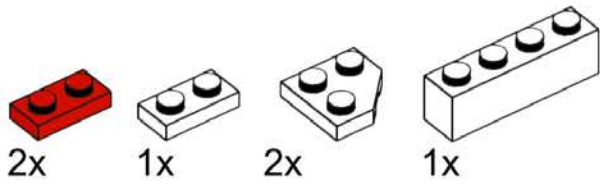

# 150



# 151



# 152

							
1x	1x	1x	1x	1x	1x	1x	1x

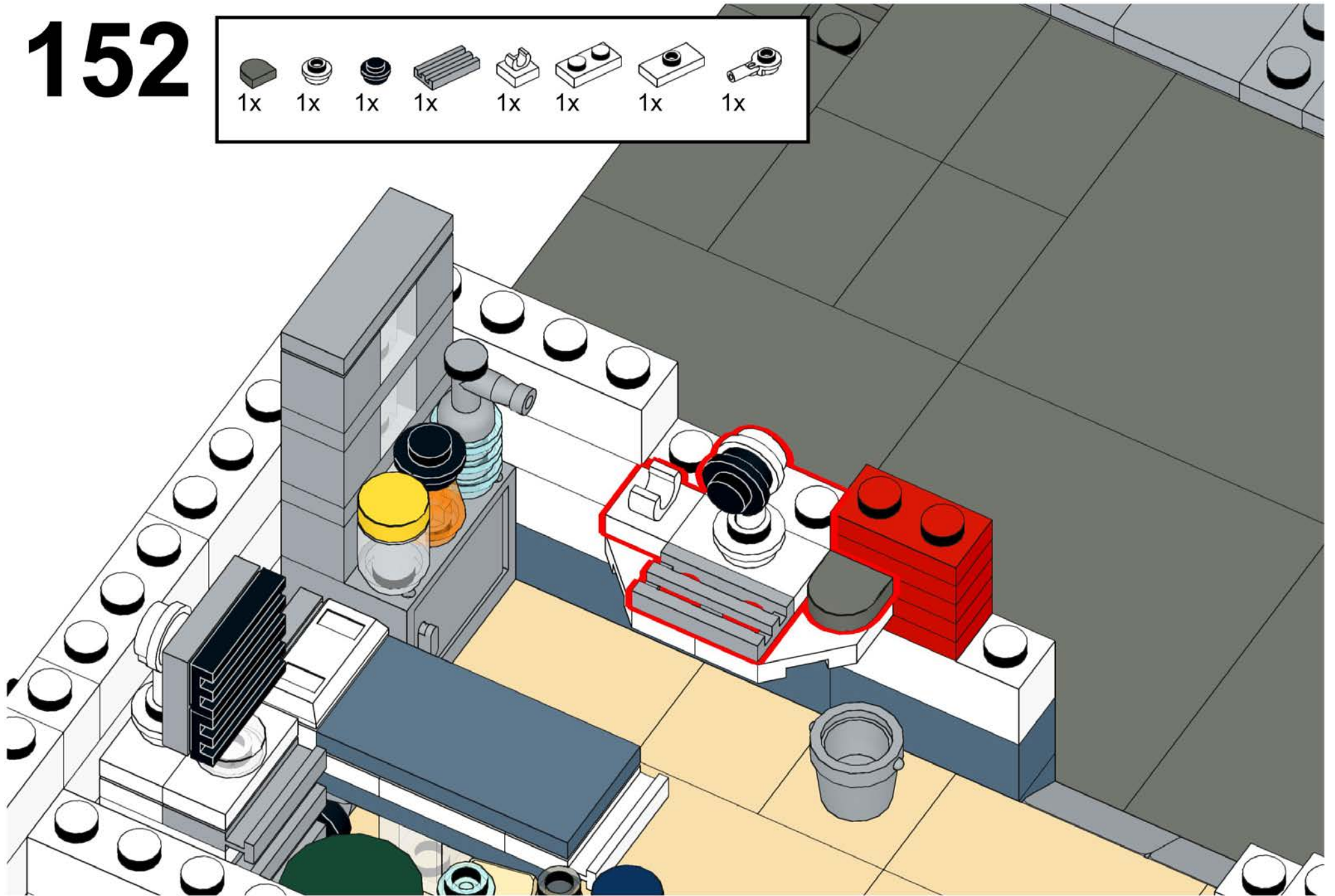

# 153

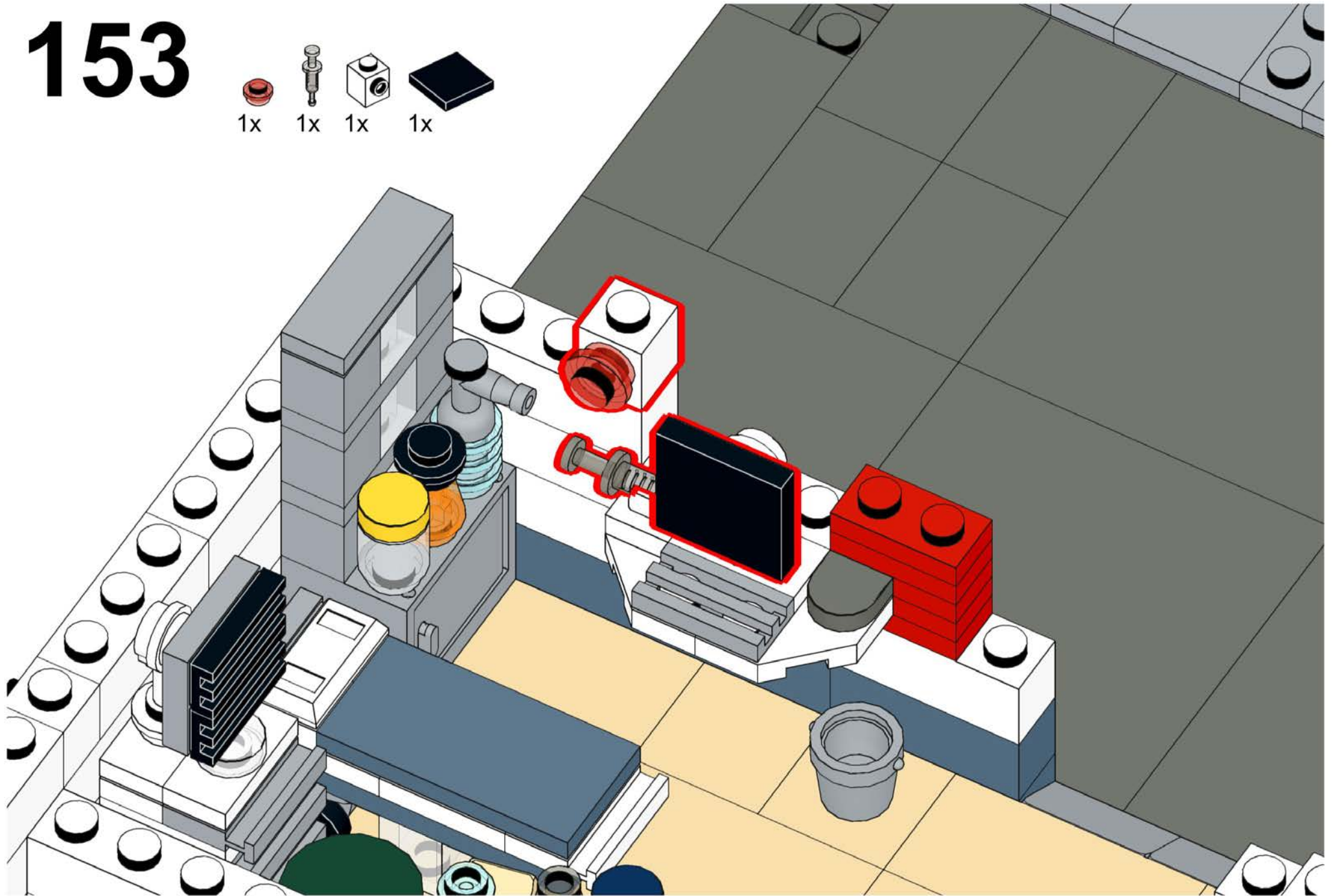
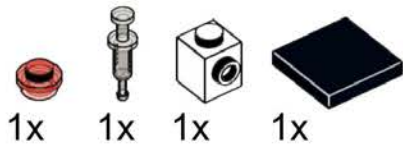

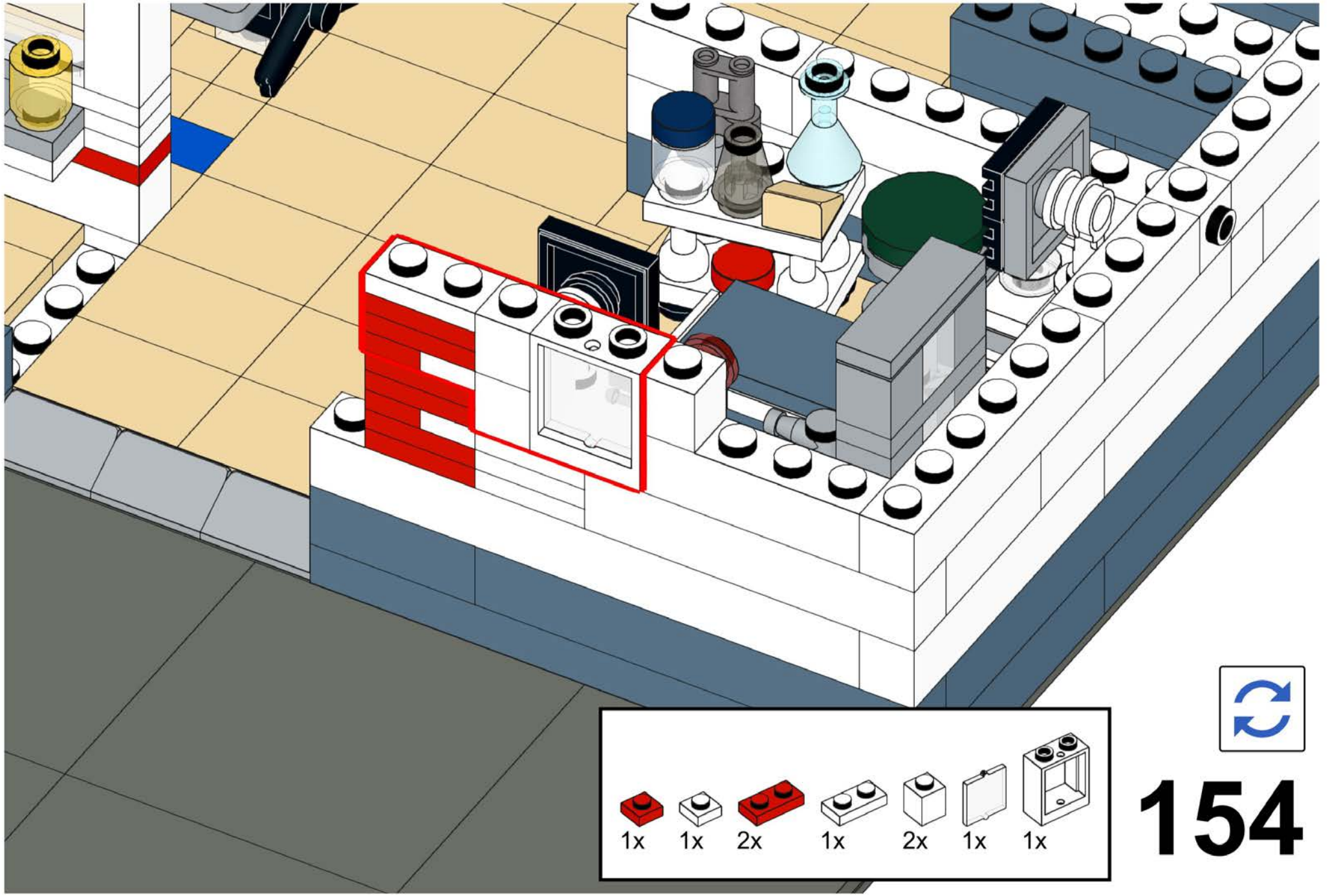



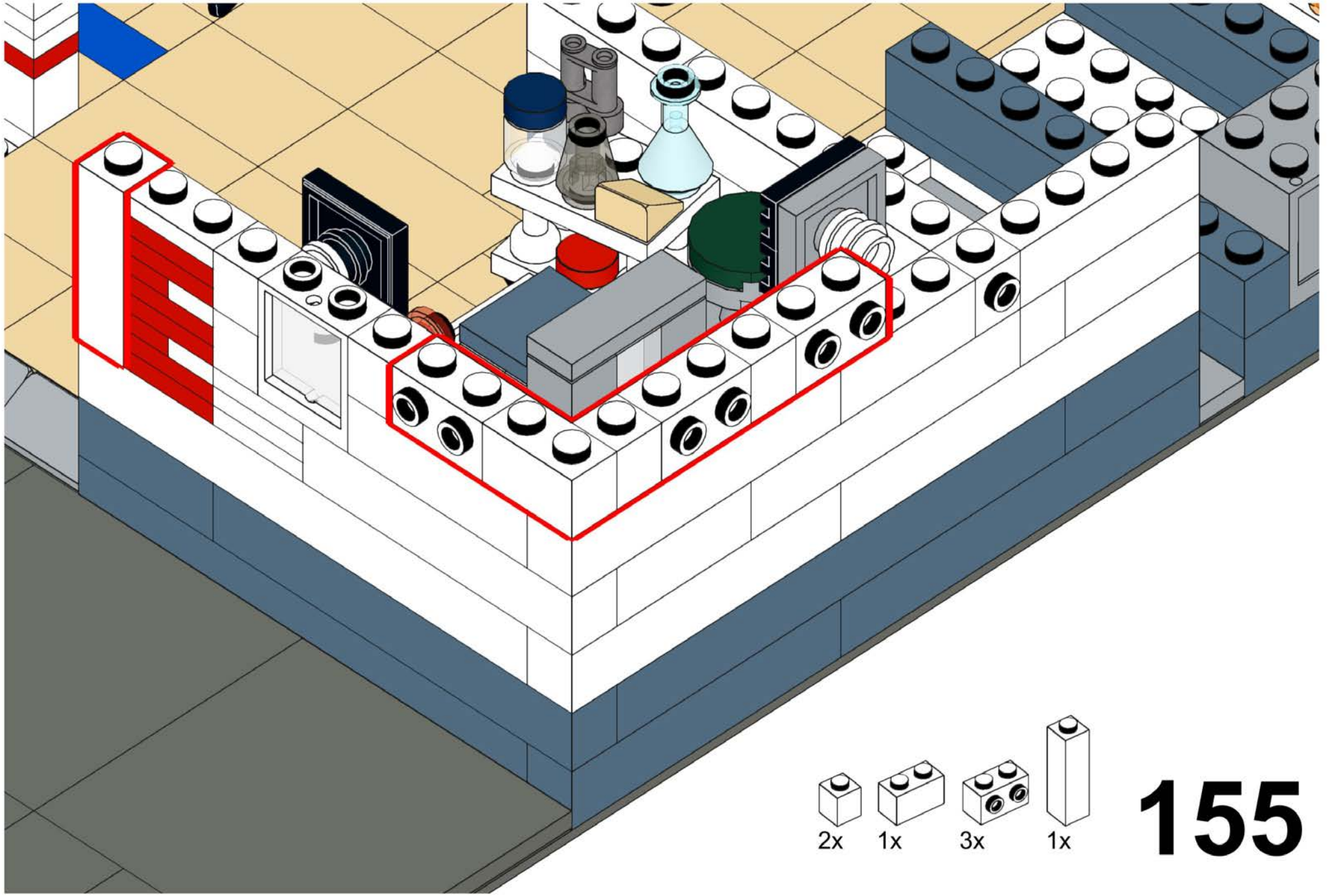

2x

1x

3x

1x

**155**

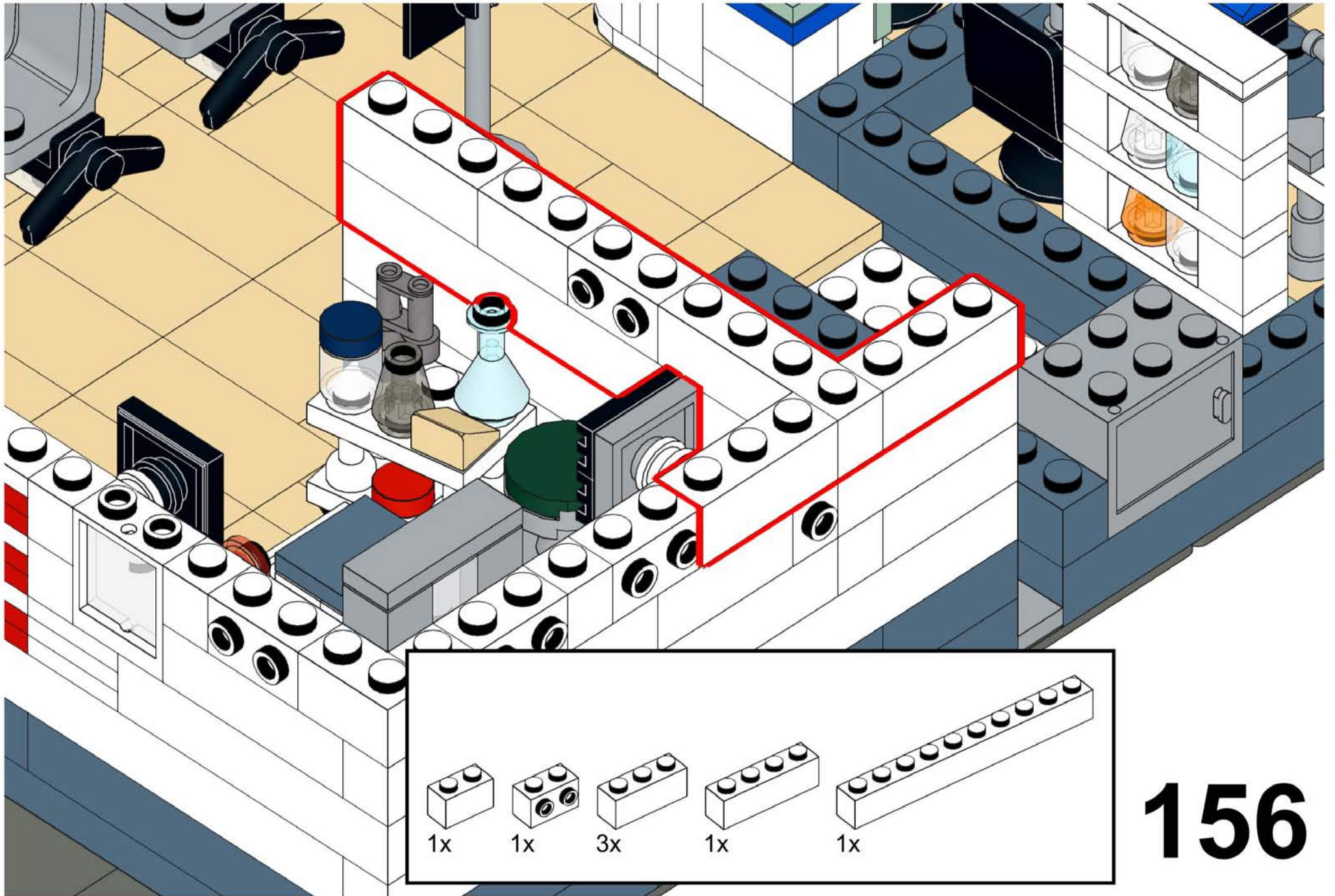

156



# 157

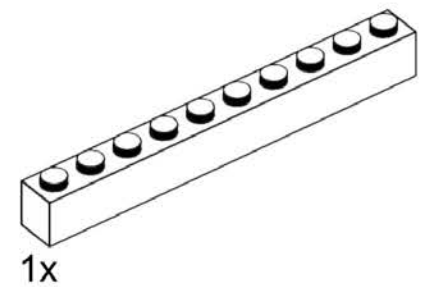
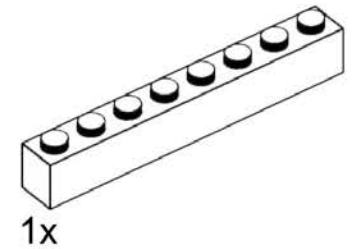
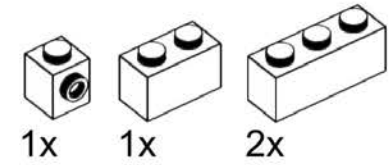
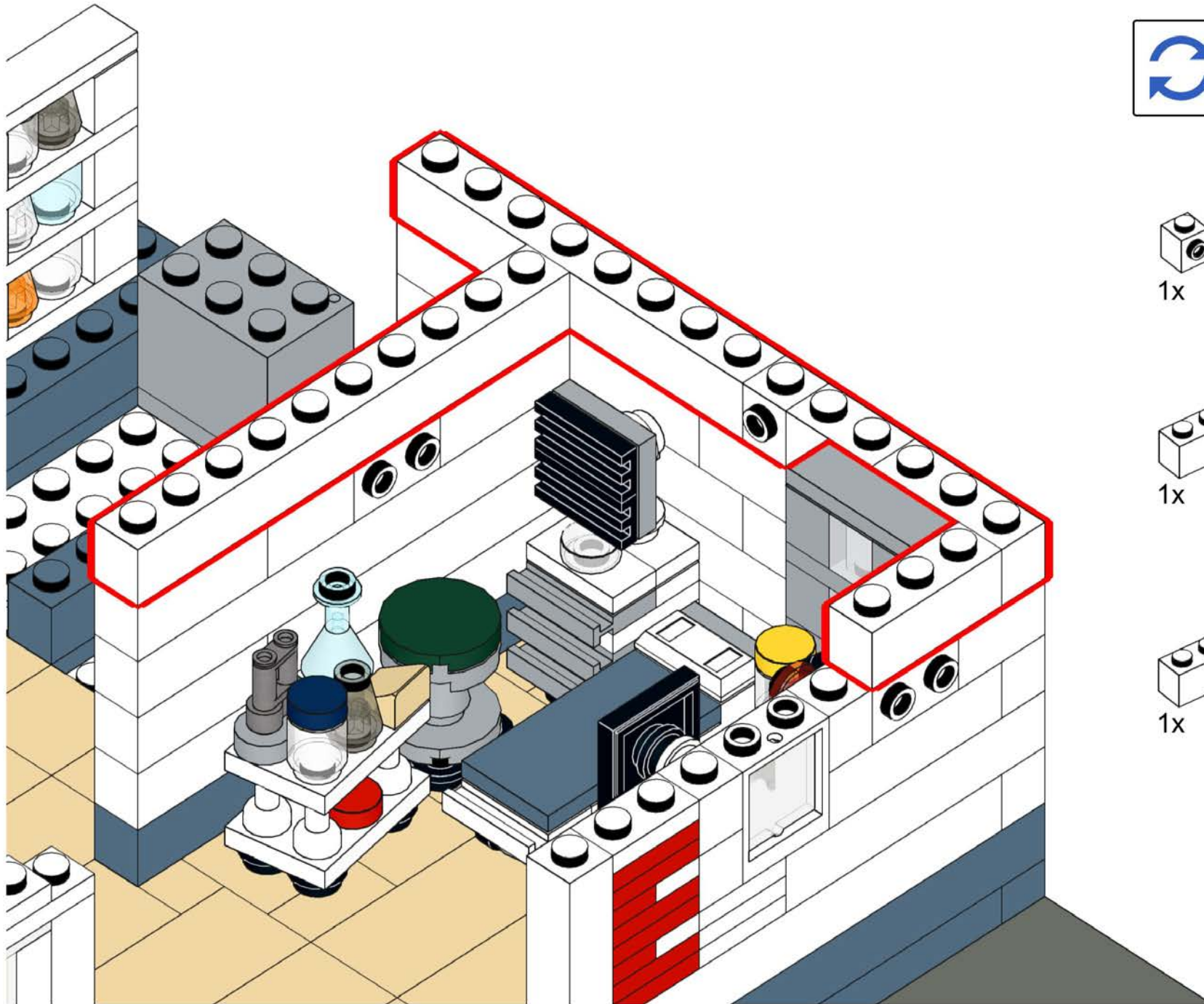

# 158

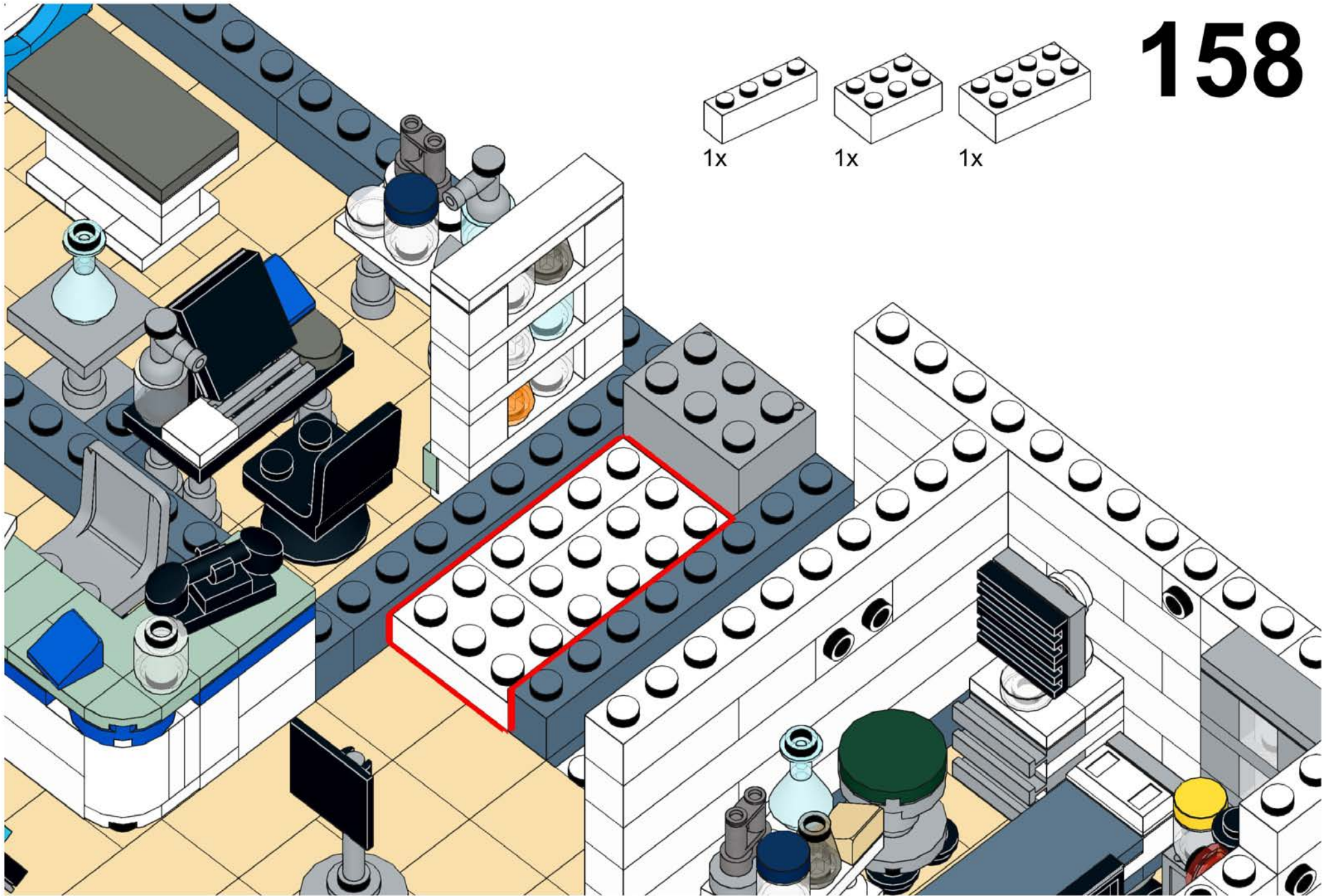

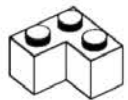
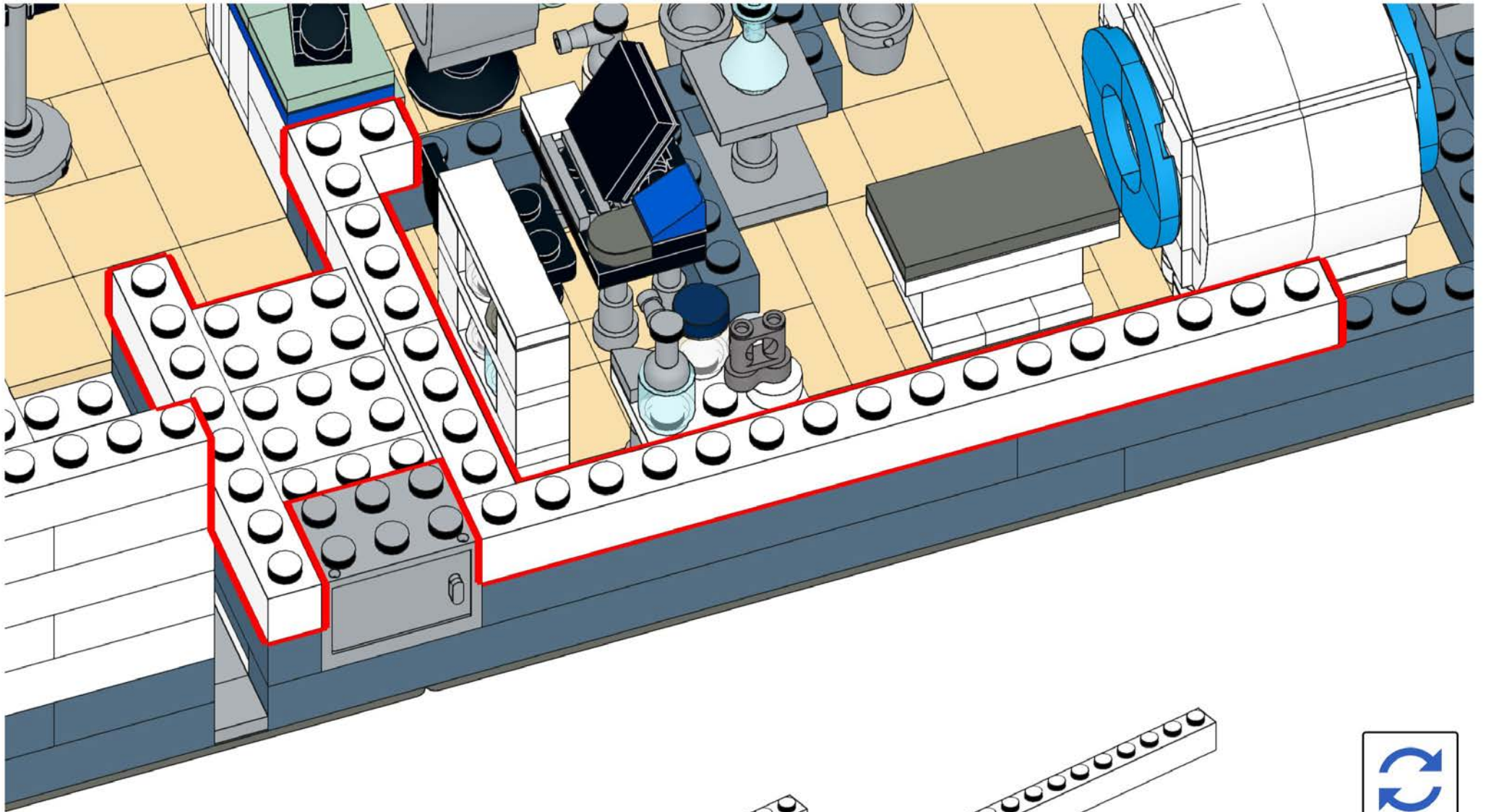

1x

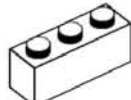

2x

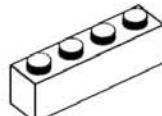

1x

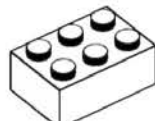

2x

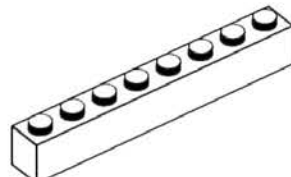

1x

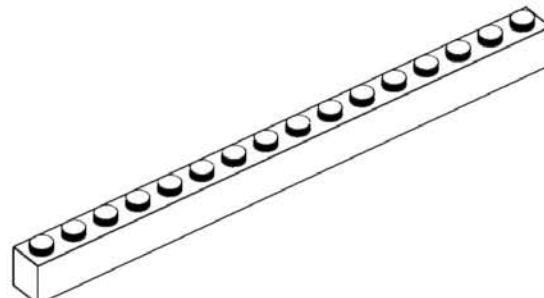

1x



# 159

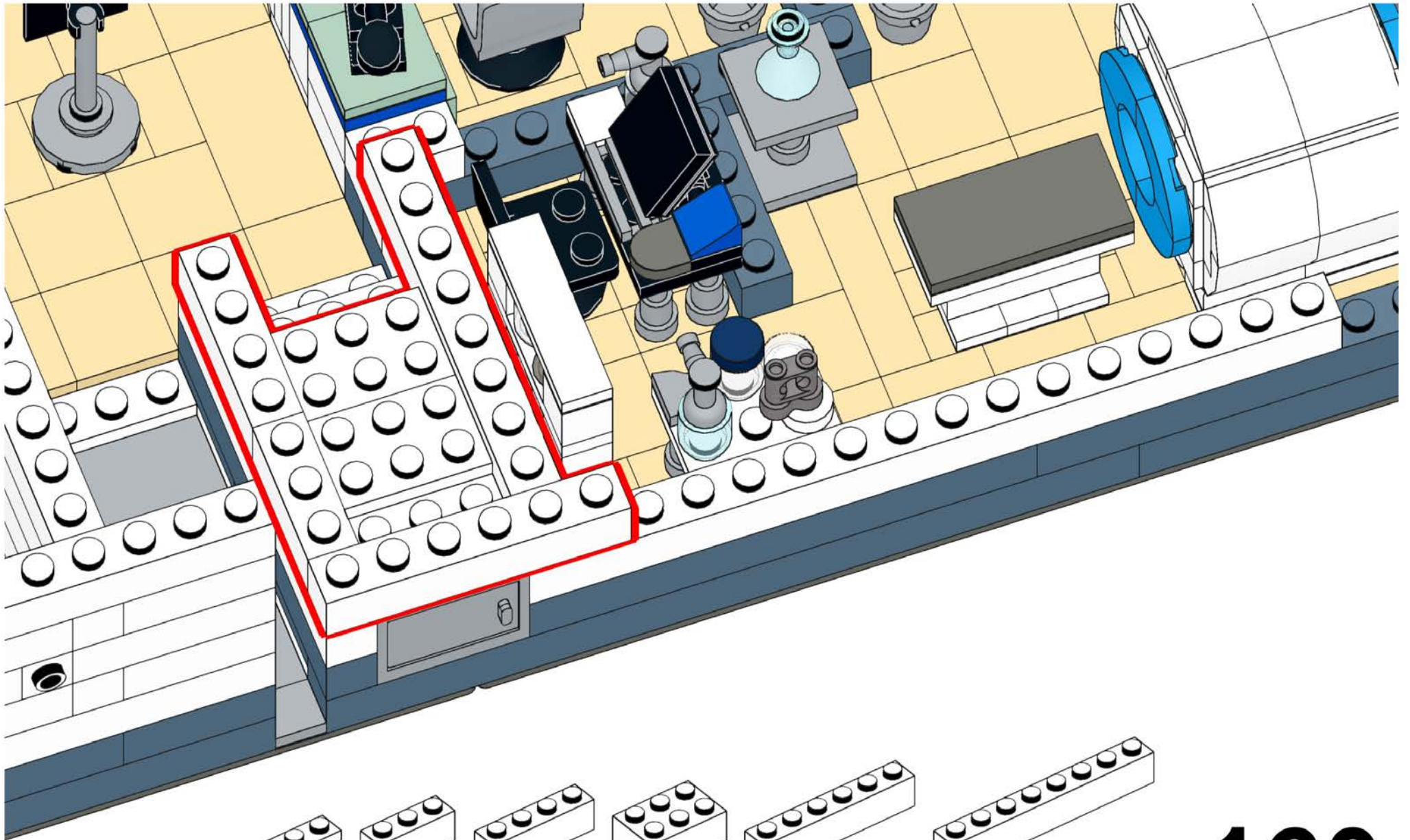

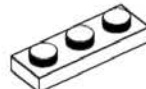
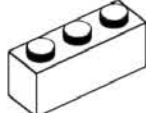
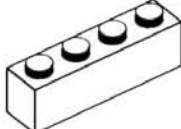
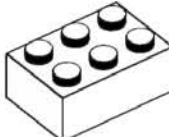
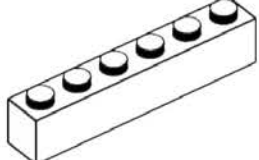
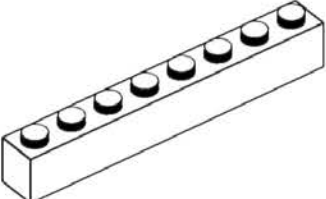
- 1x 
- 1x 
- 1x 
- 2x 
- 1x 
- 1x 

**160**

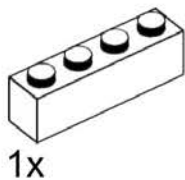
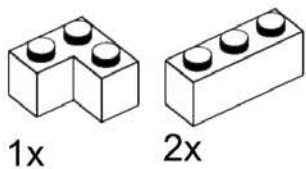
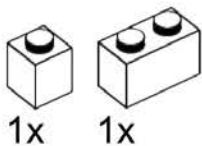
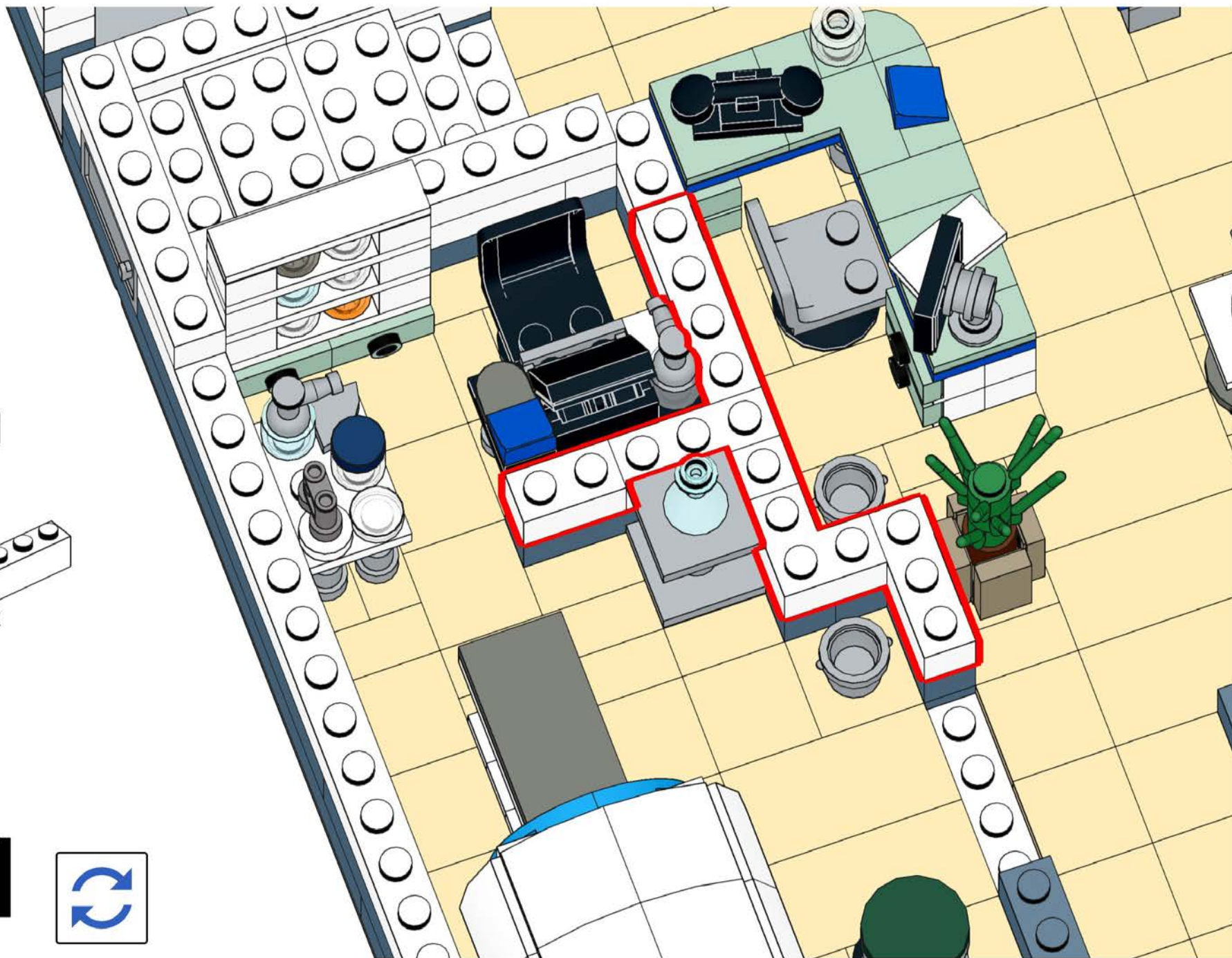

161



# 162

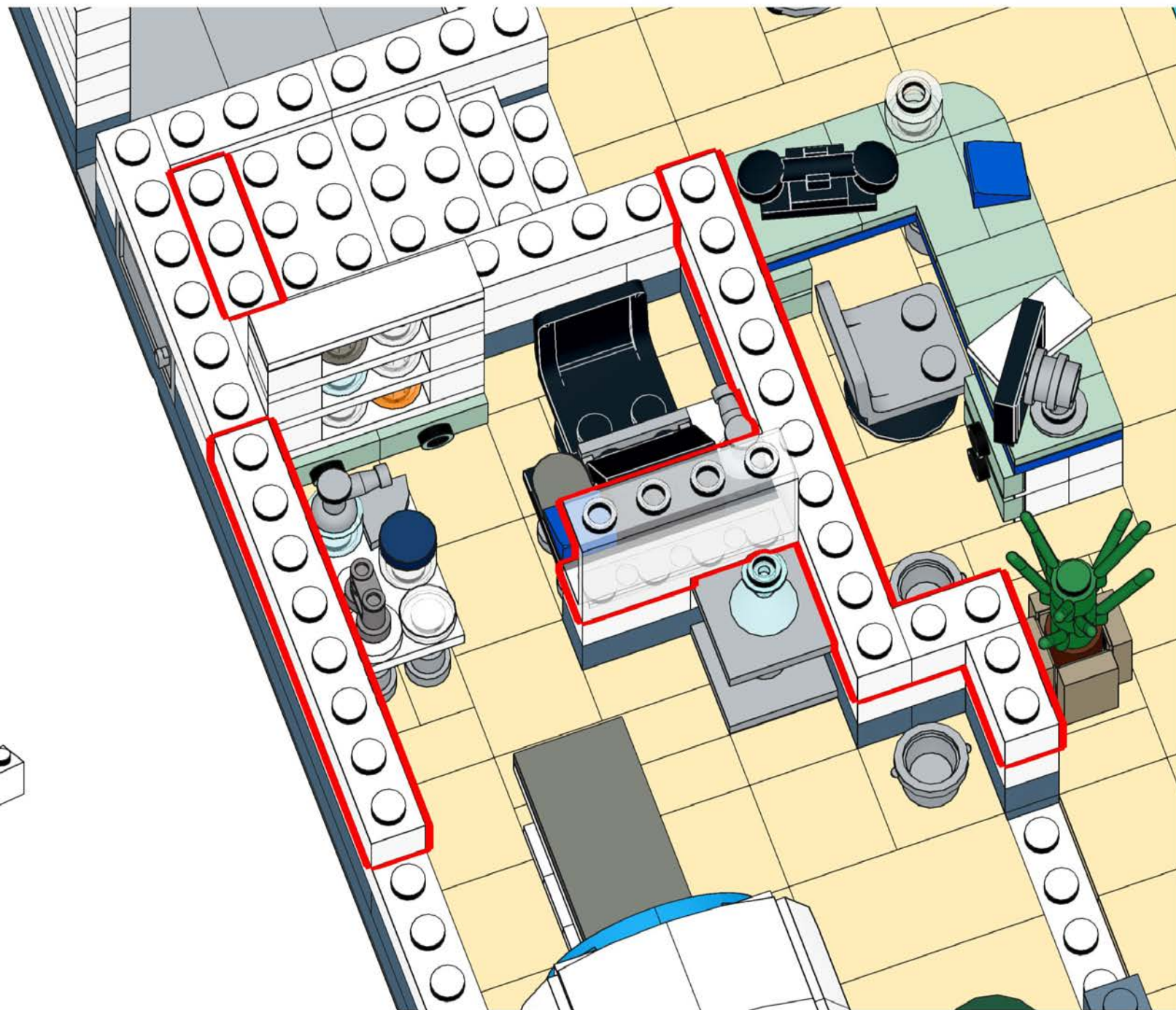
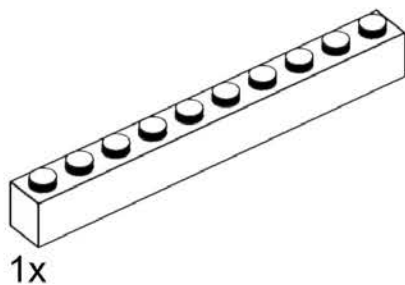
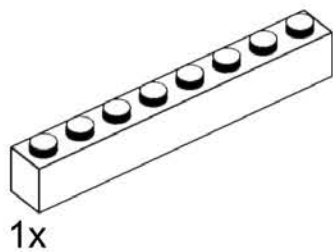
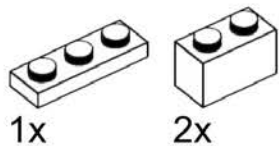



# 163

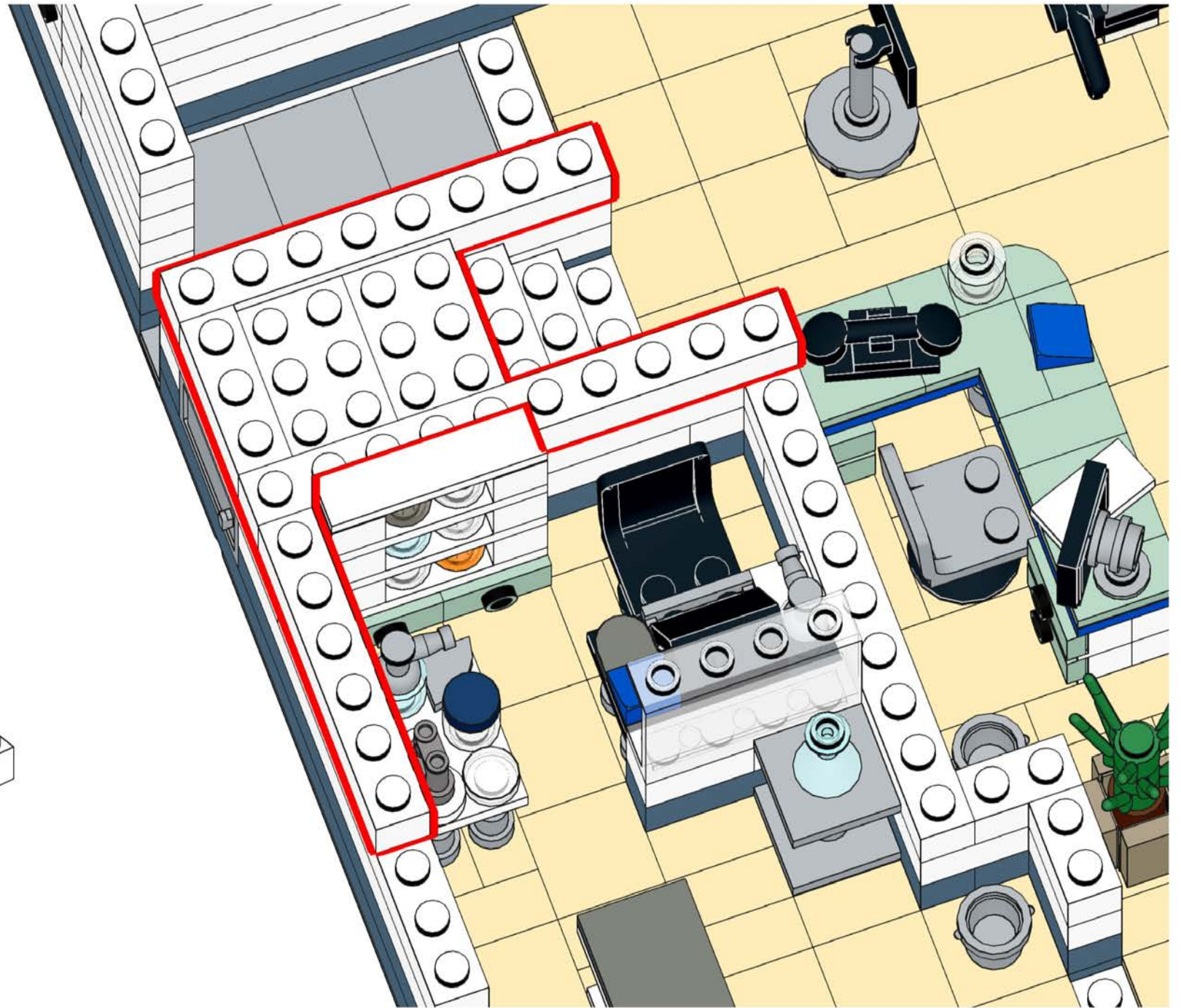
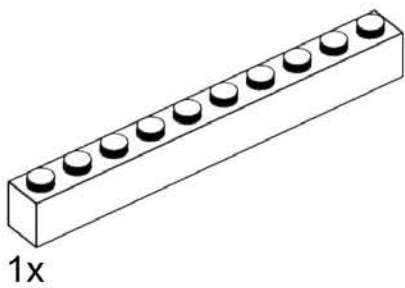
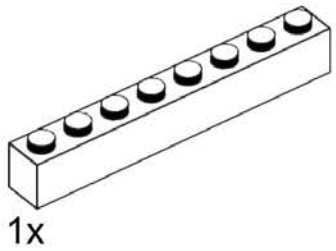
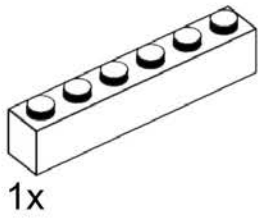
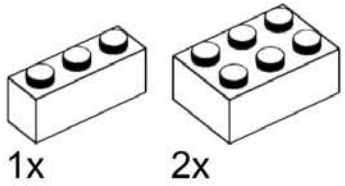



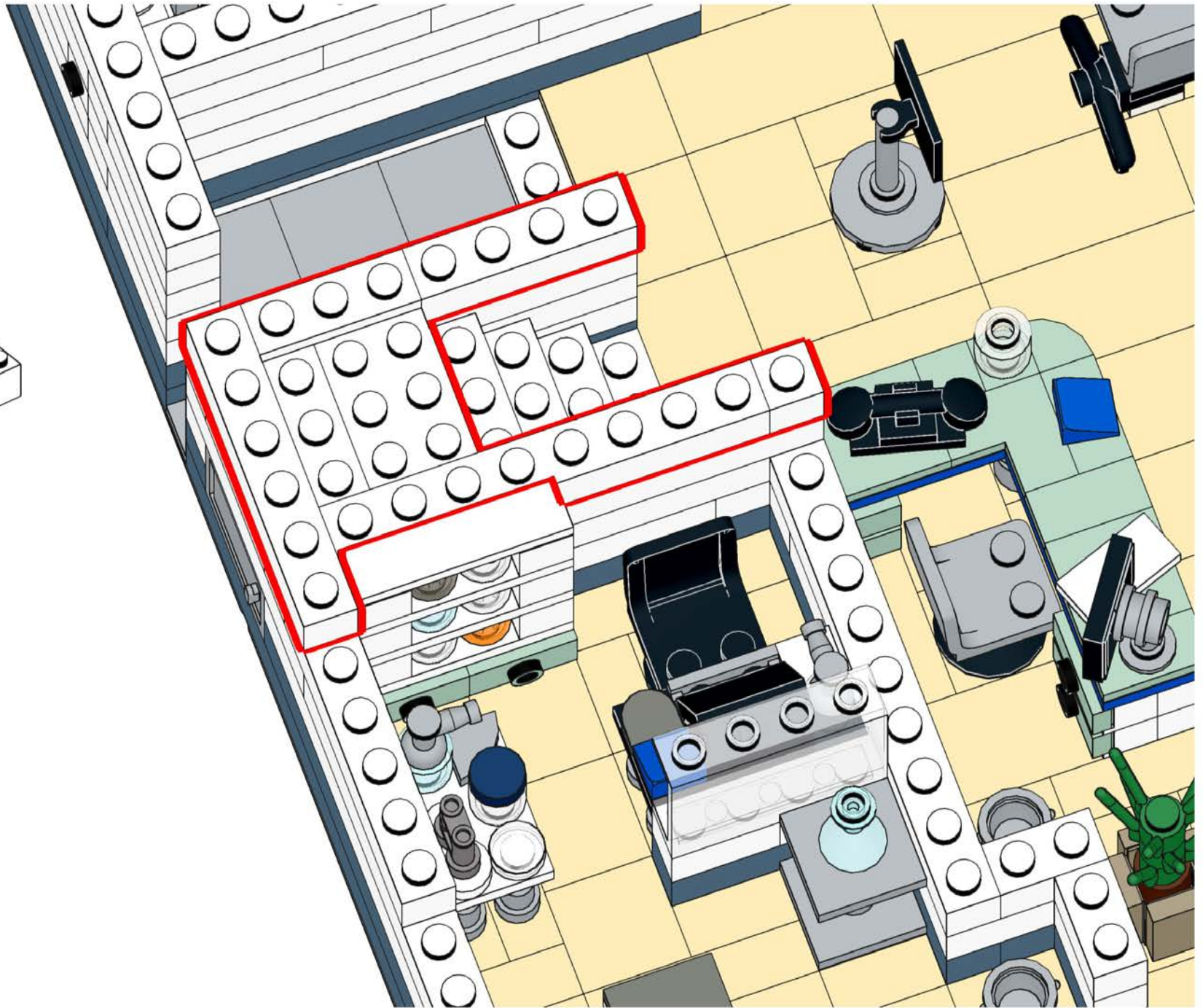
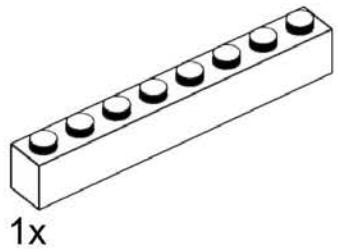
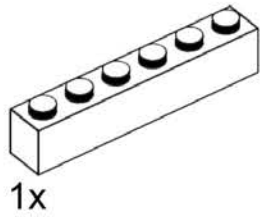
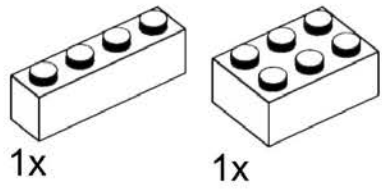
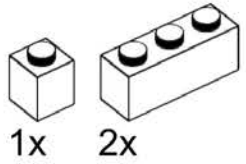

# 164

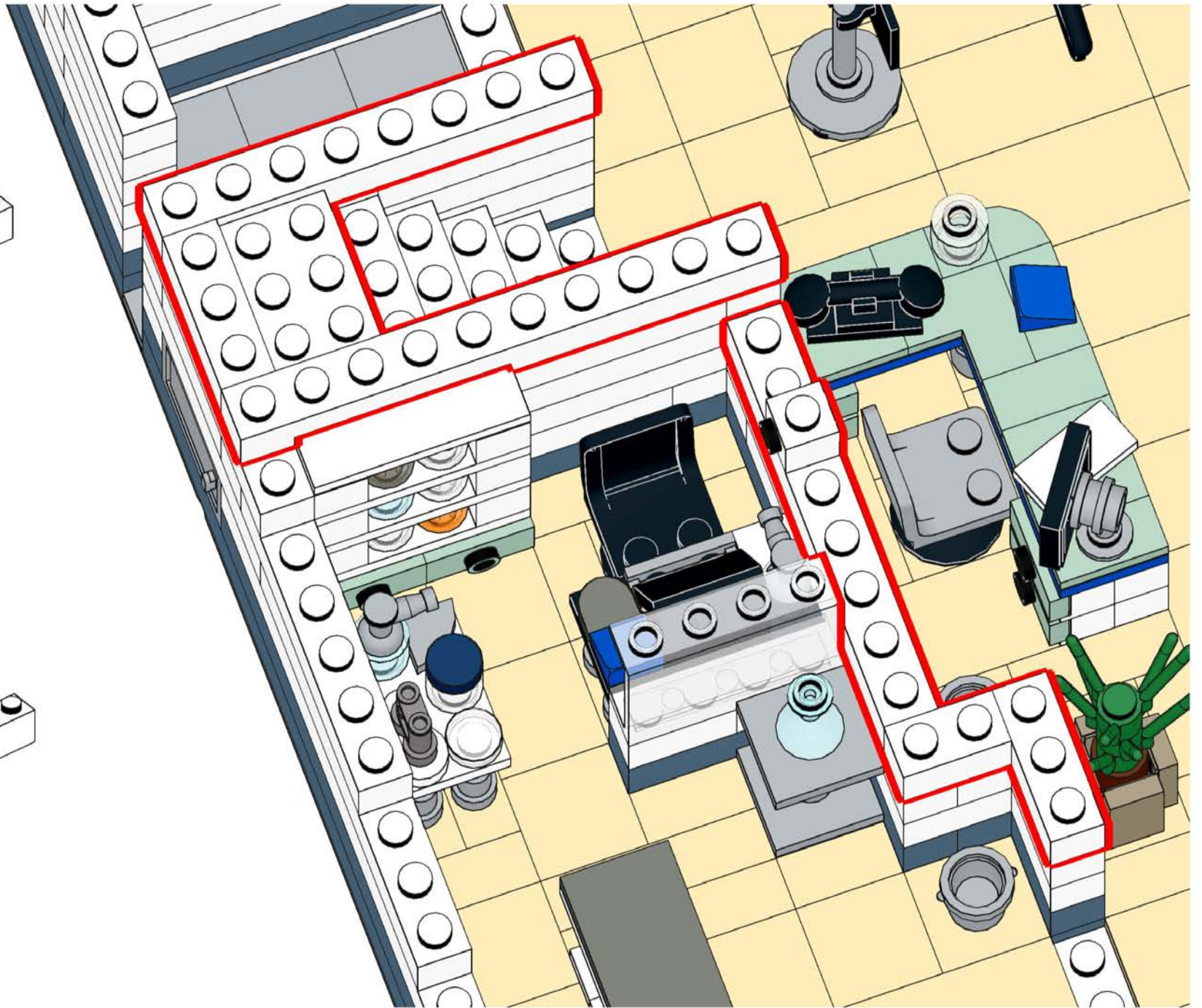
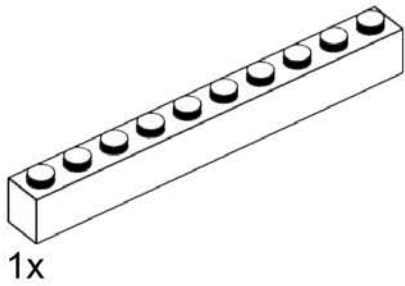
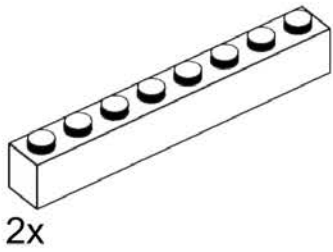
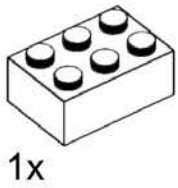
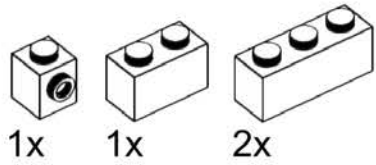

# 165

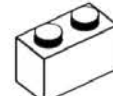

# 166

- 1x 
- 1x 
- 1x 
- 3x 
- 1x 
- 1x 

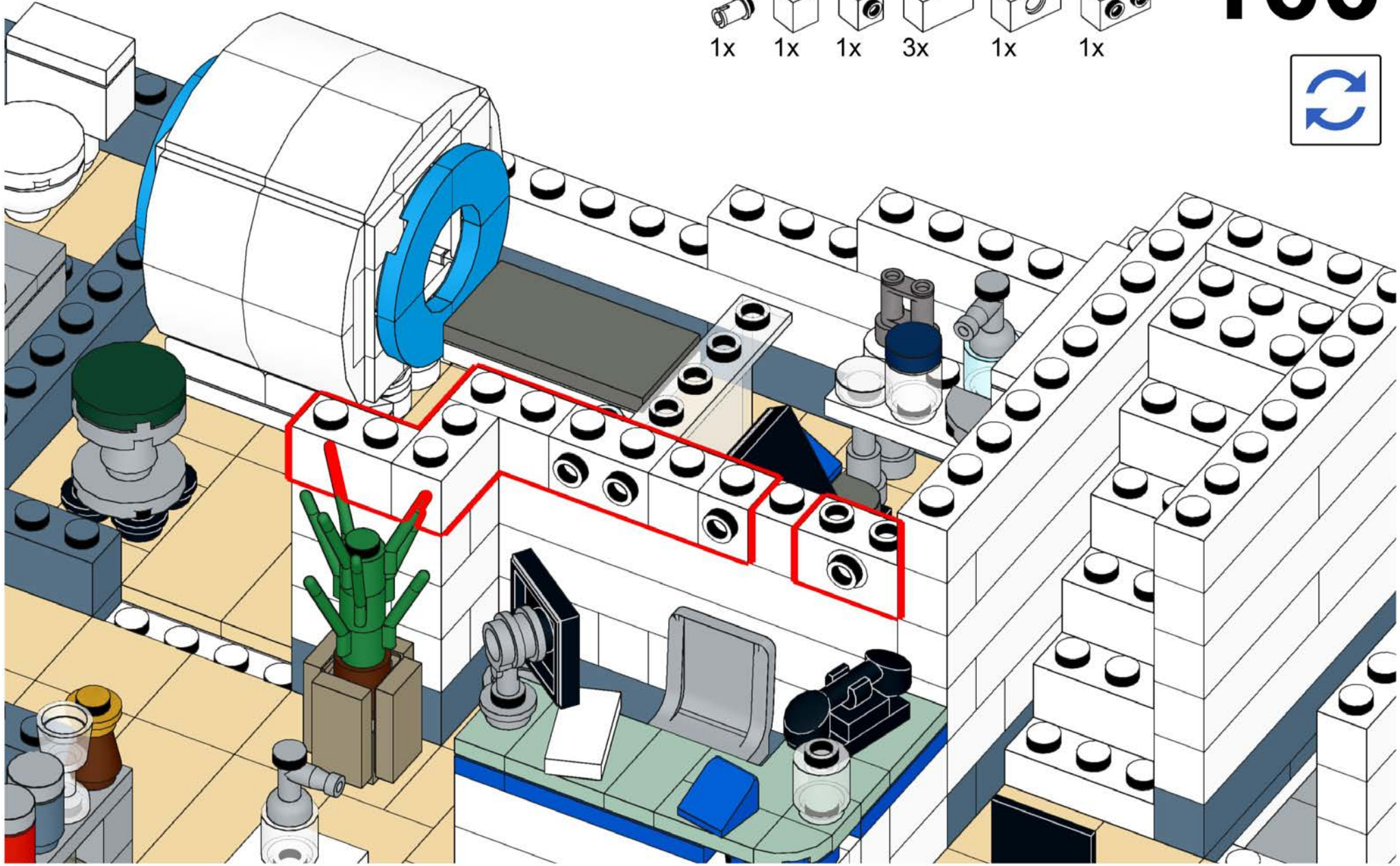

# 167

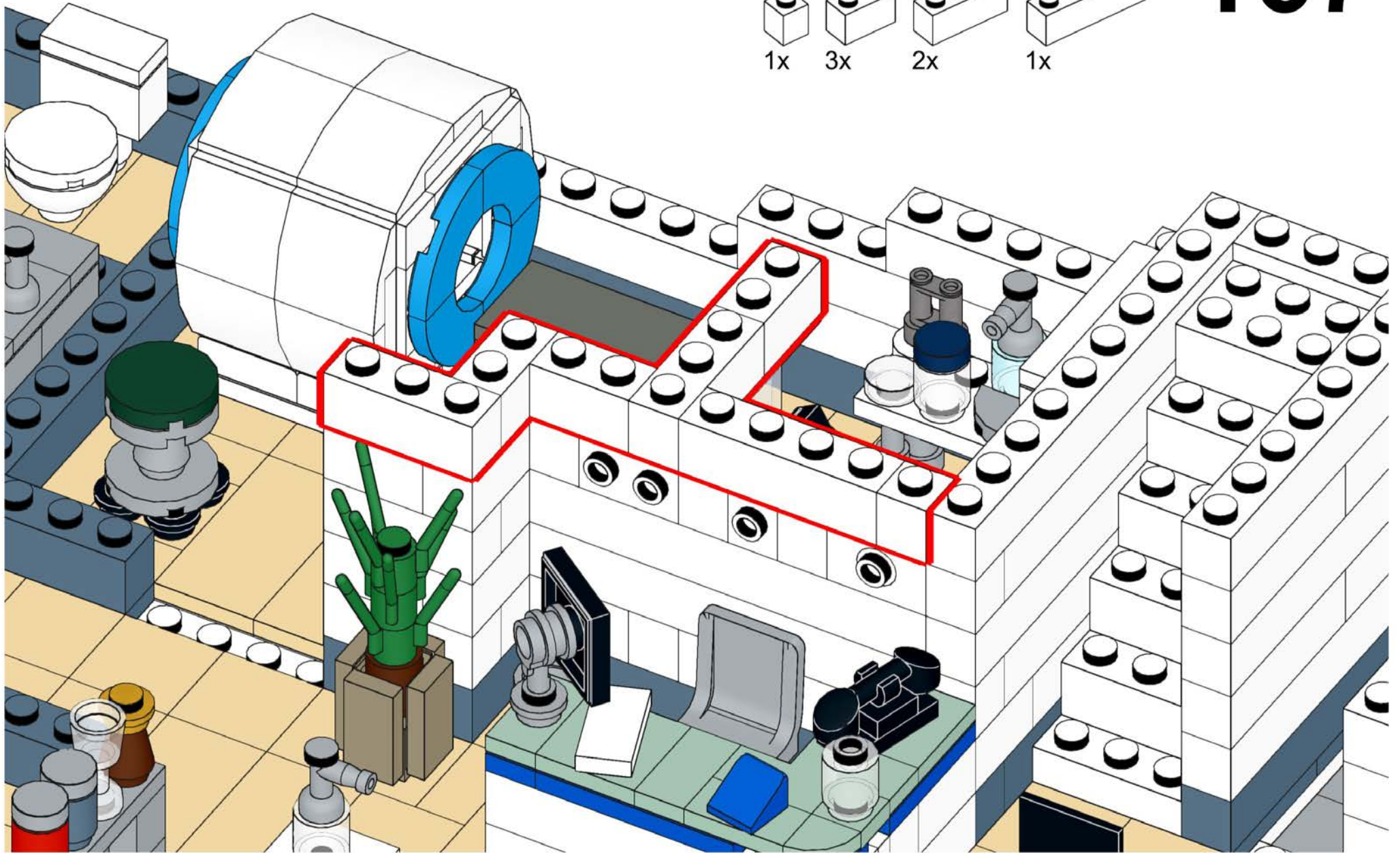
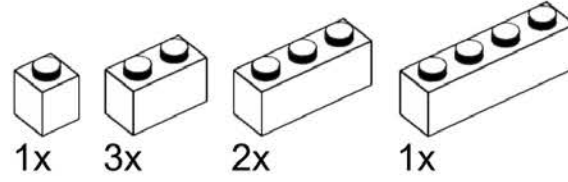

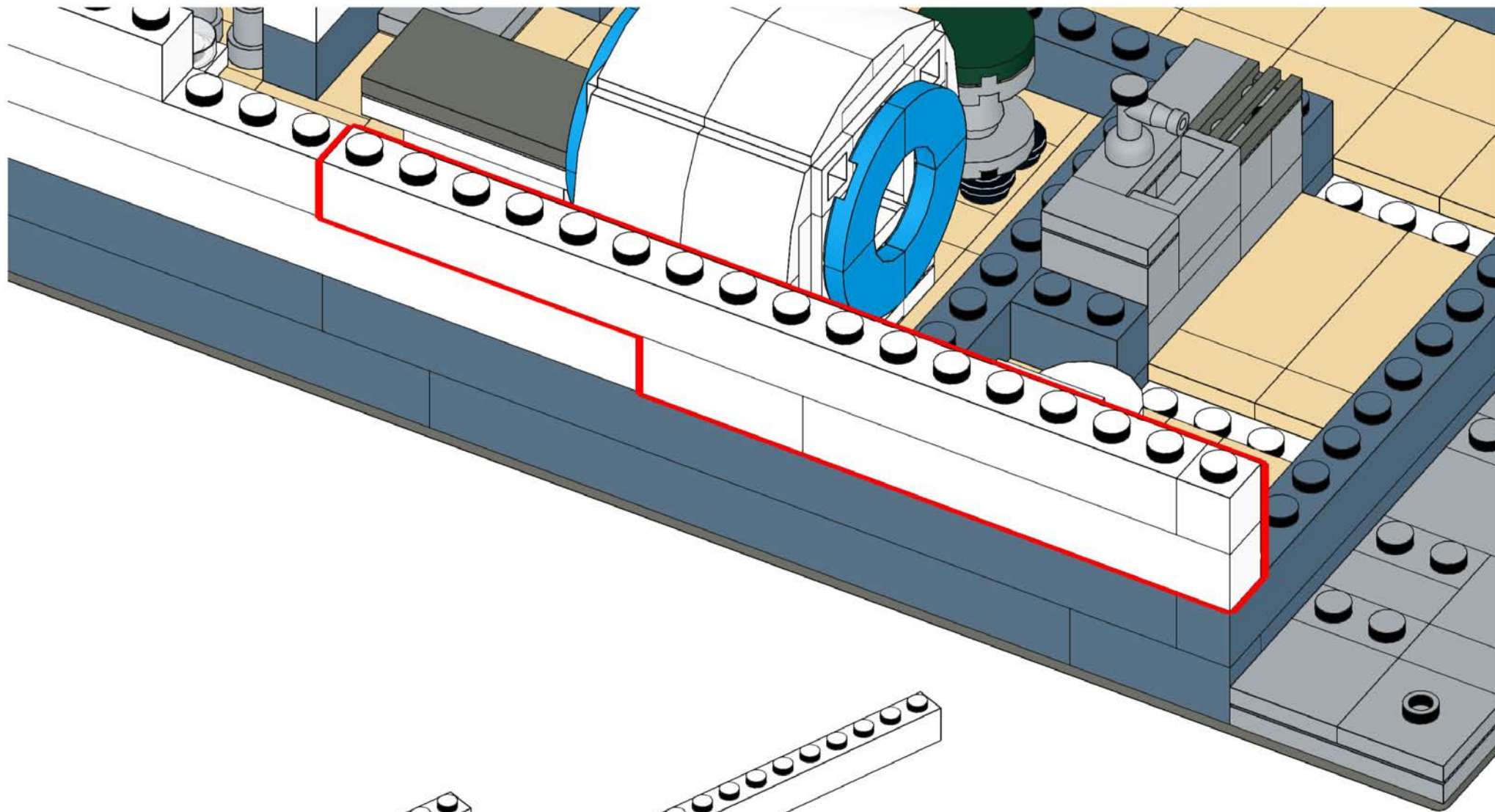

1x

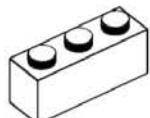

1x

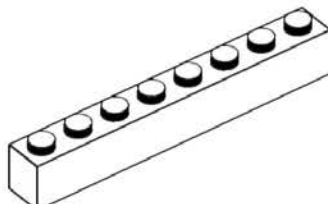

1x

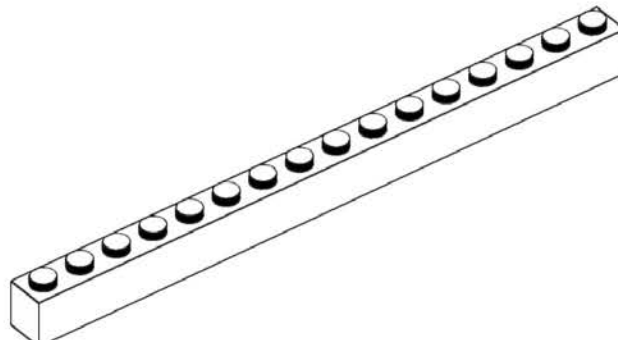

1x

# 168



# 169

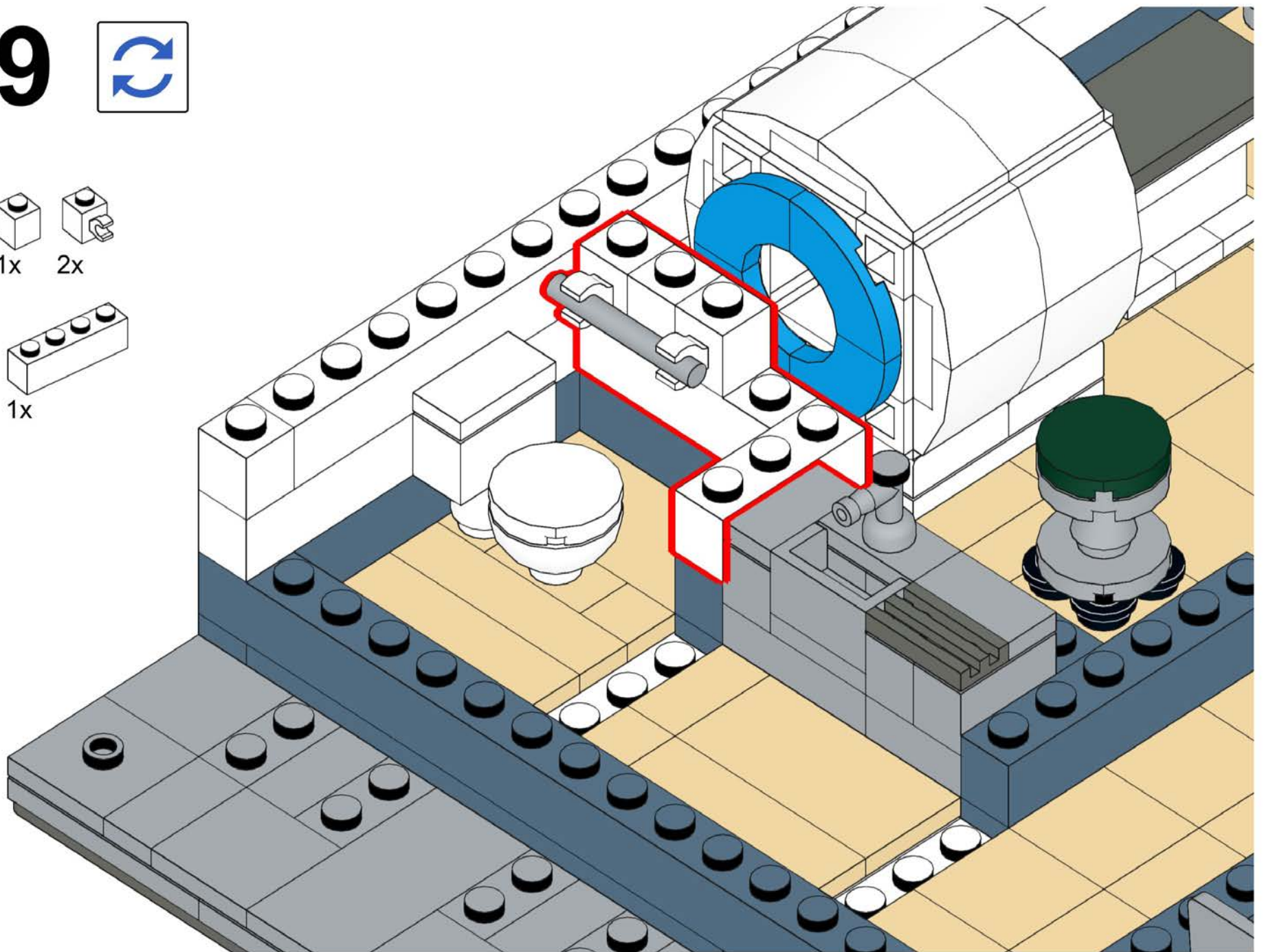
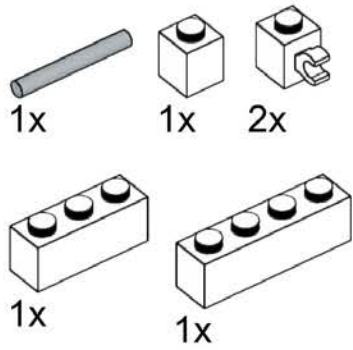

# 170

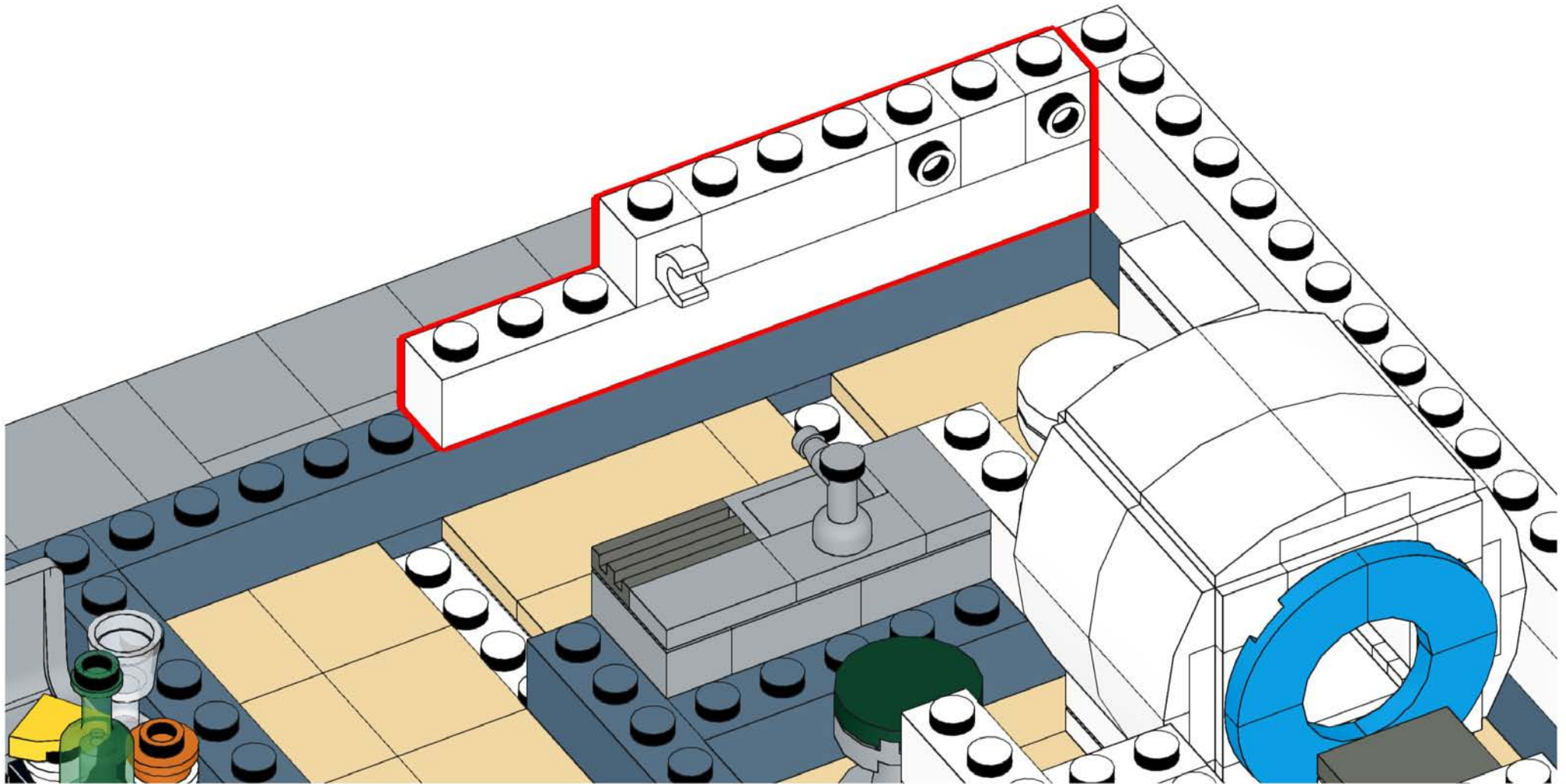
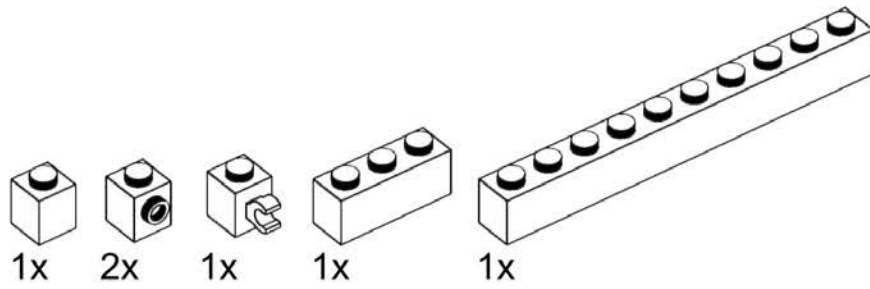



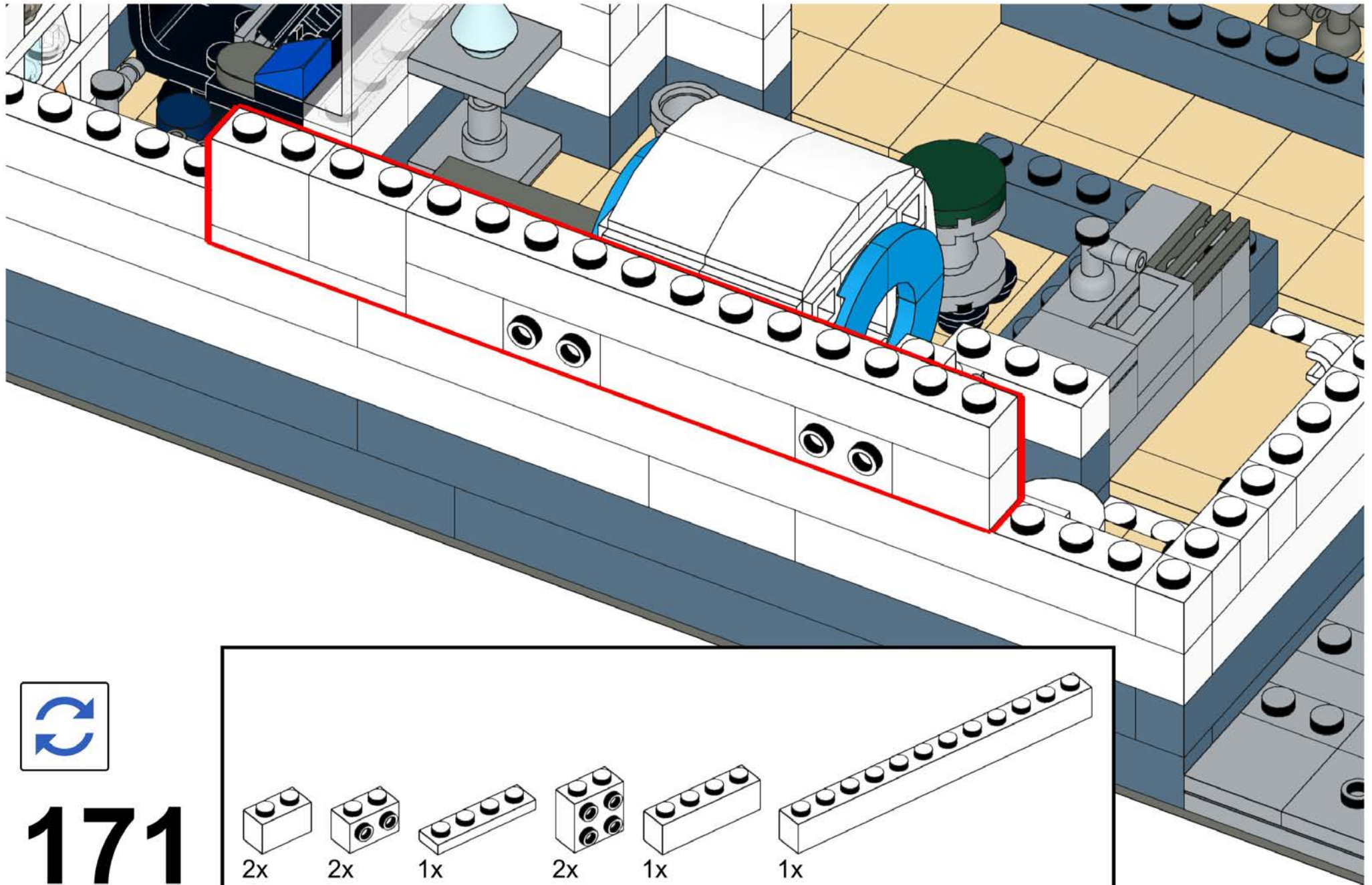

171

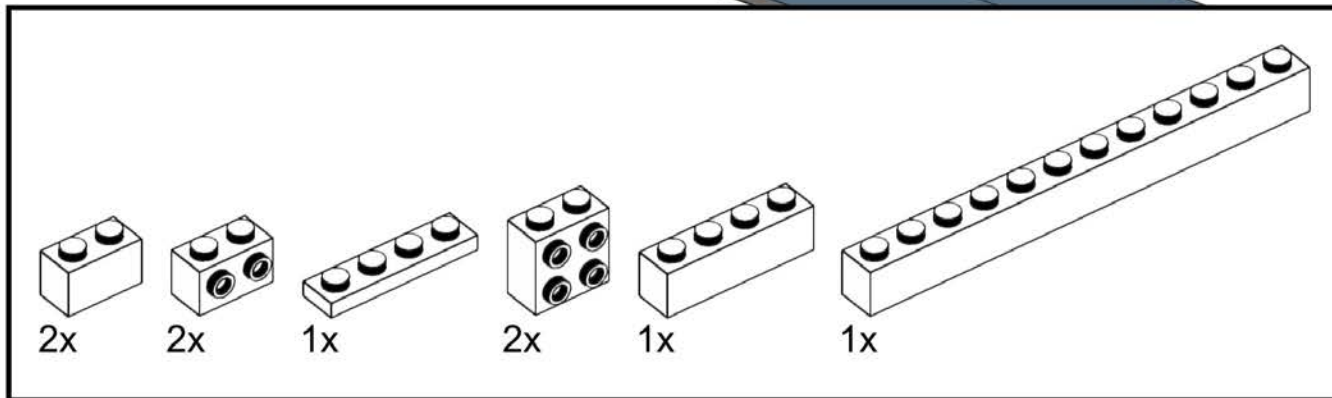

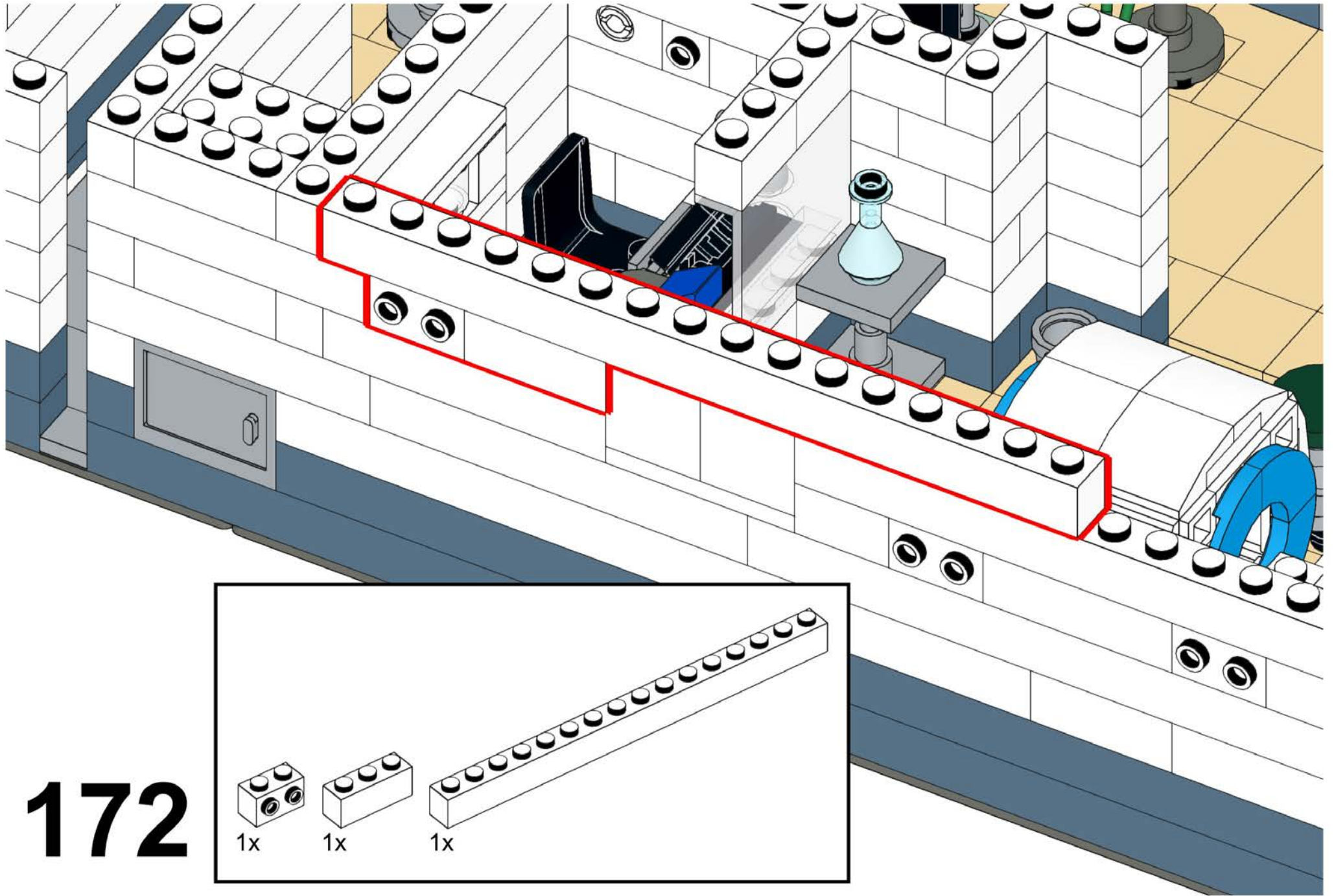

172

1x

1x

1x

# 173

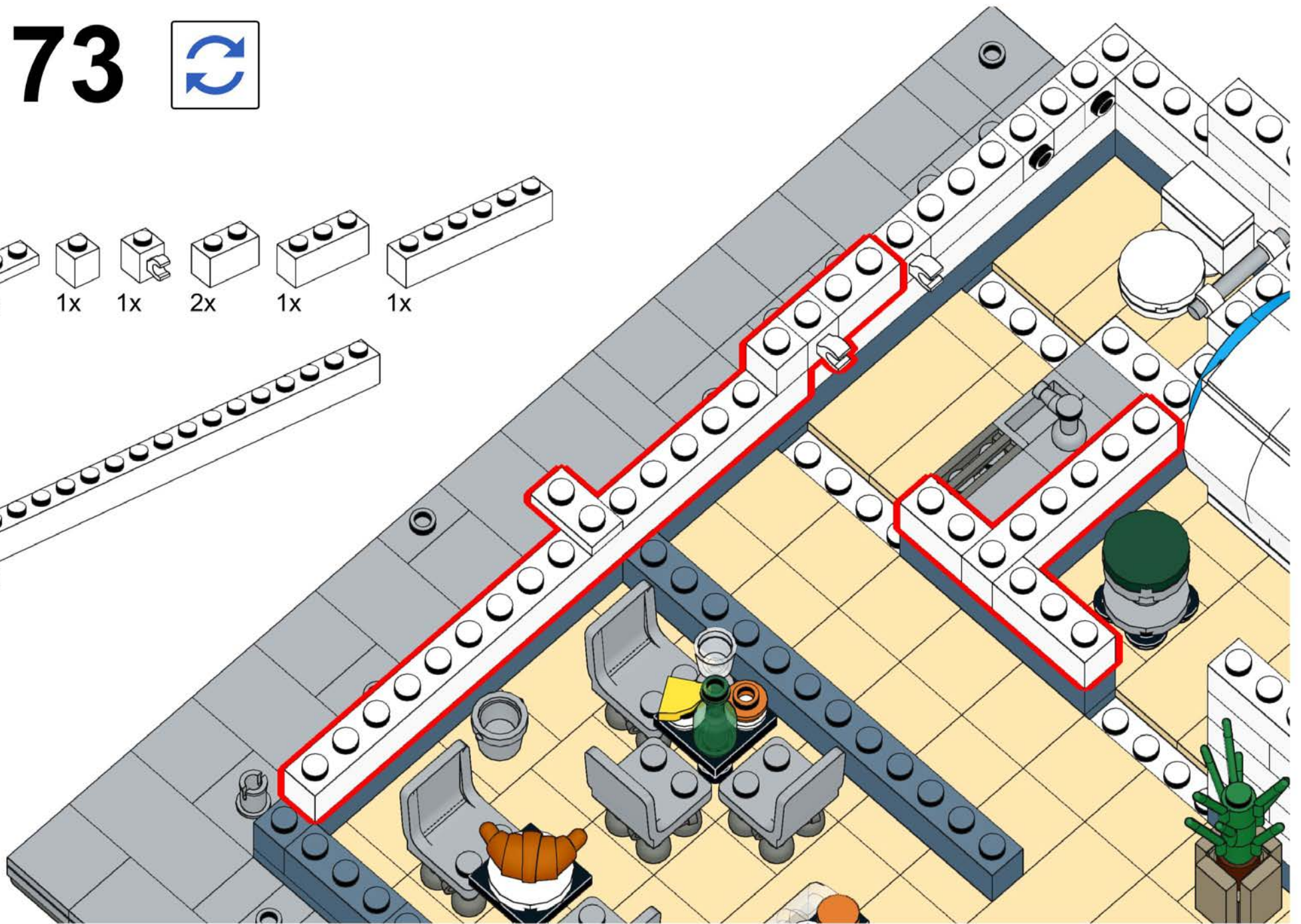
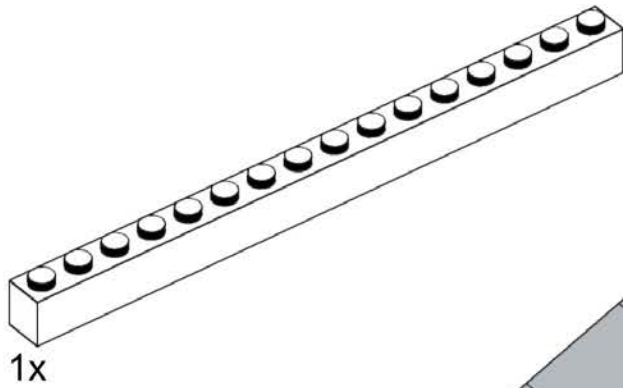
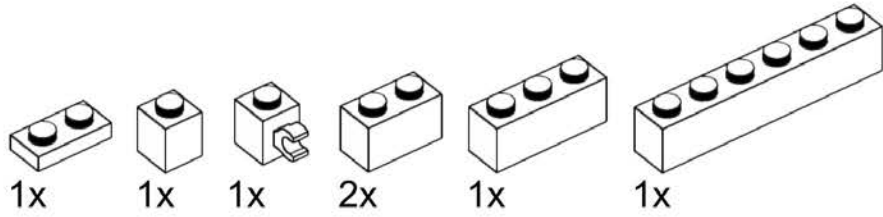

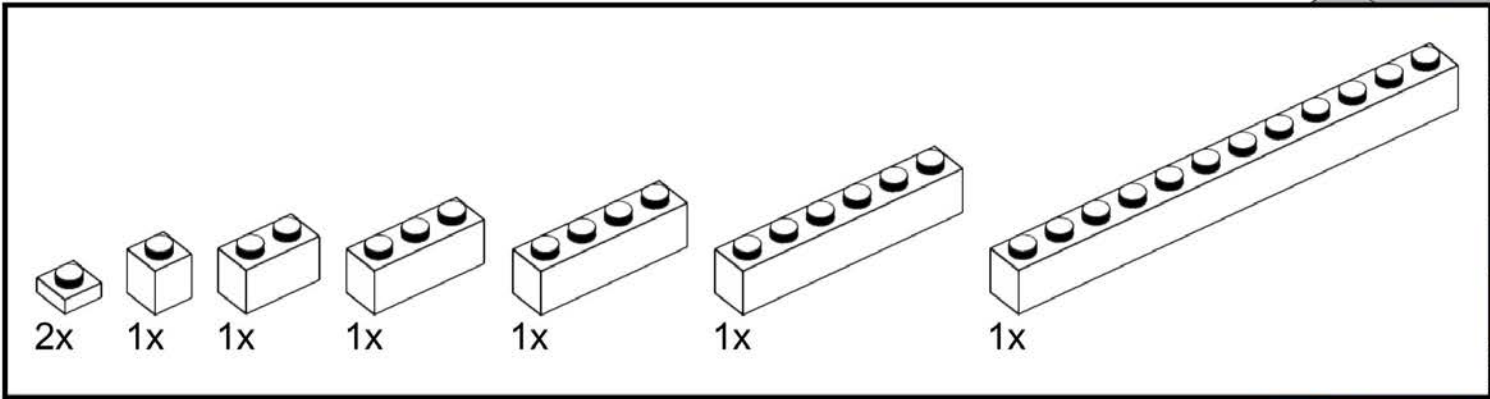

# 174

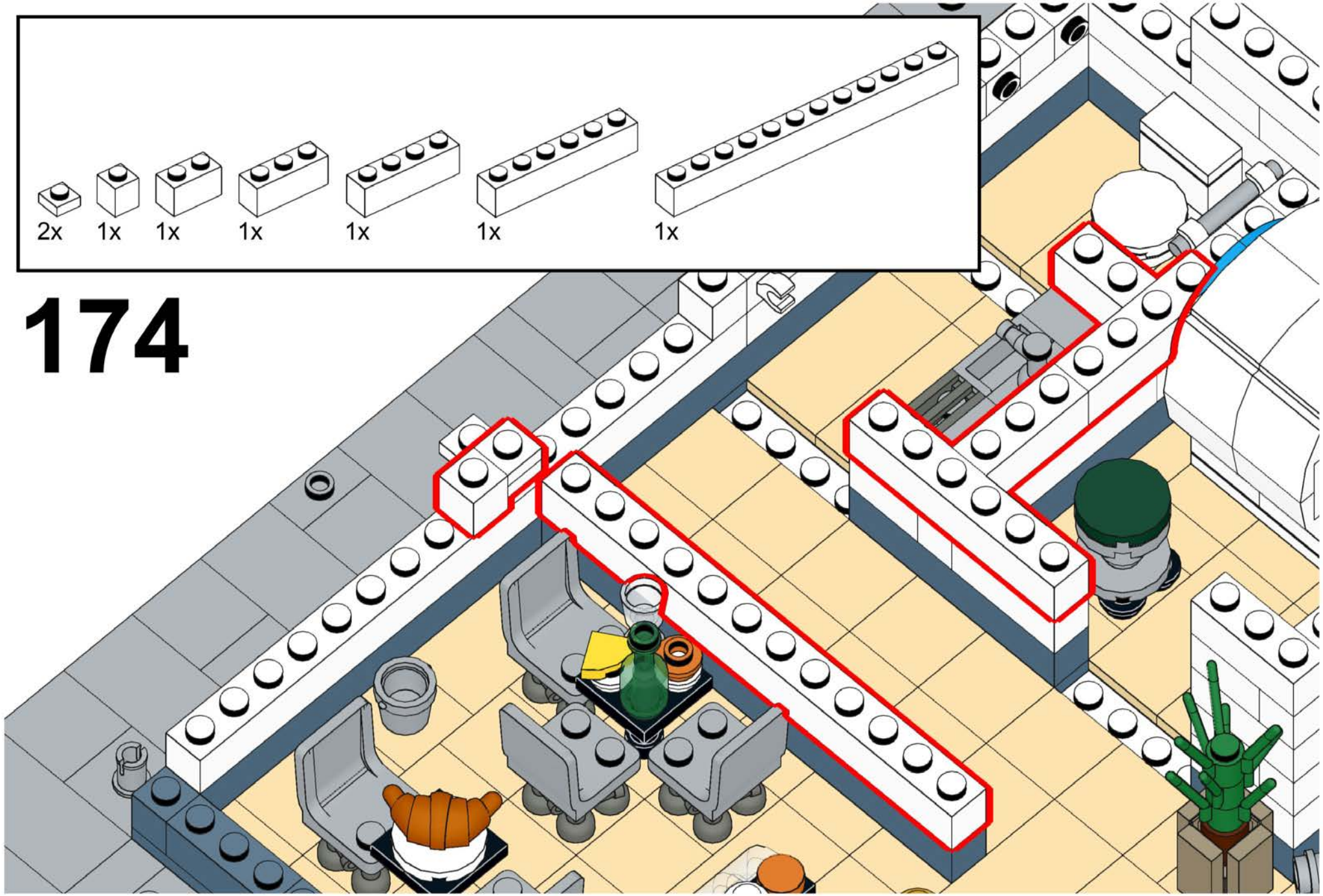

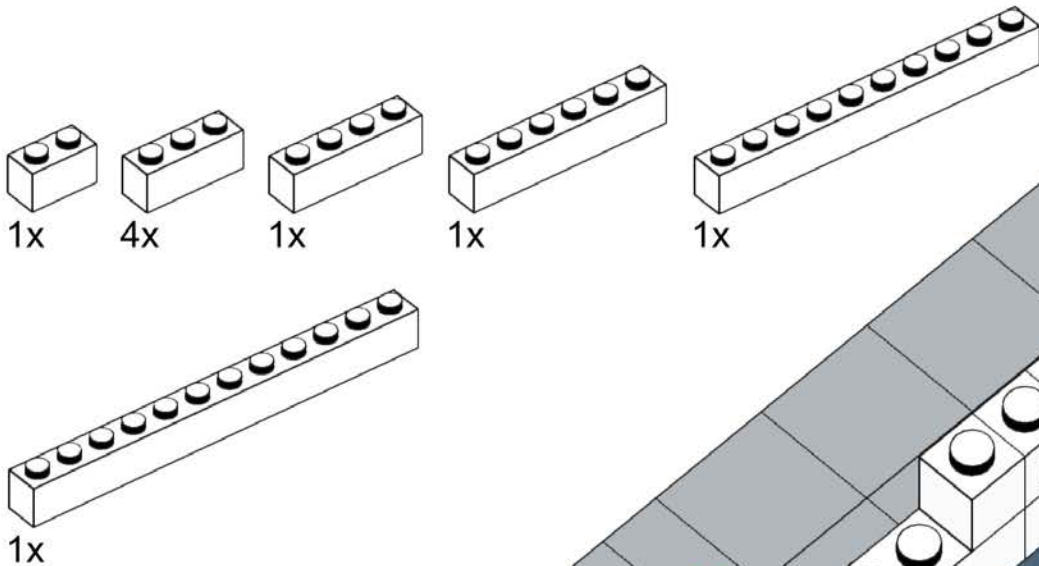

175

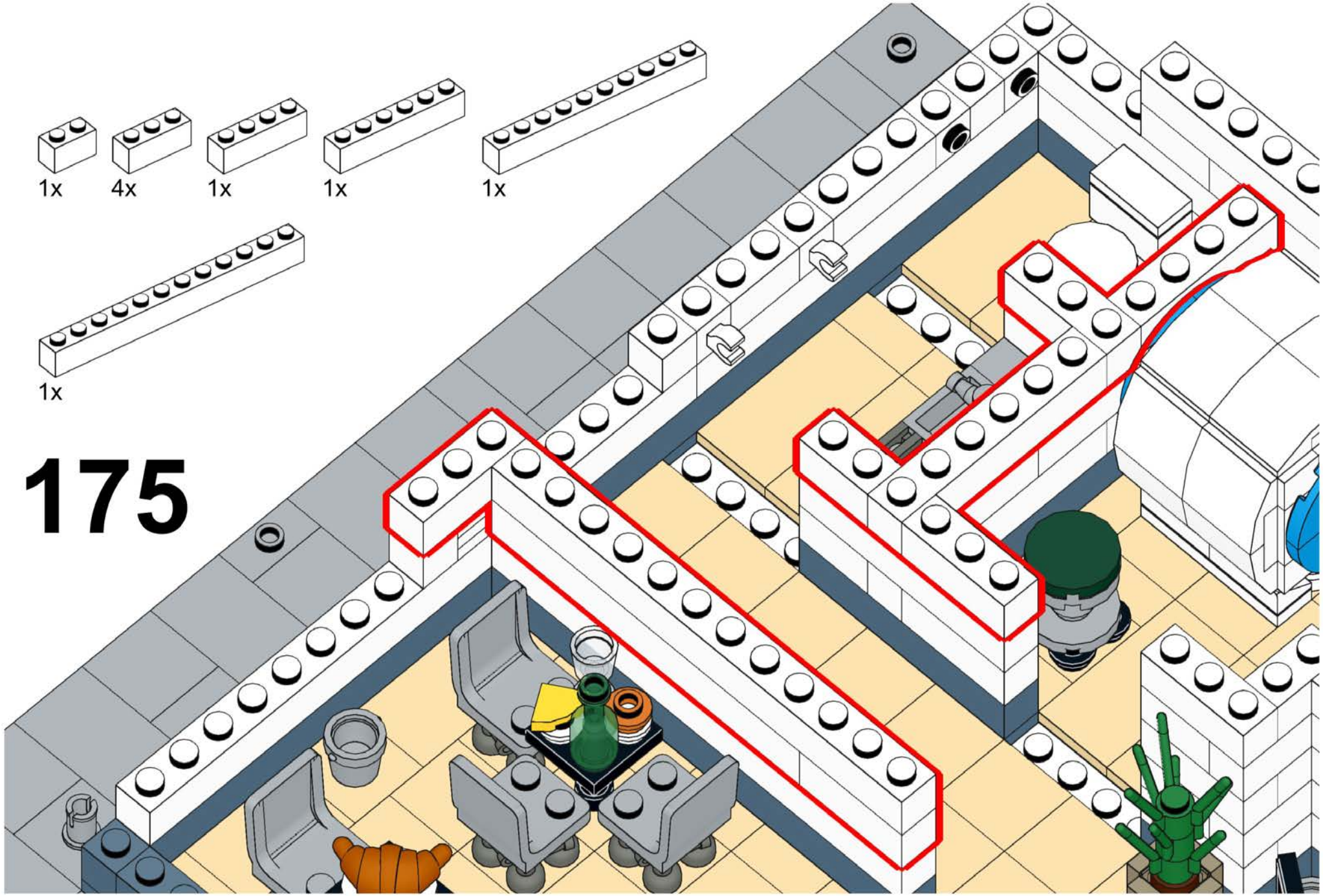

# 176

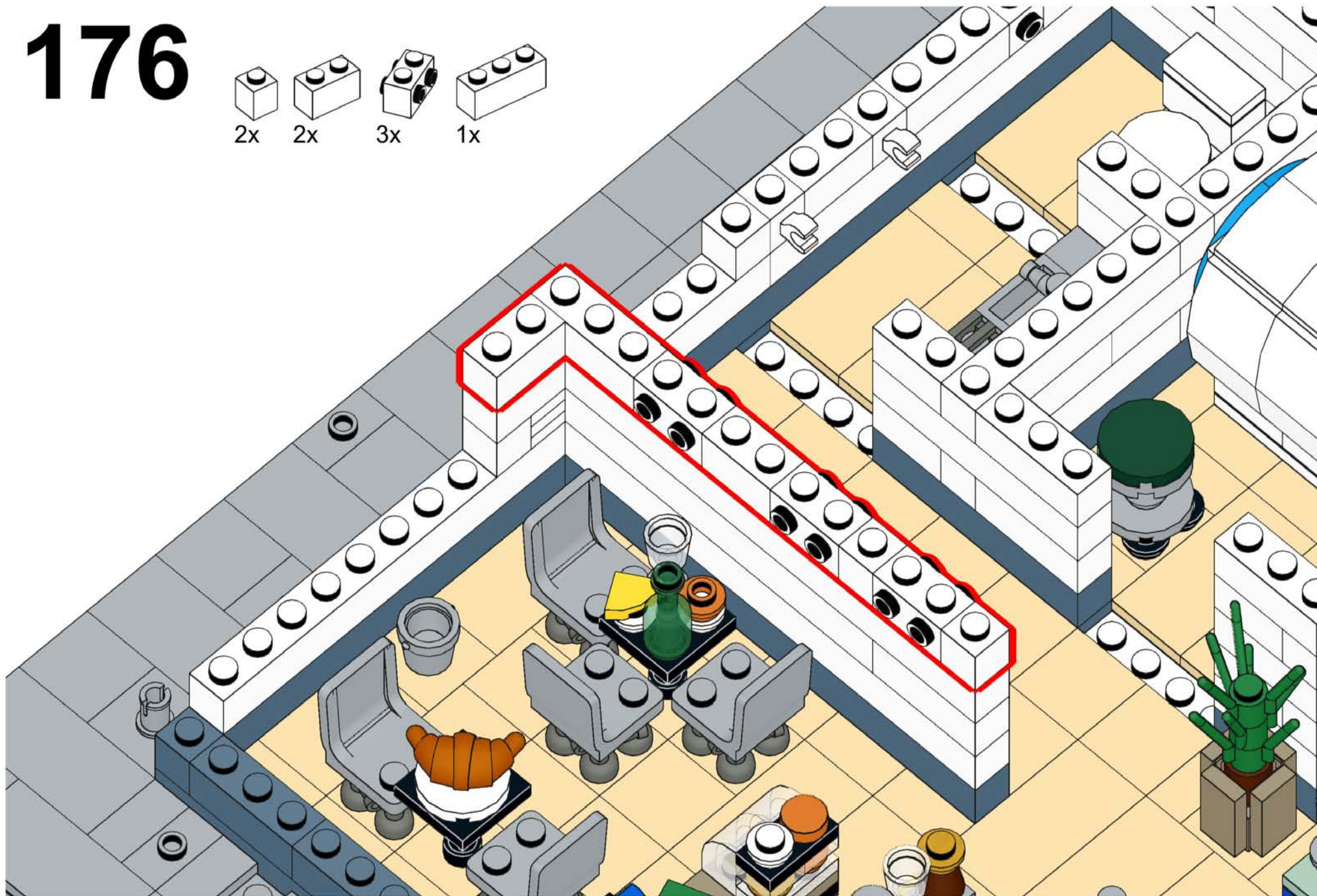
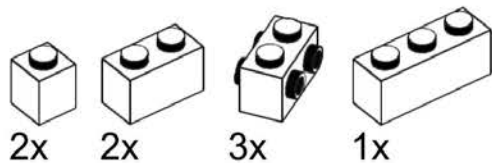

# 177

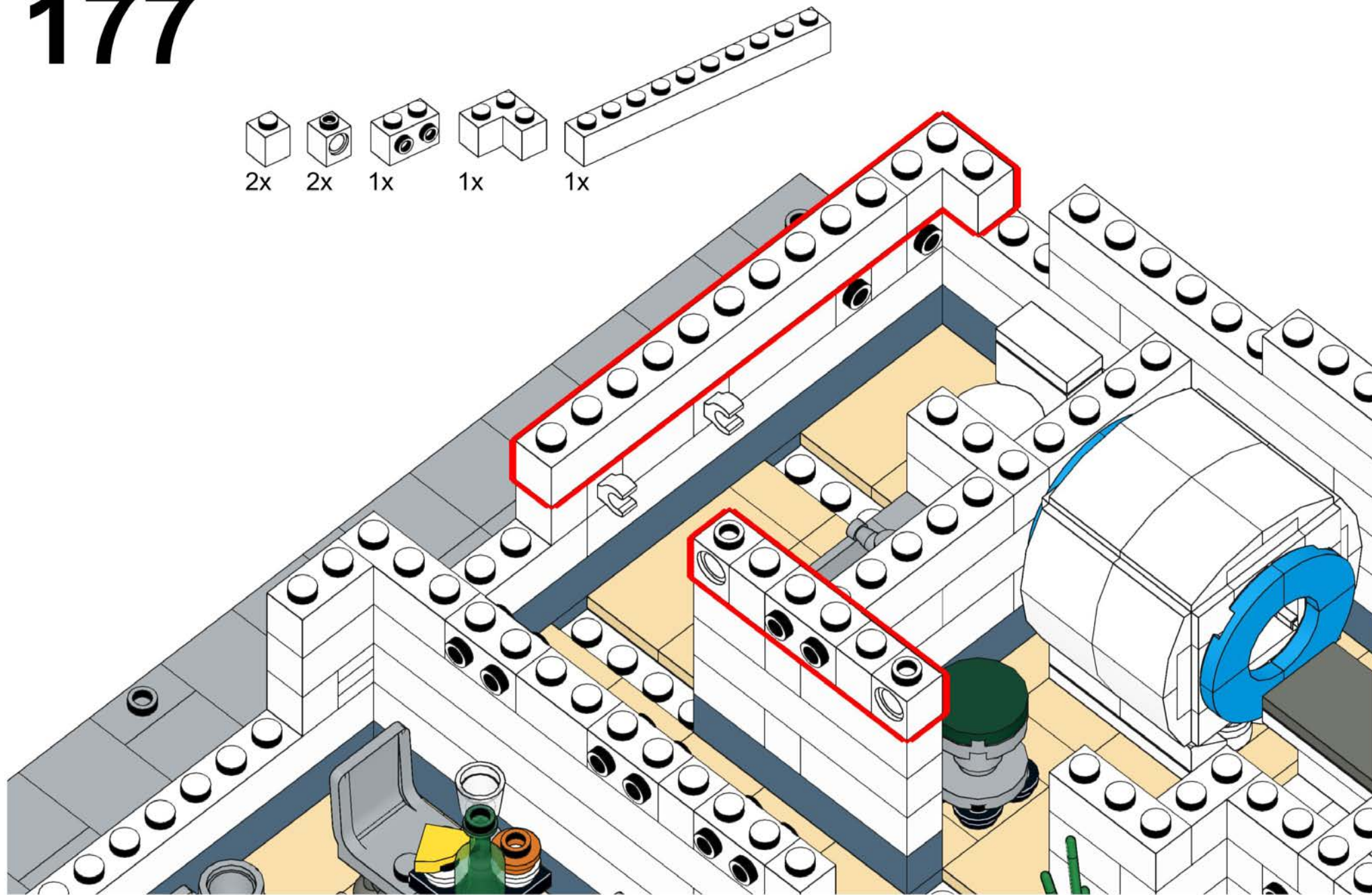
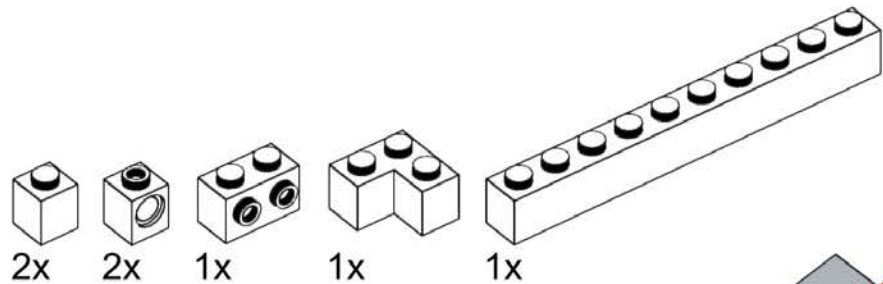

# 178

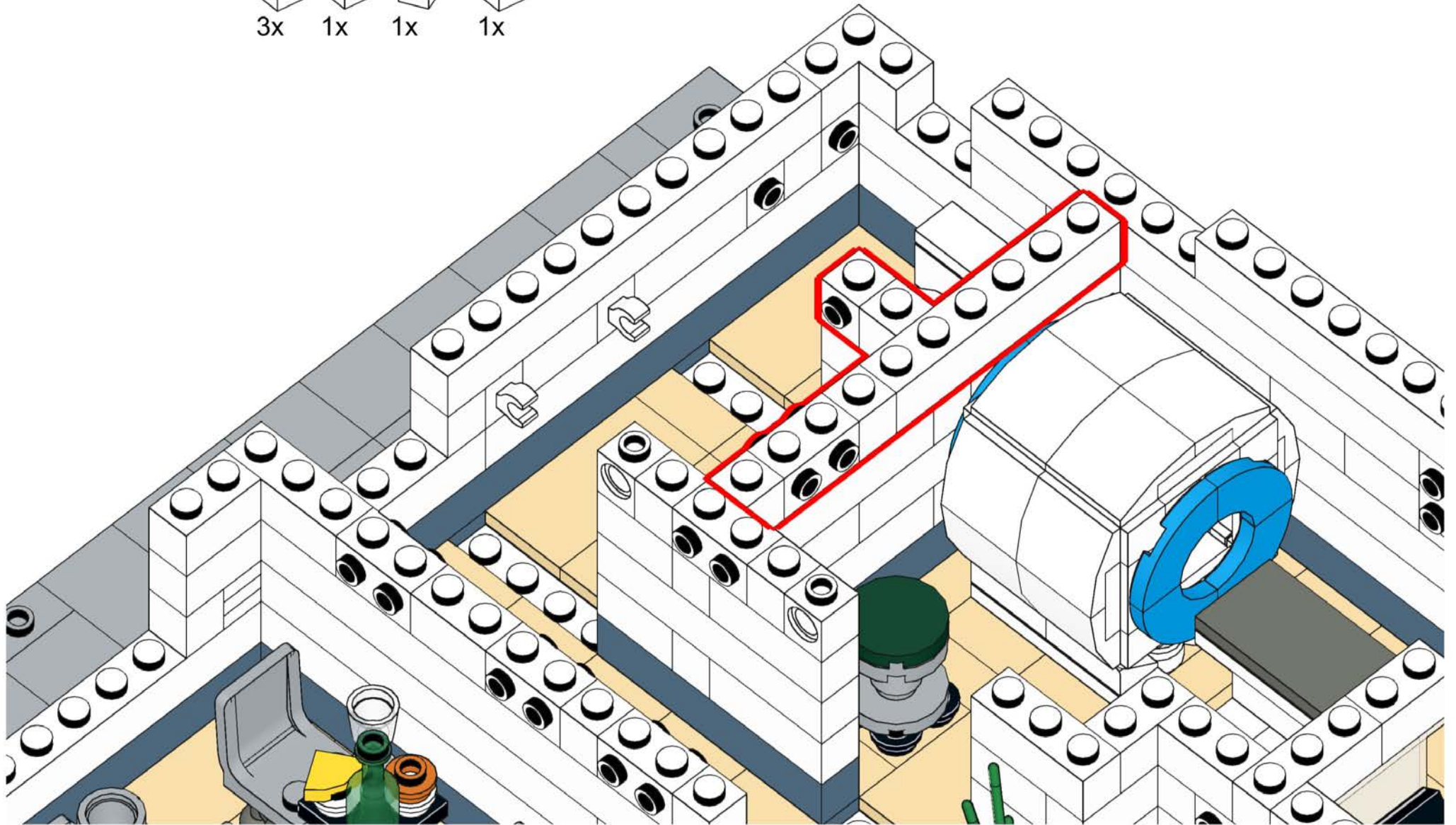
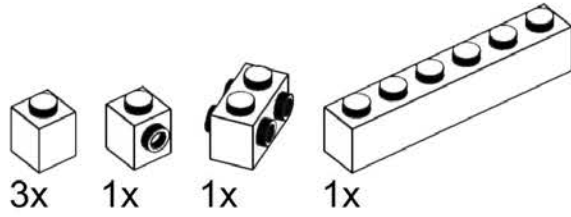



# 179

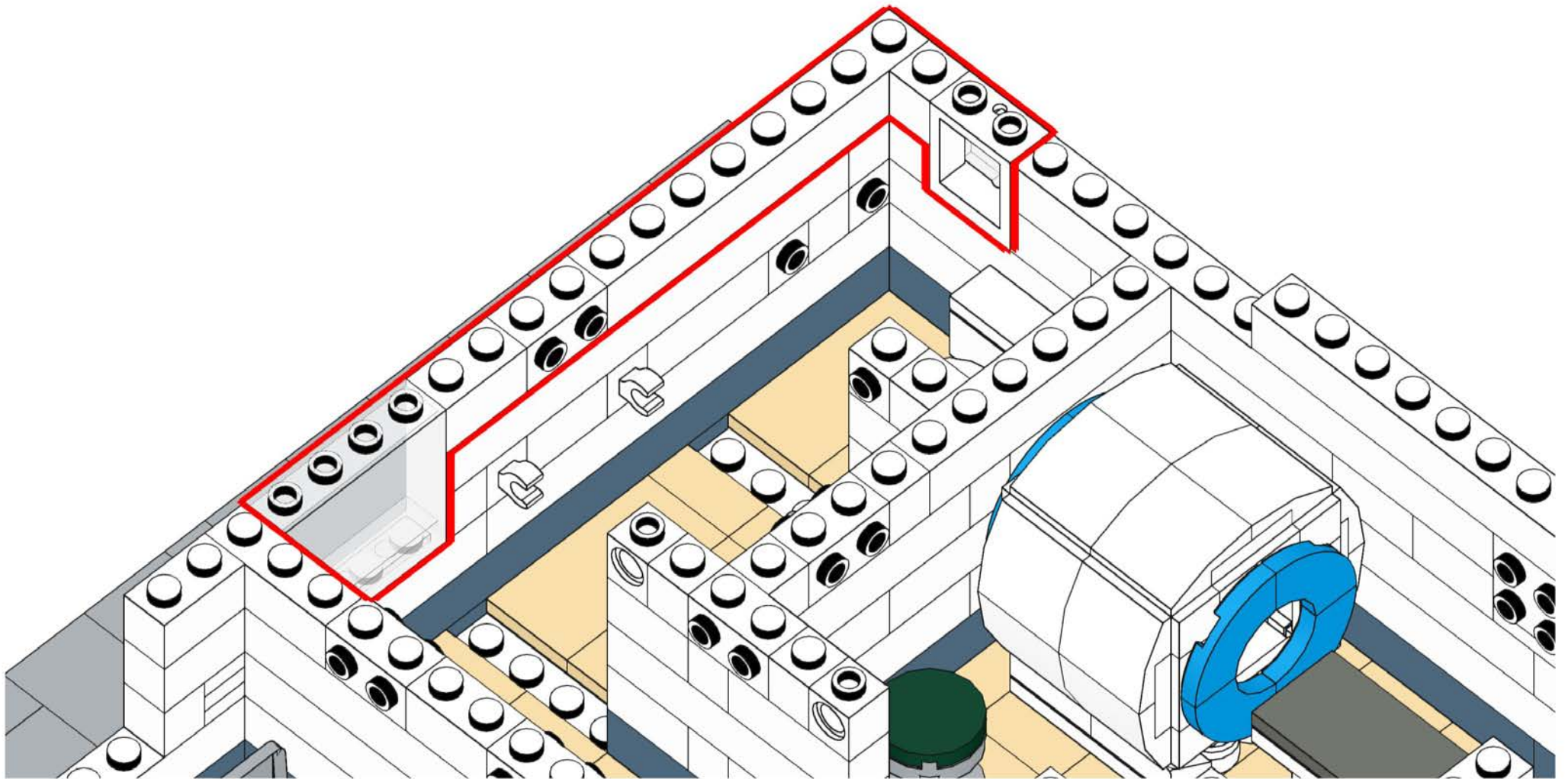
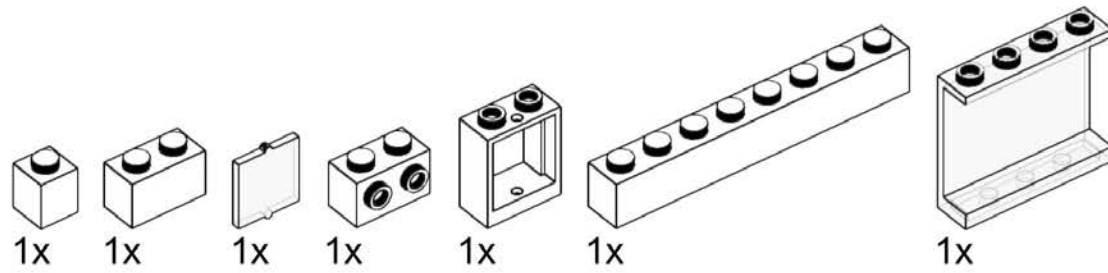

# 180



1x



2x



1x

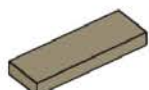

1x

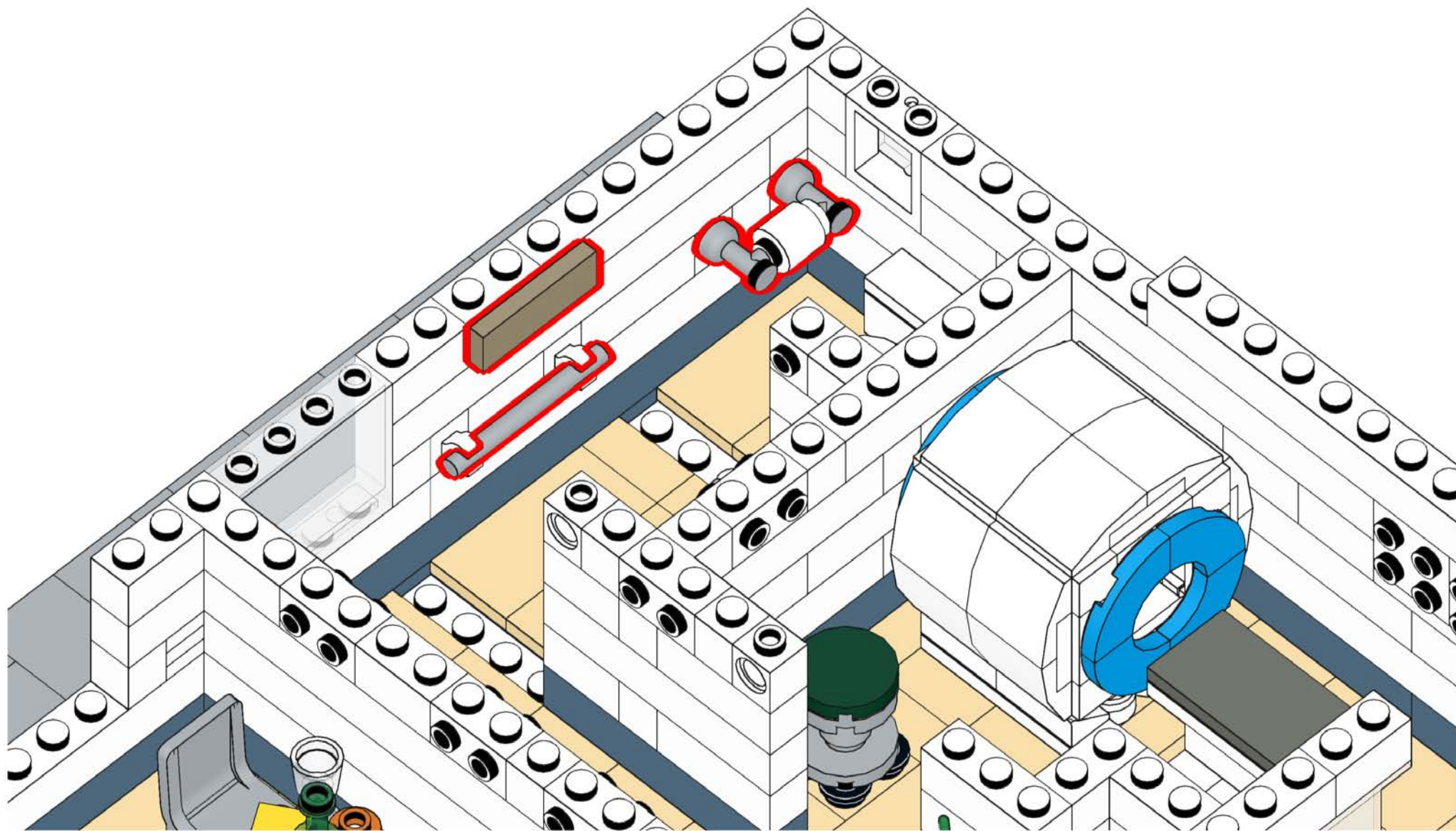

# 181

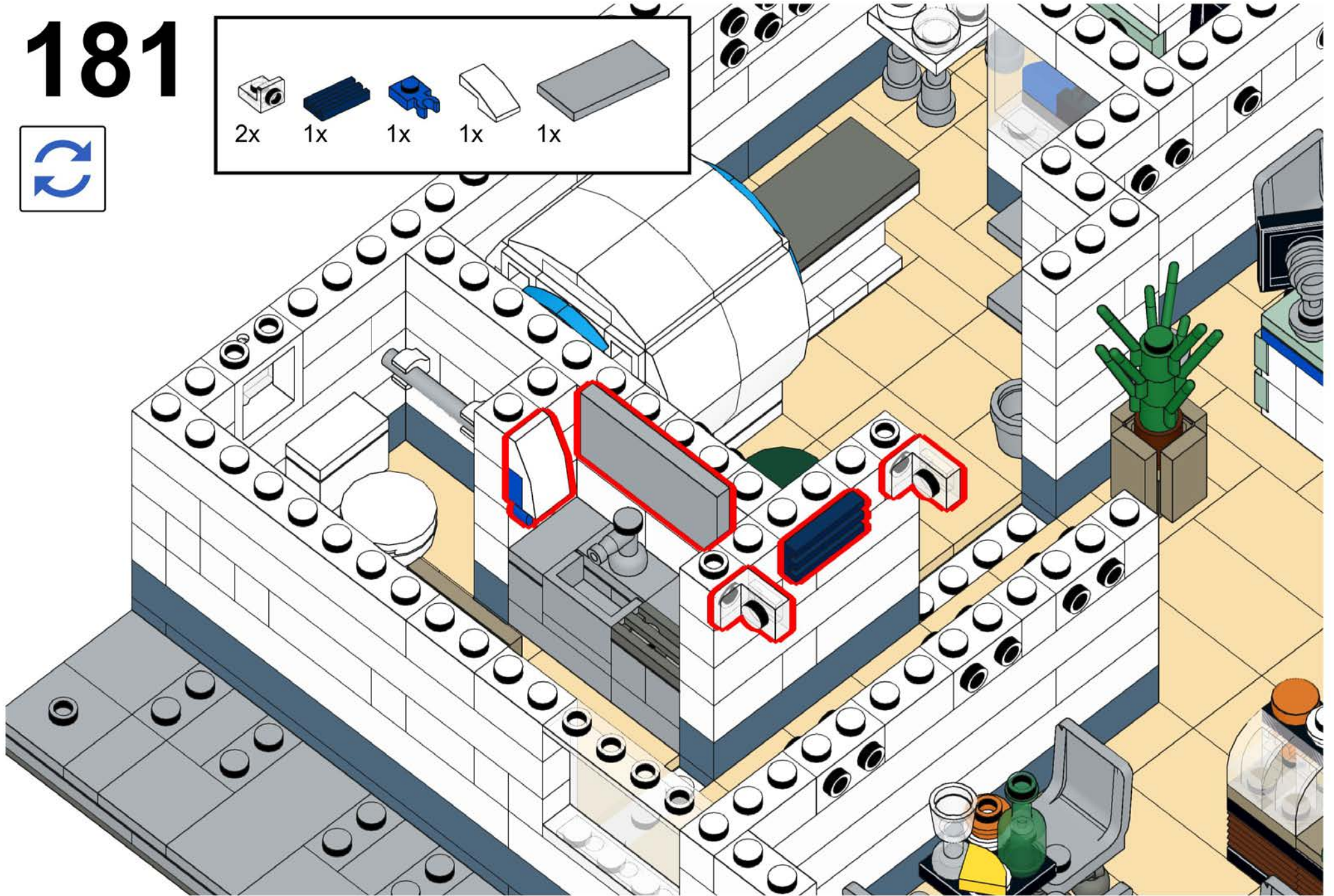
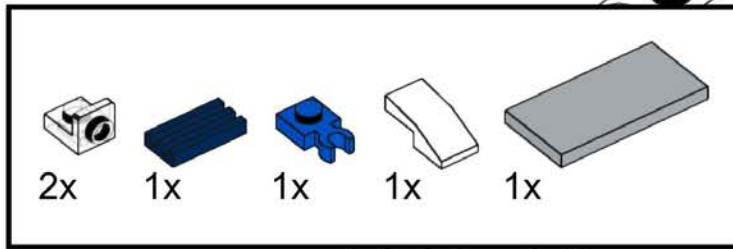

# 182

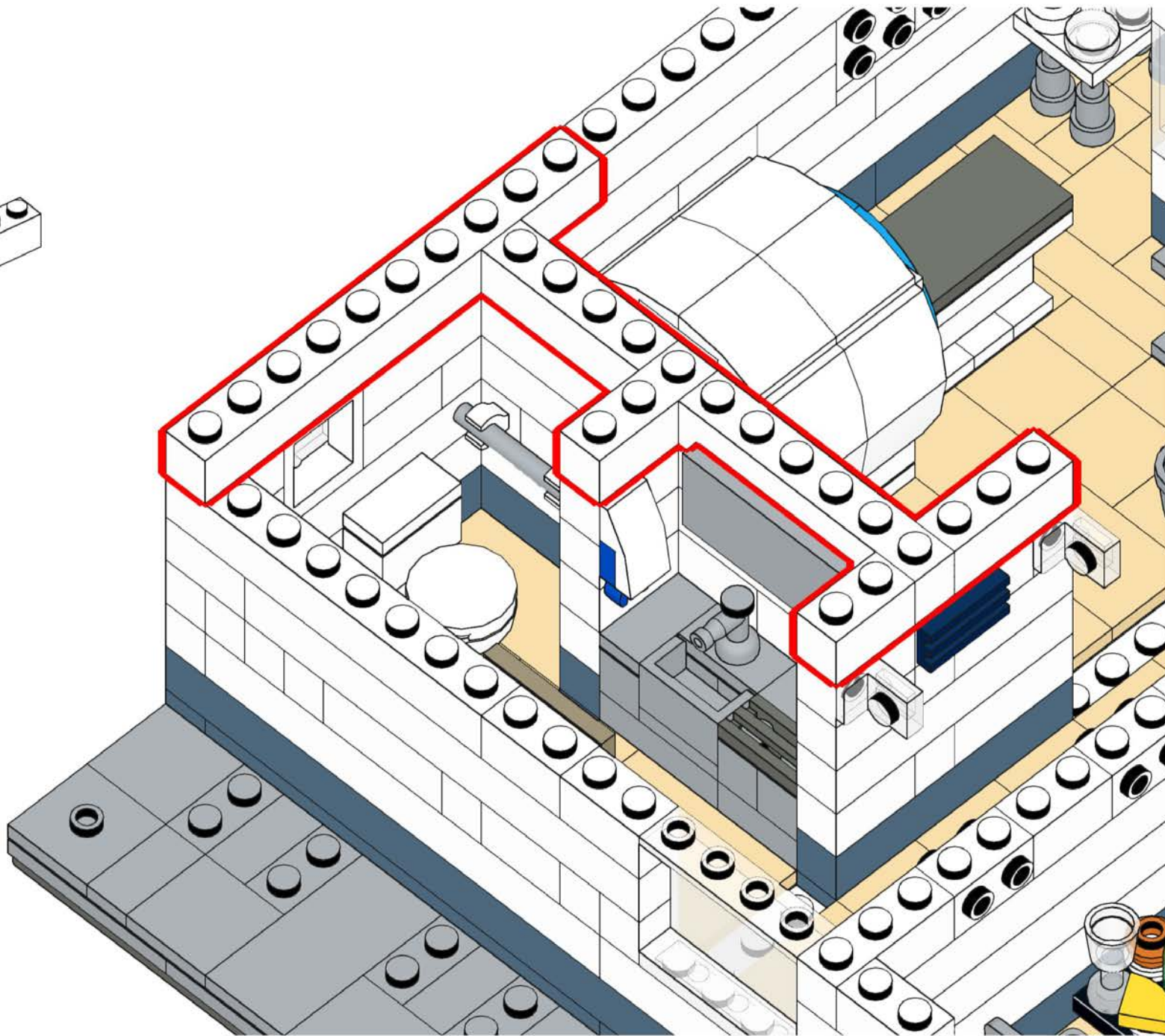
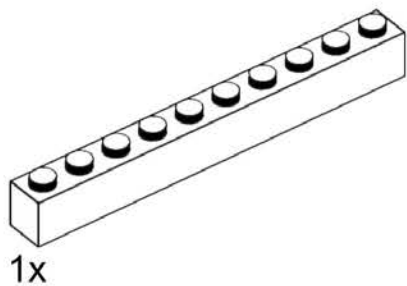
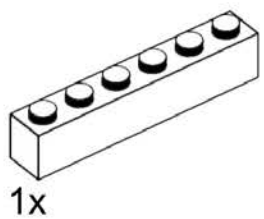
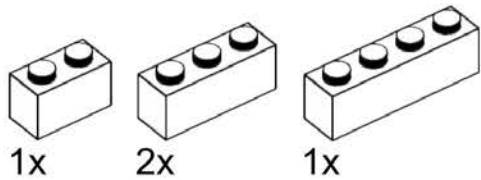

# 183

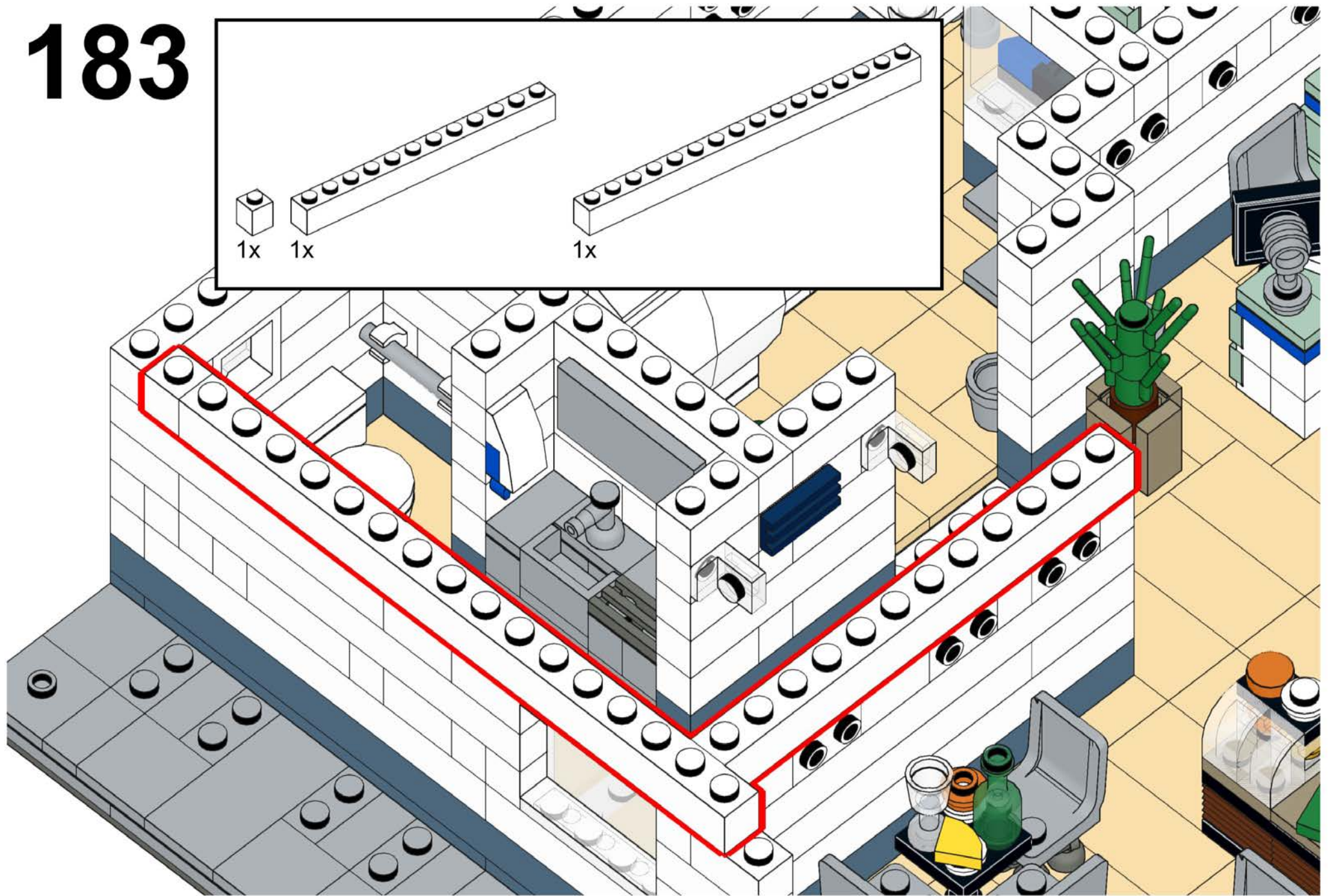
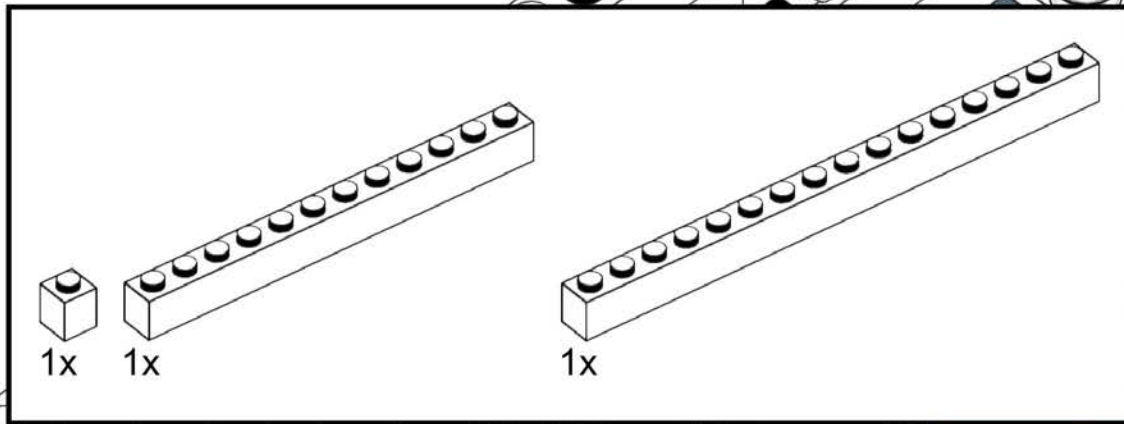

# 184

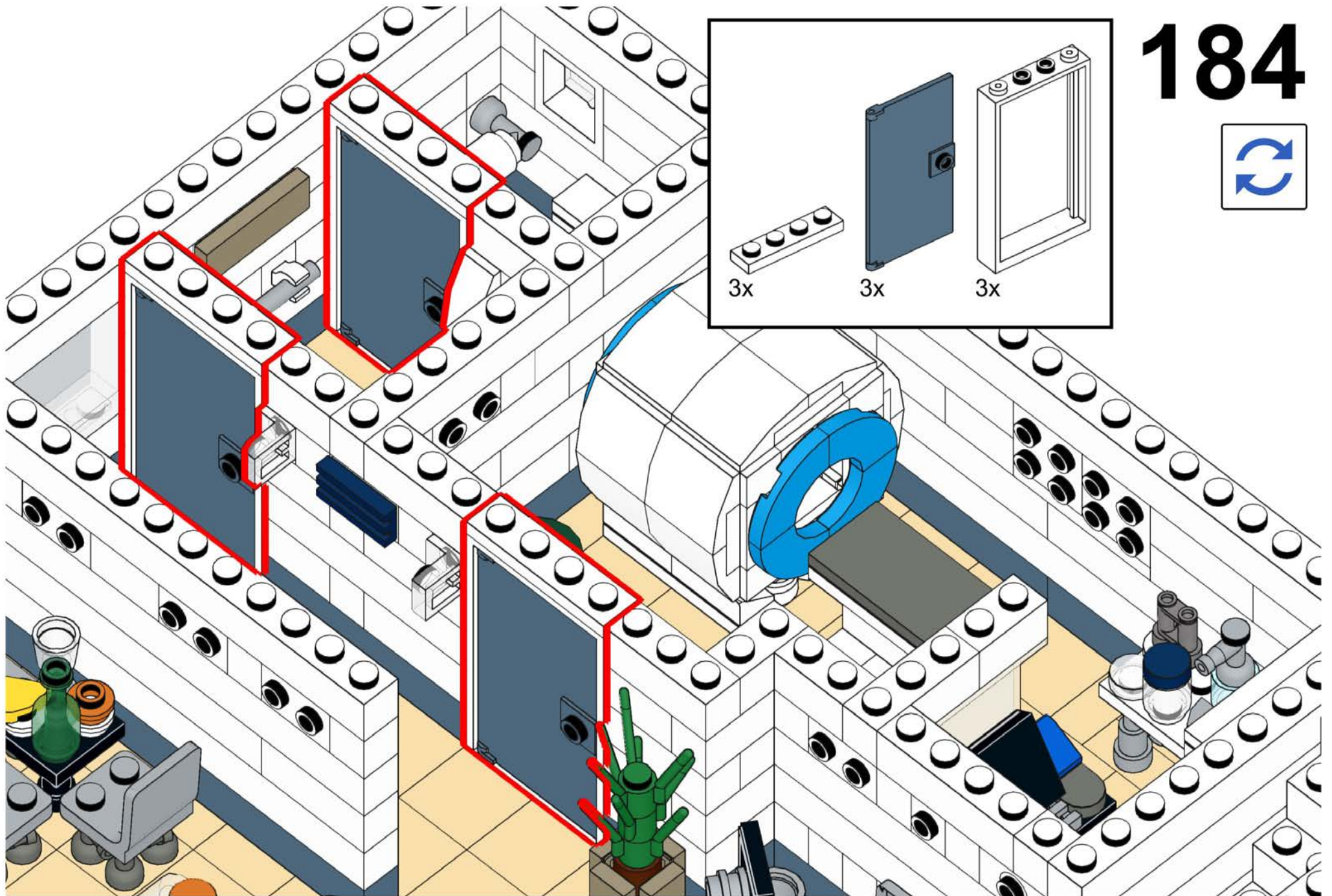

3x

3x

3x





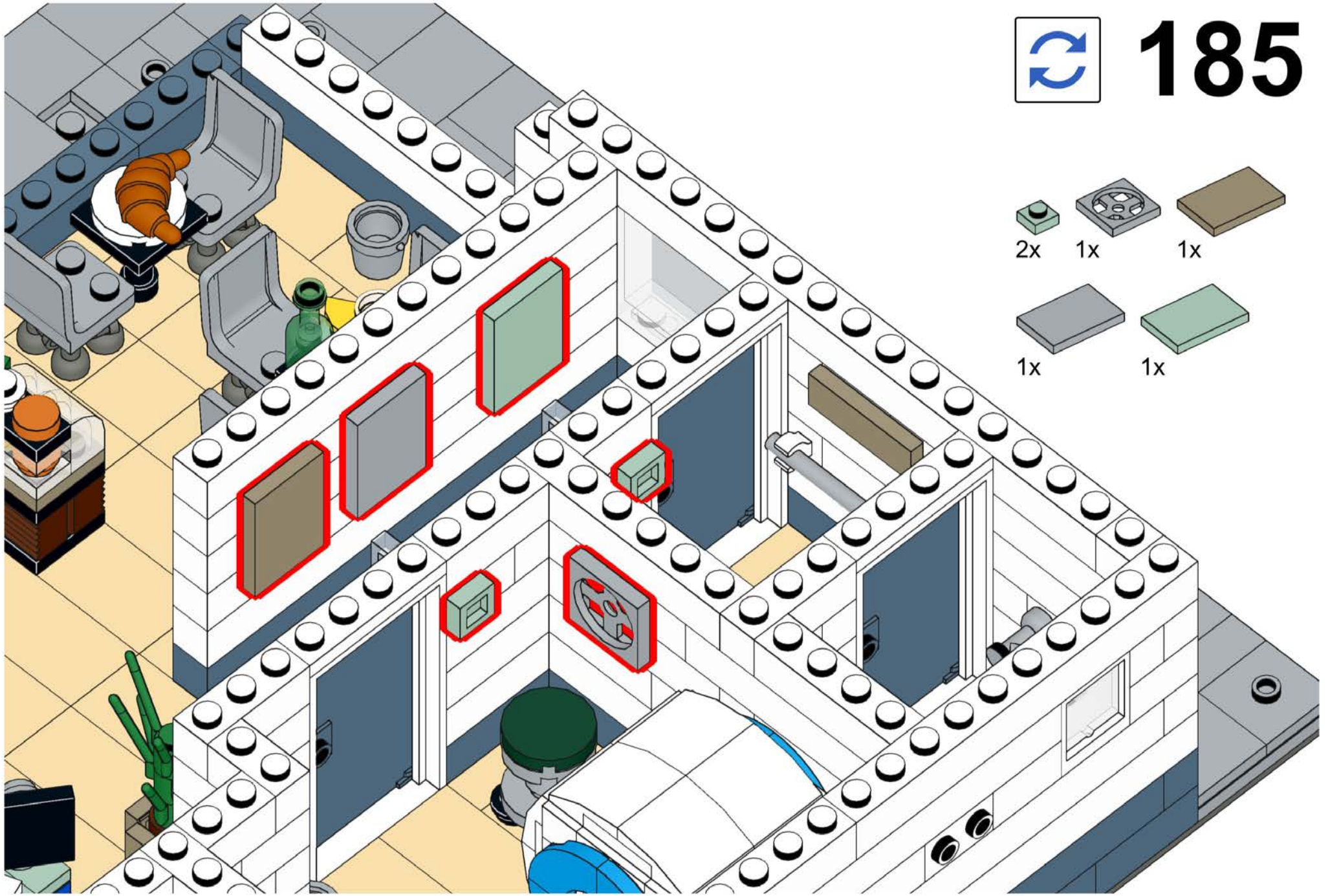



# 185



- 2x
- 1x
- 1x
- 1x
- 1x

# 186

					
1x	1x	1x	1x	1x	1x





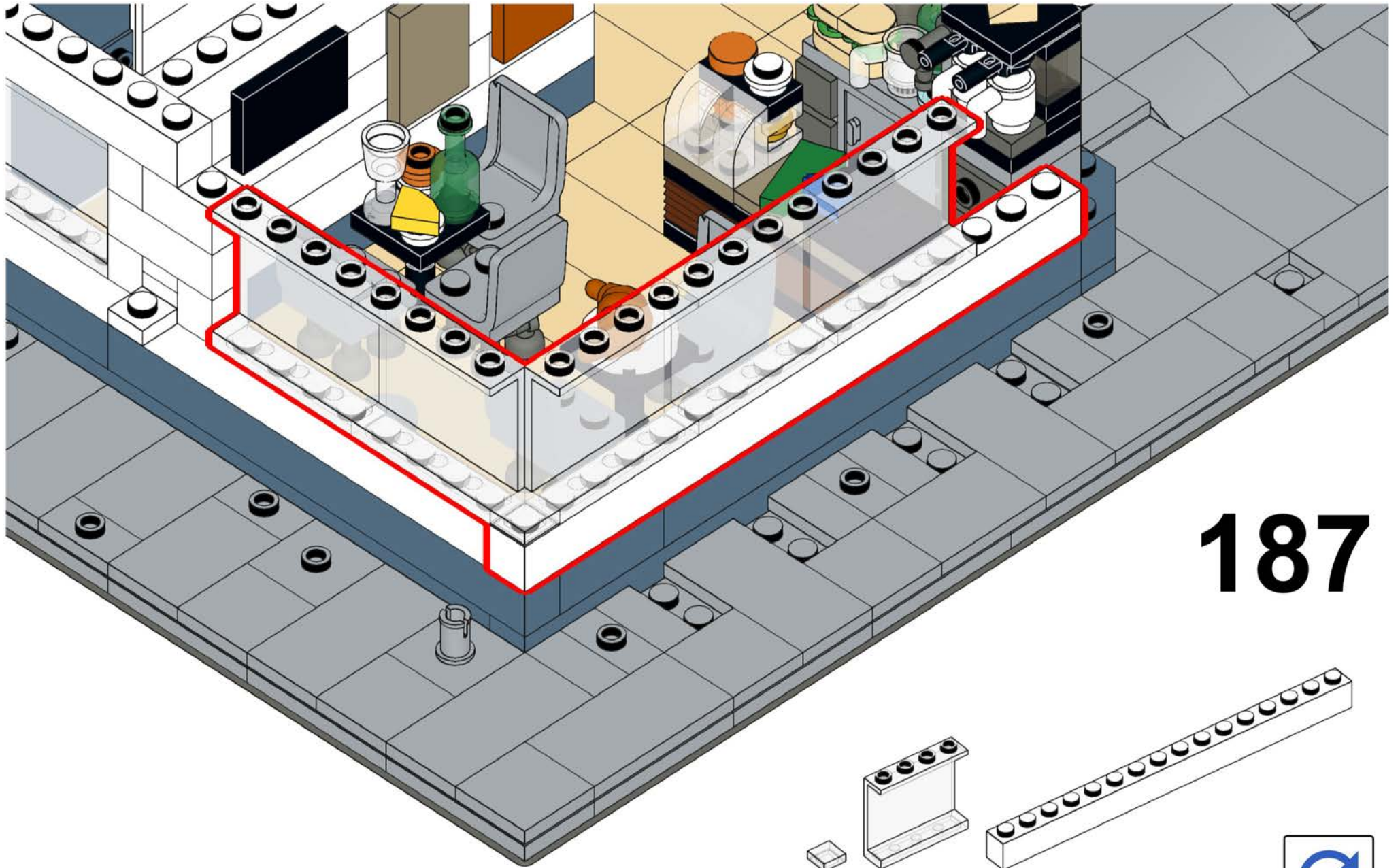

187

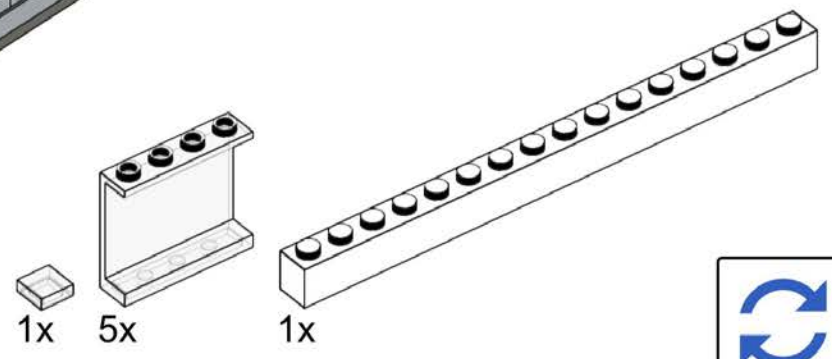

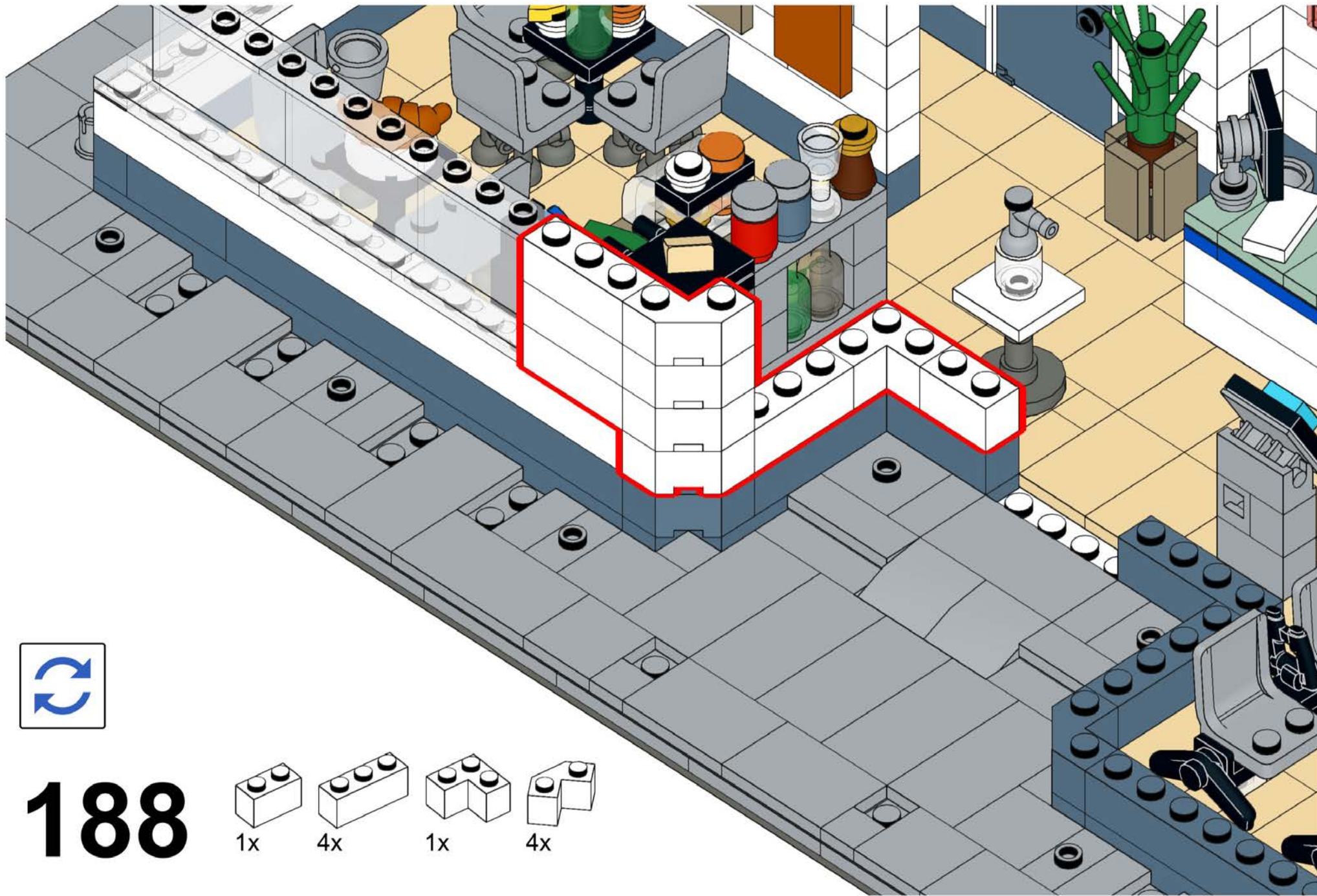

188

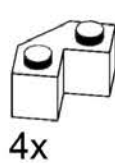
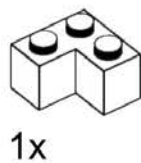
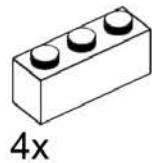
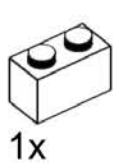

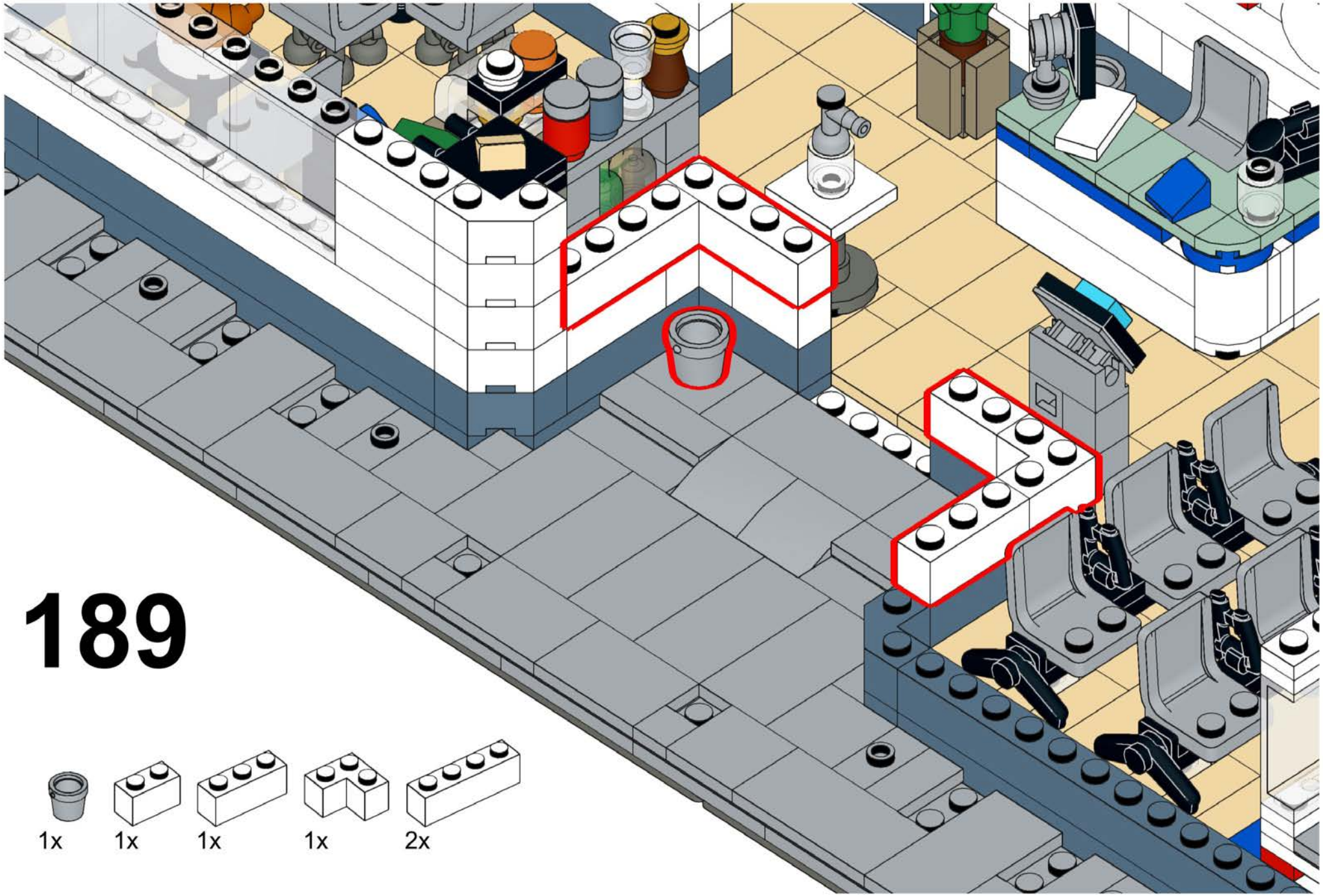

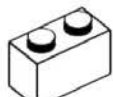
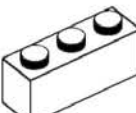
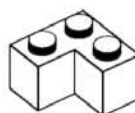
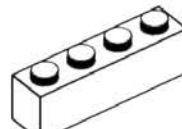

# 189

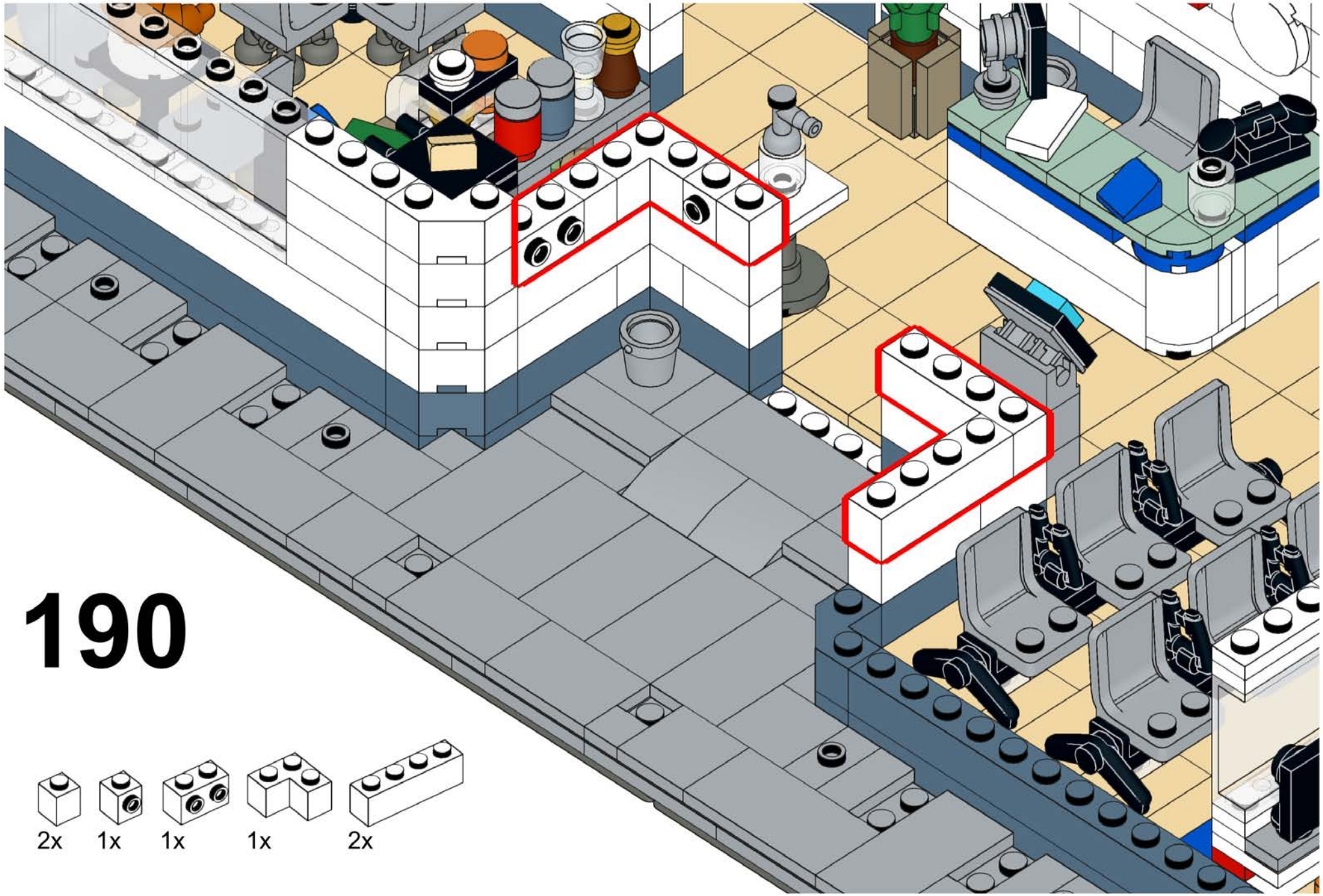
- 1x 
- 1x 
- 1x 
- 1x 
- 2x 

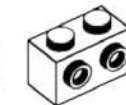
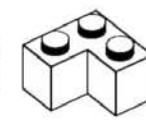
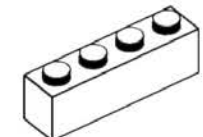

# 190

- 2x 
- 1x 
- 1x 
- 1x 
- 2x 

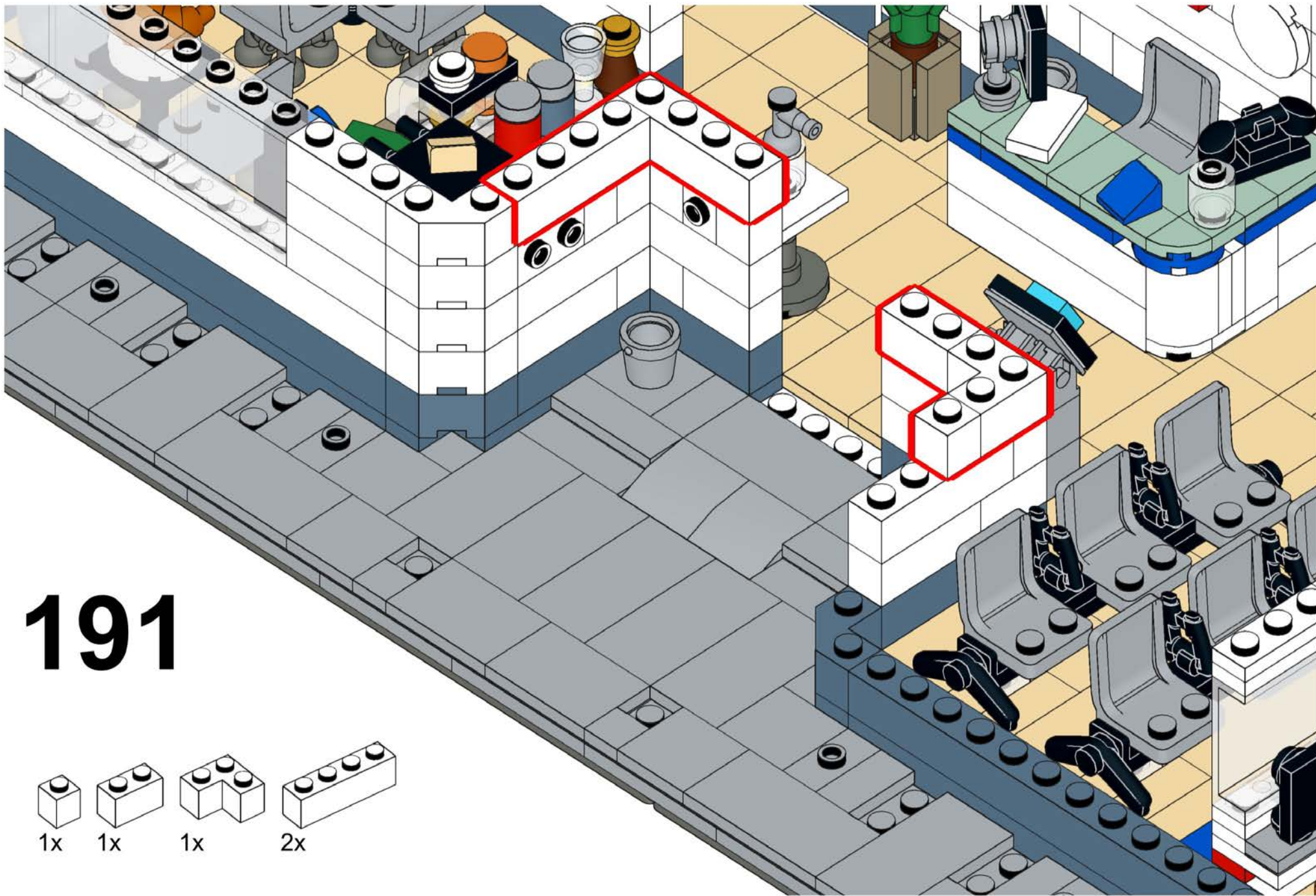

191

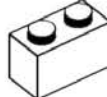
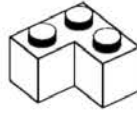
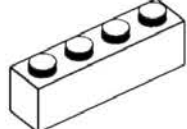
- 1x 
- 1x 
- 1x 
- 2x 



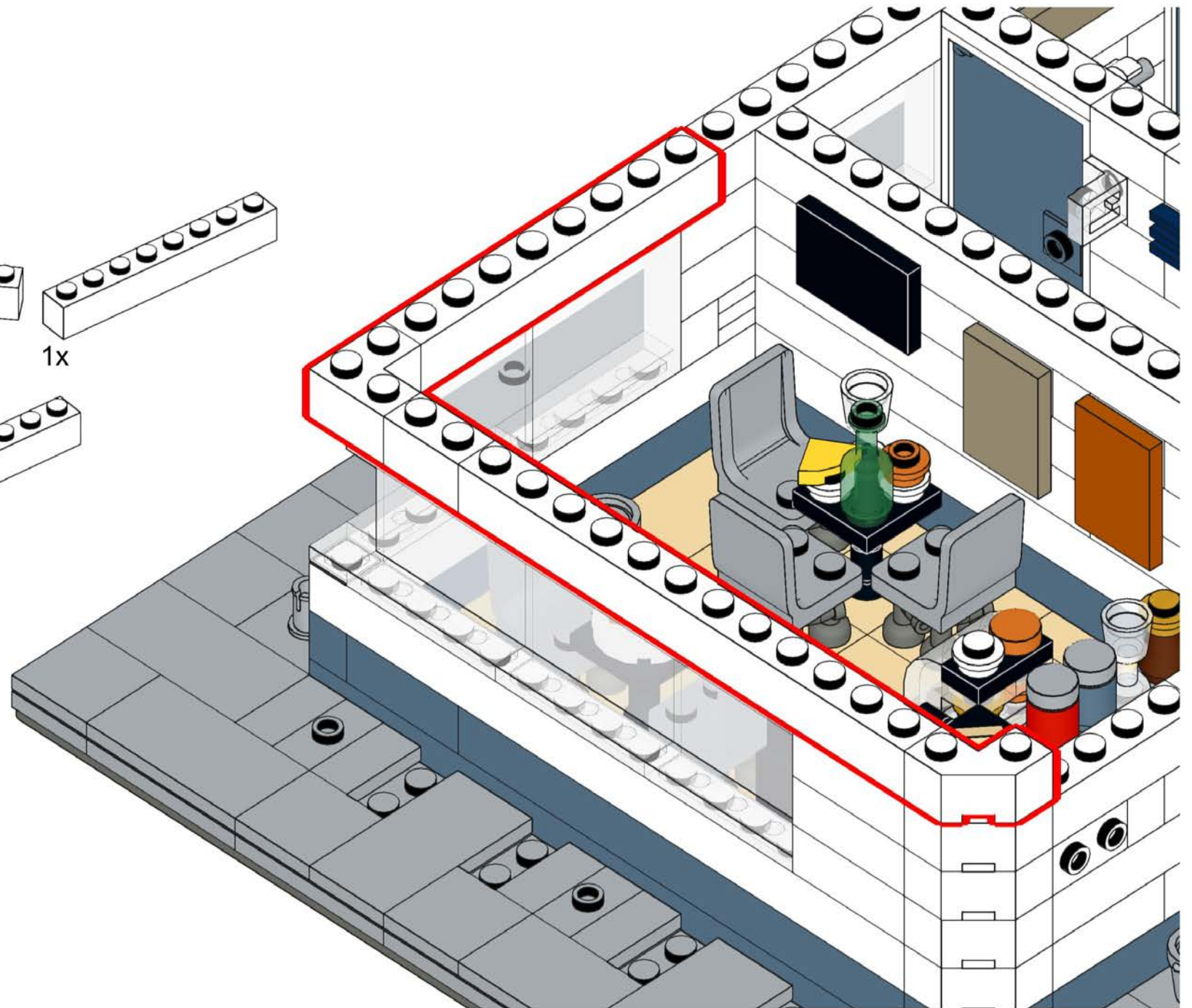
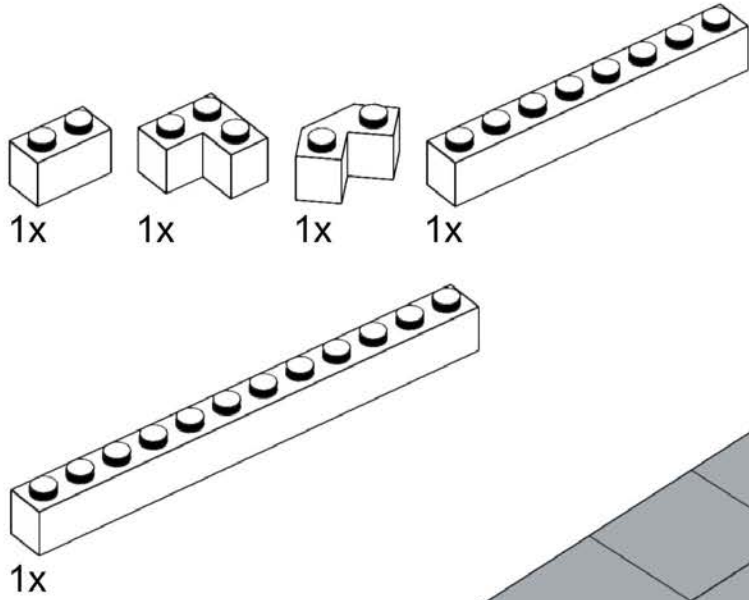

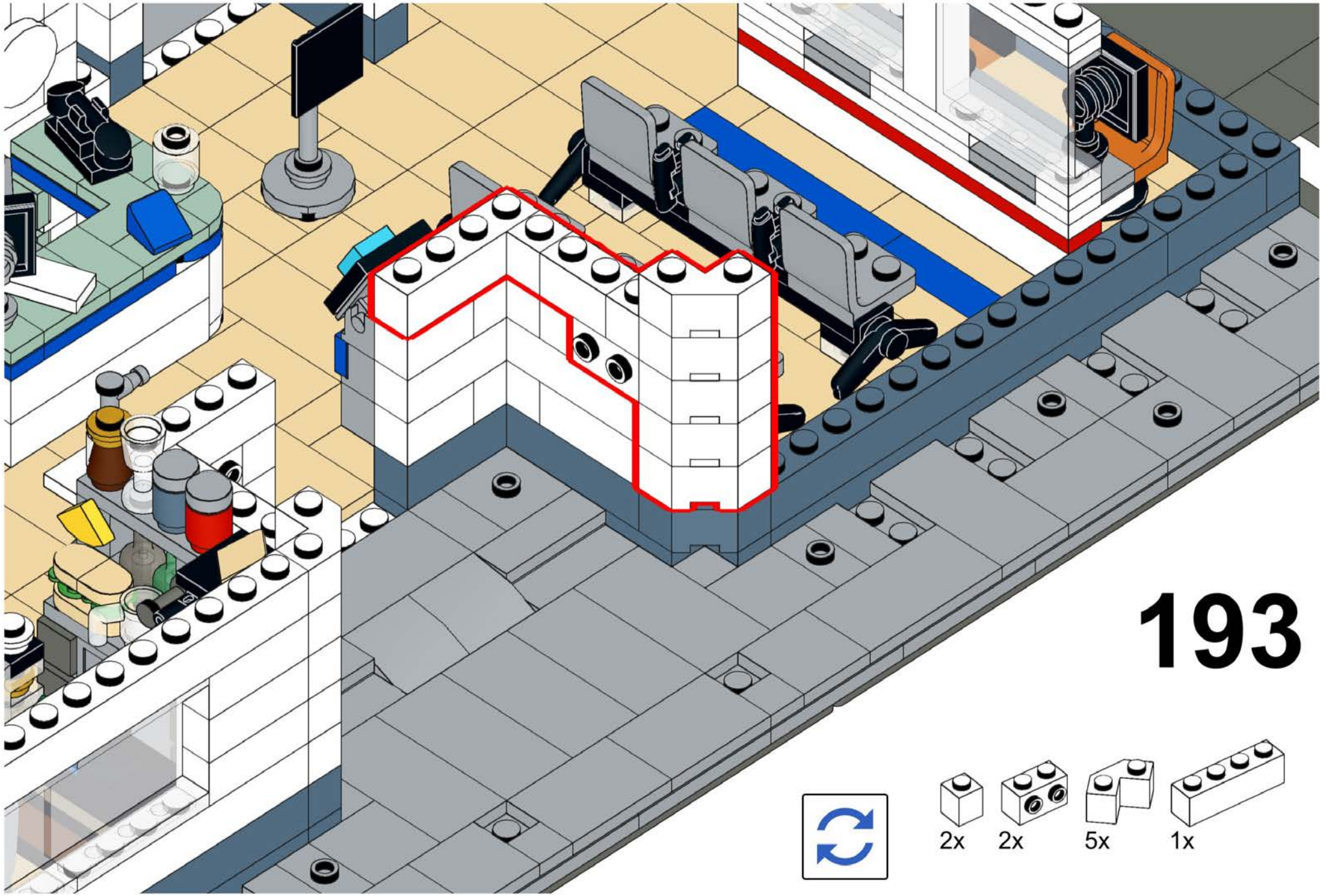
# 192





193

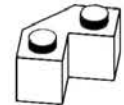

- 2x 
- 2x 
- 5x 
- 1x 

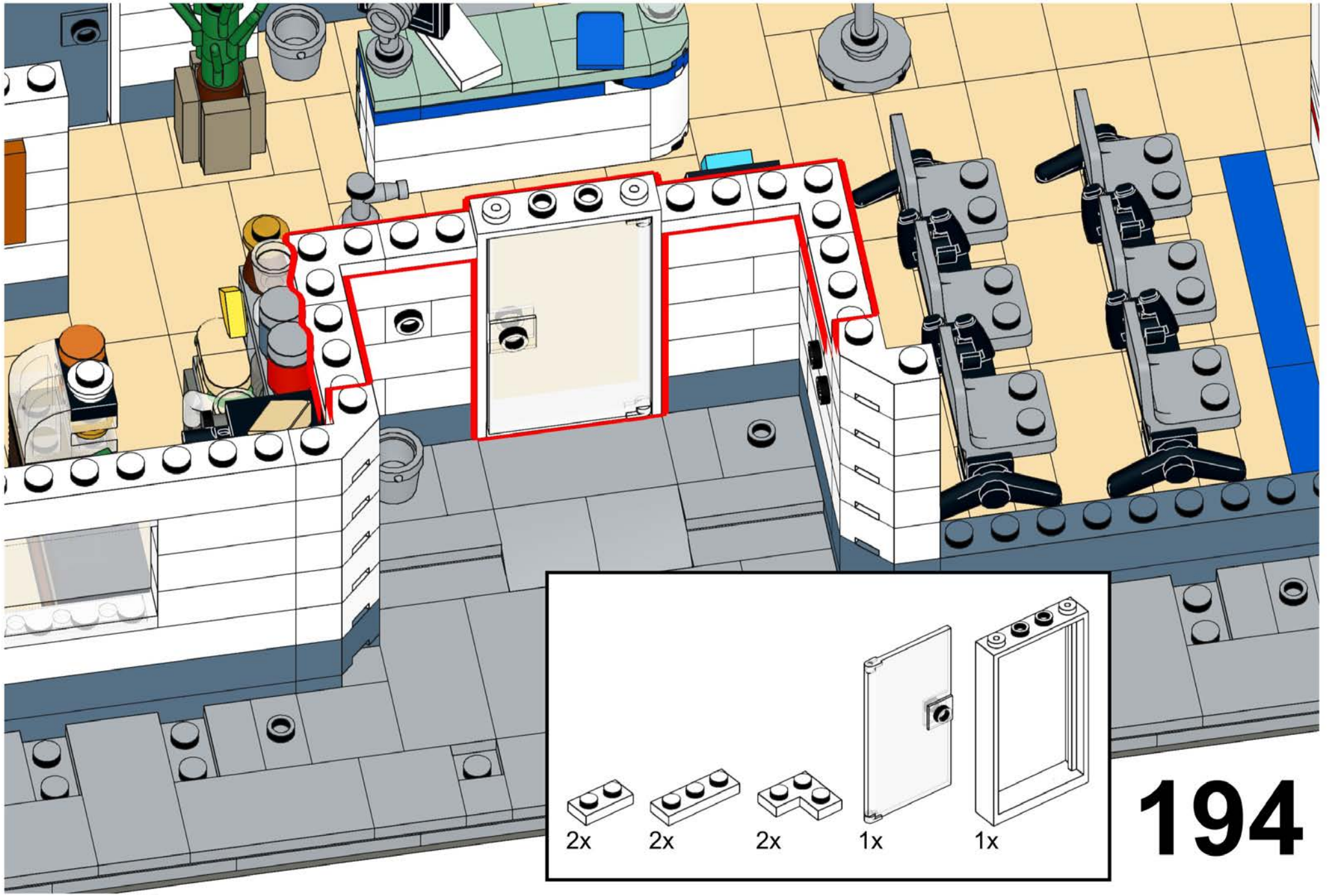

2x   2x   2x   1x   1x

A list of parts for step 194. From left to right: a 2x1 brick (labeled 2x), a 2x2 brick (labeled 2x), a 2x3 L-shaped brick (labeled 2x), a white door (labeled 1x), and a white frame (labeled 1x).

194



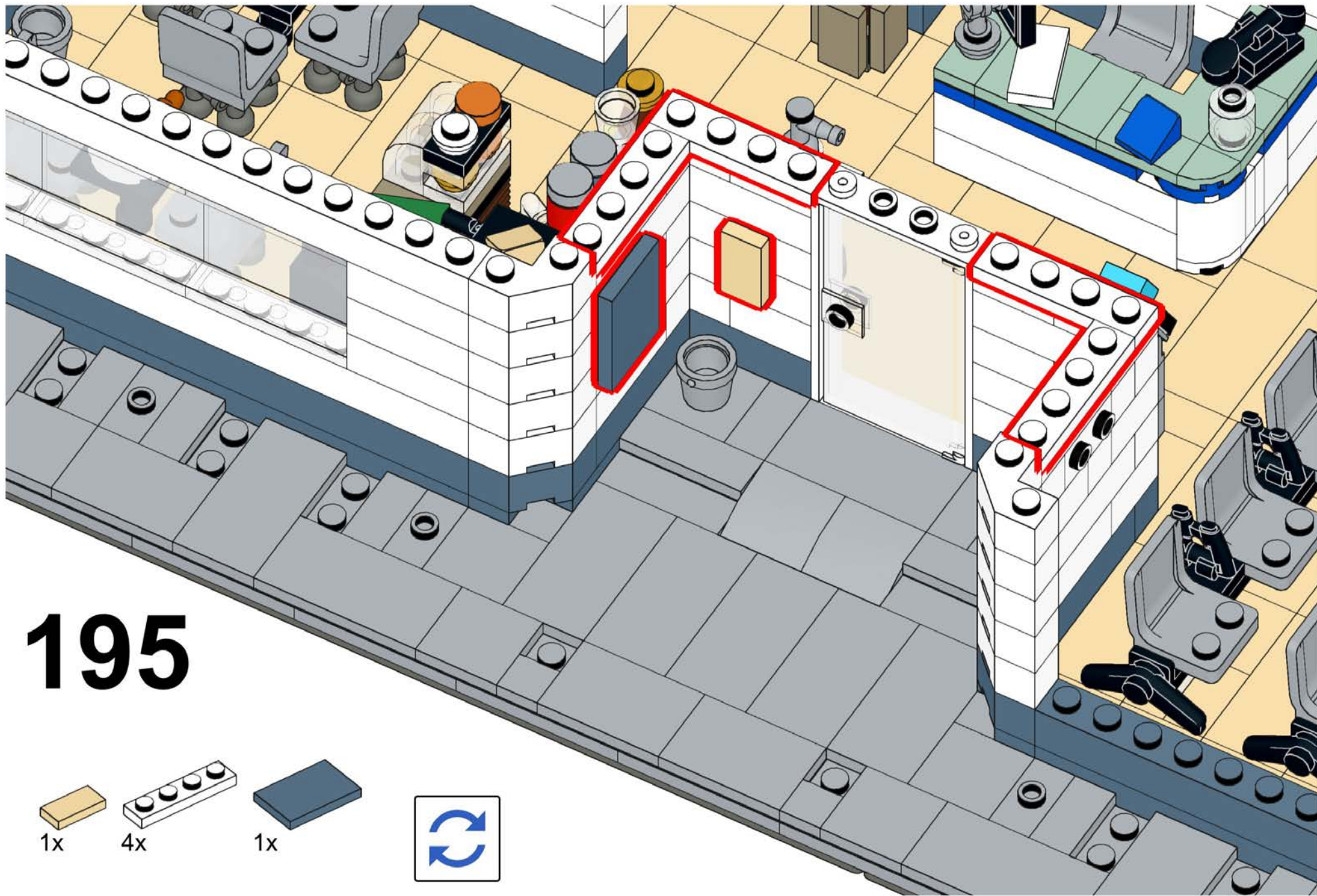

# 195



1x



4x



1x



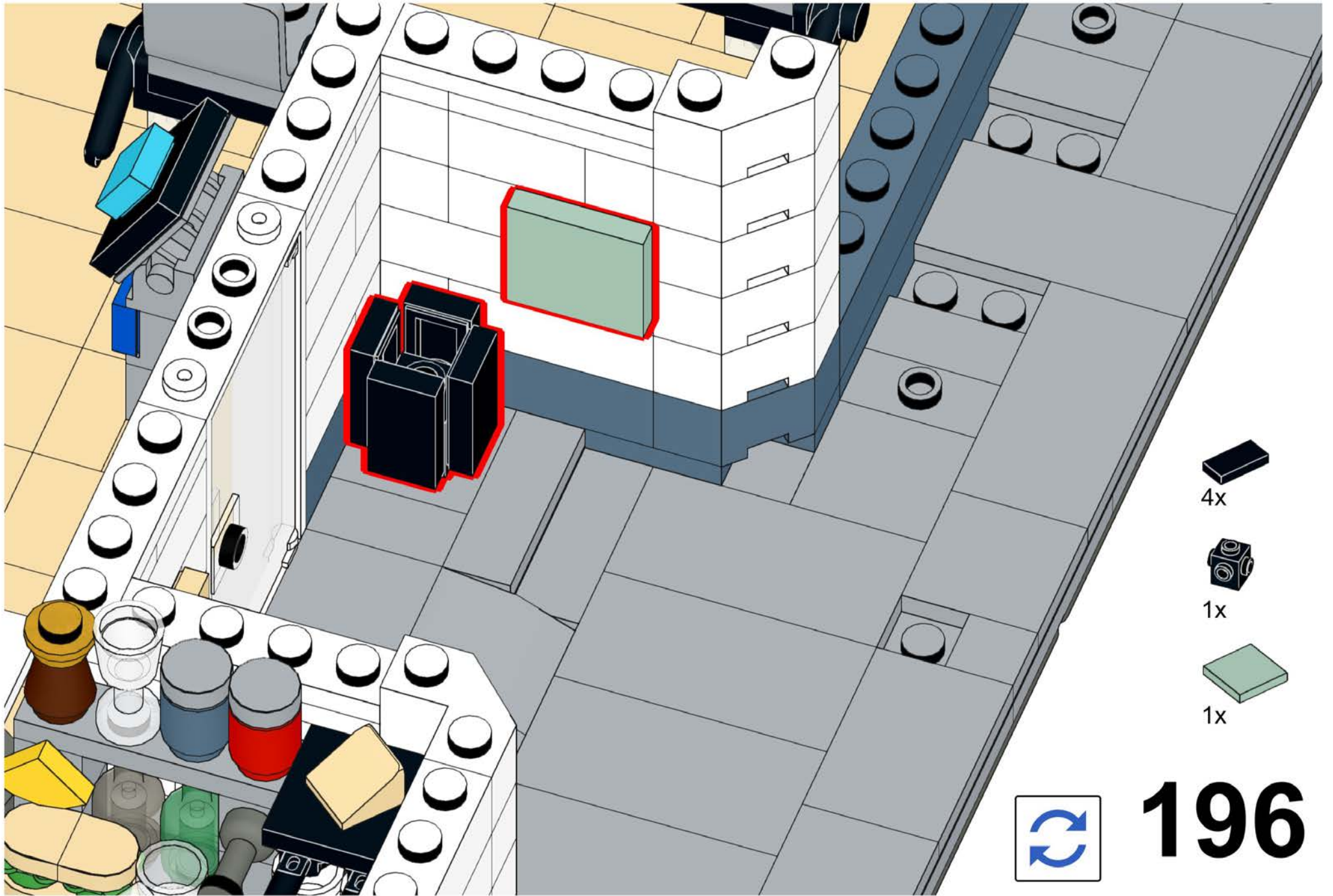

4x



1x



1x



# 196

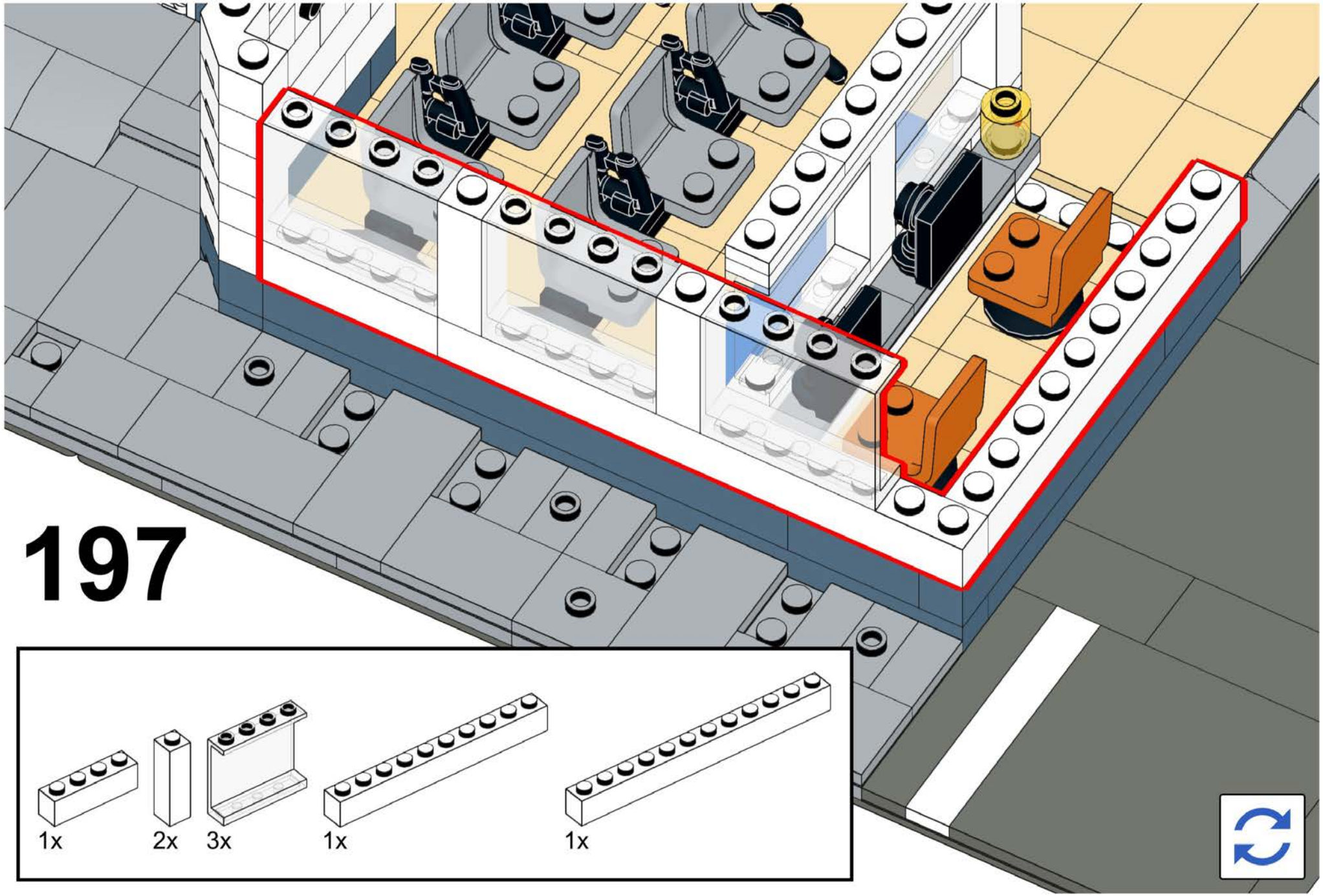

197

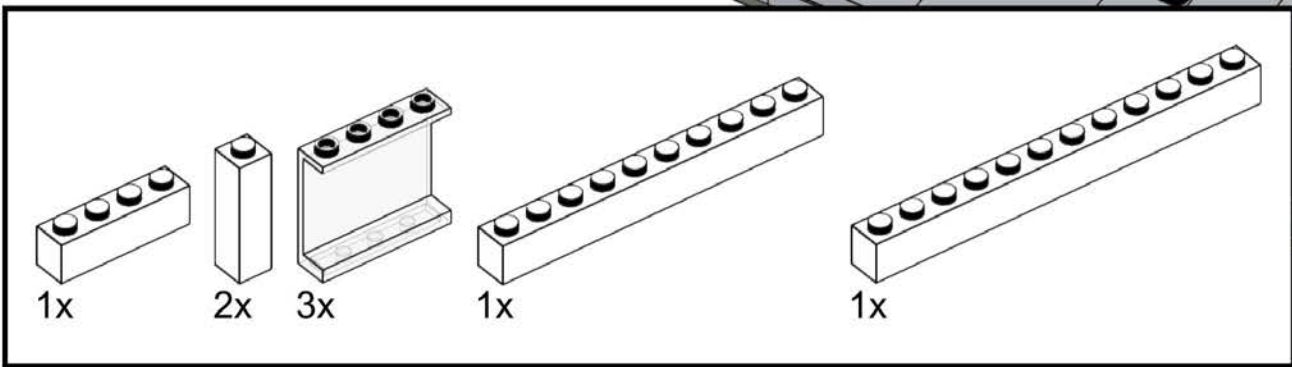

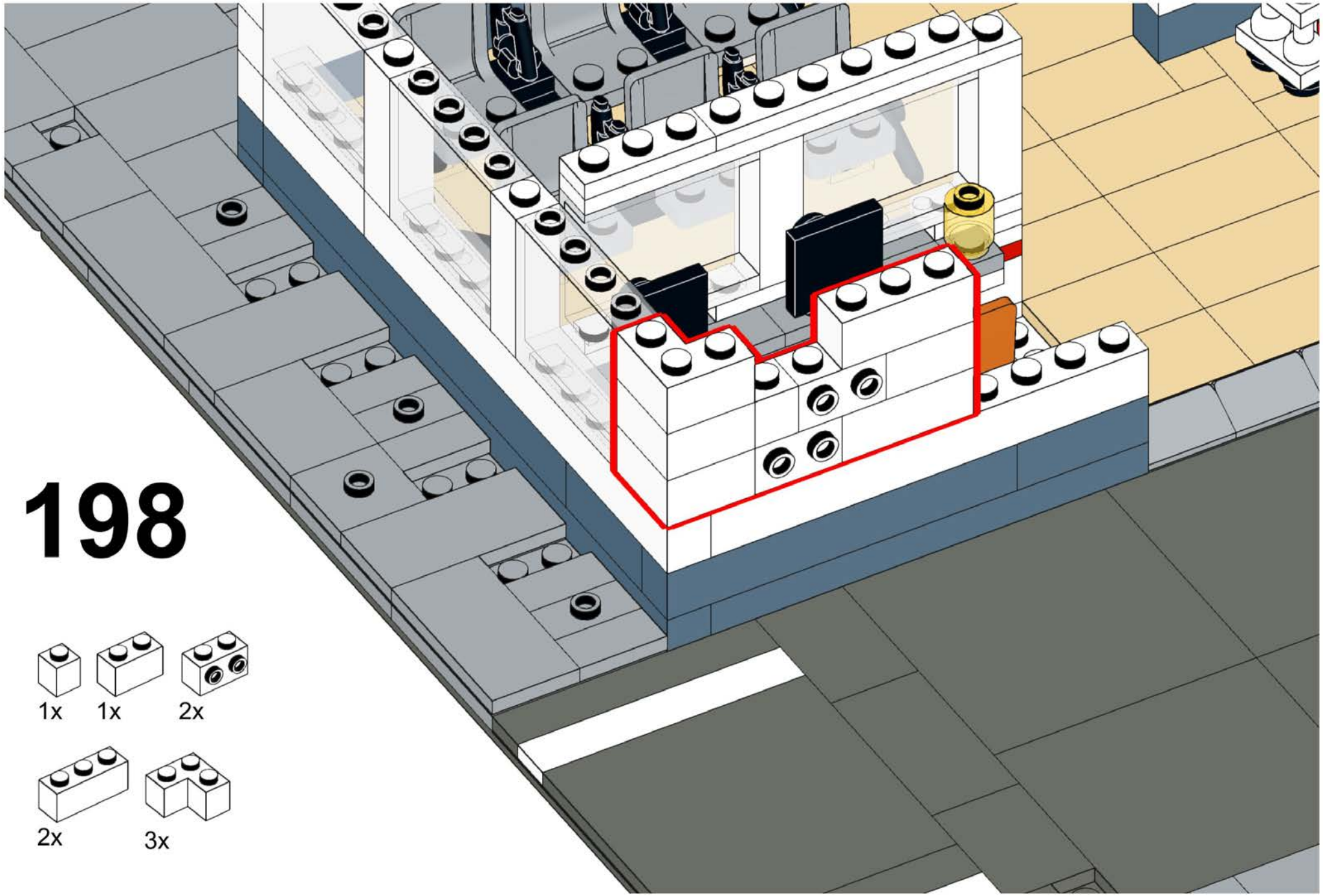

198

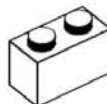
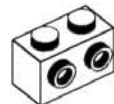
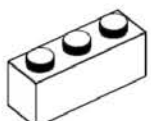
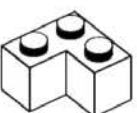
- 1x 
- 1x 
- 2x 
- 2x 
- 3x 

# 199

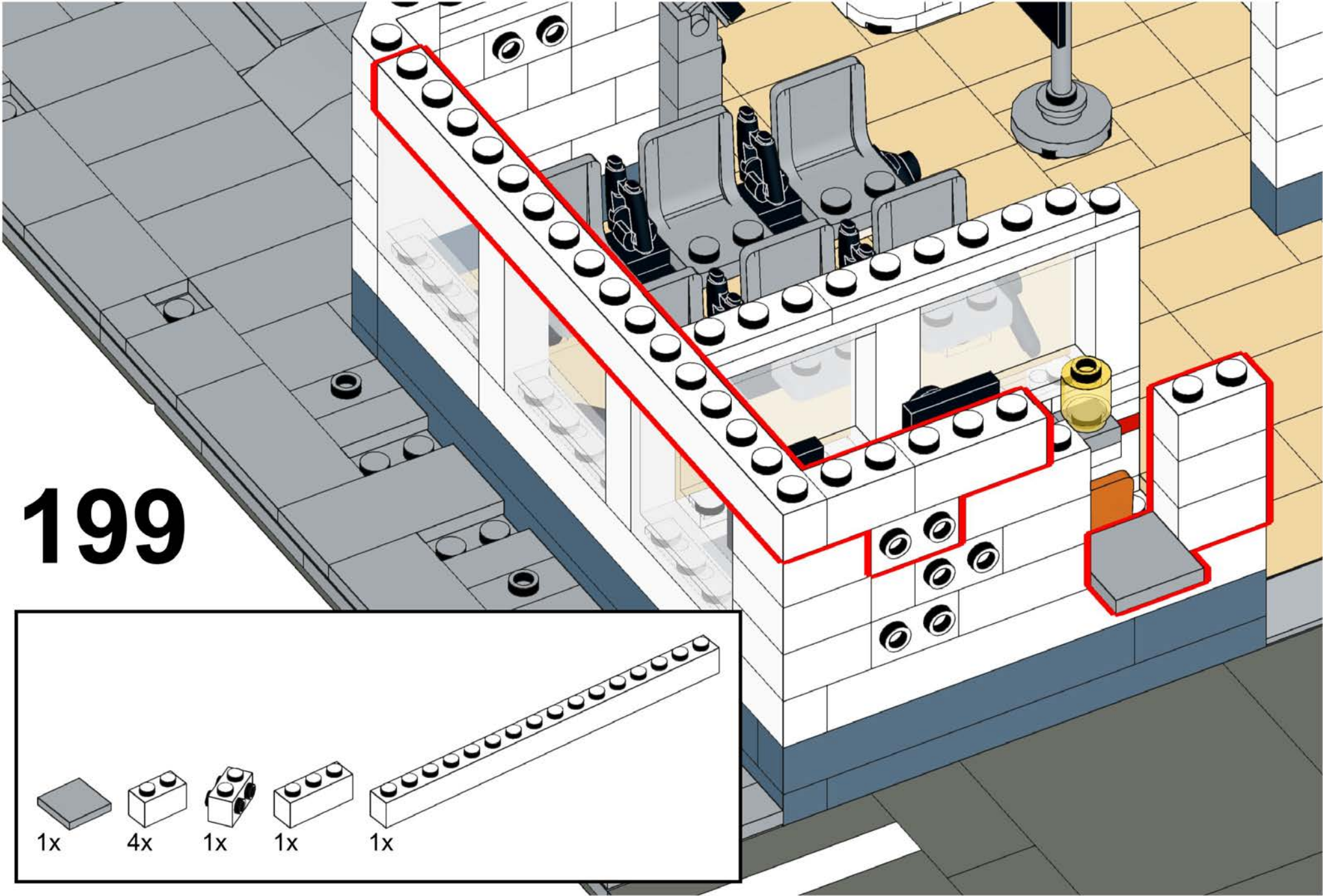
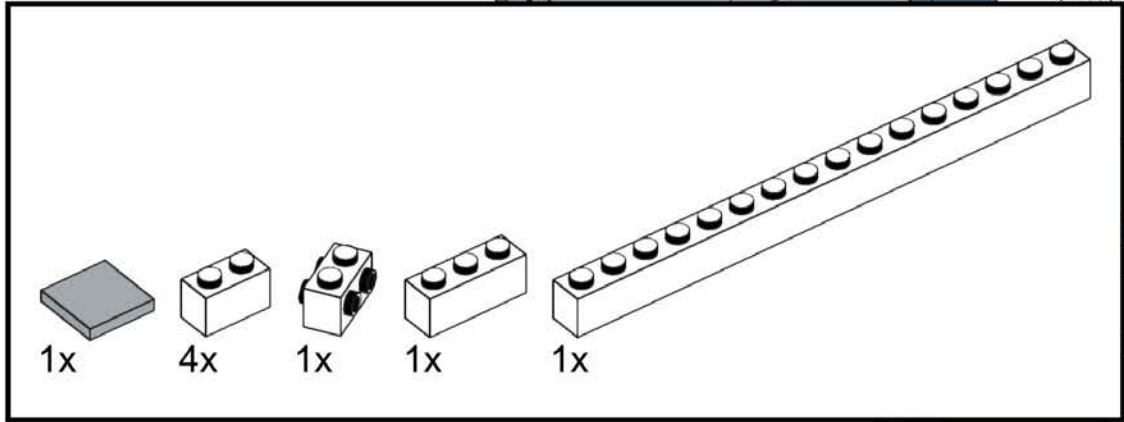

# 200

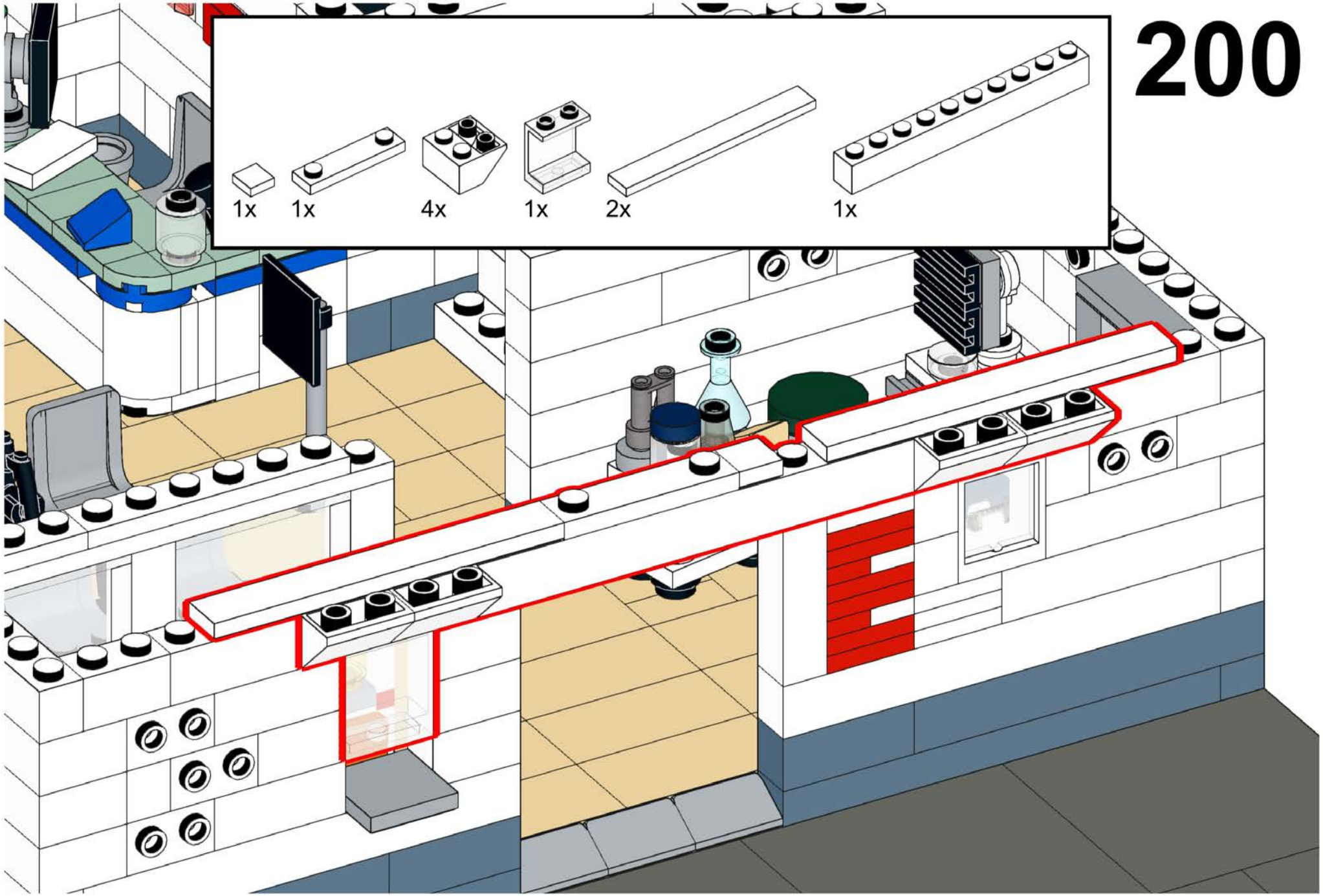

# 201

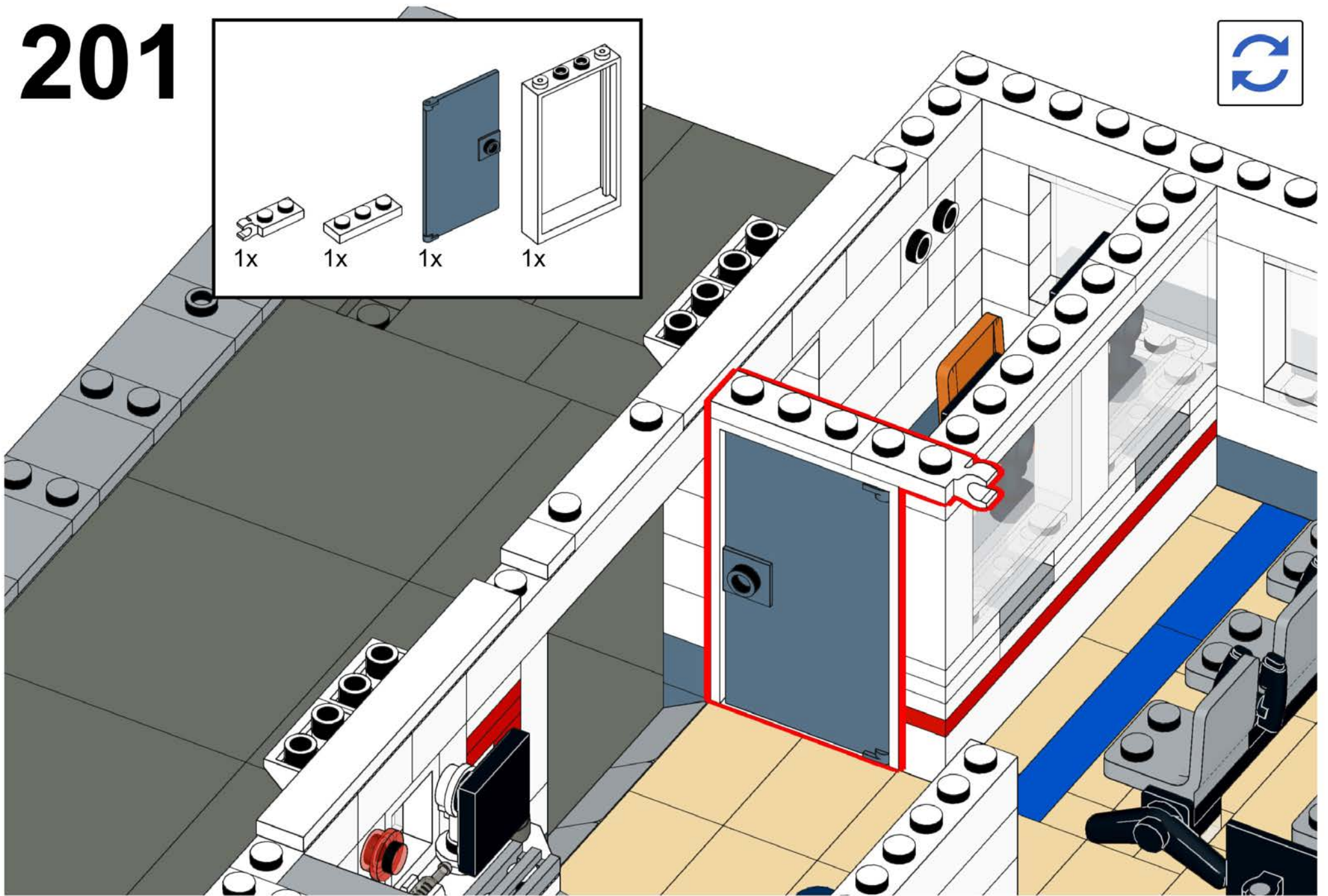
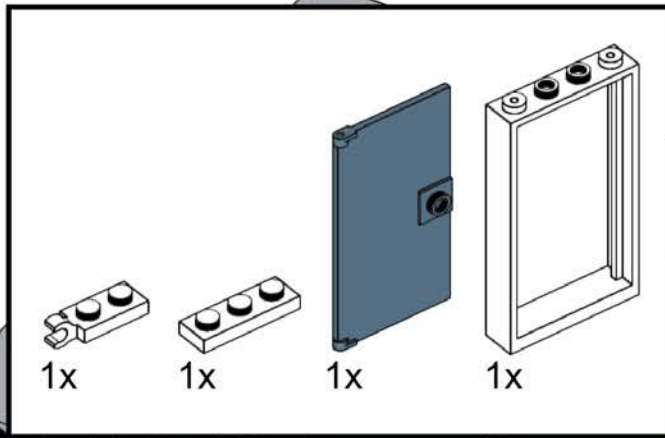

# 202

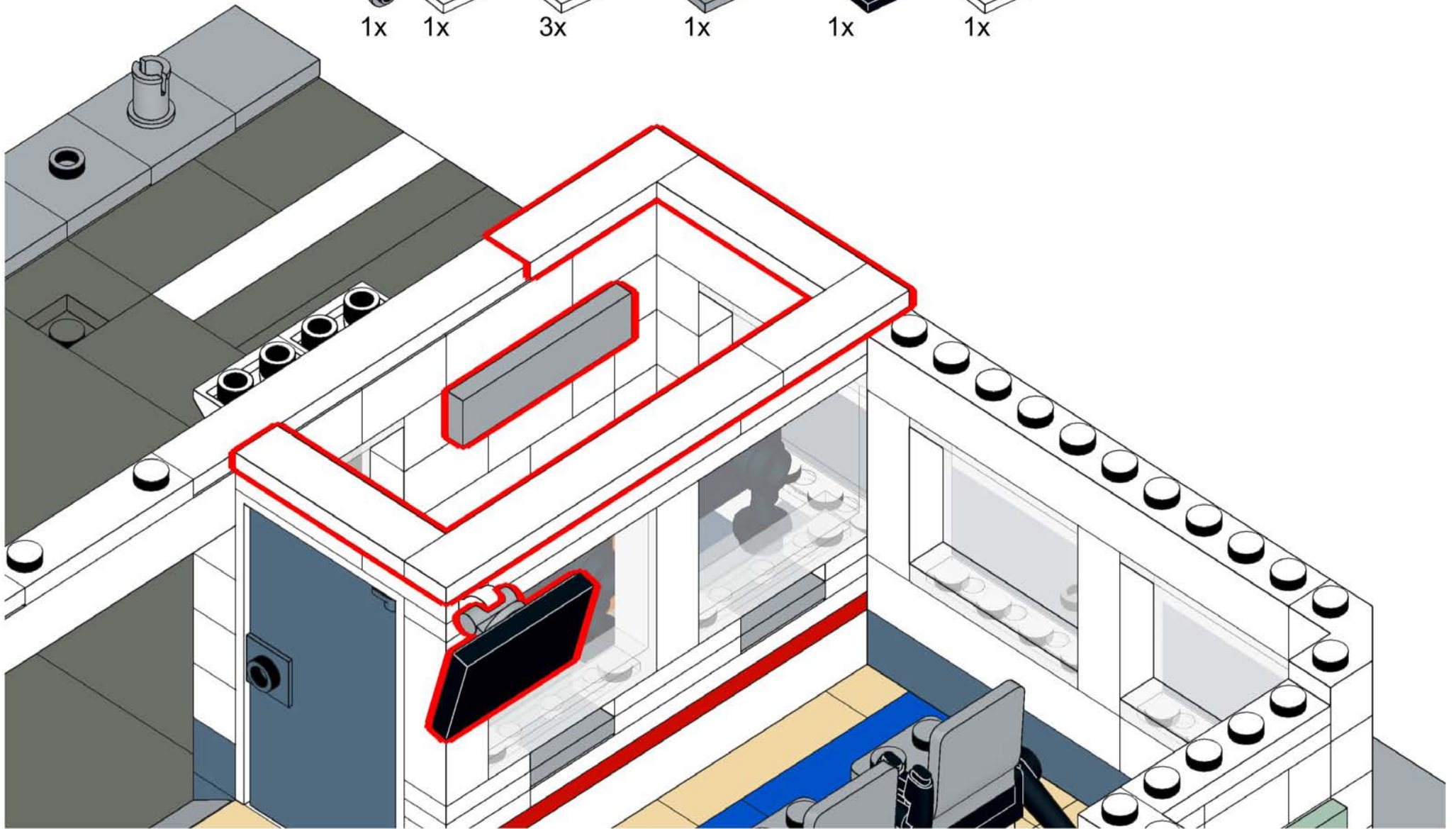
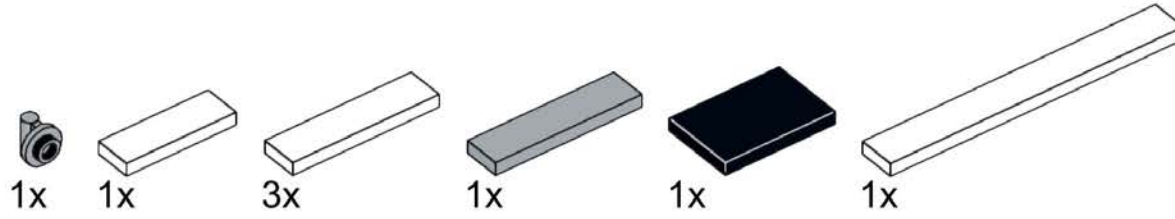



# 203

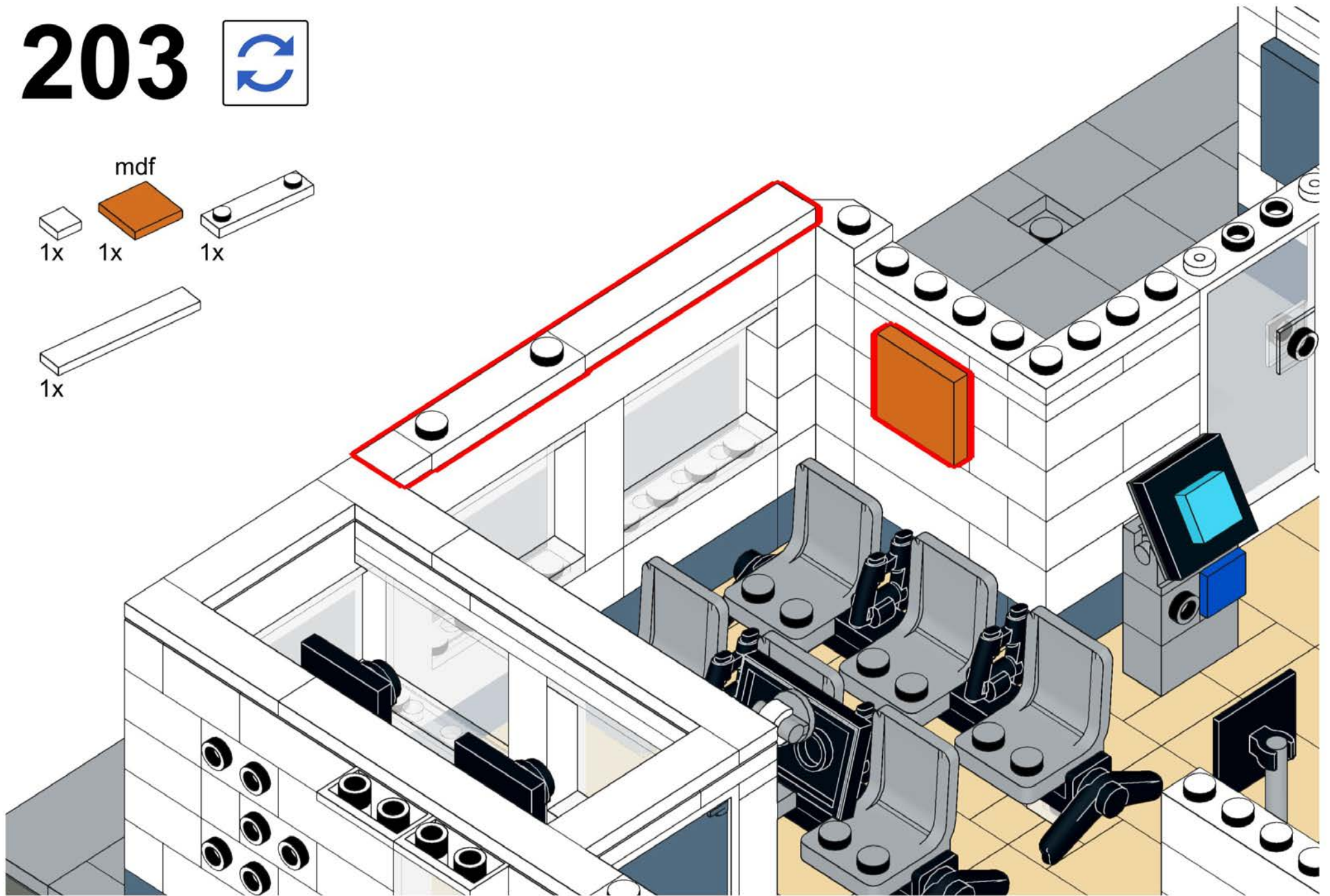
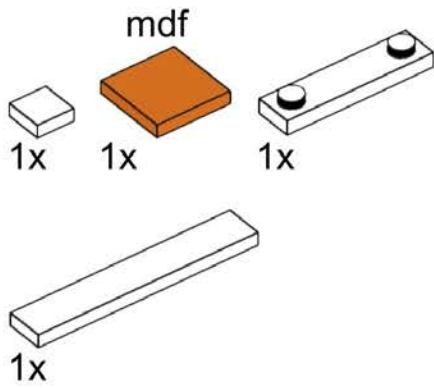

# 204

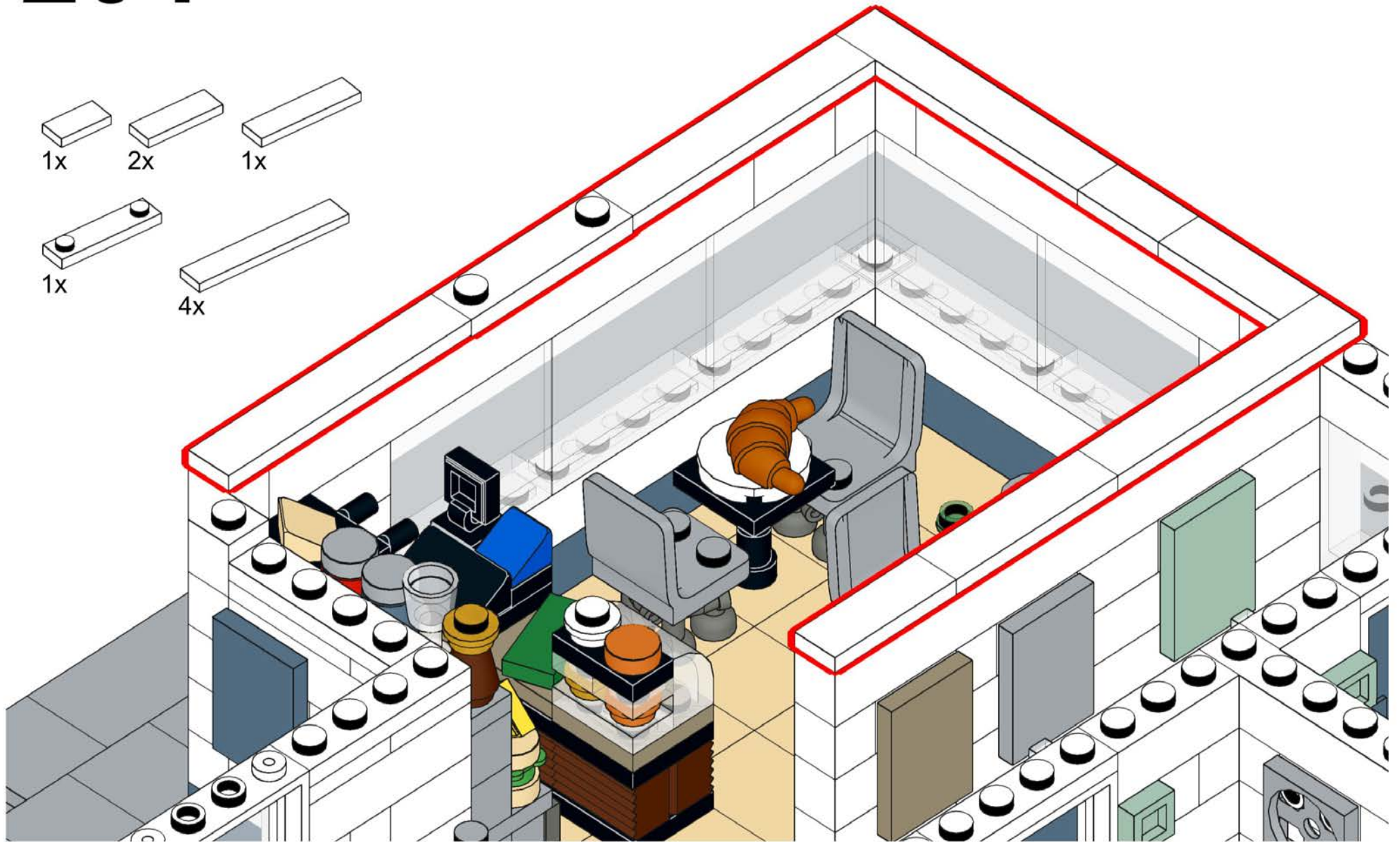
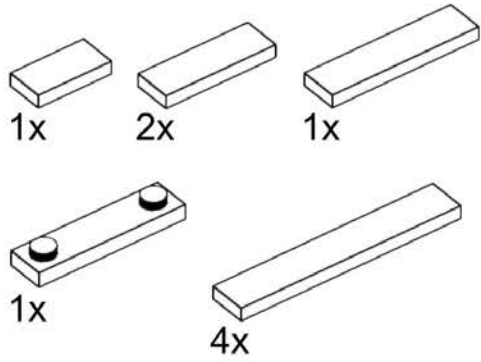

# 205

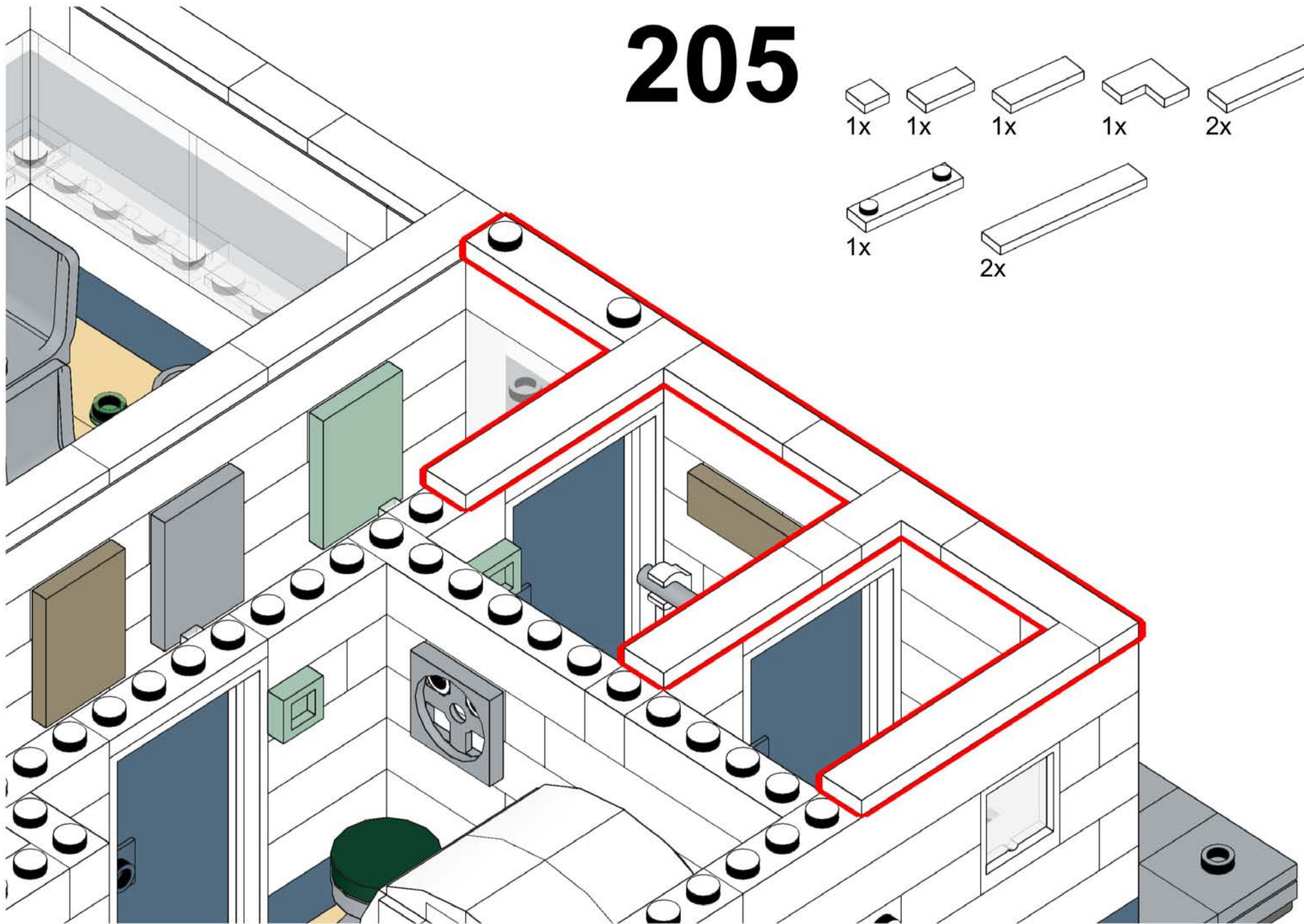
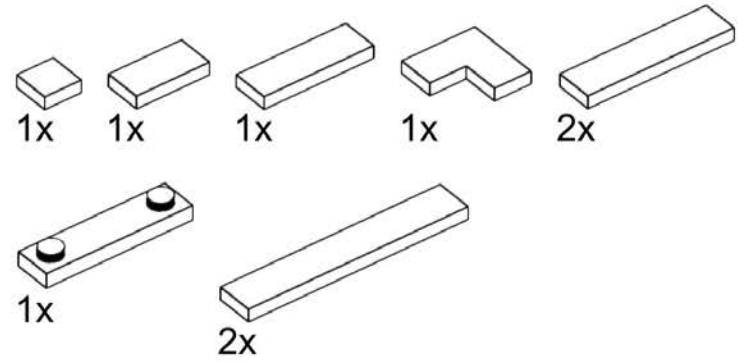

# 206

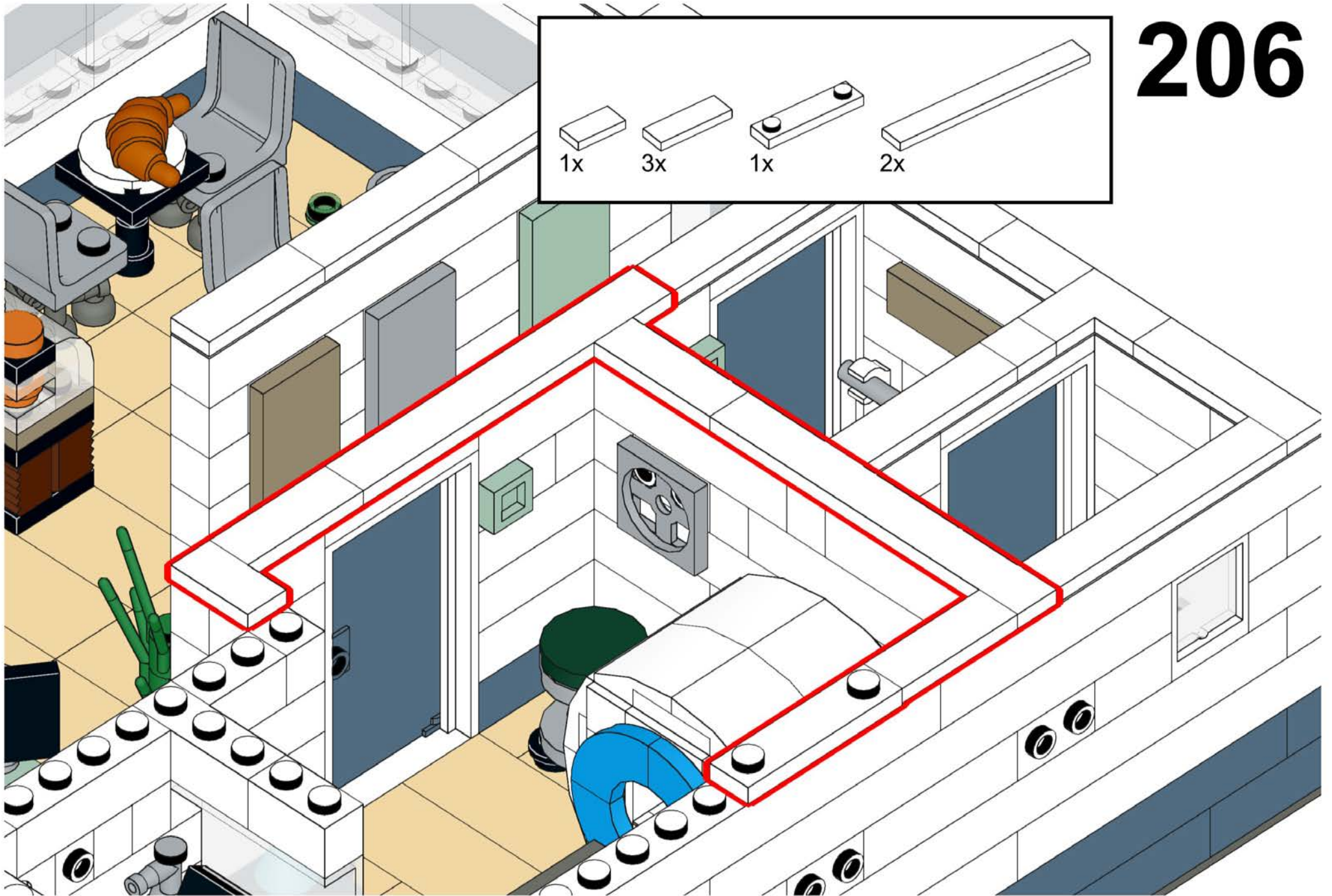
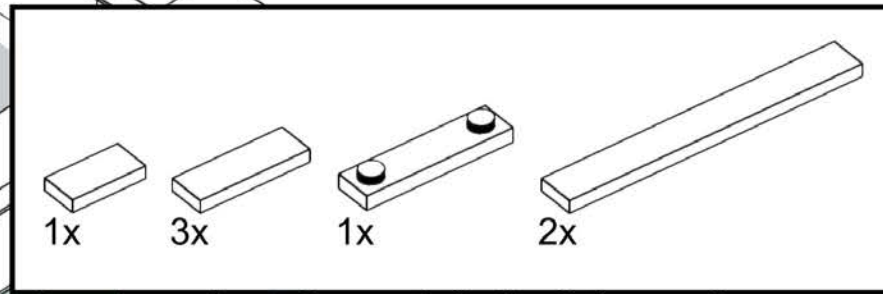

# 207

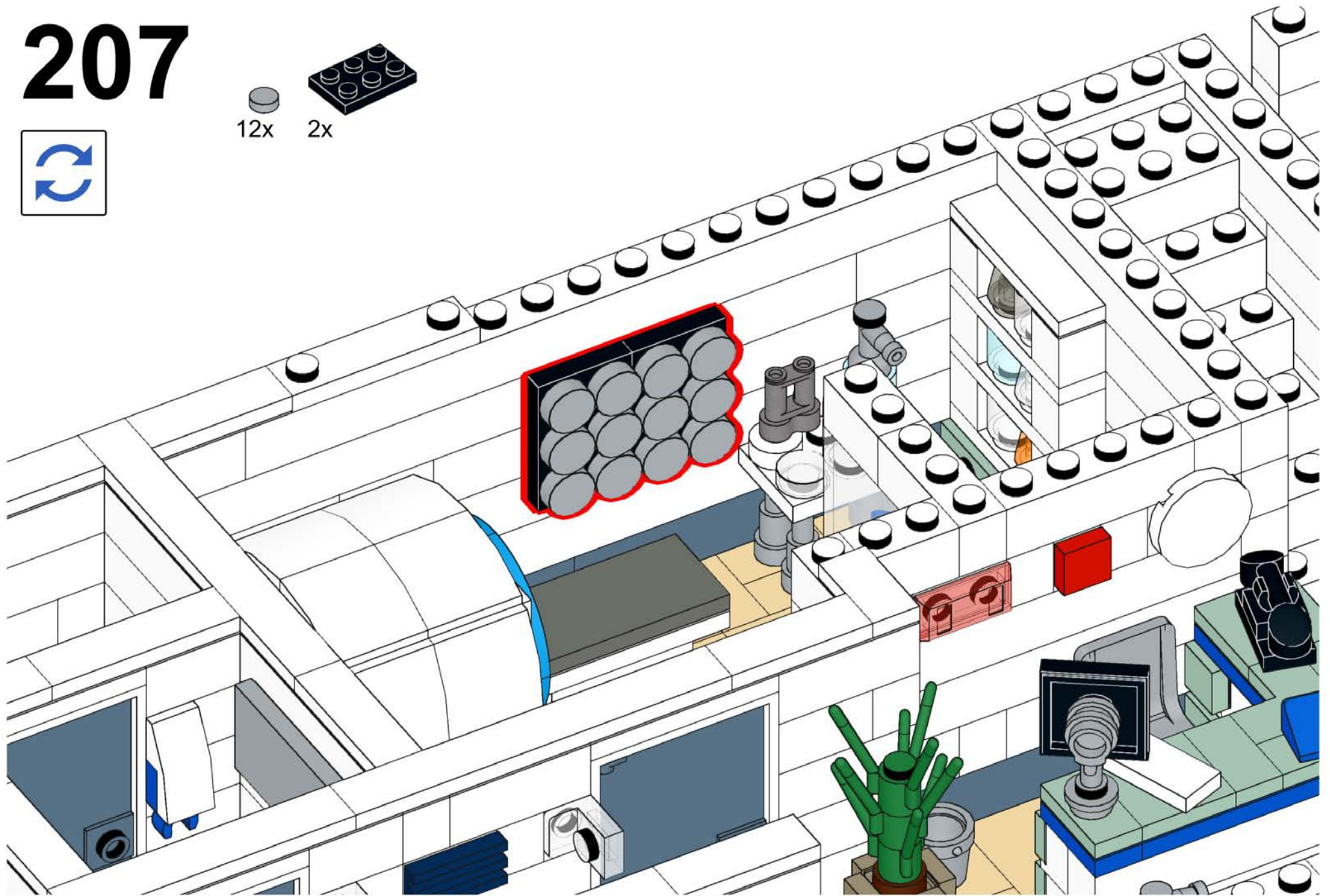
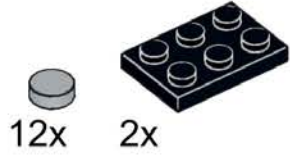

# 208

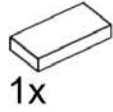

1x

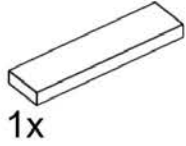

1x

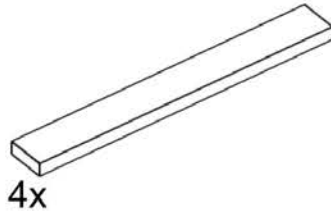

4x

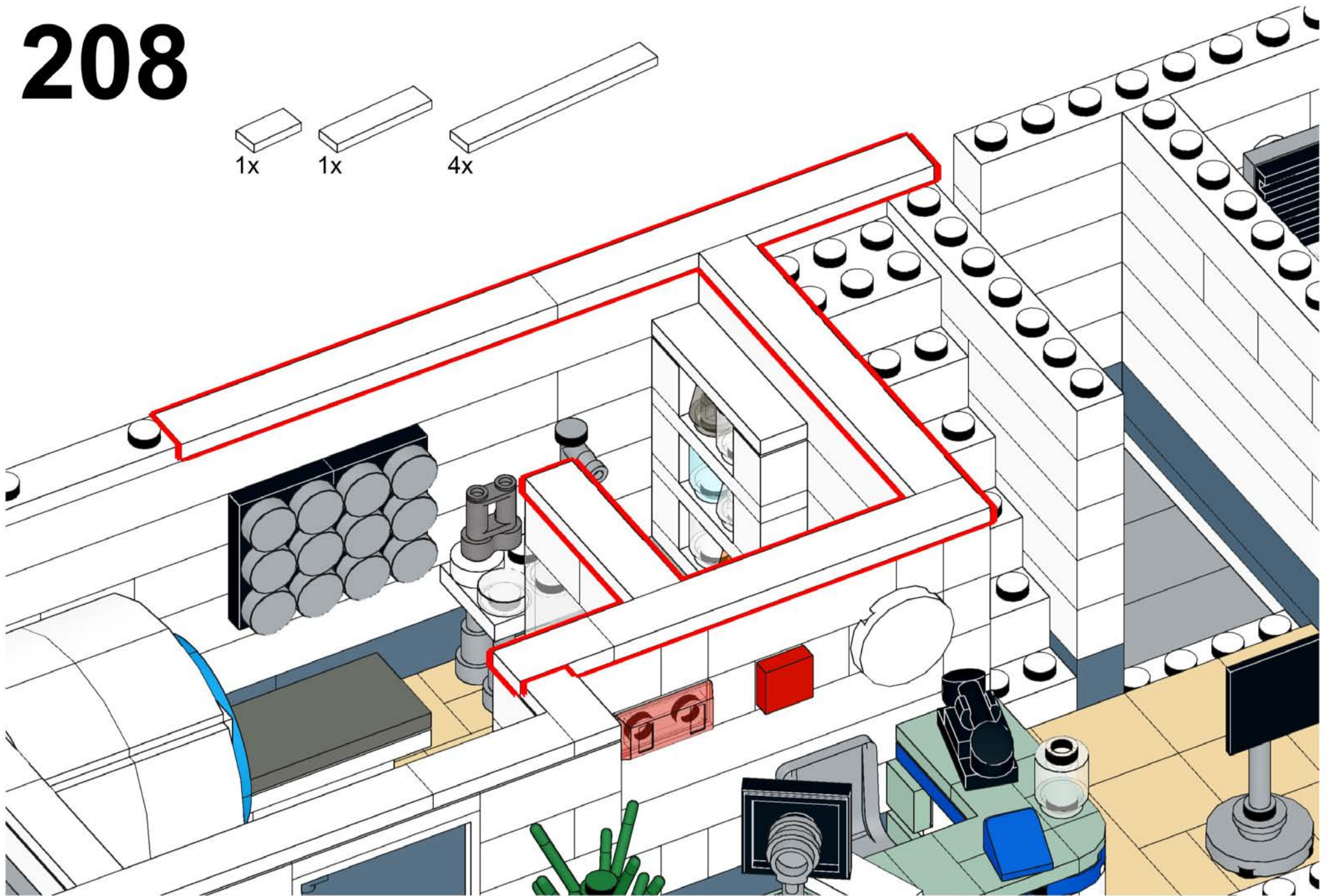

# 209

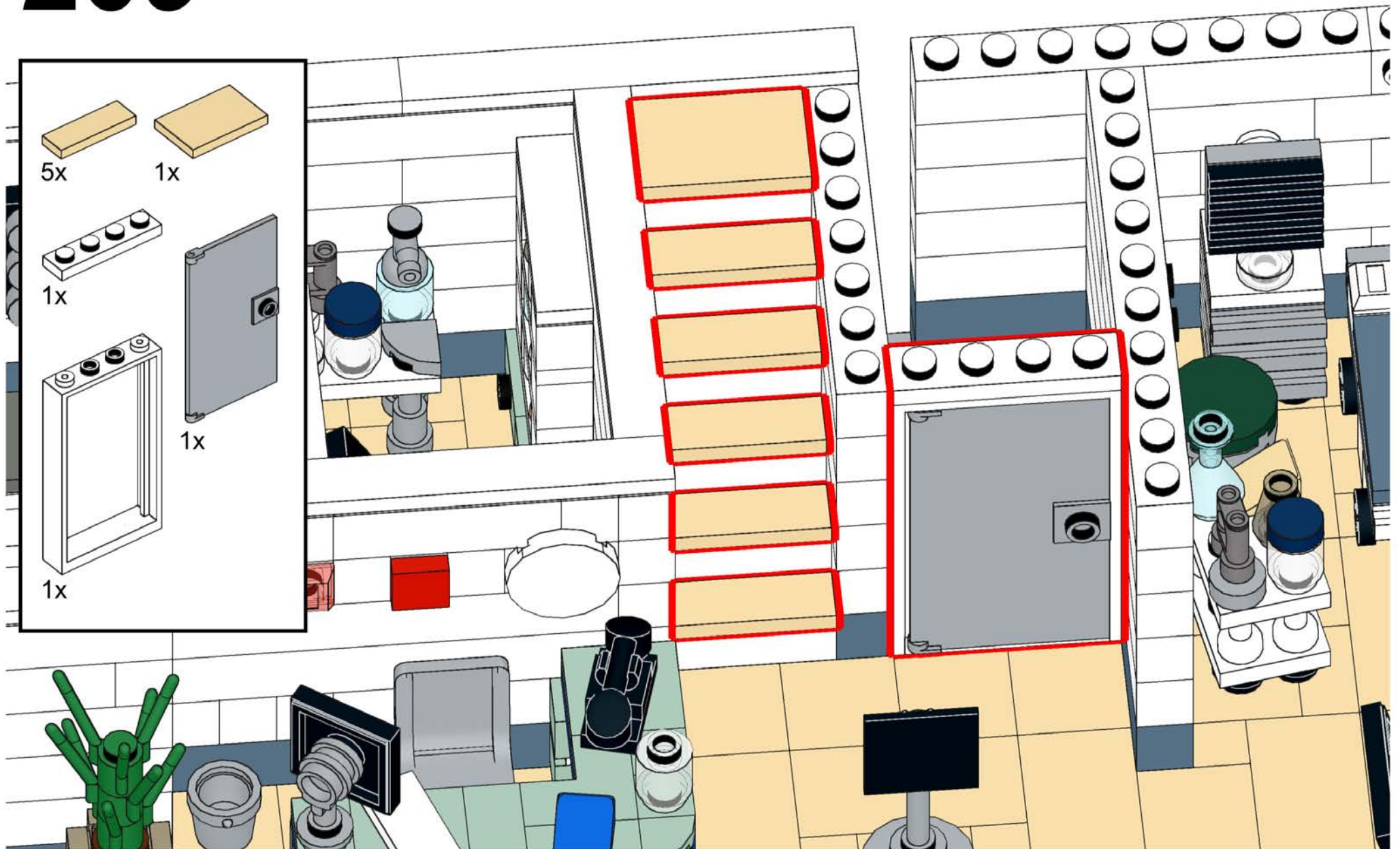

# 210

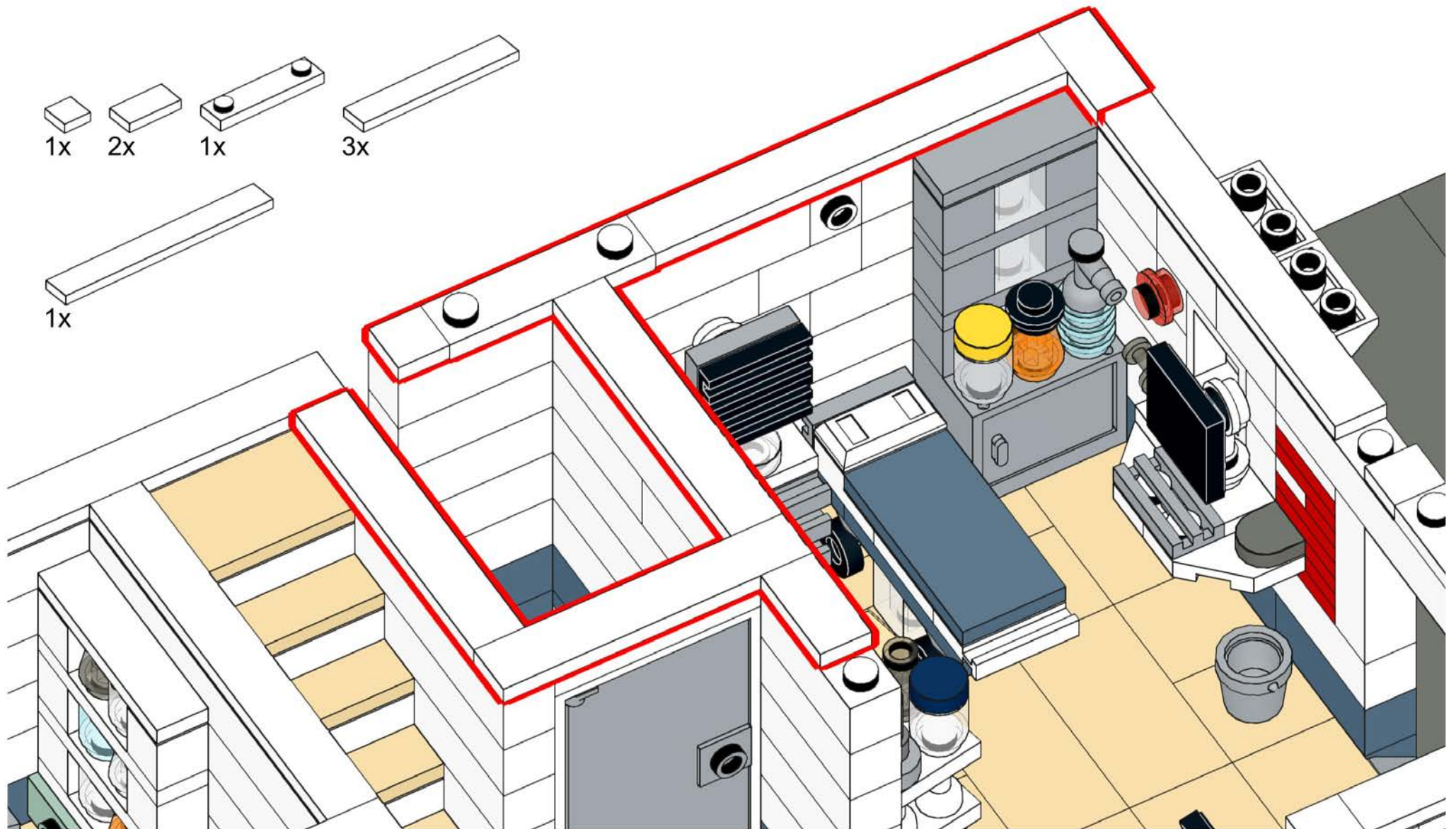



# 211

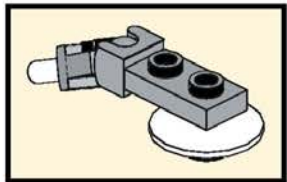
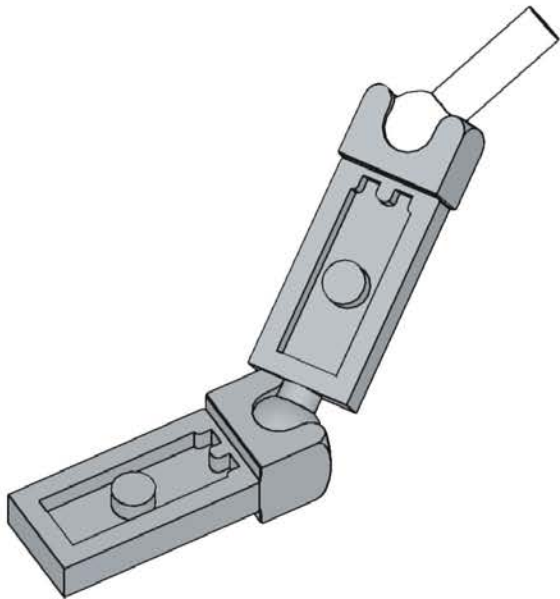
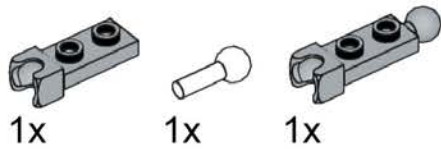

# 212

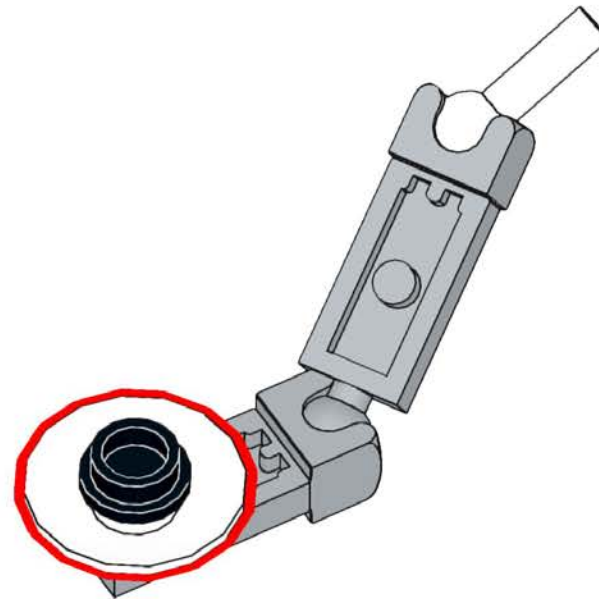
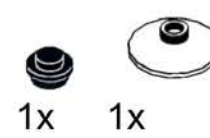

# 213

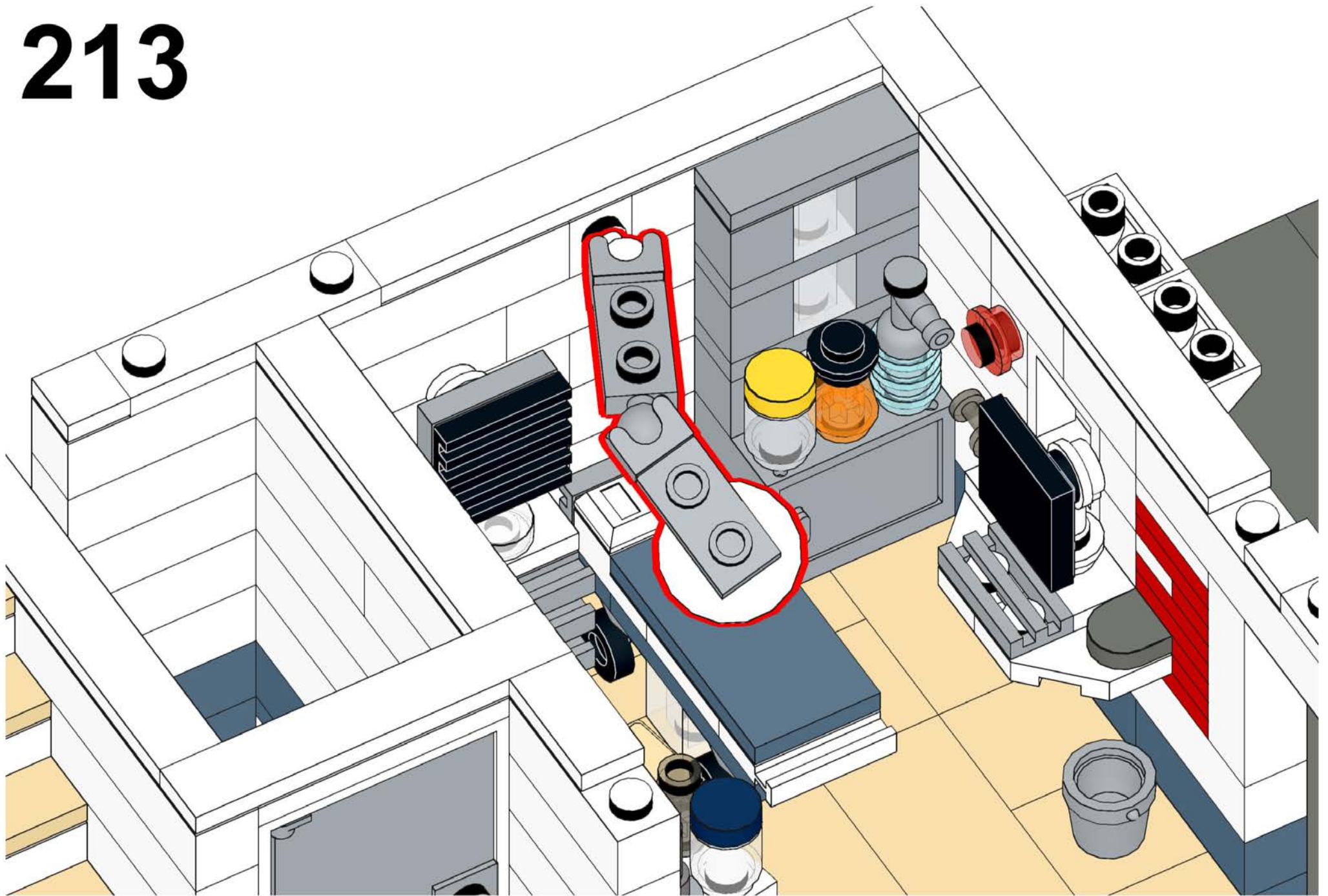

# 214

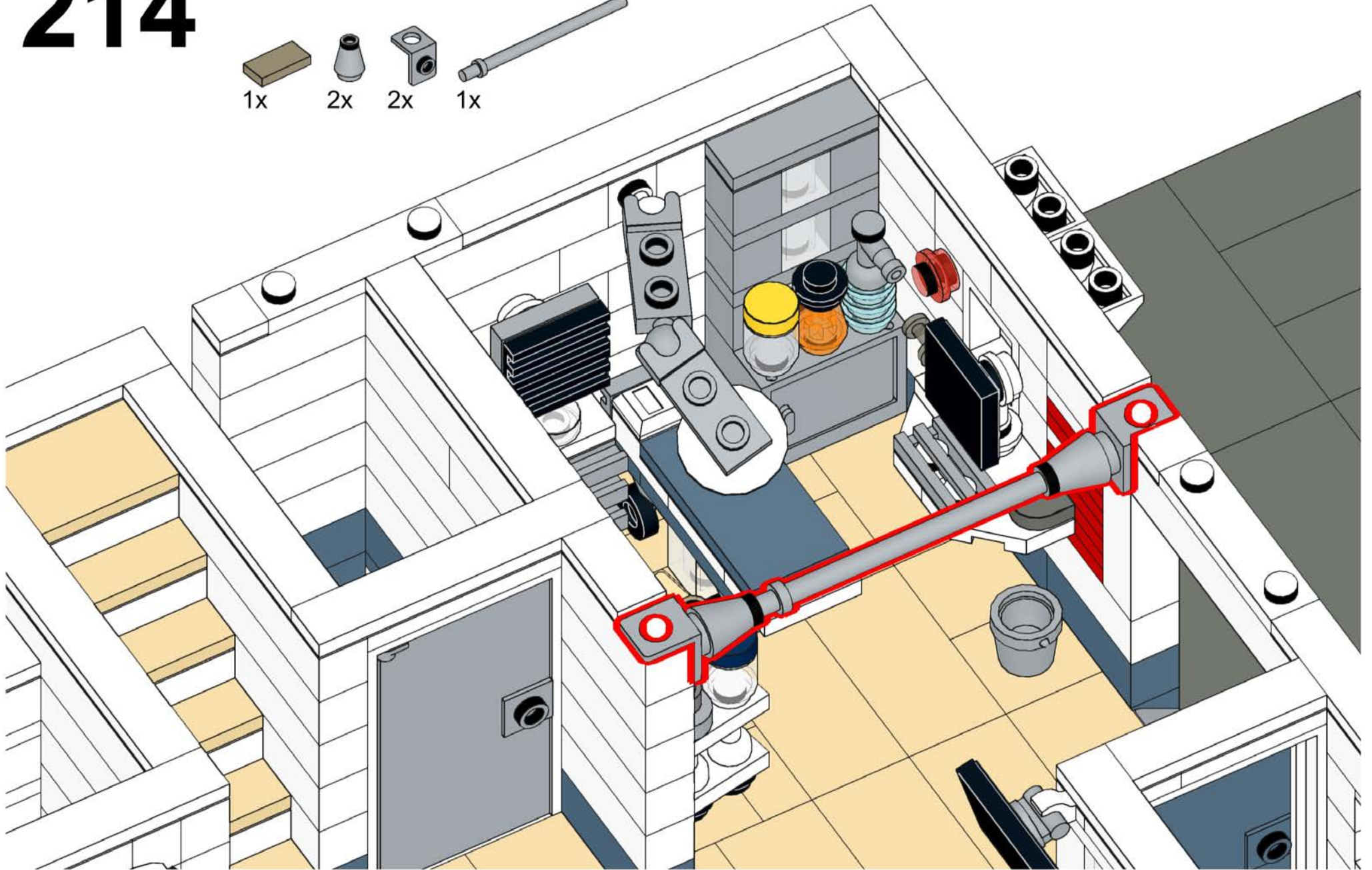
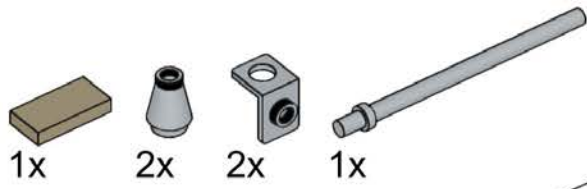

# 215

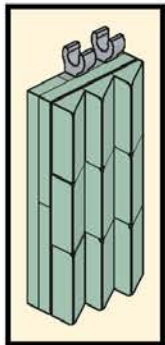
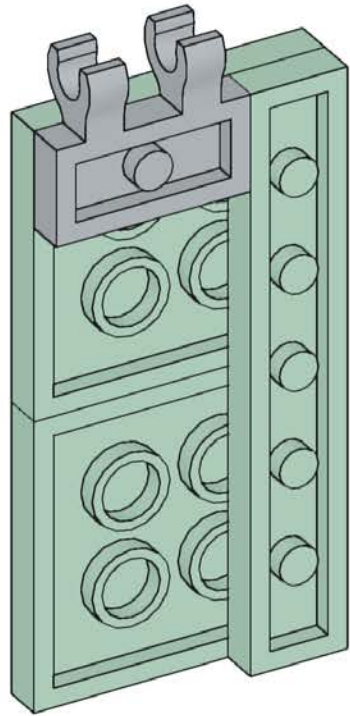
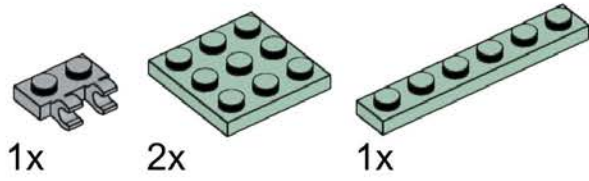

# 216

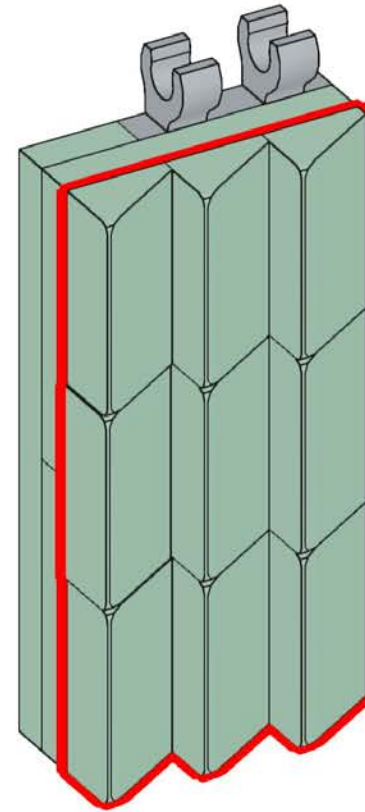
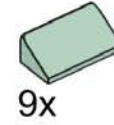

217

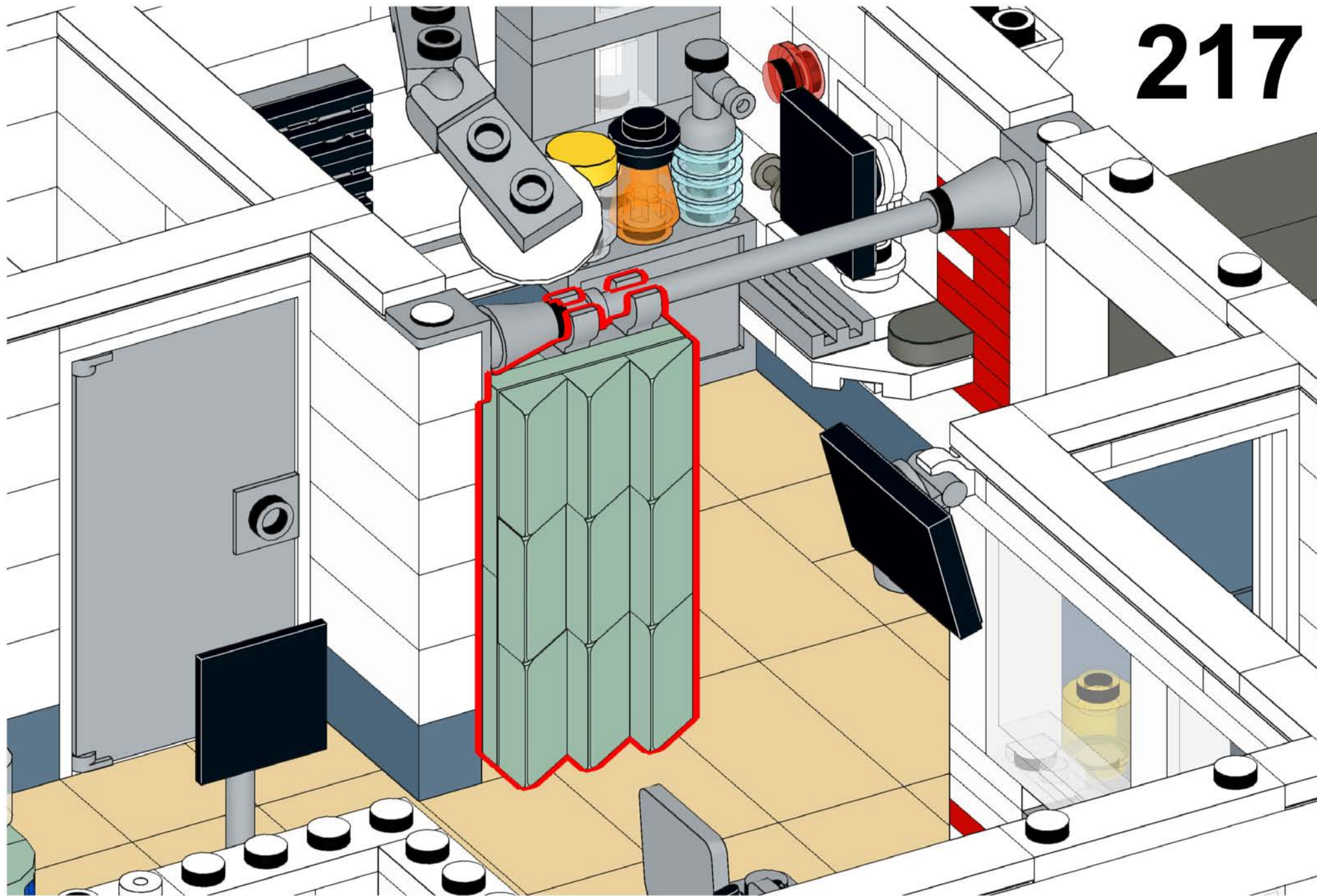

# 218

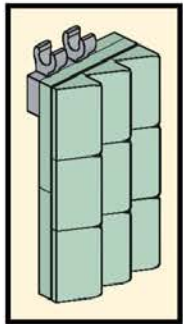
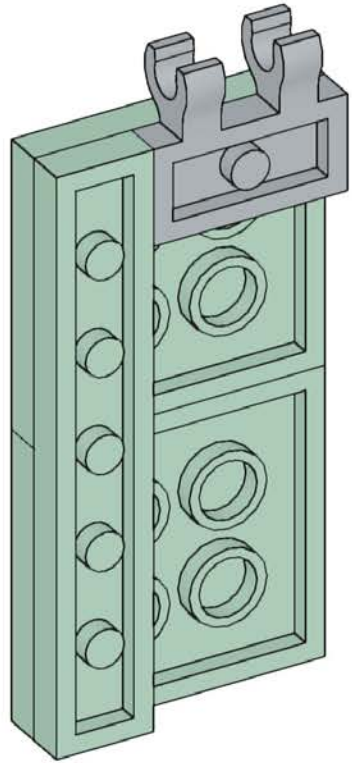
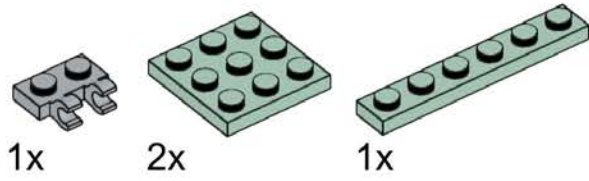

# 219

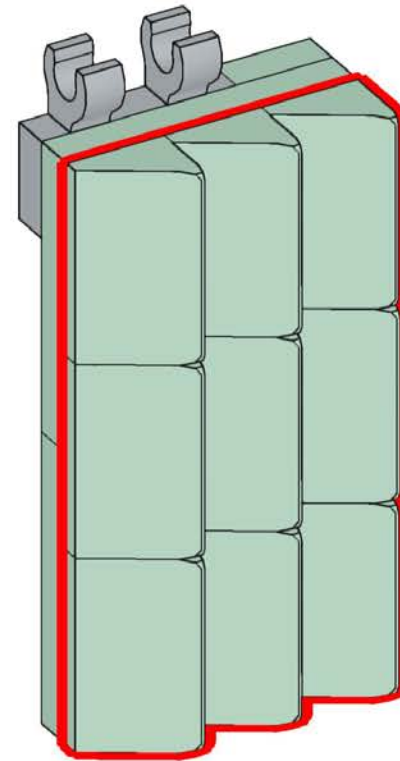
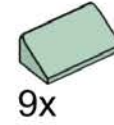

220

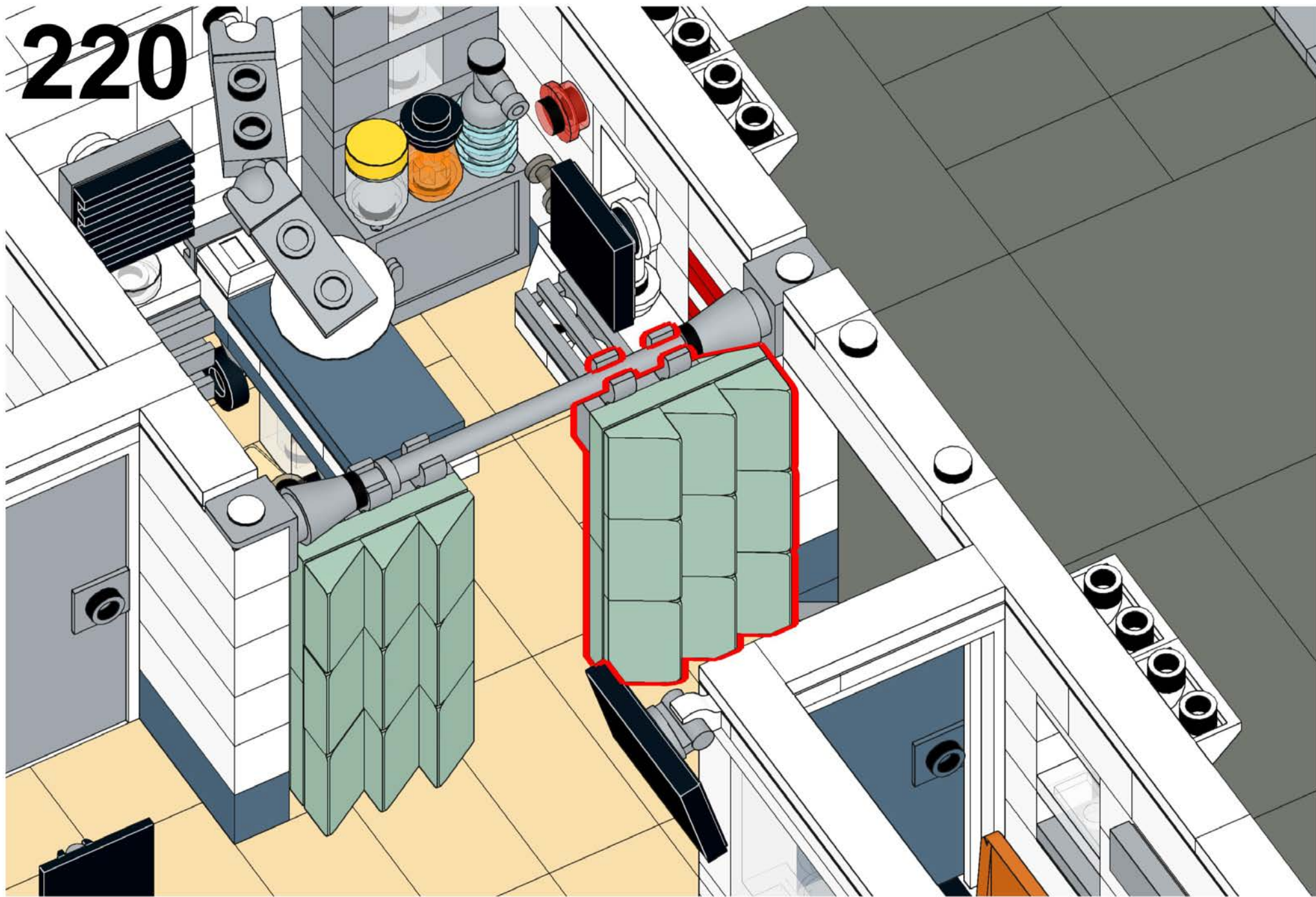

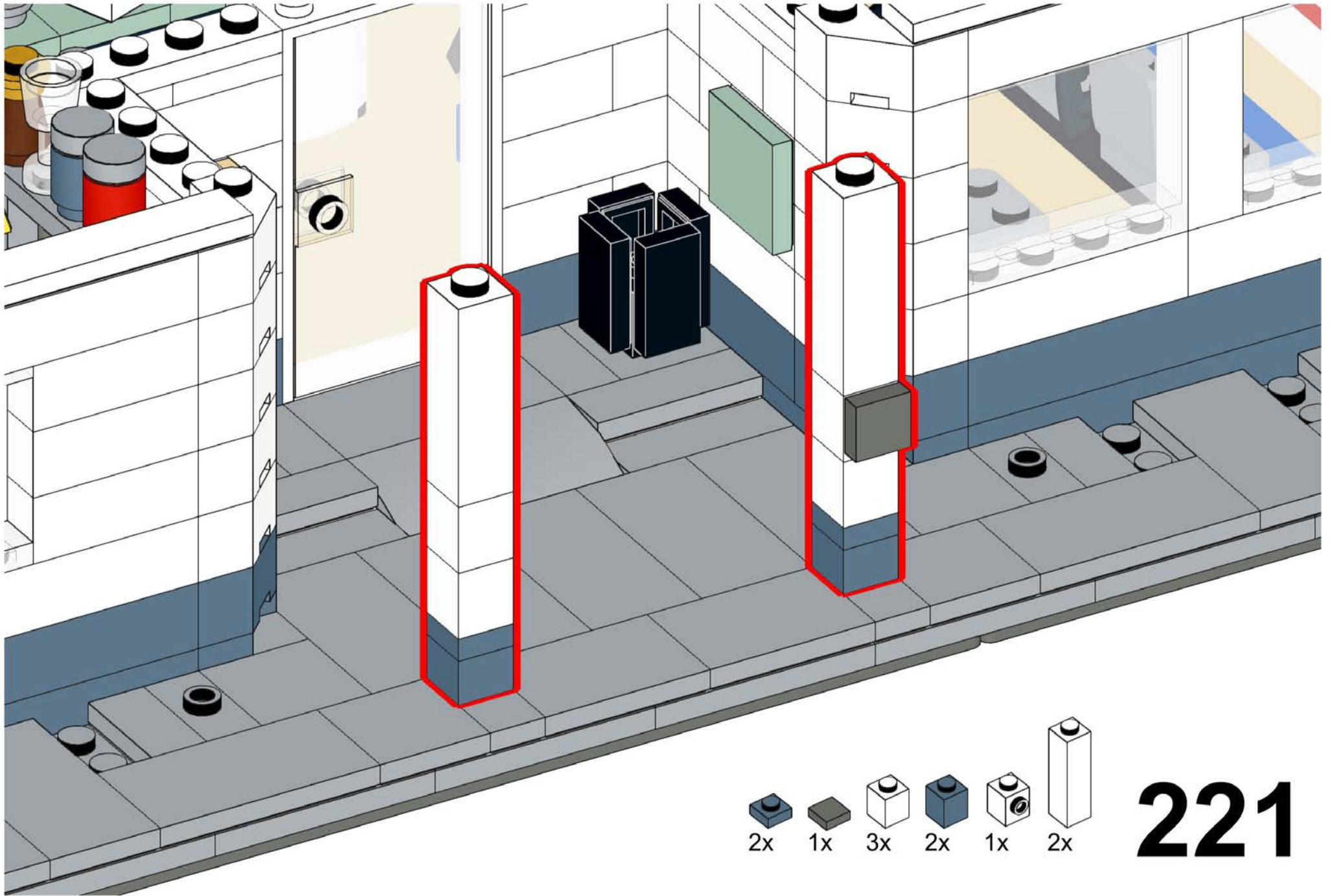



# 222

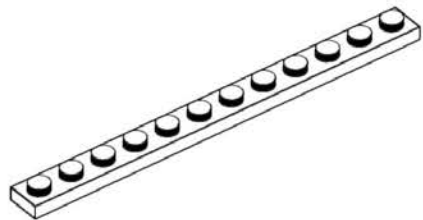

1x

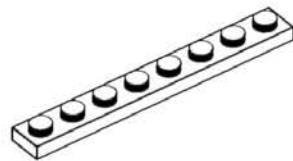

2x

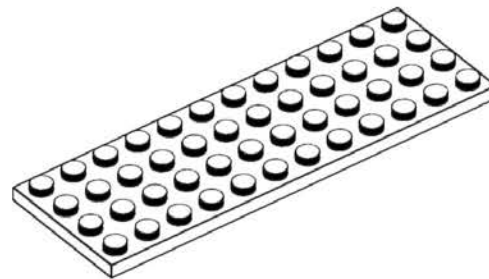

1x

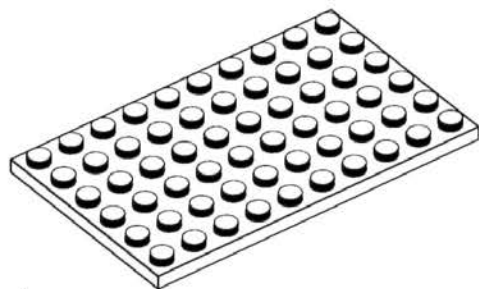

1x

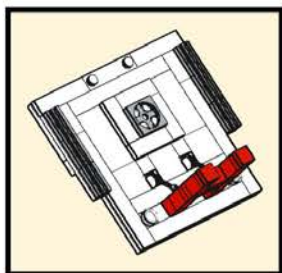
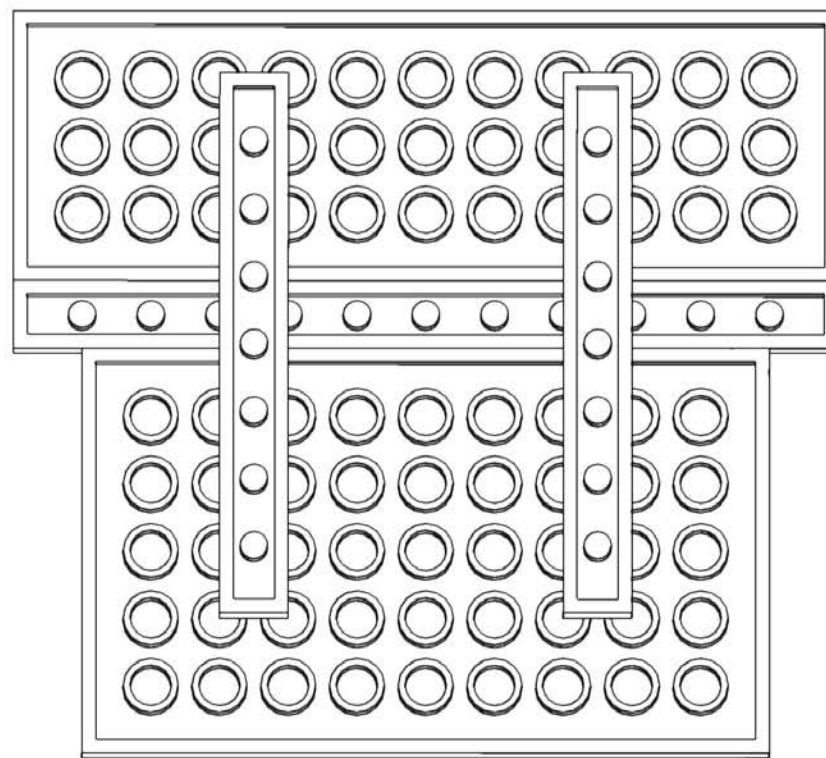

# 223

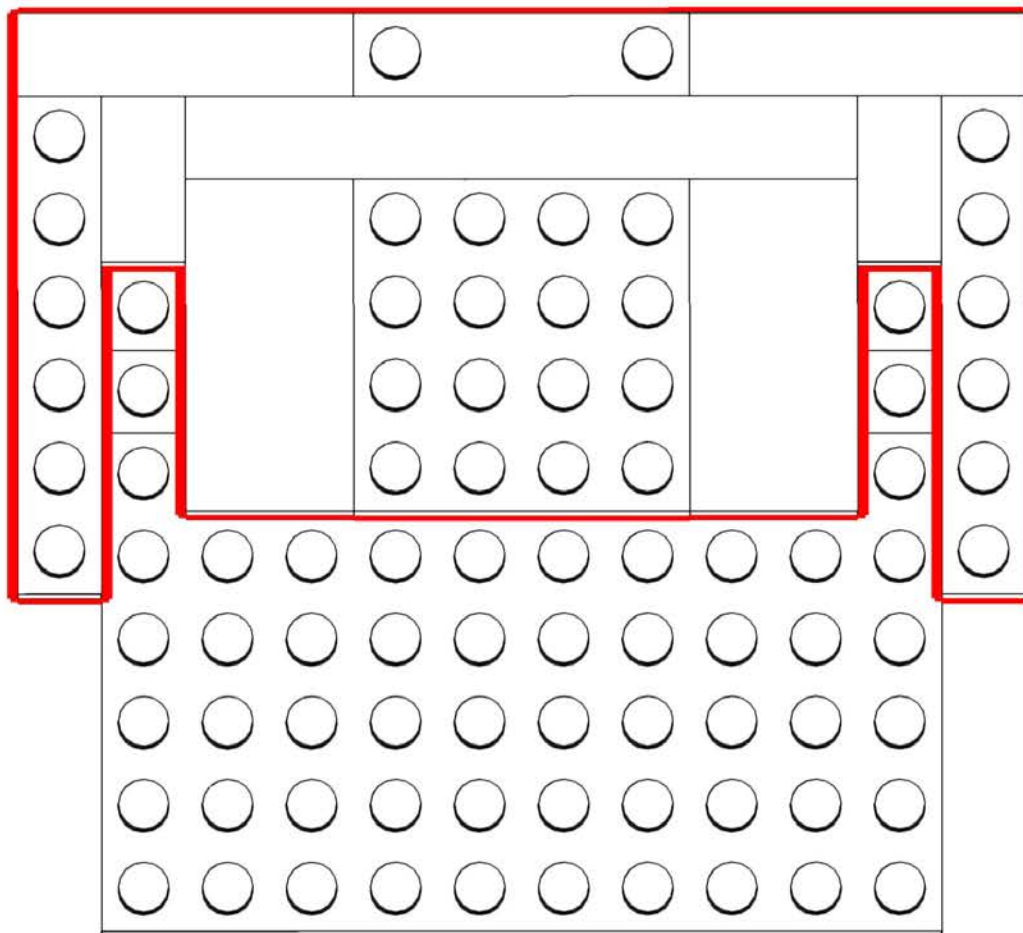
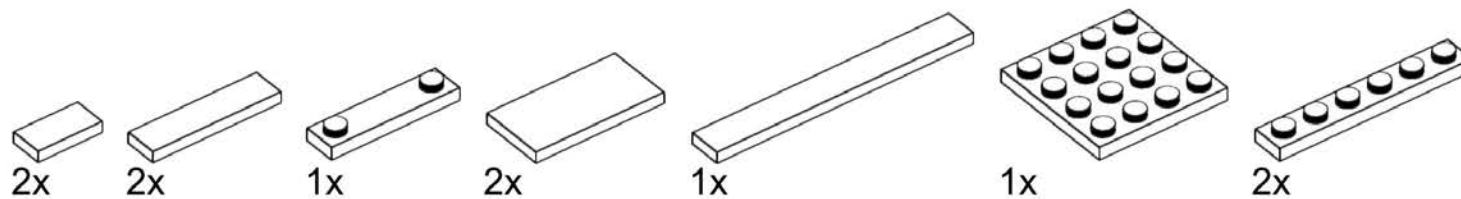

# 224

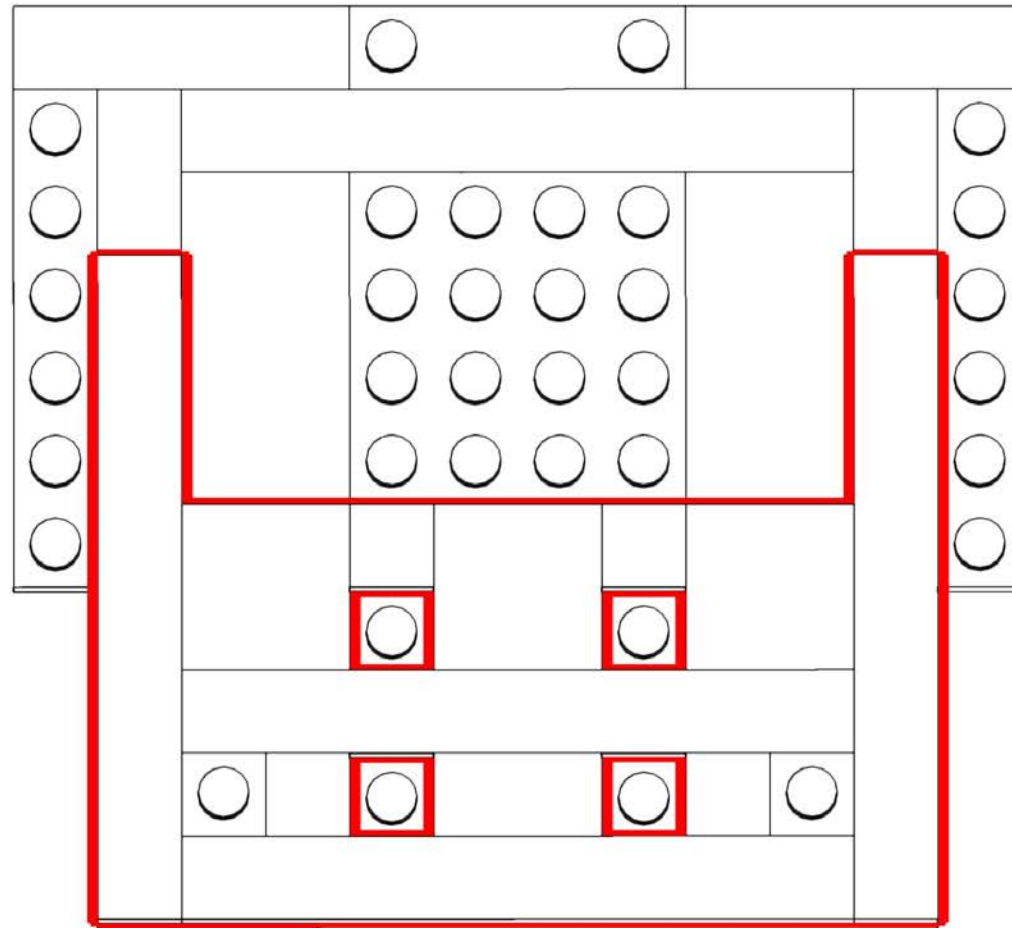
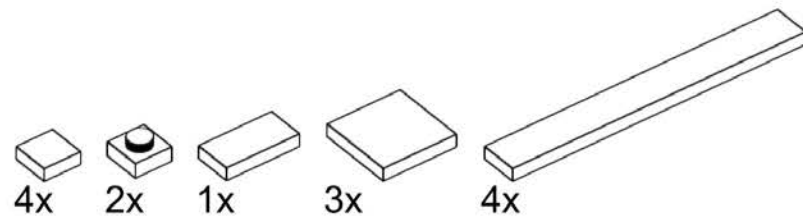

# 225

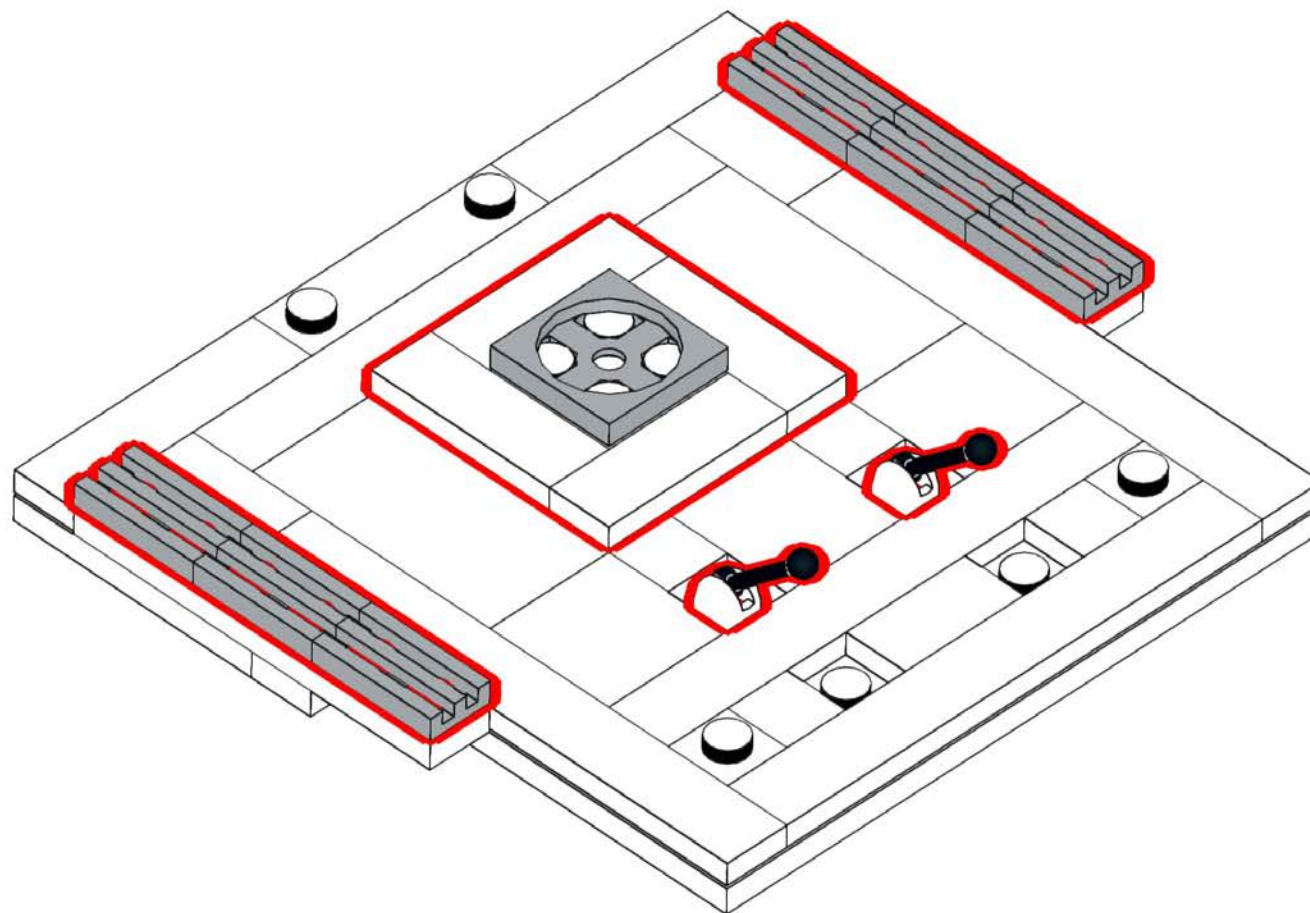
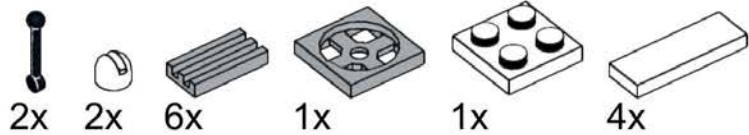

# 226

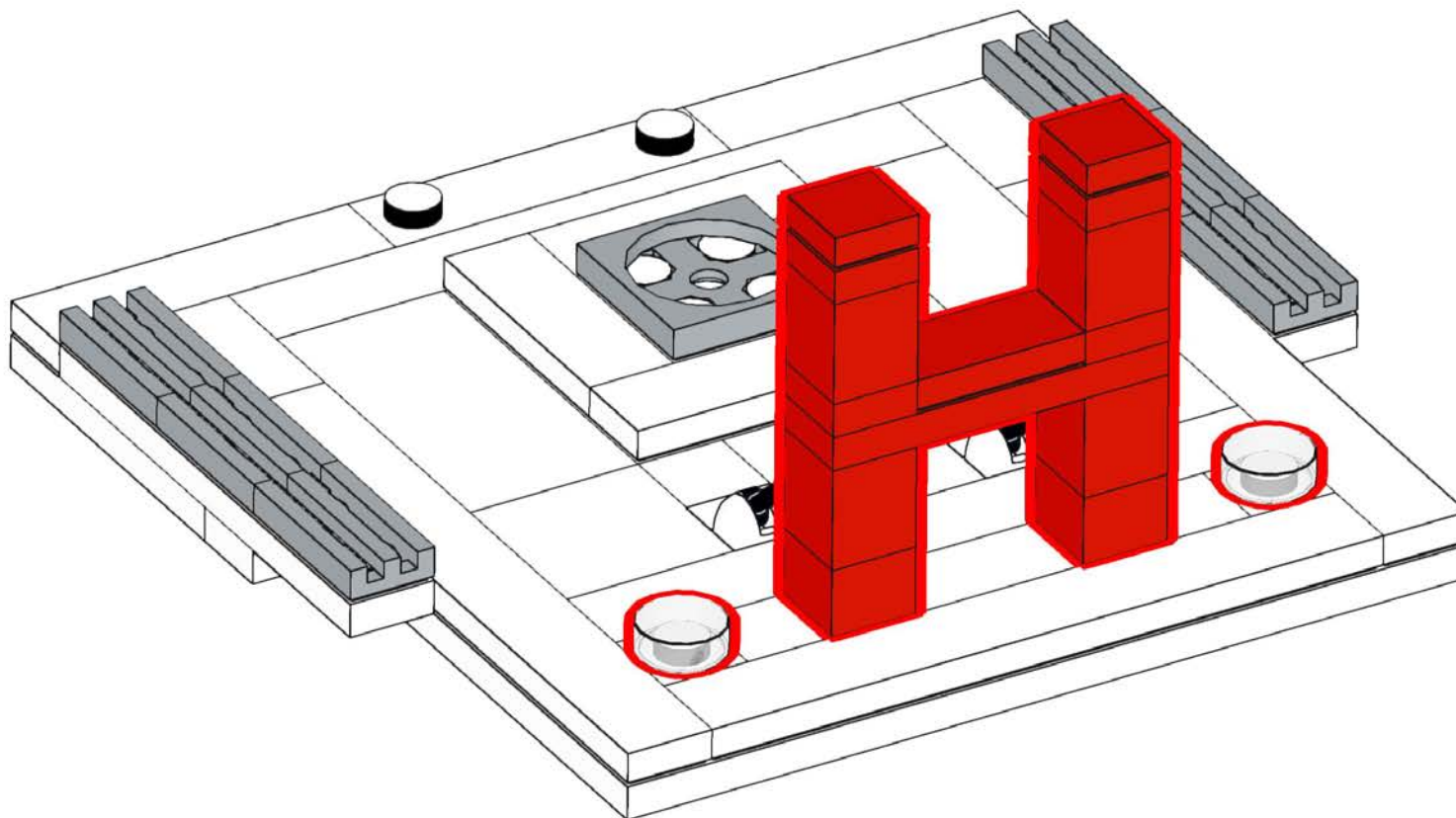
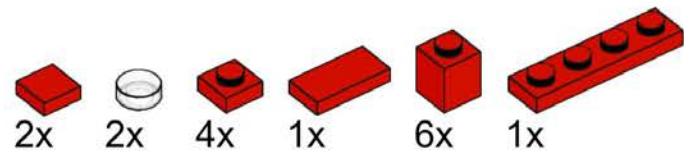

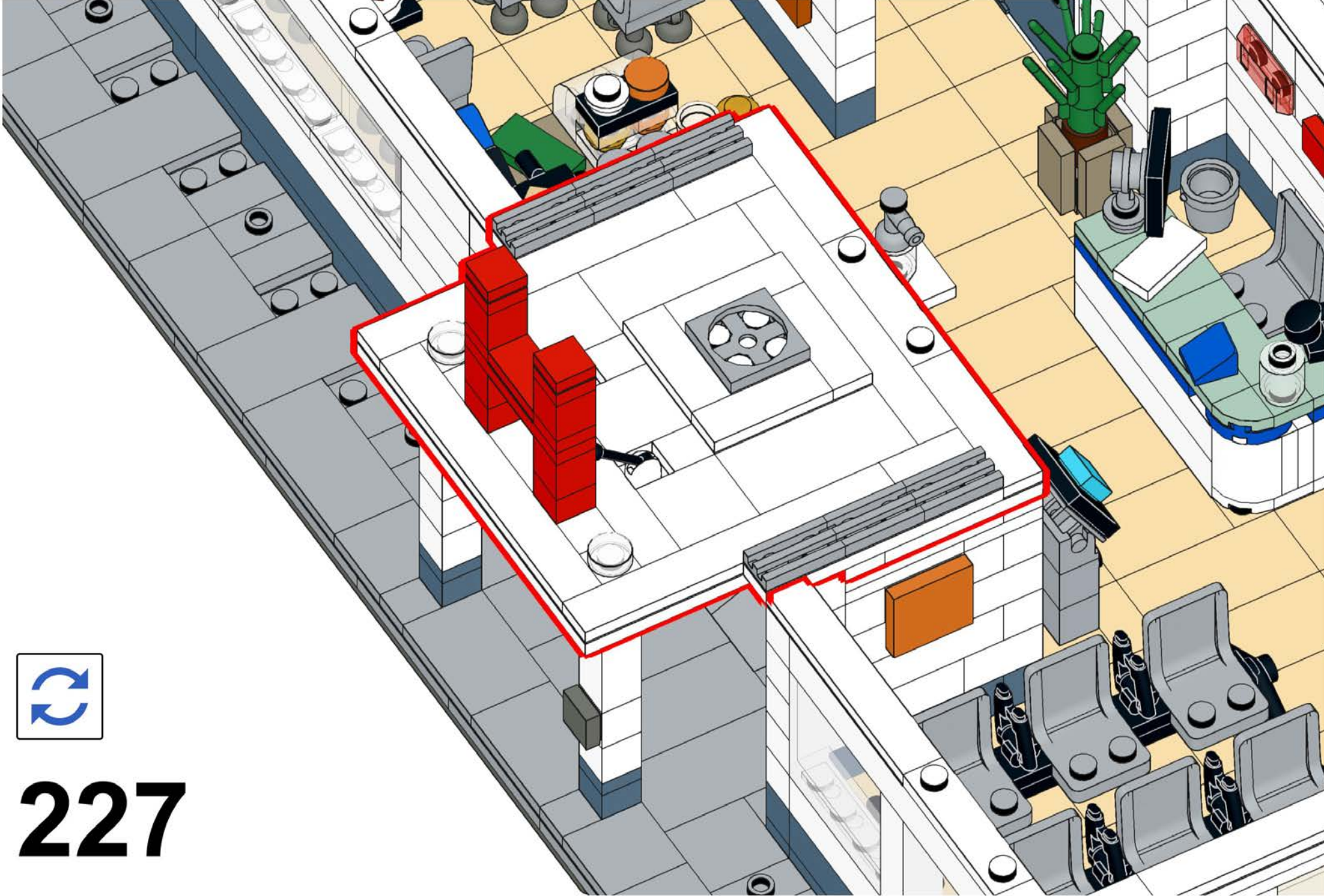

227

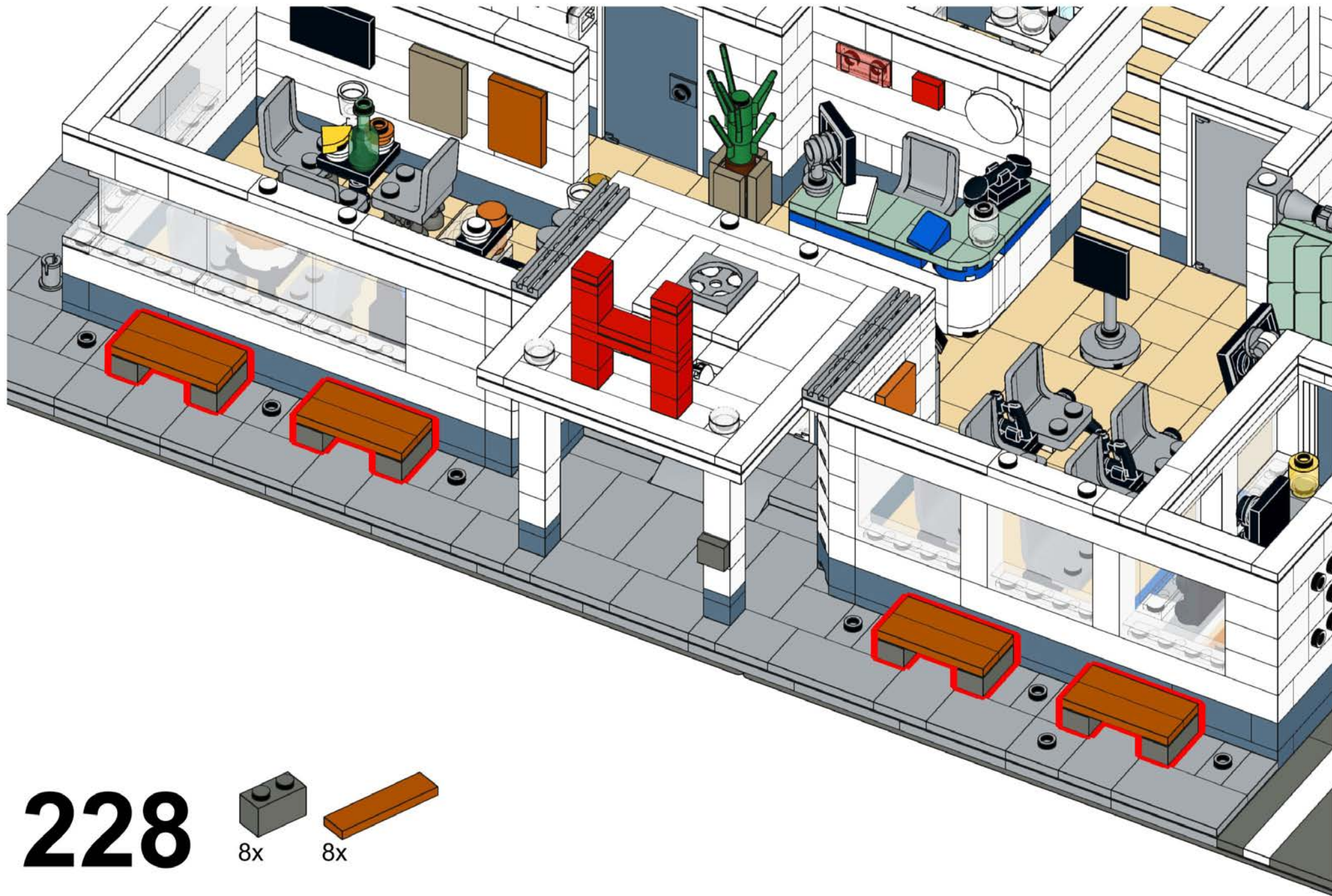

228



8x

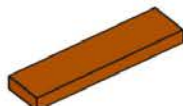

8x

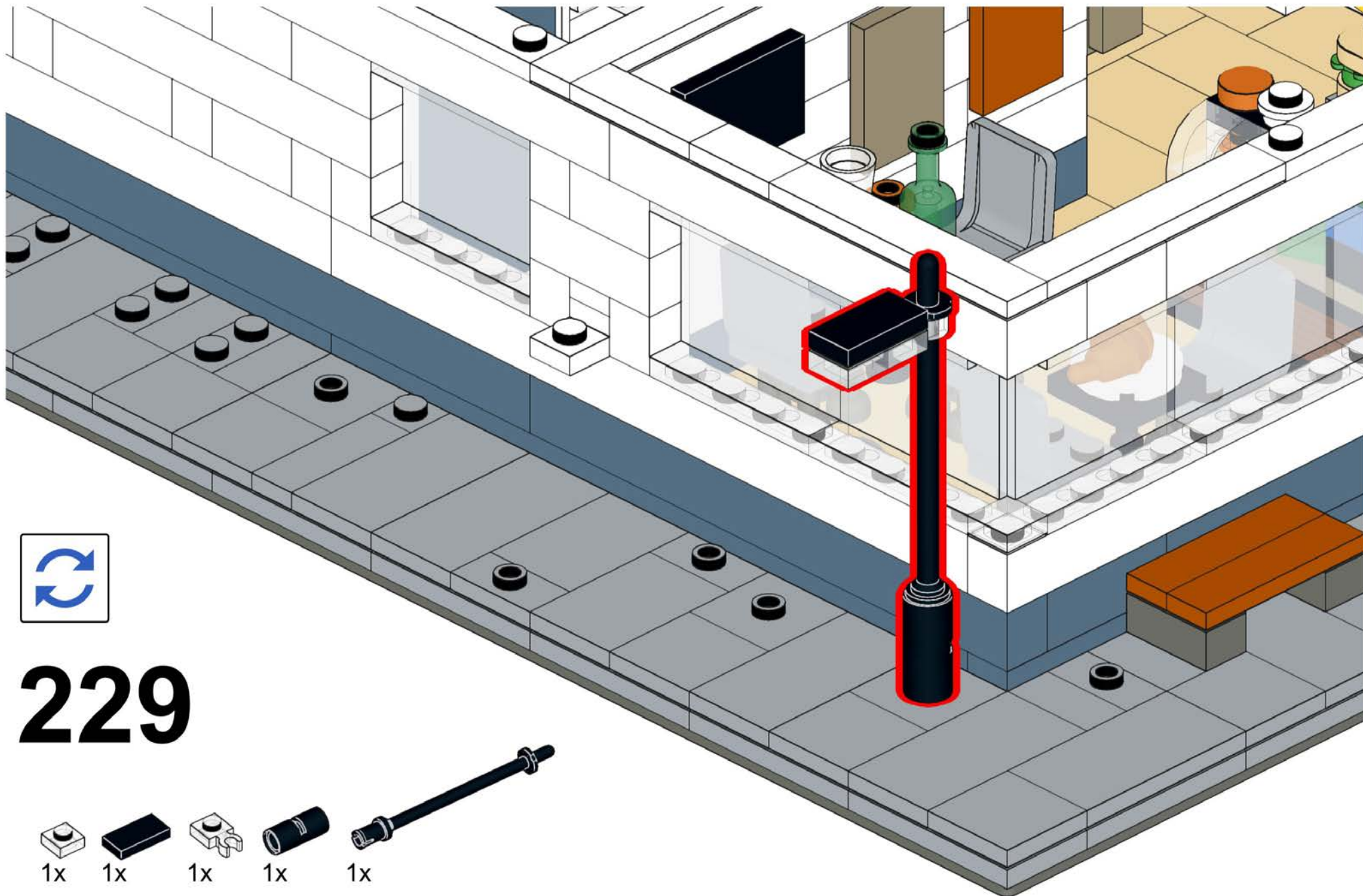



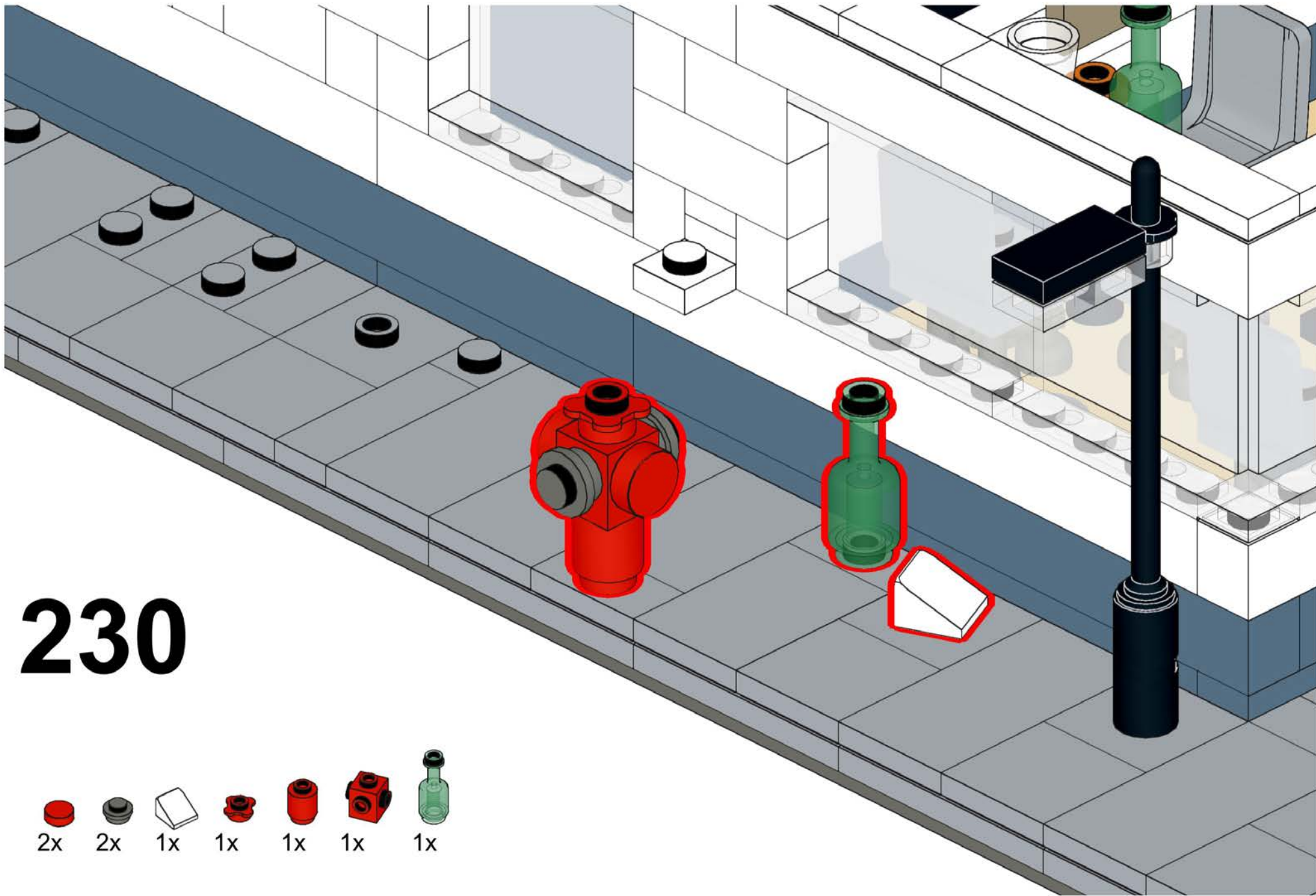

# 231

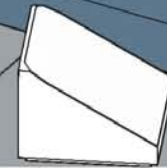
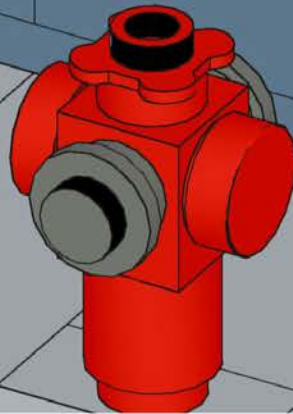
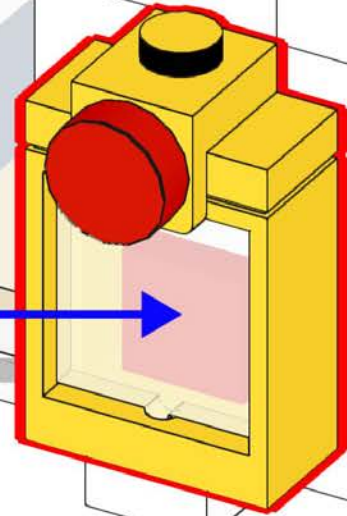
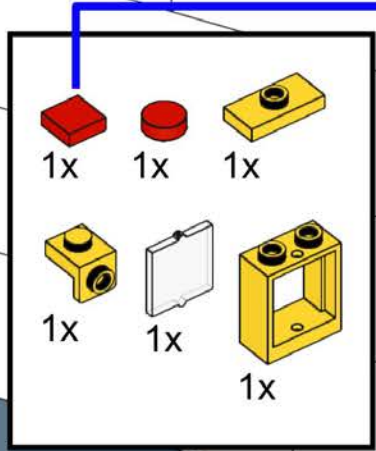

# 232

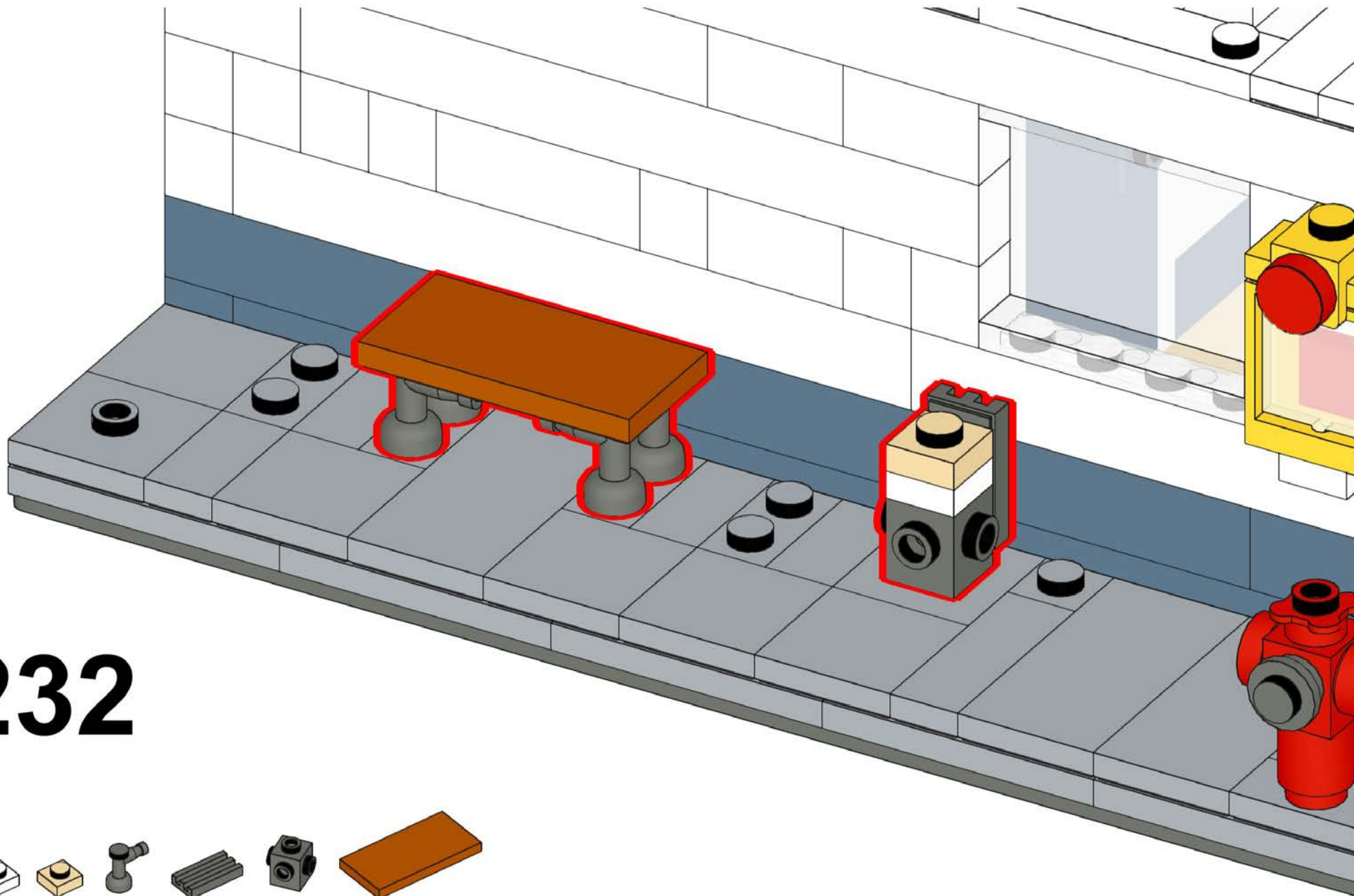
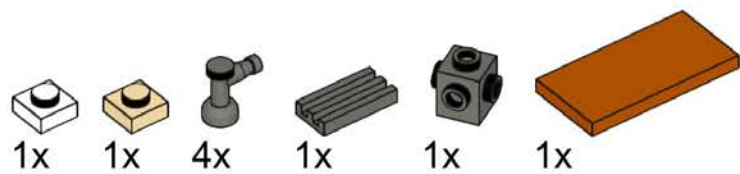

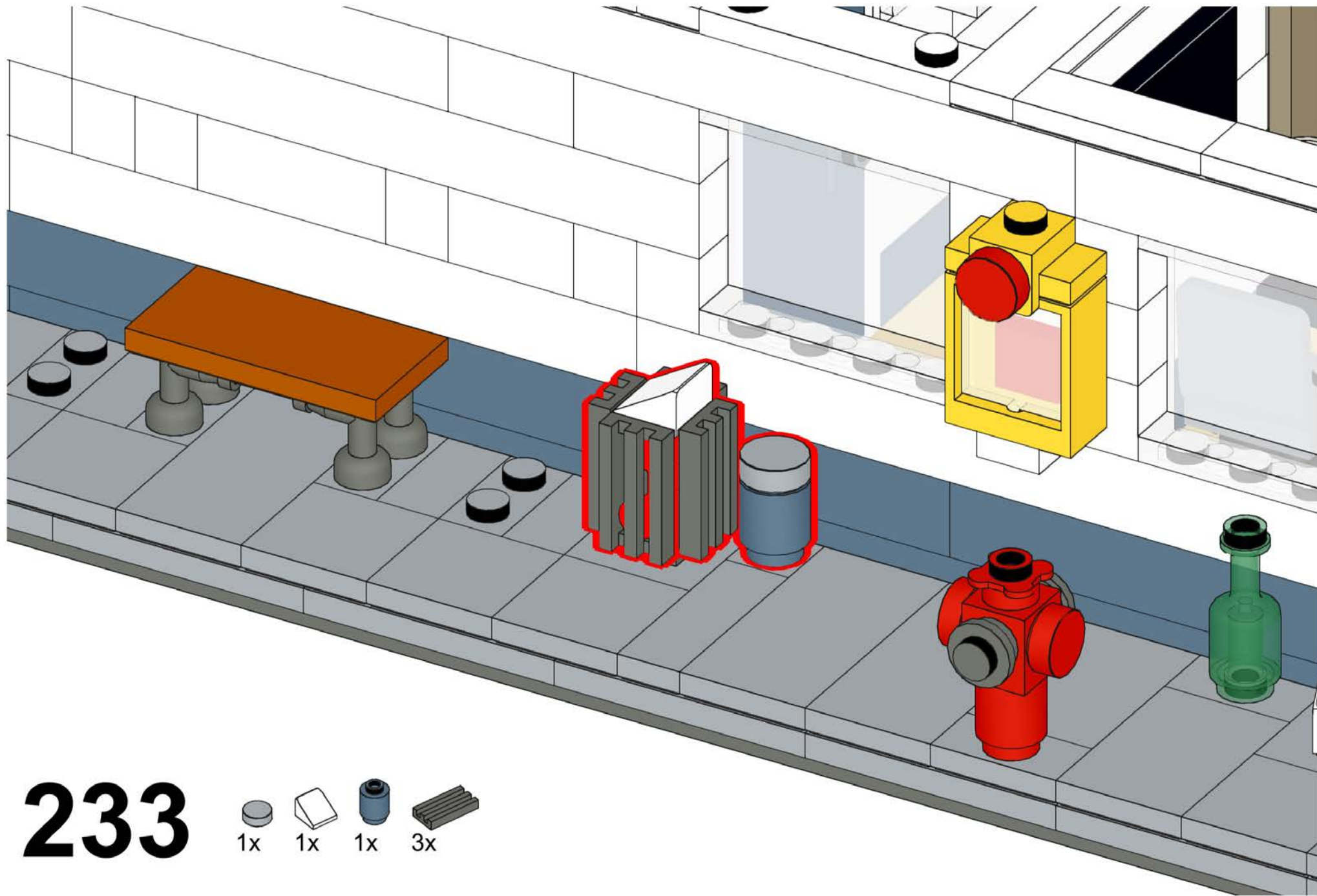

**233**



1x



1x



1x



3x

# 234

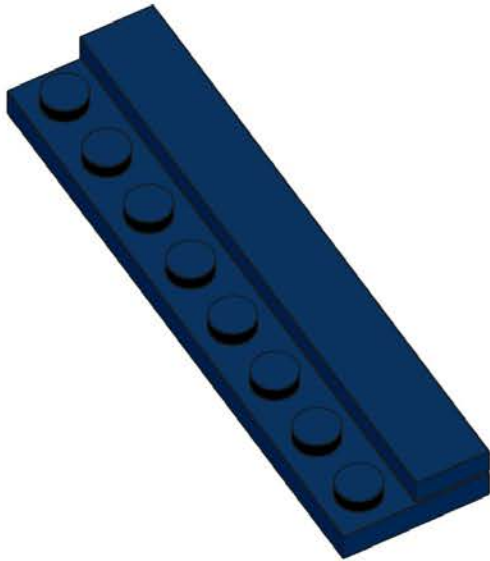
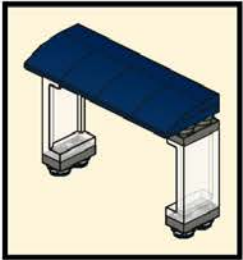

# 235

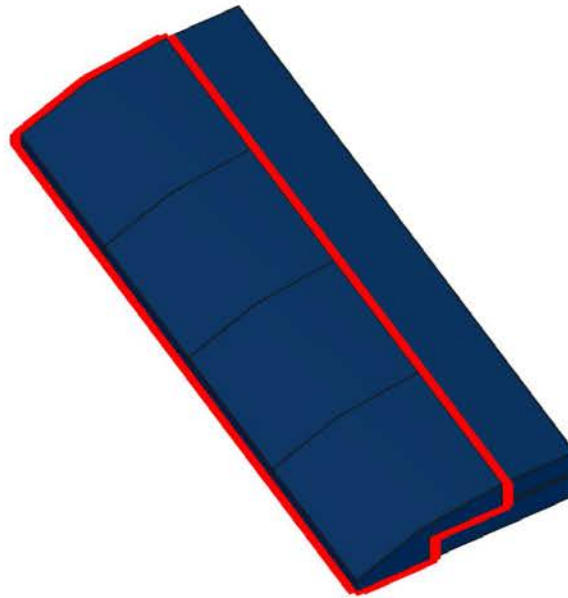
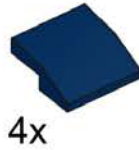

# 236

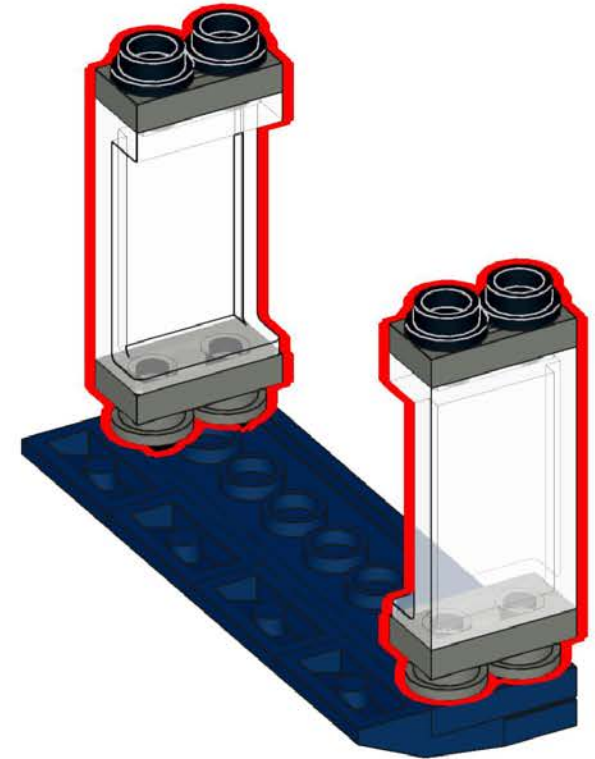
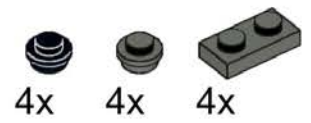

237

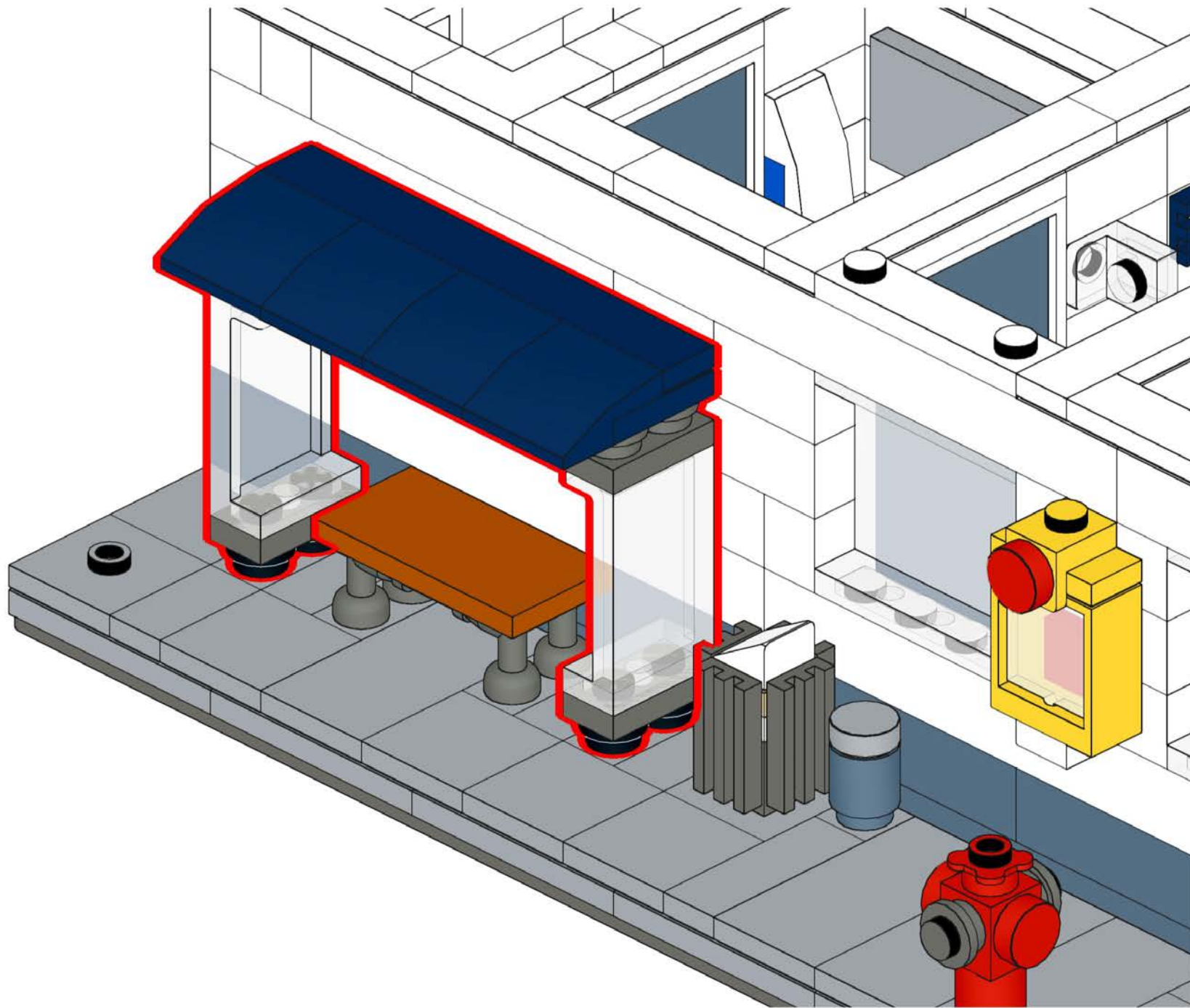

# 238



1x 2x

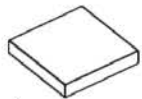

1x





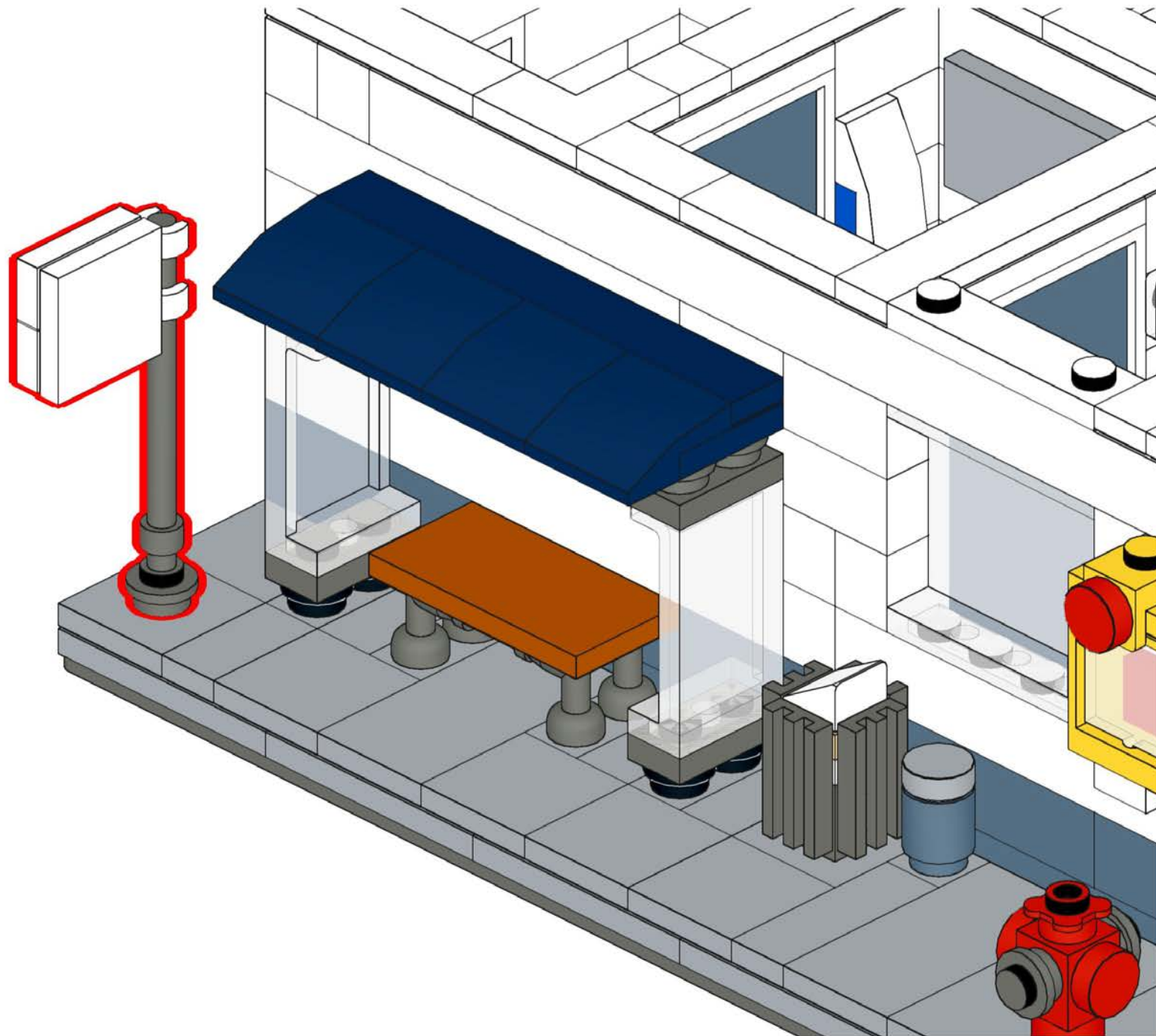

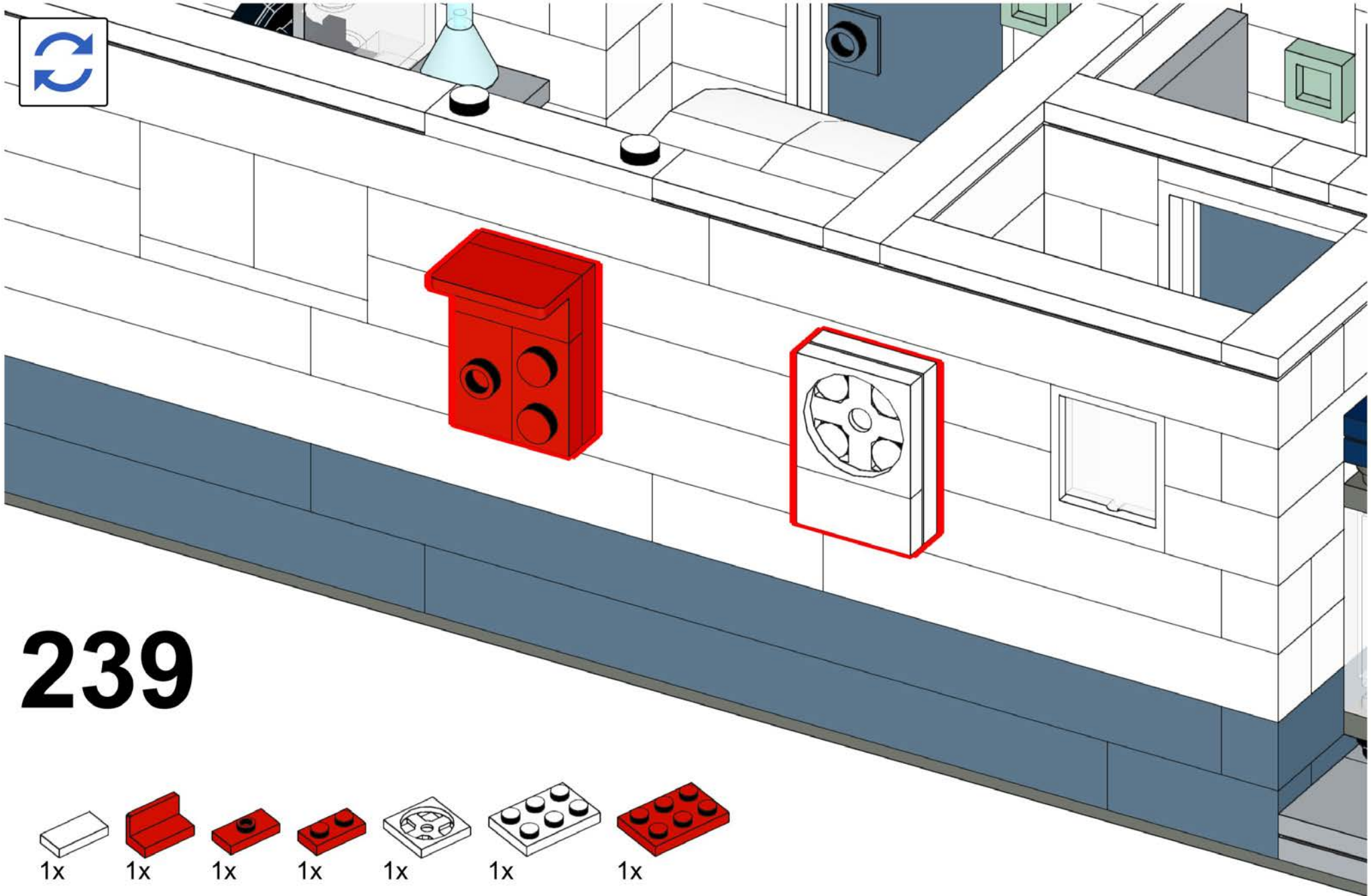

1x





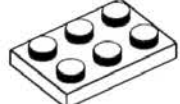





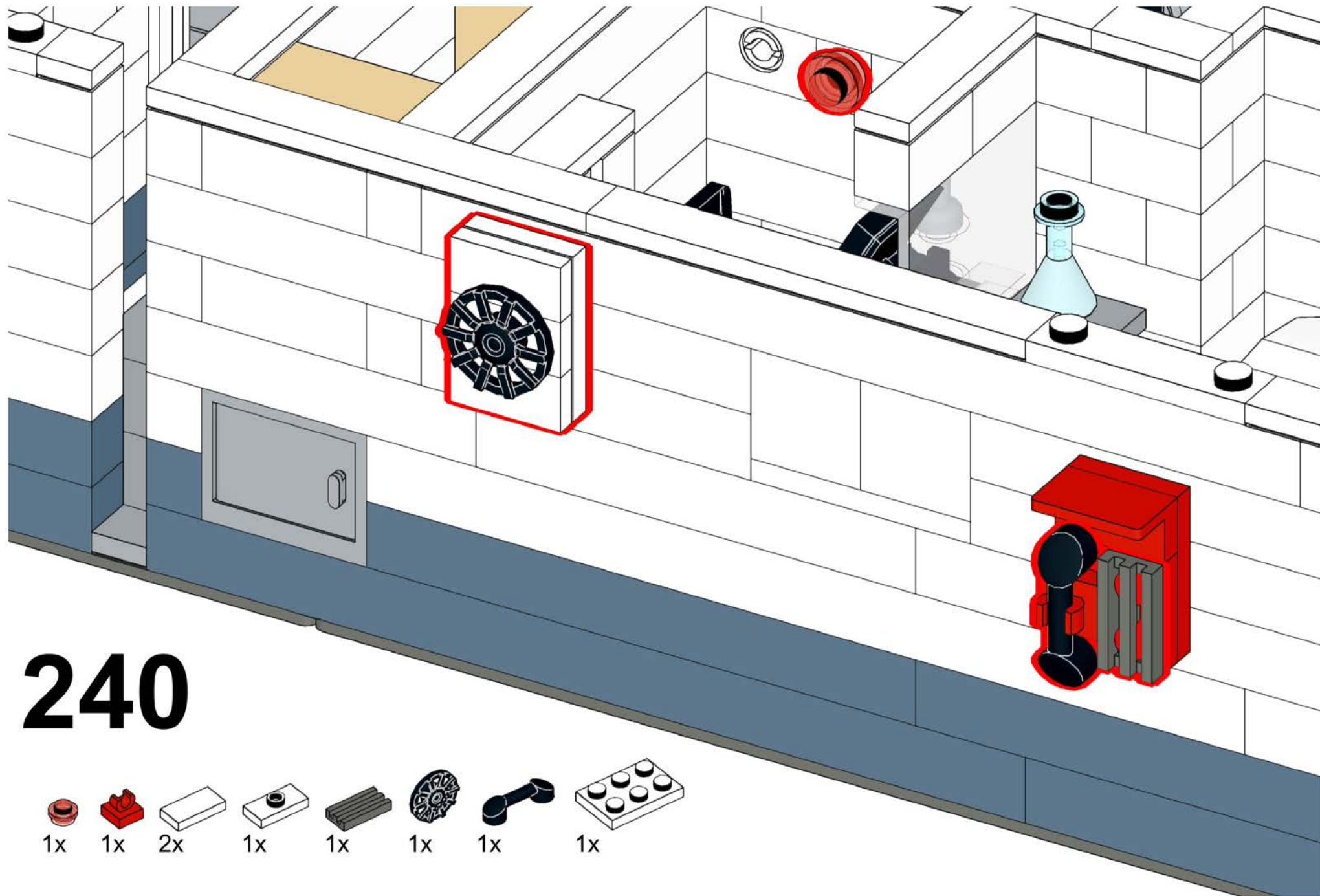

239

- 1x 
- 1x 
- 1x 
- 1x 
- 1x 
- 1x 
- 1x 



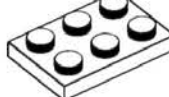

240

- 1x 
- 1x 
- 2x 
- 1x 
- 1x 
- 1x 
- 1x 
- 1x 

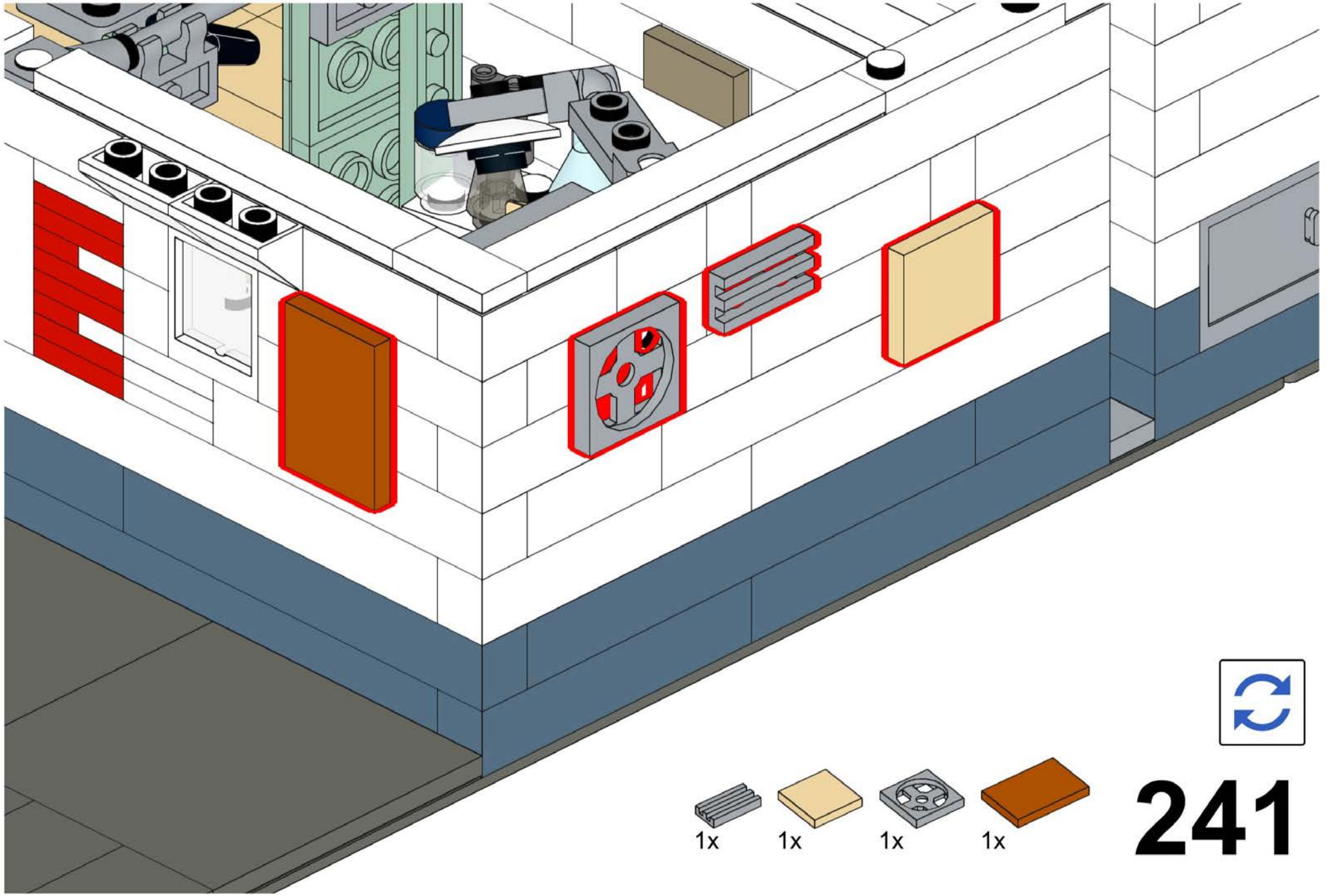

1x

1x

1x

1x



241

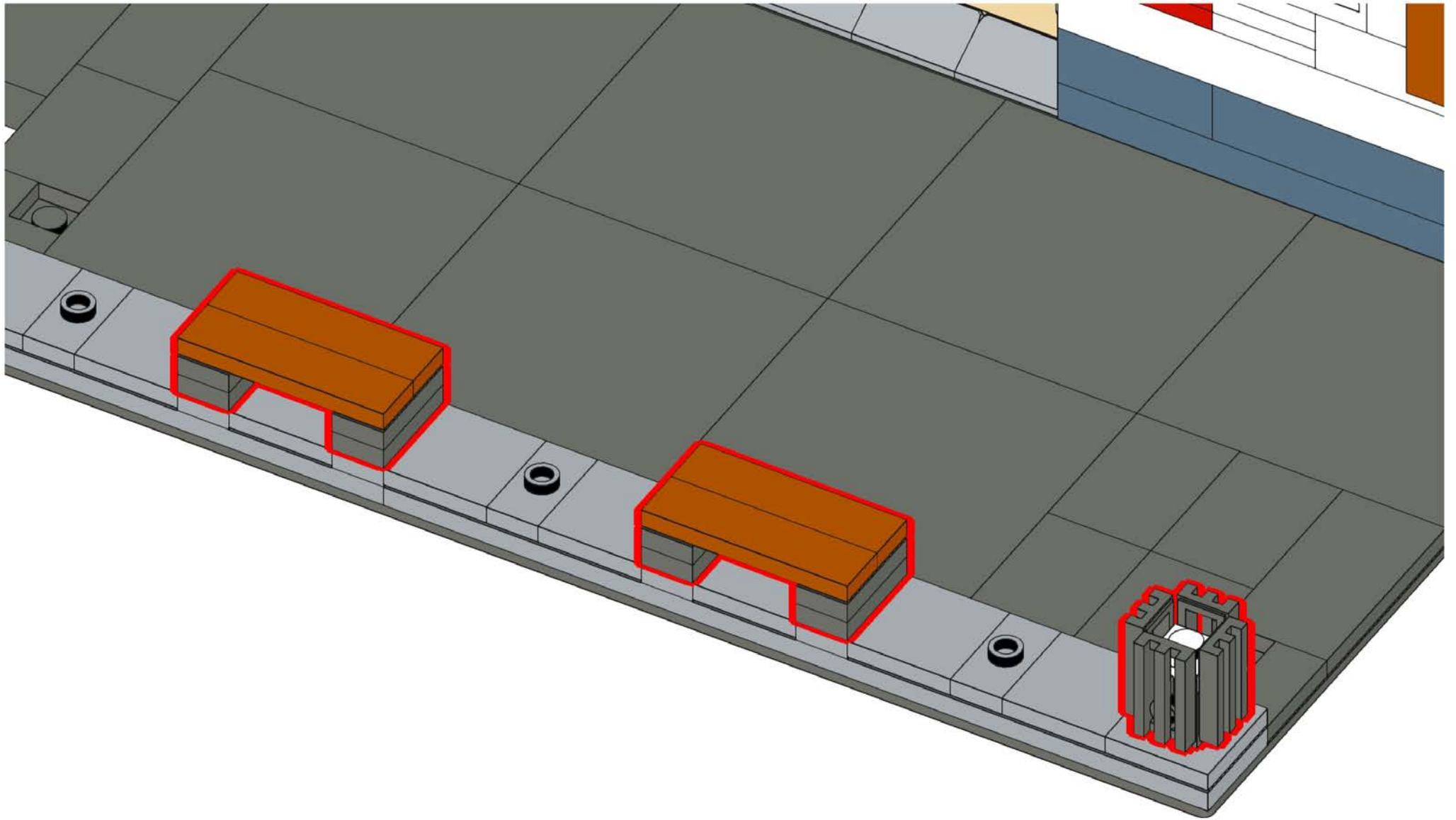

**242**



1x



8x



4x



1x

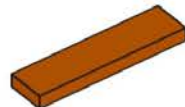

4x

# 243

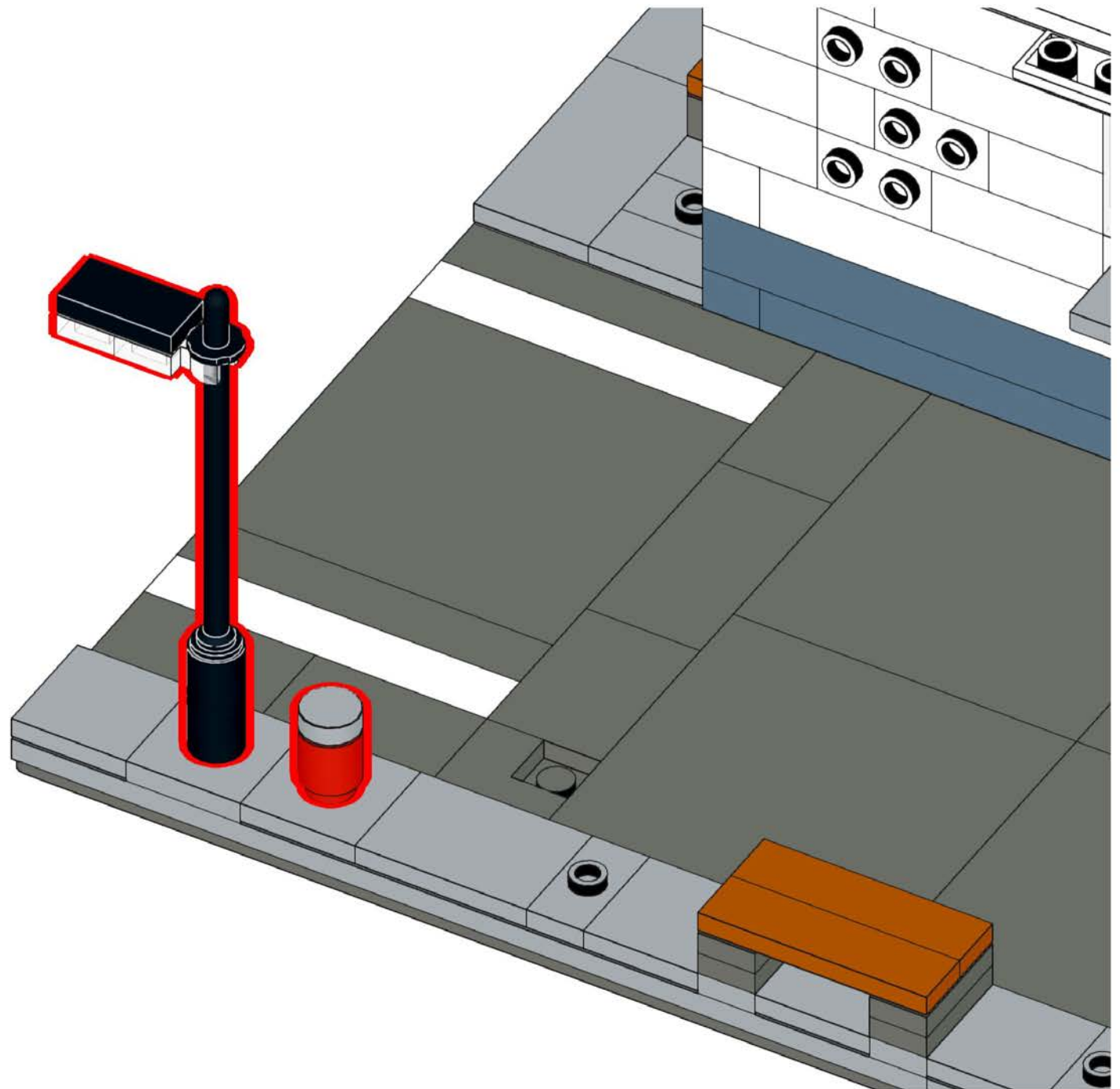
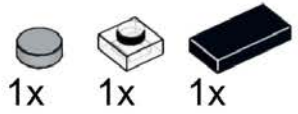

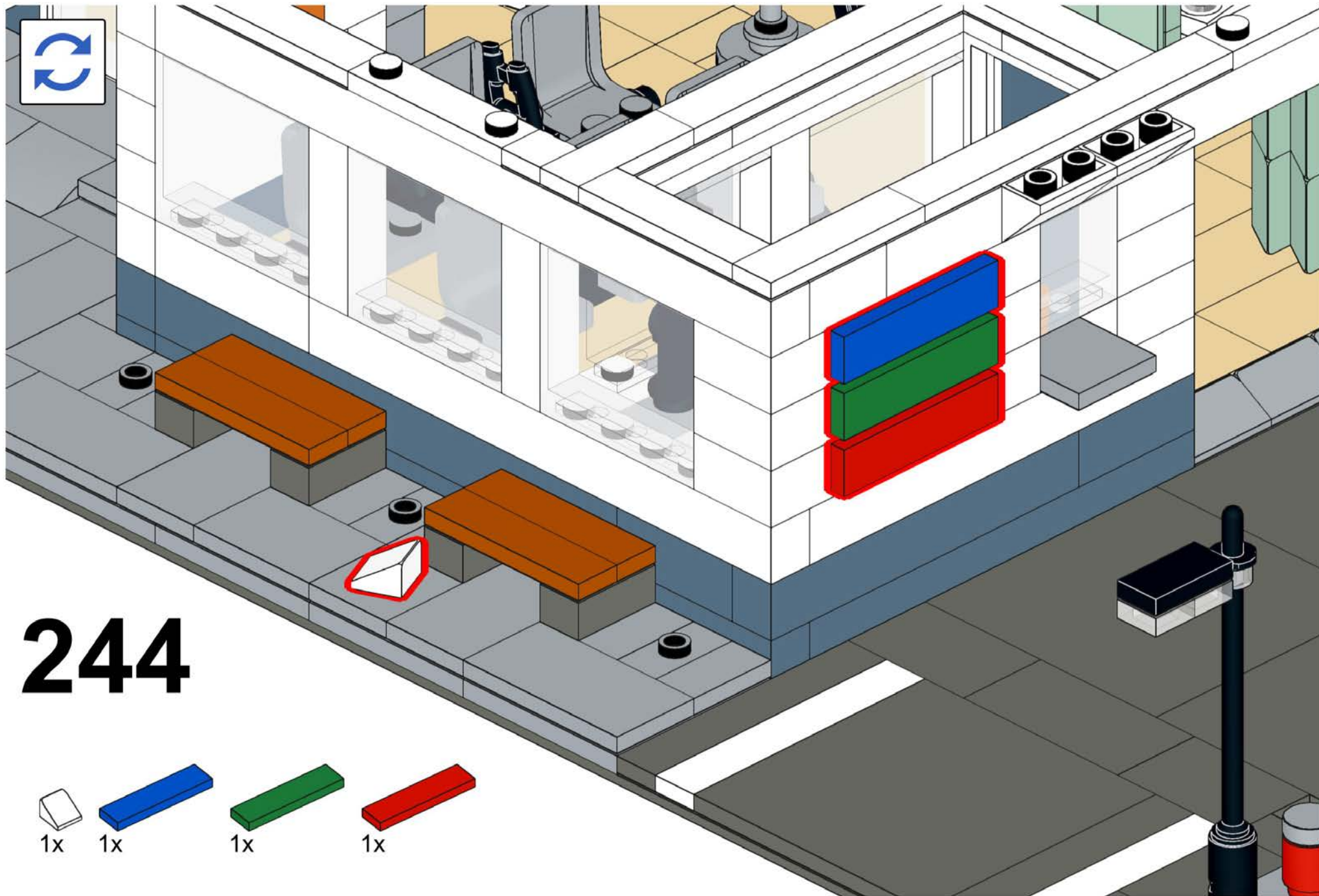

244



1x



1x



1x

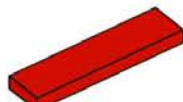

1x

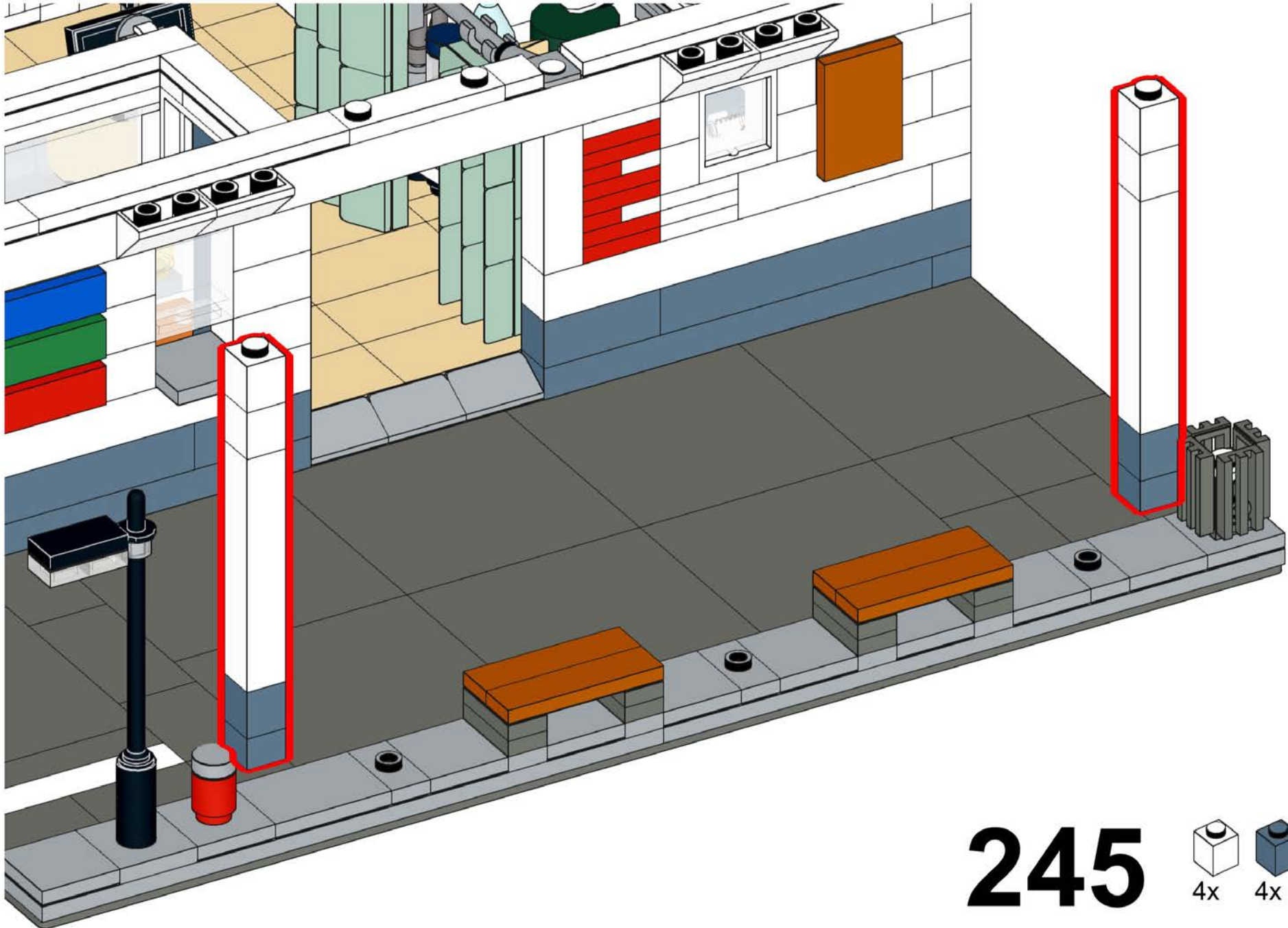

**245**



4x



4x

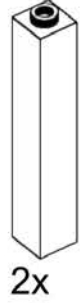

2x

# 246

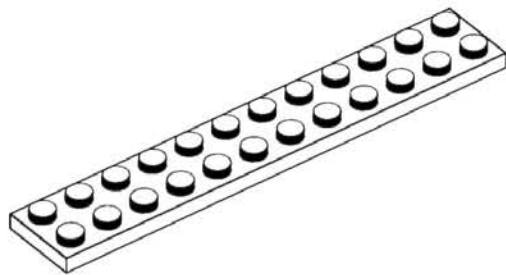

1x

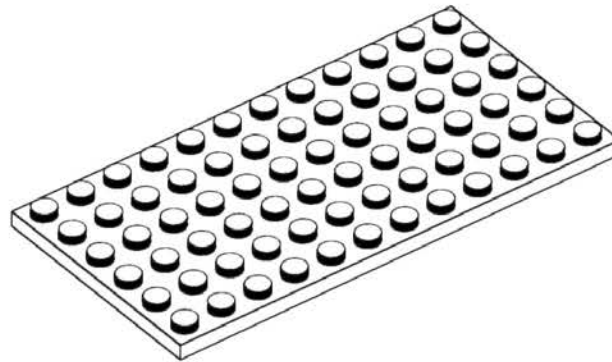

4x

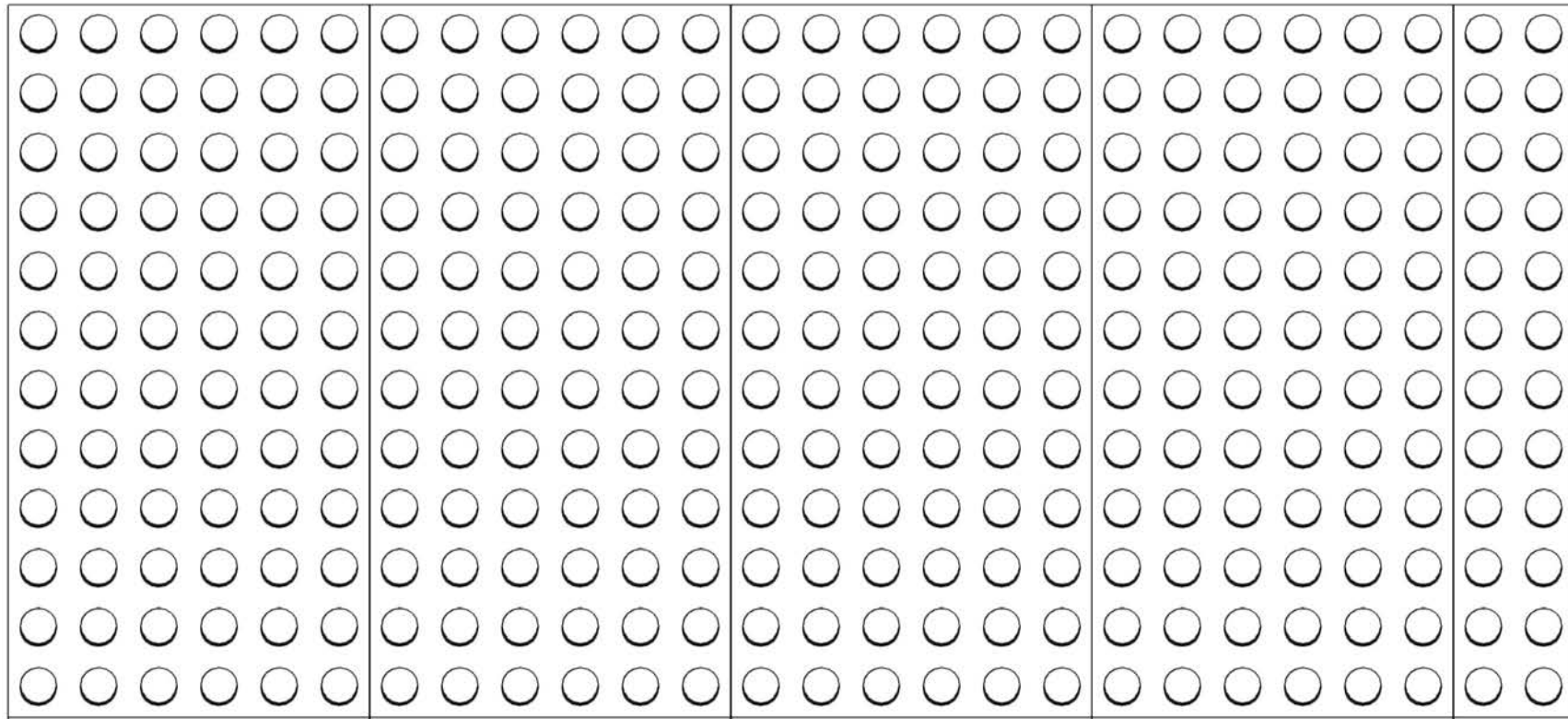
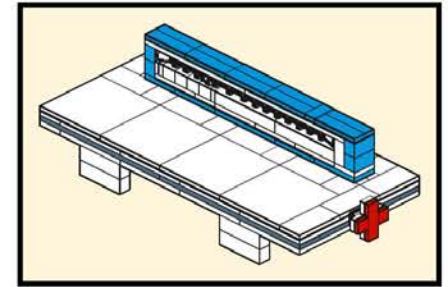

# 247

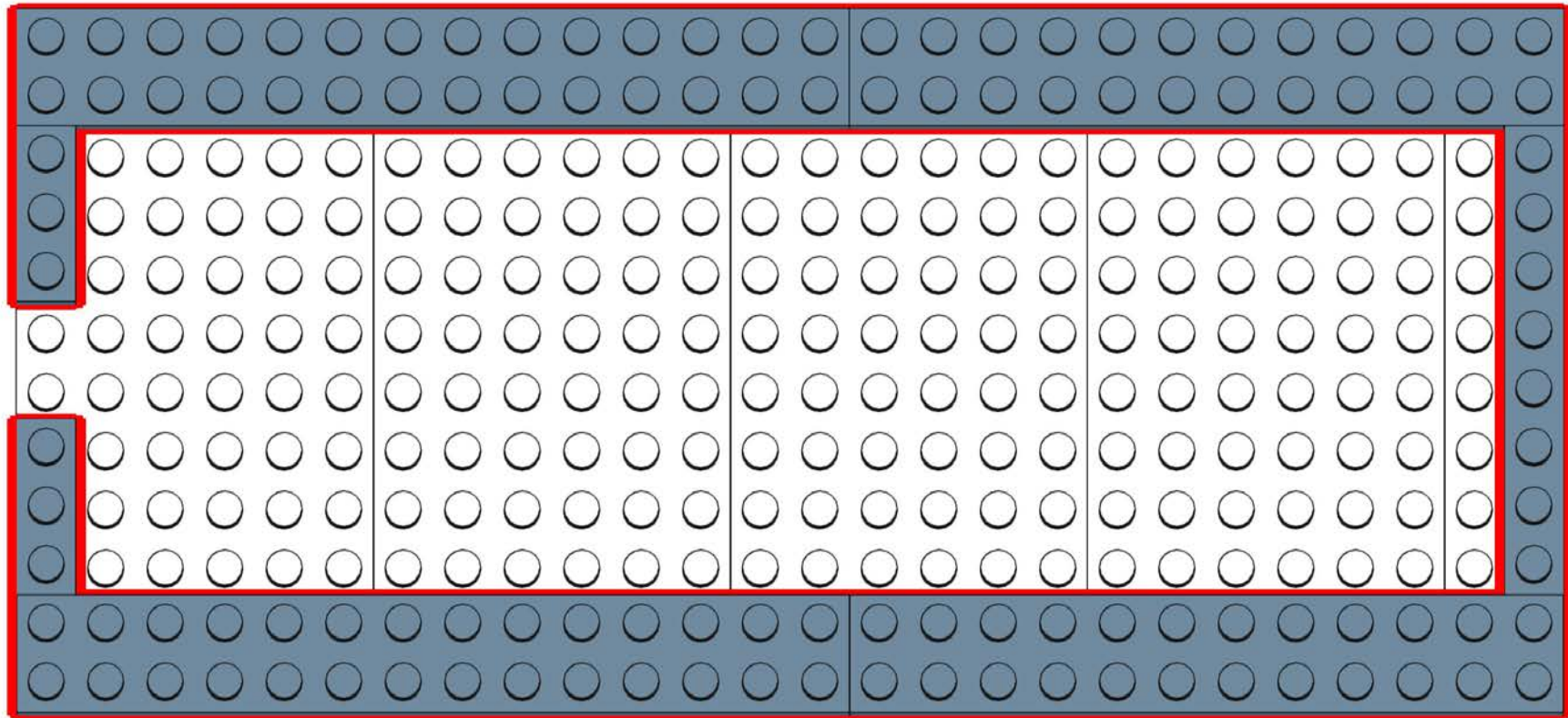
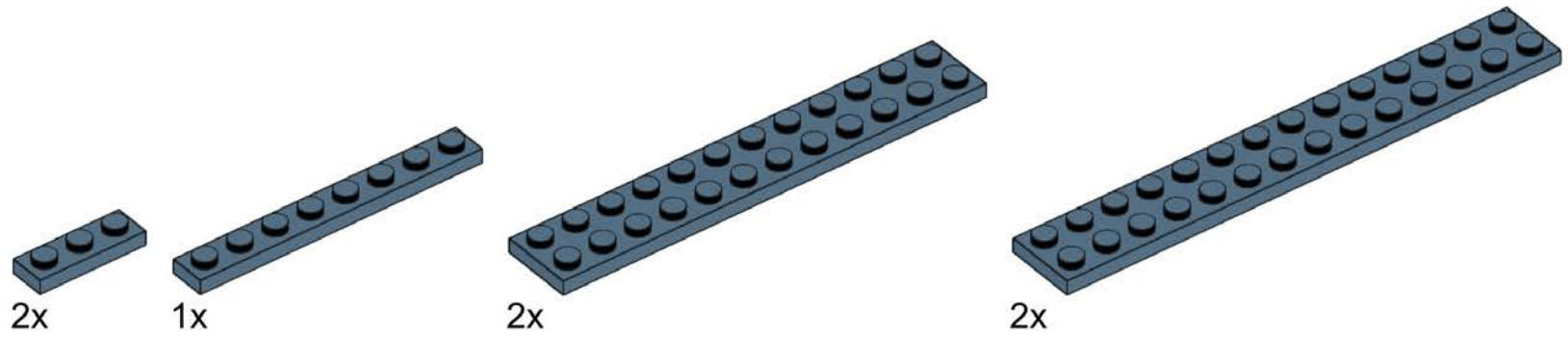



# 248



1x

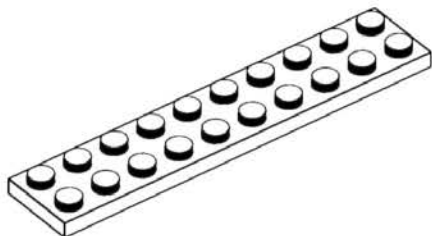

1x

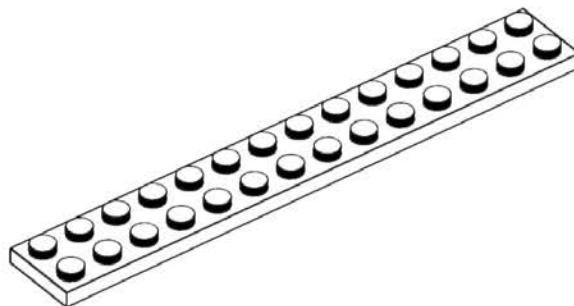

1x

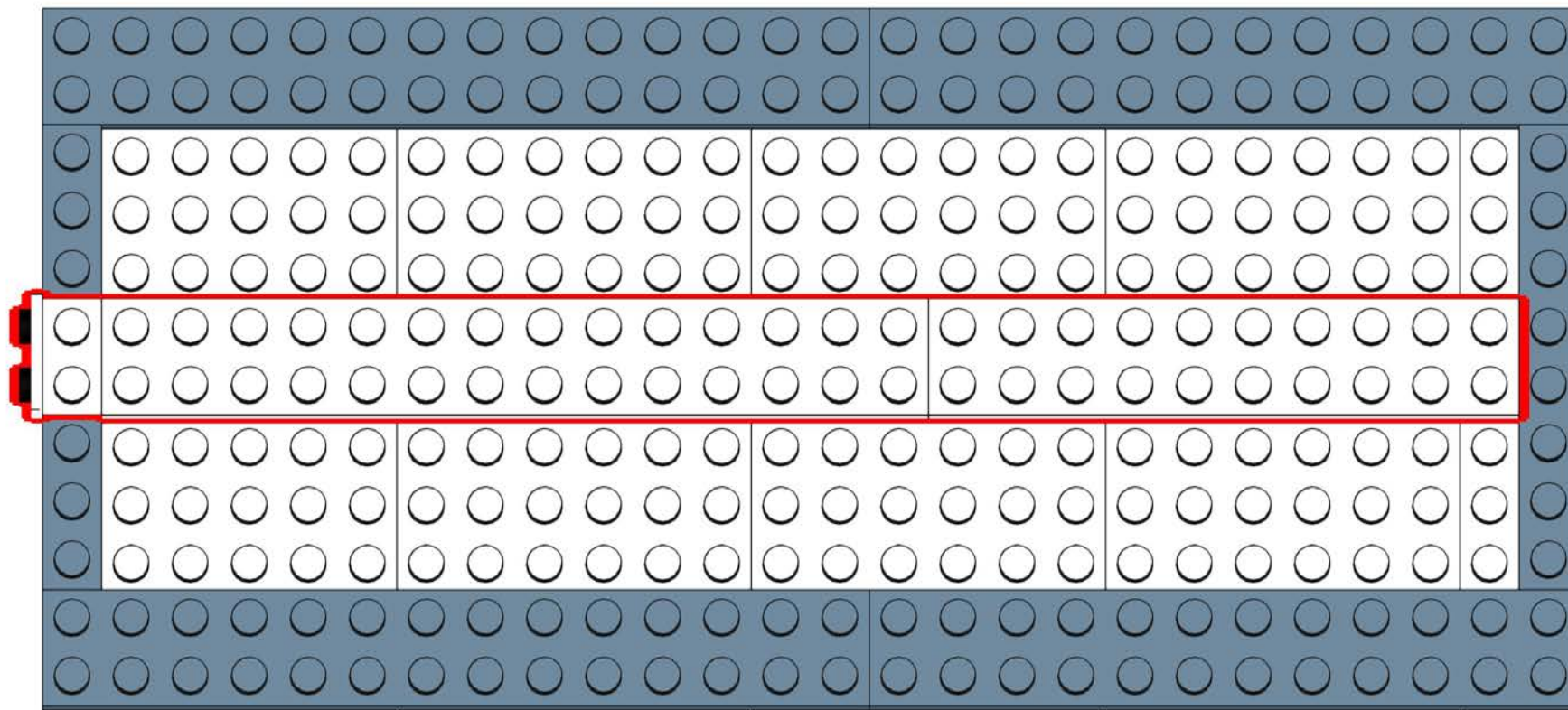

# 249

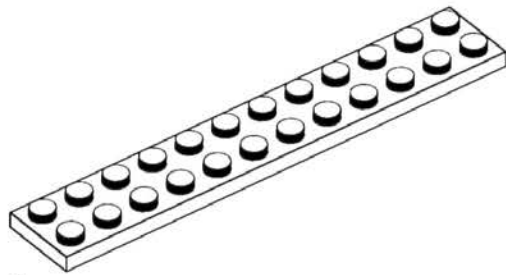

1x

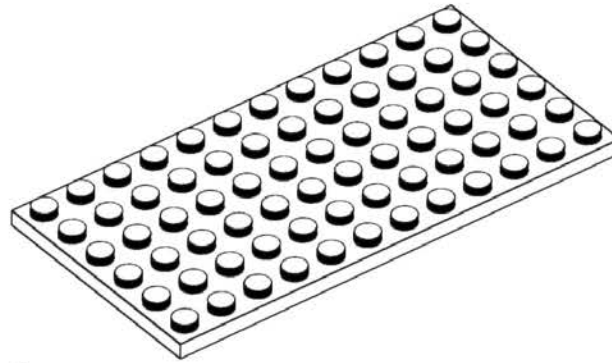

4x

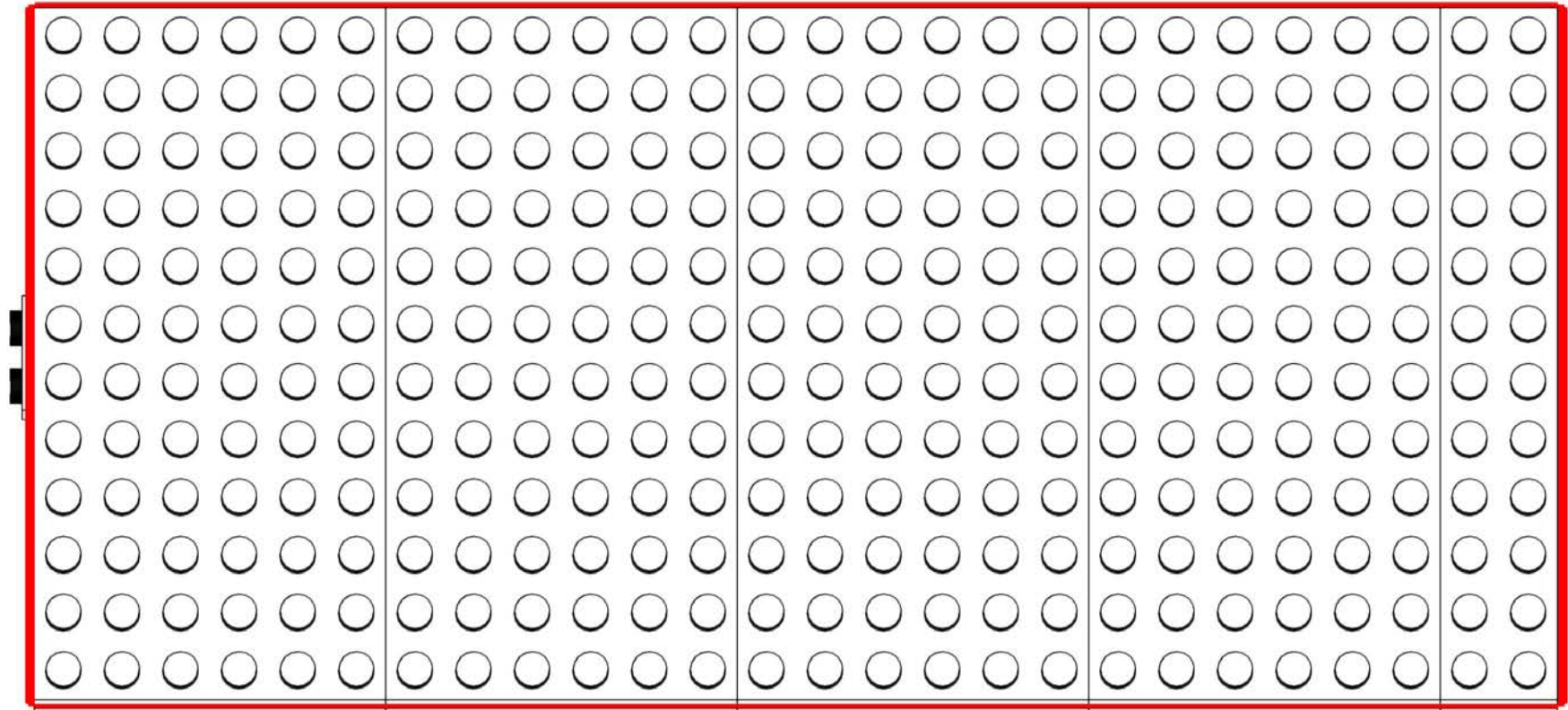



# 251

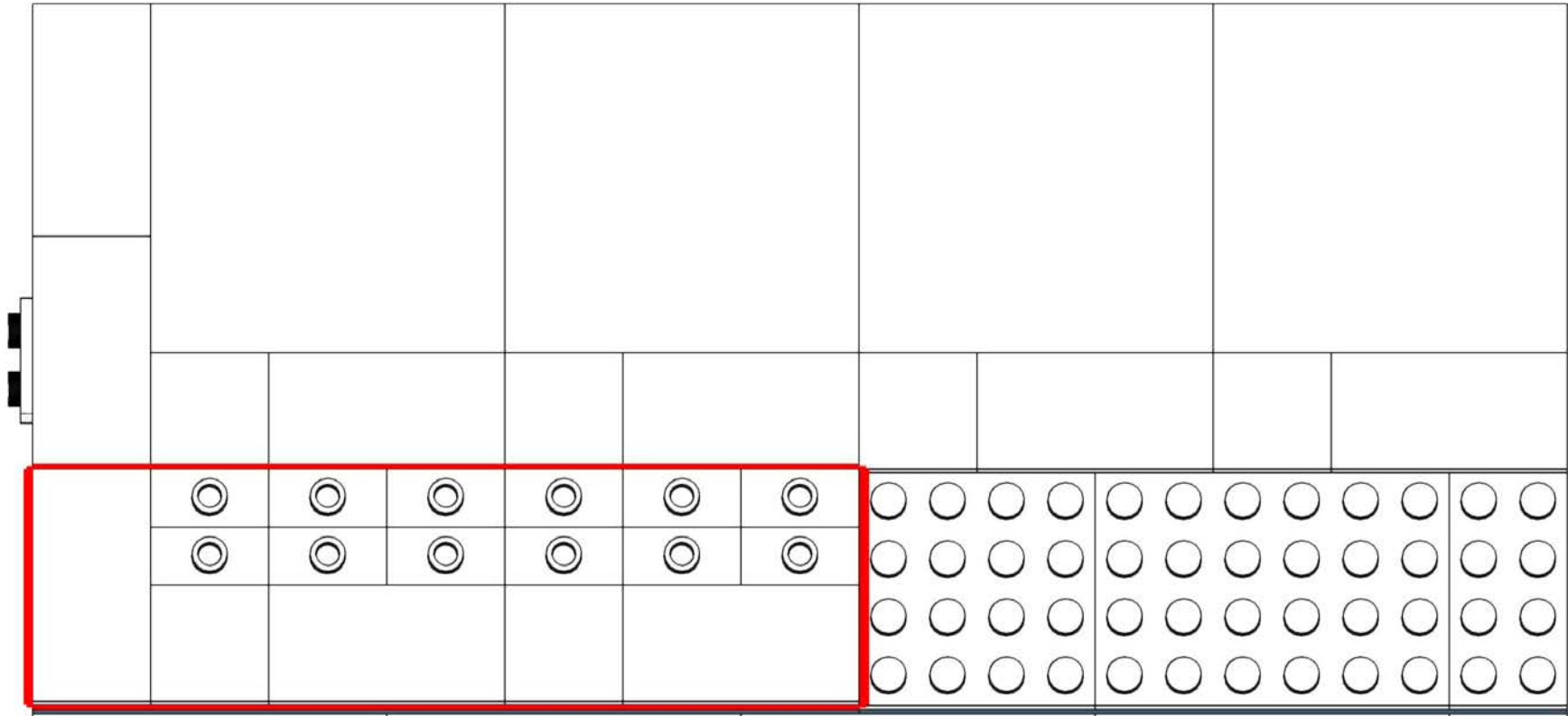
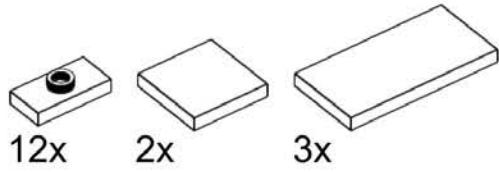

# 252

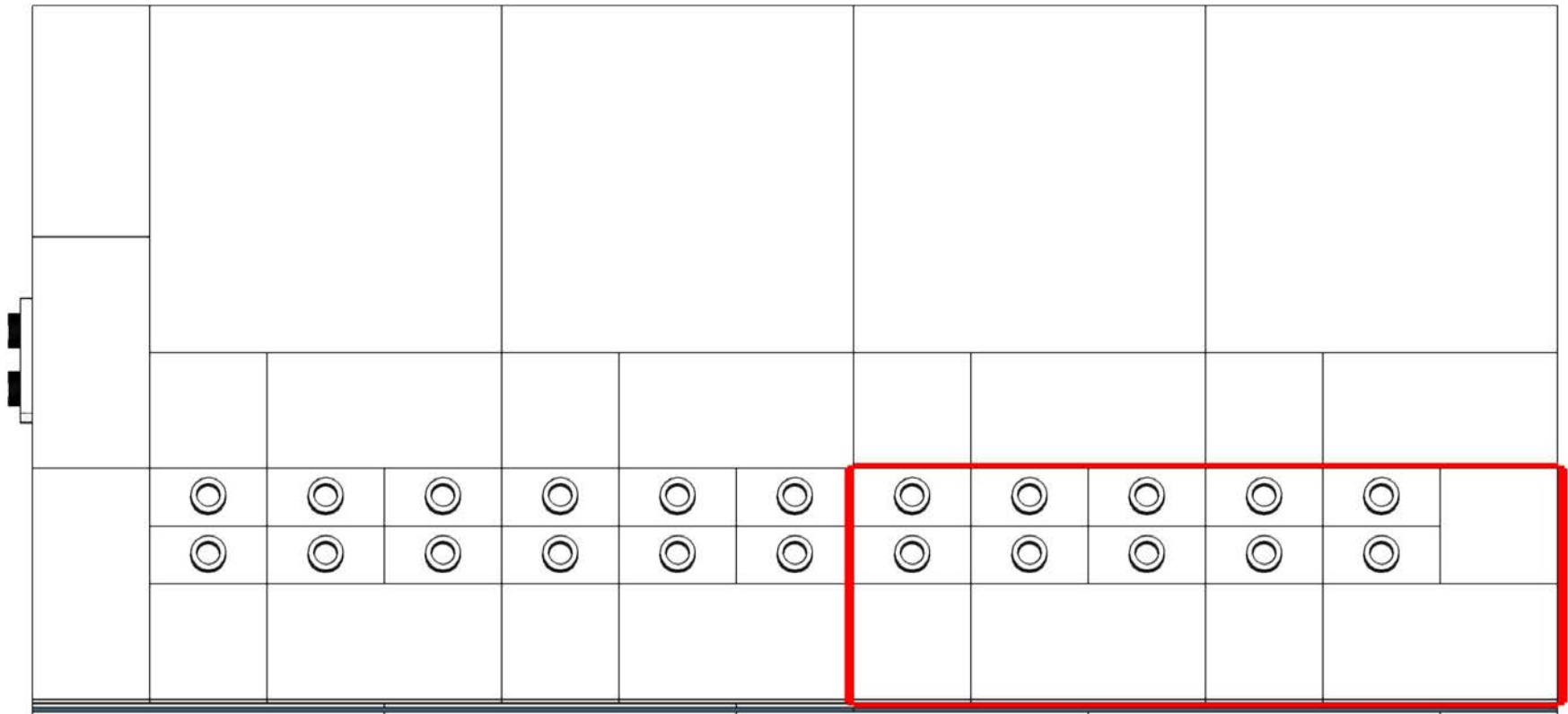
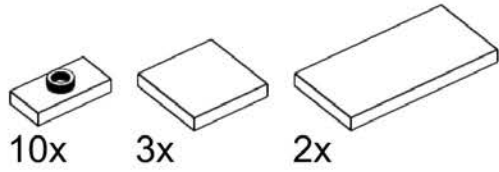

# 253

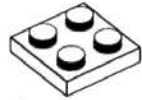

1x

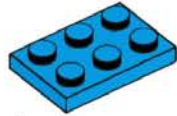

1x

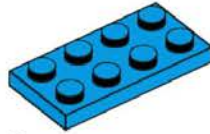

3x

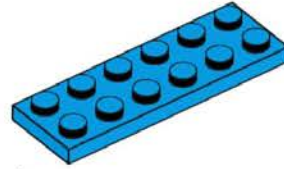

1x

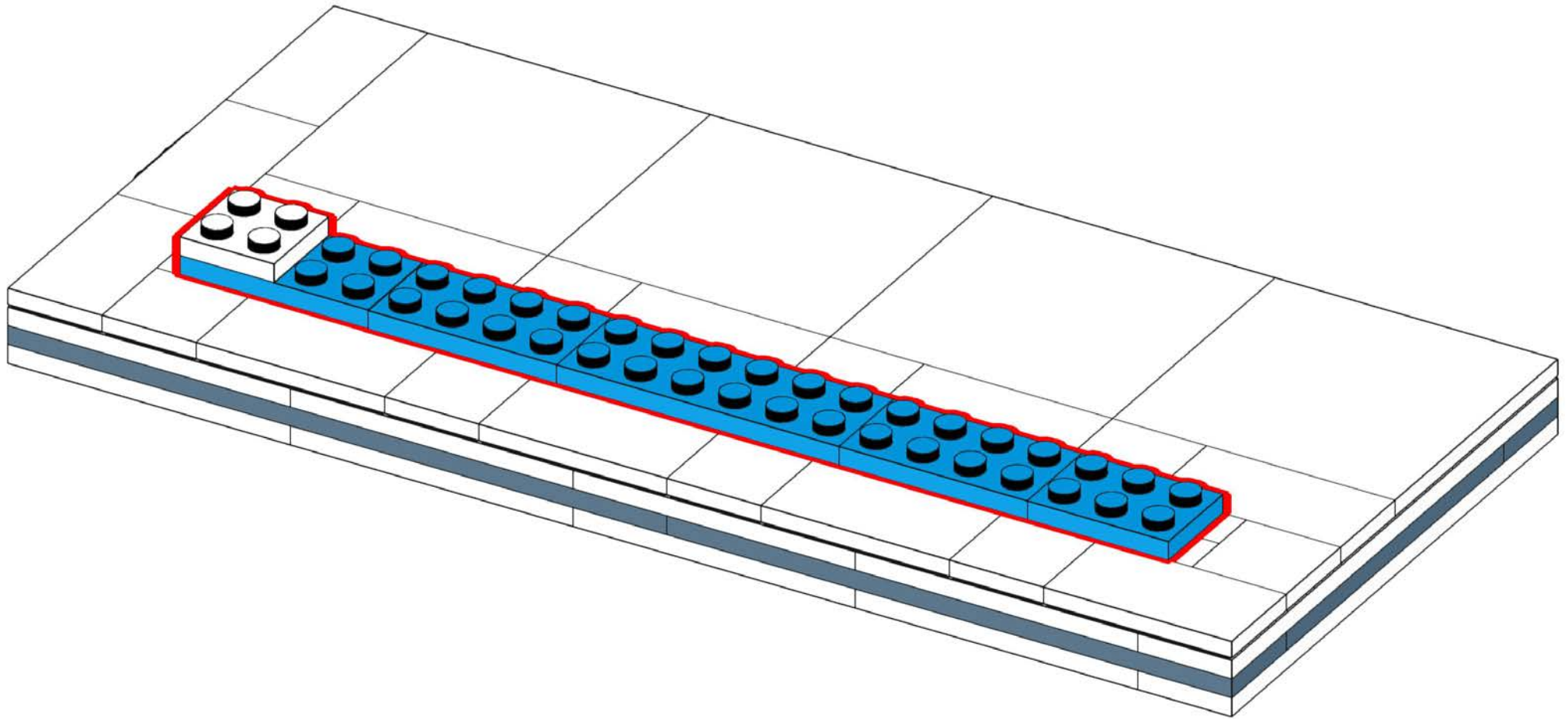

# 254

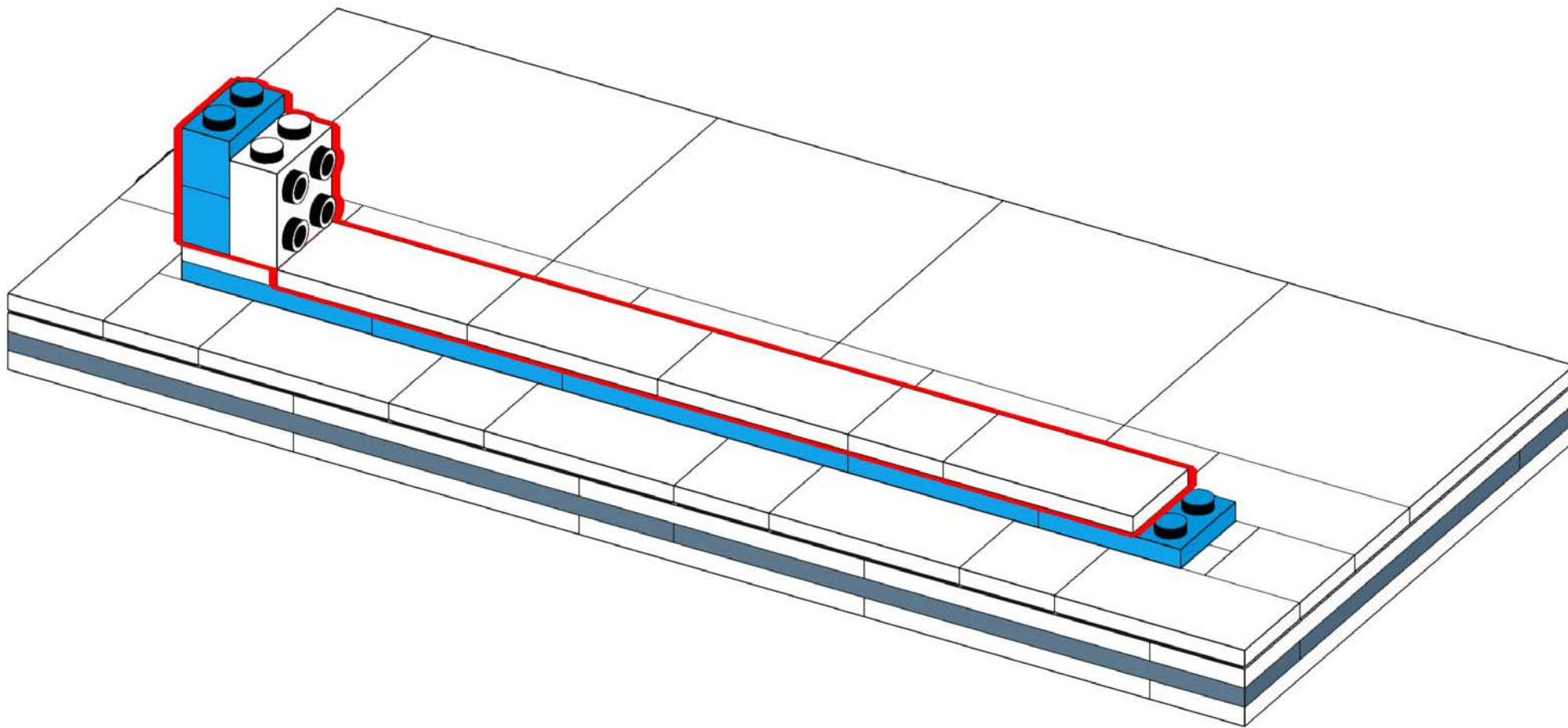
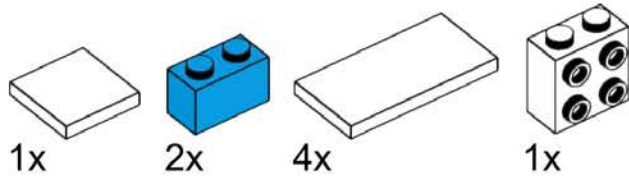

# 255

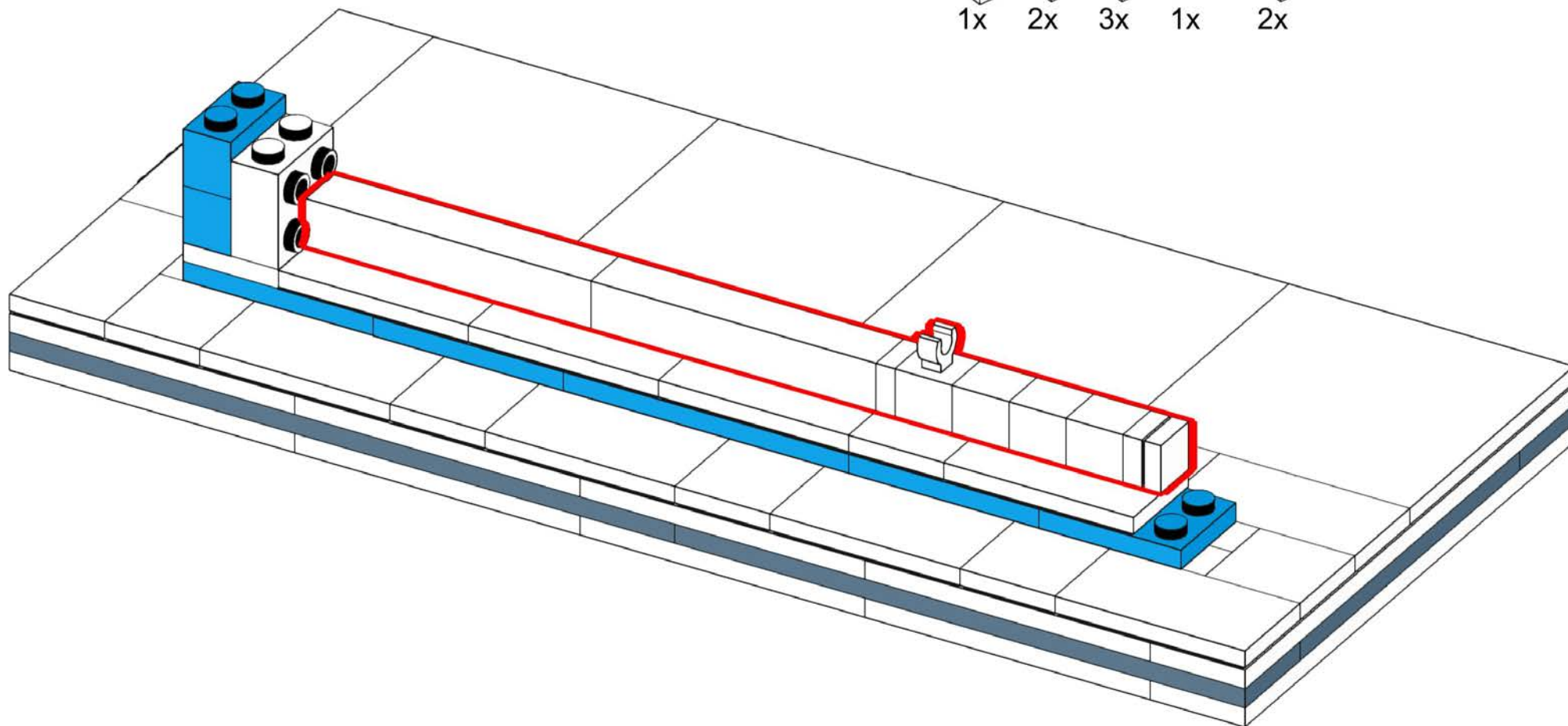
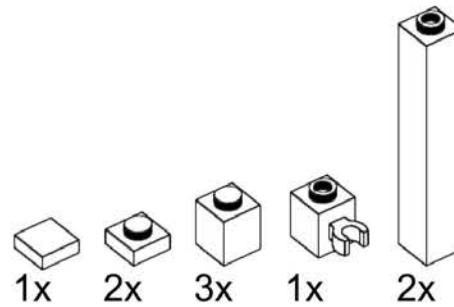

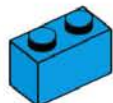
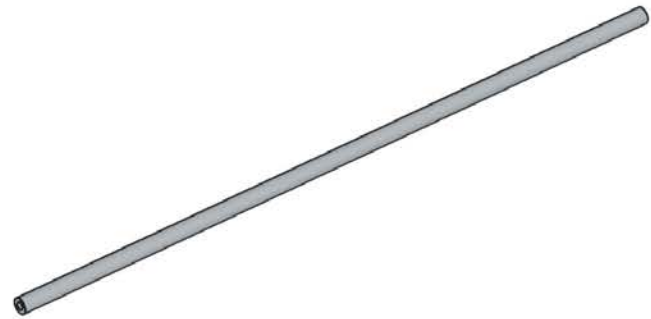

# 256

- 2x 
- 2x 
- 1x 

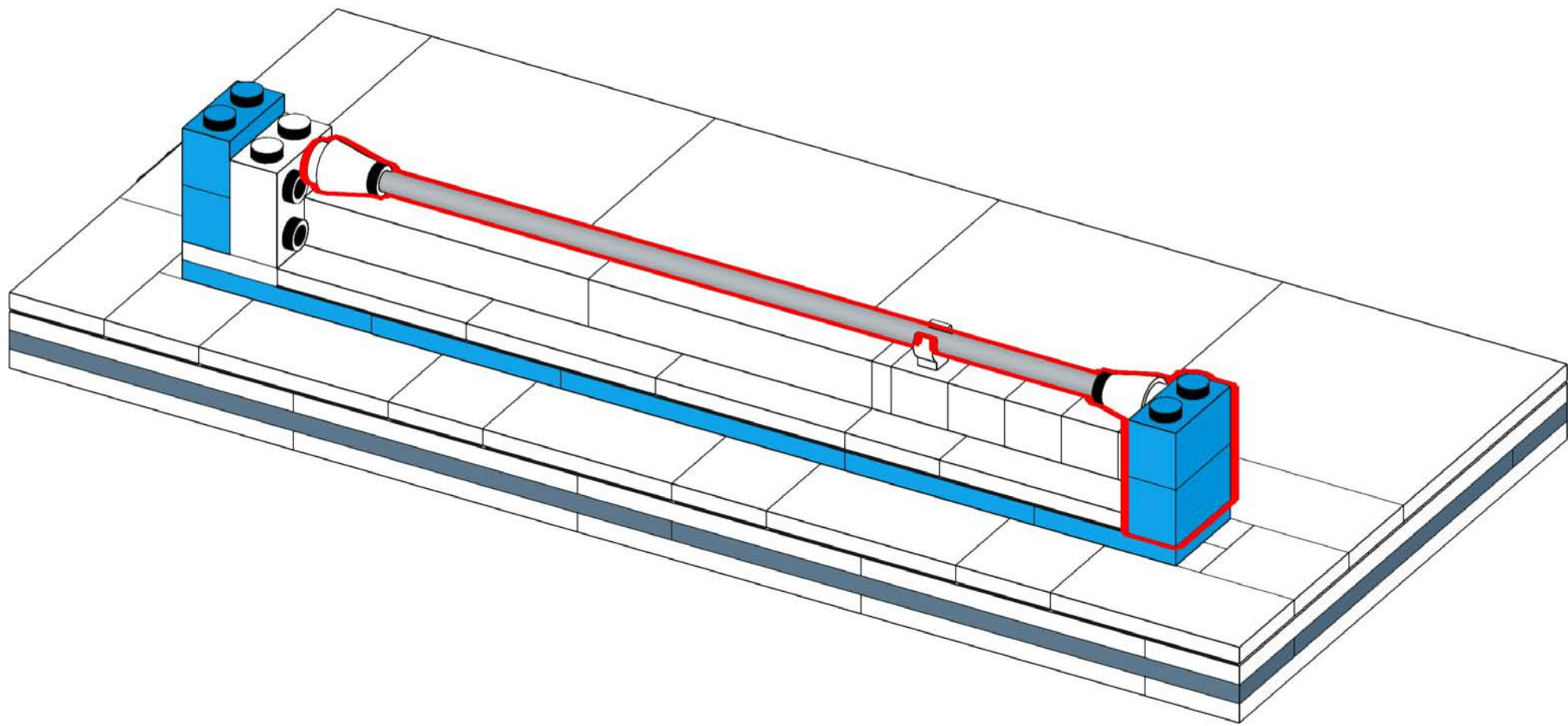

# 257

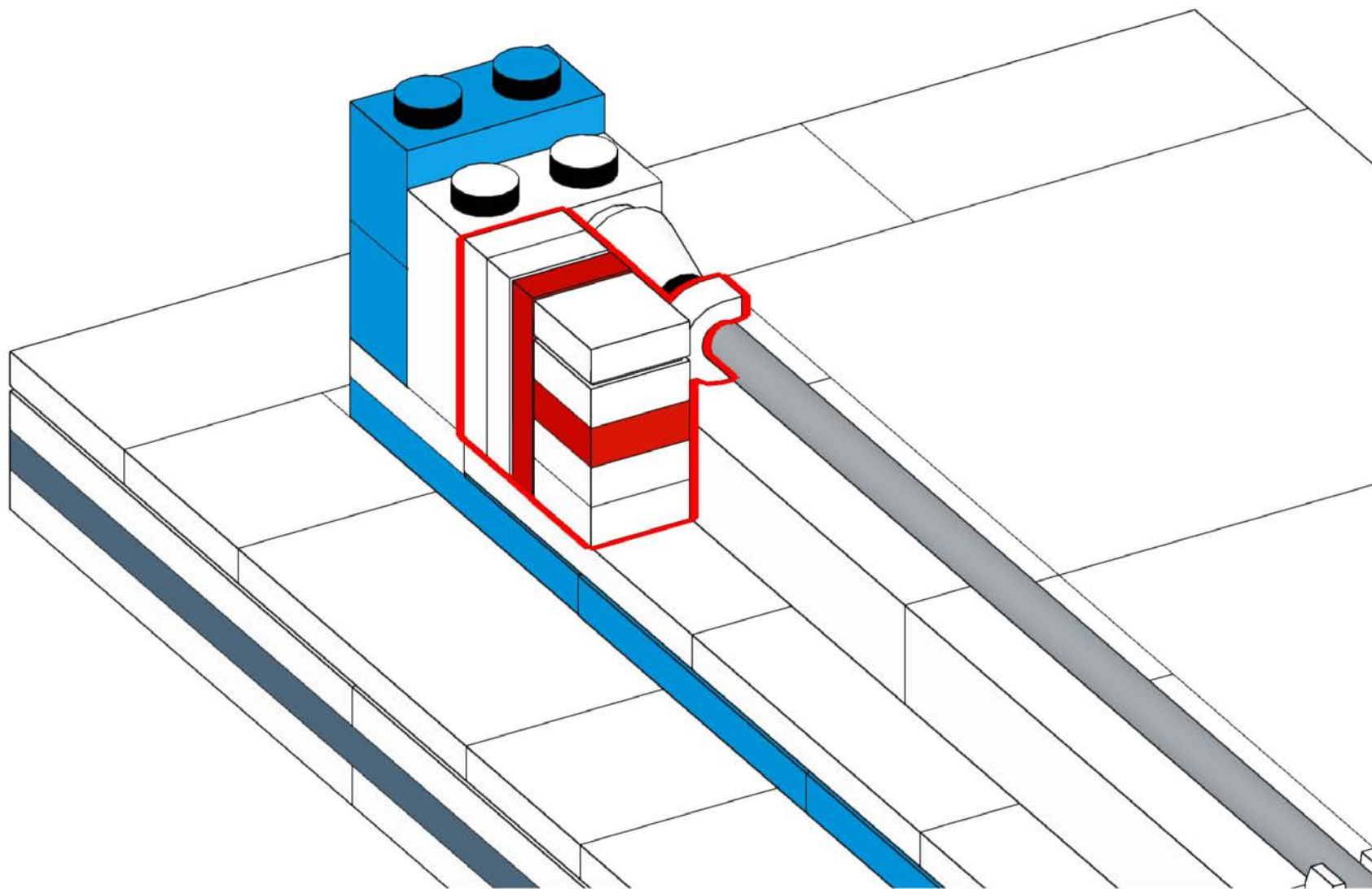
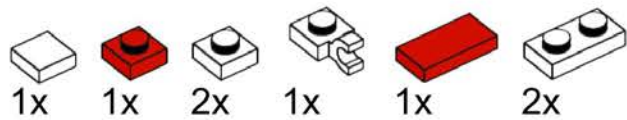

# 258



1x



1x



1x



1x

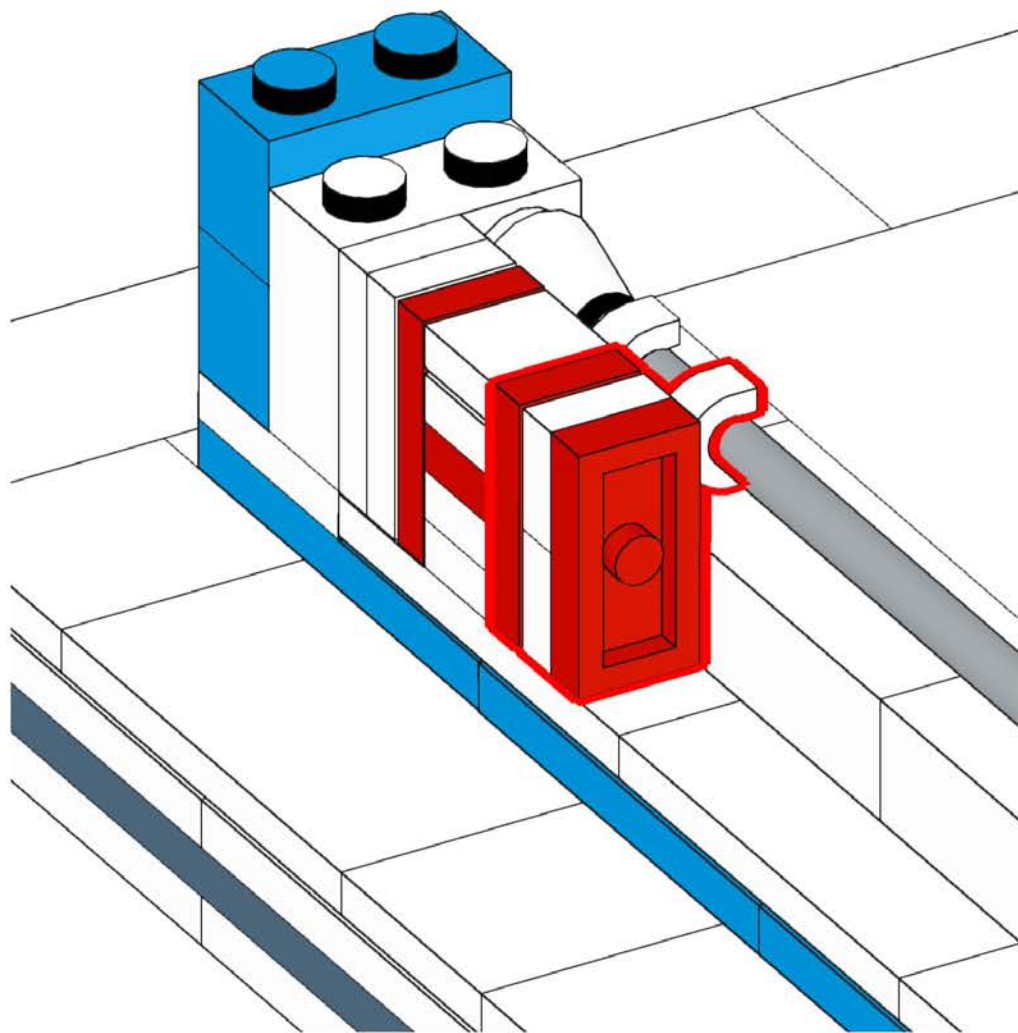

# 259



1x



1x



2x



1x

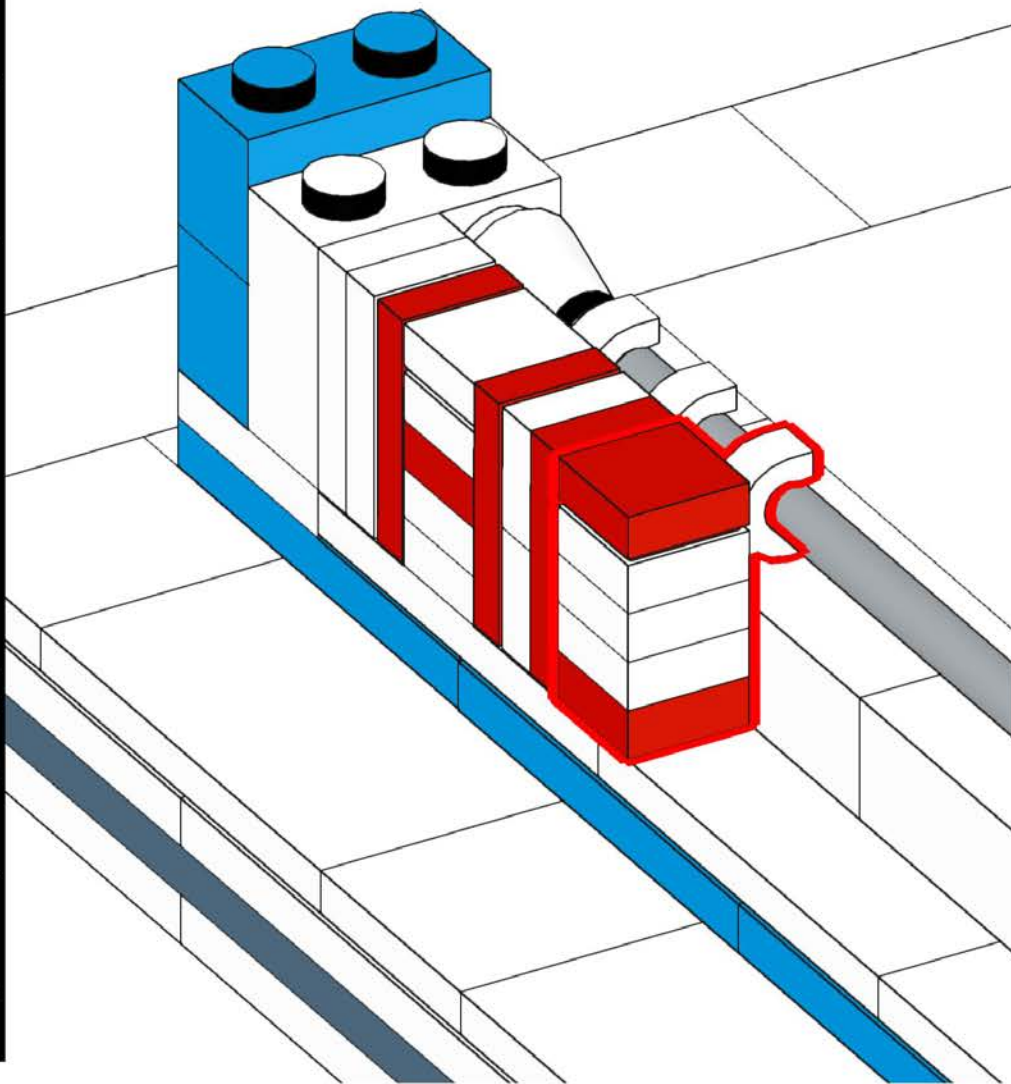

# 260

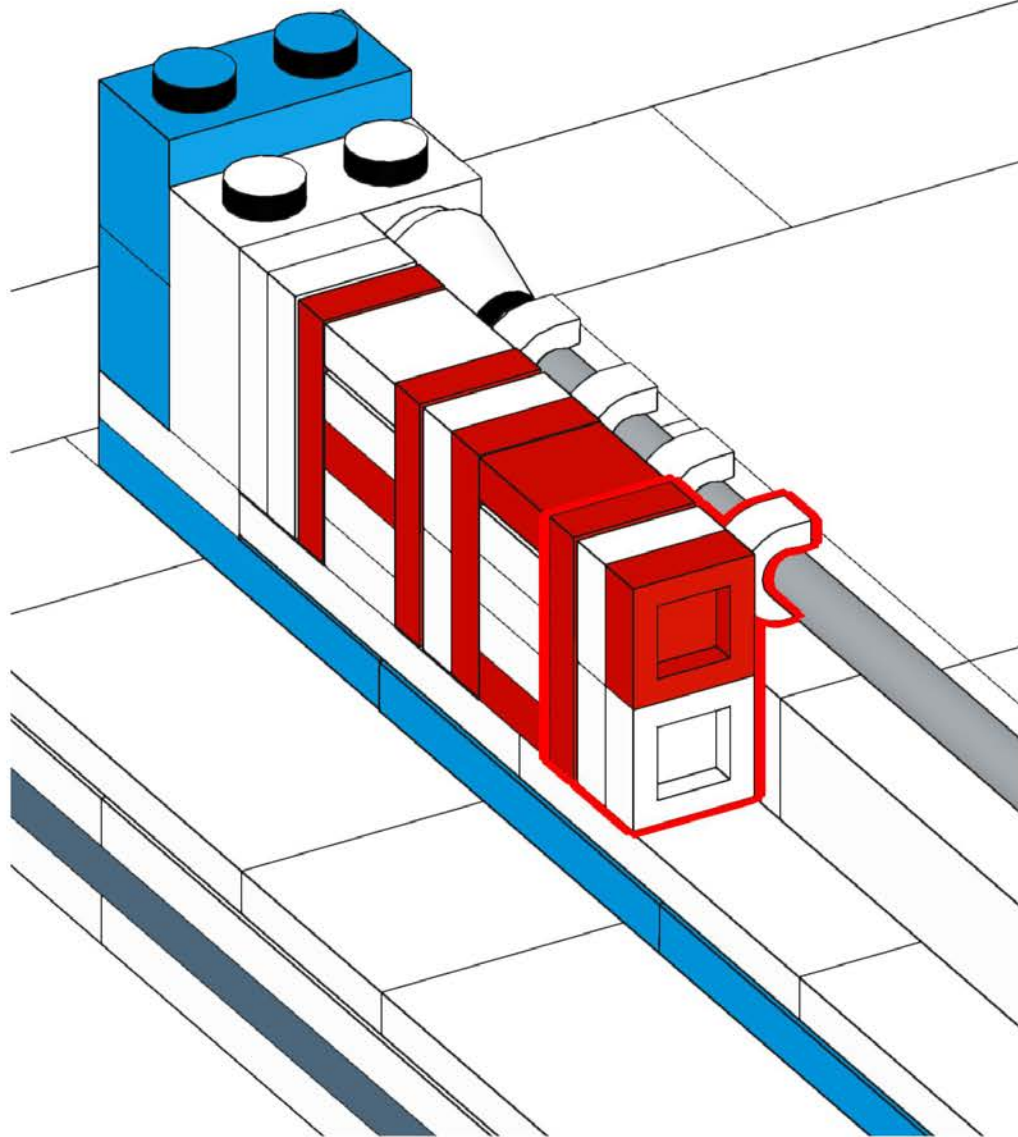
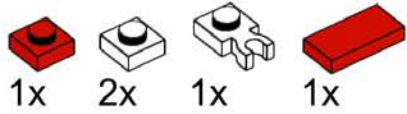

# 261

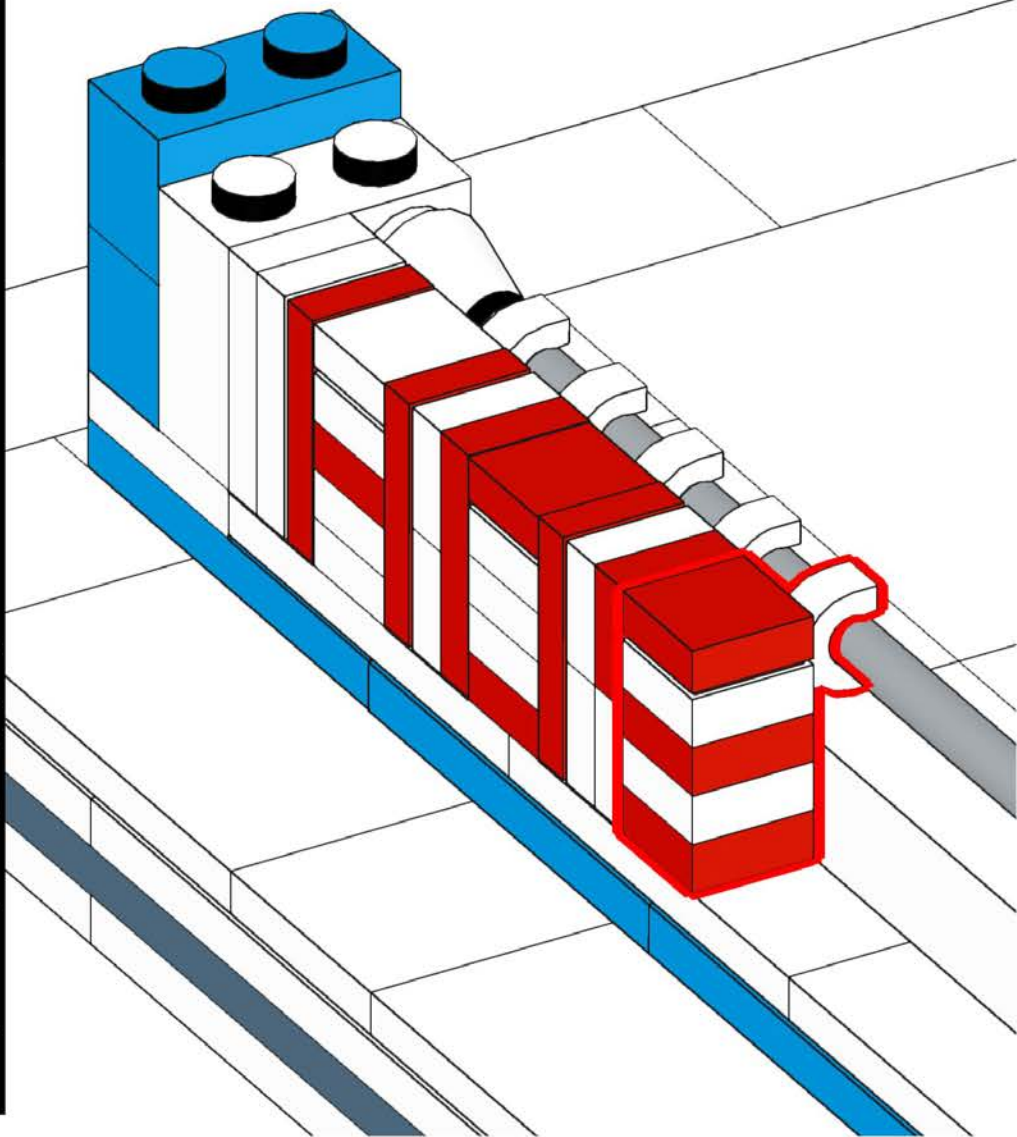
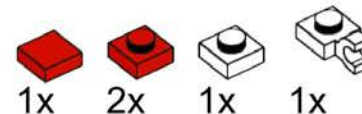

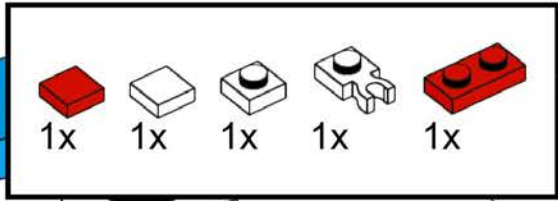

# 262

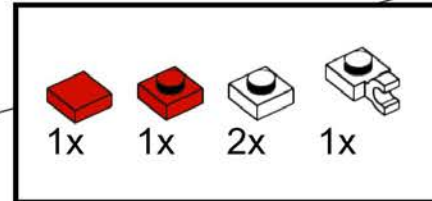
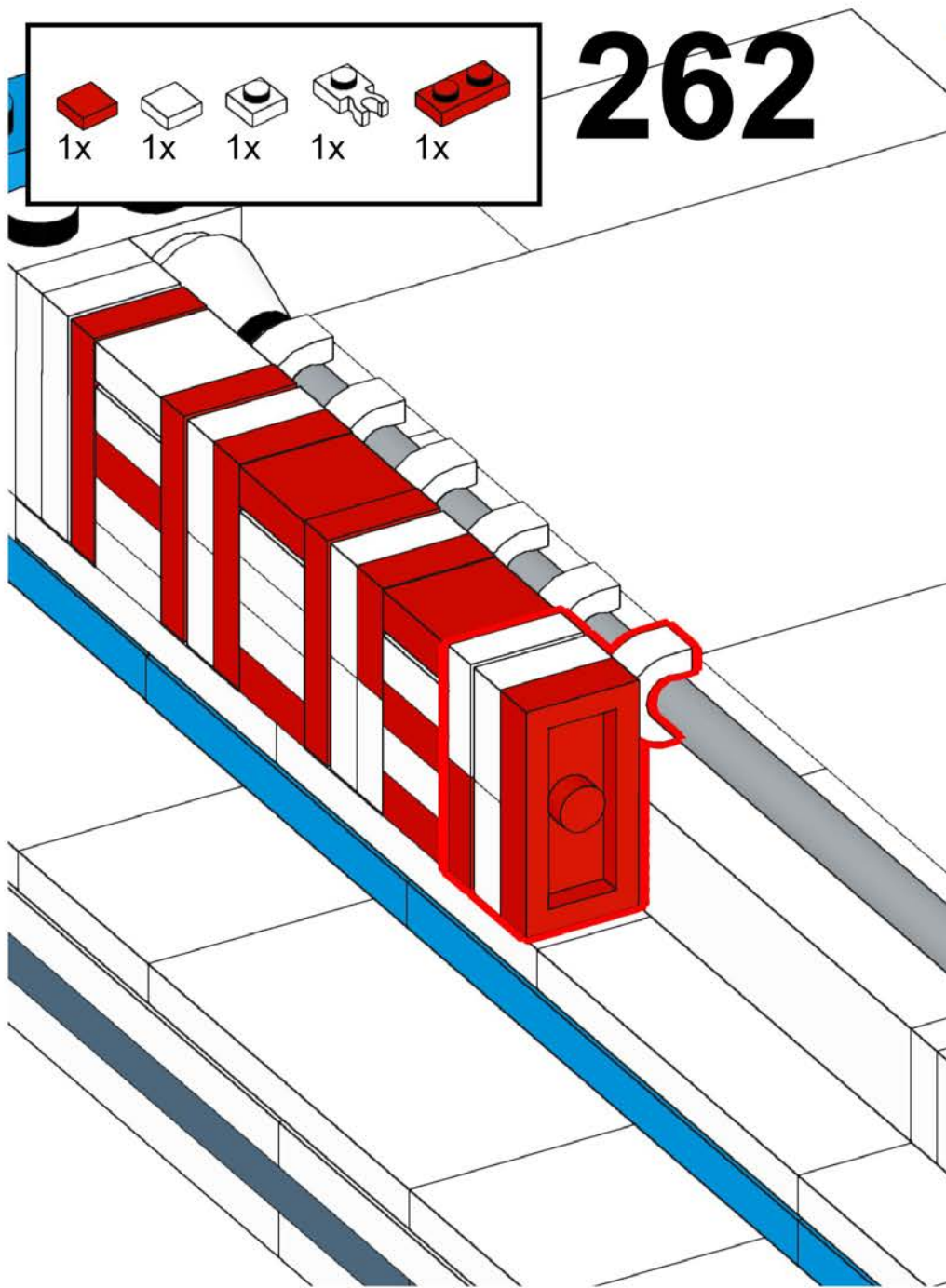

# 263

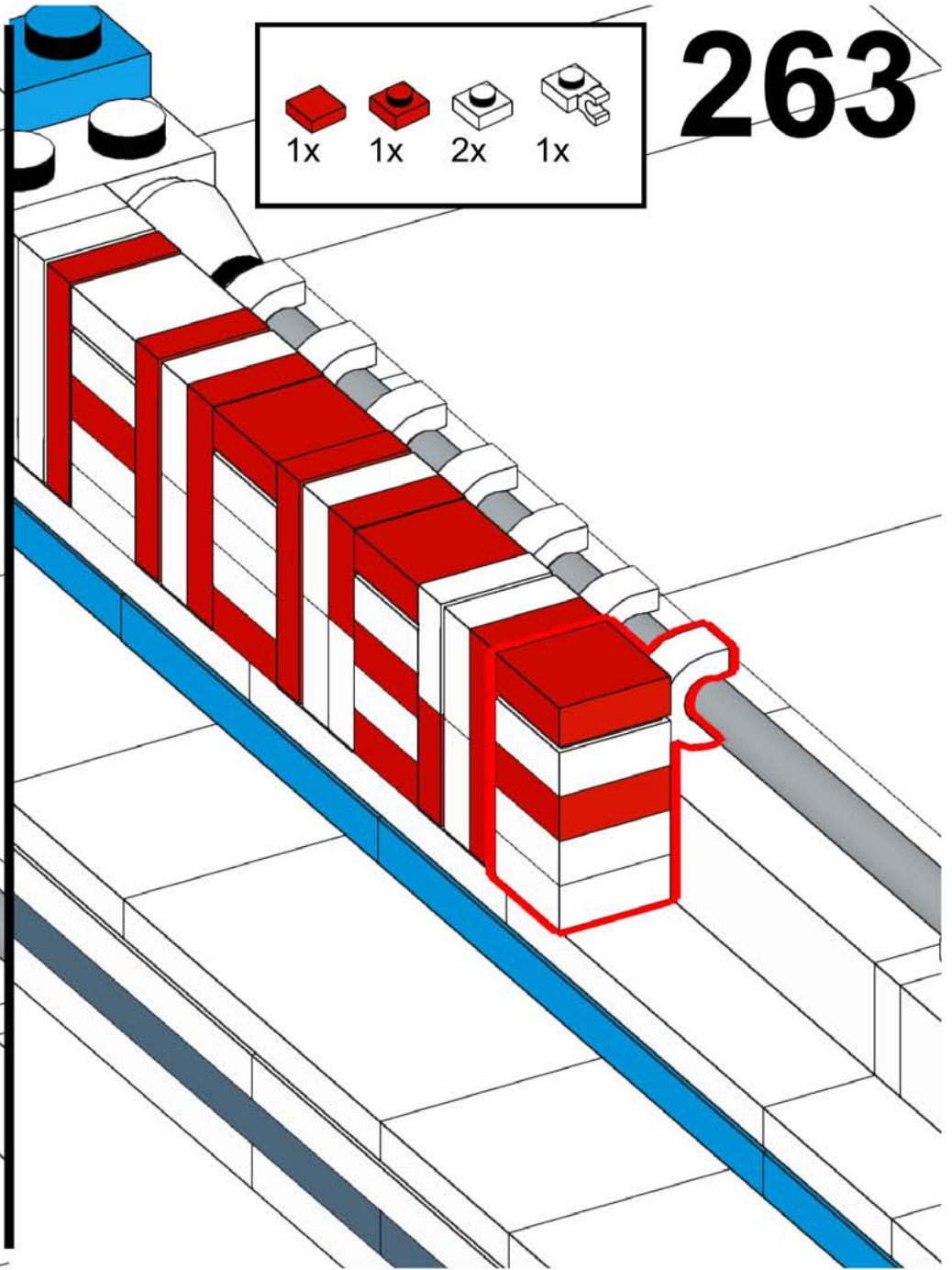

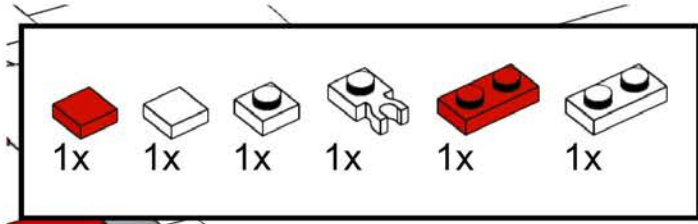

# 264

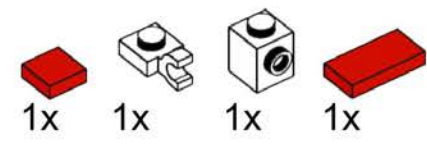
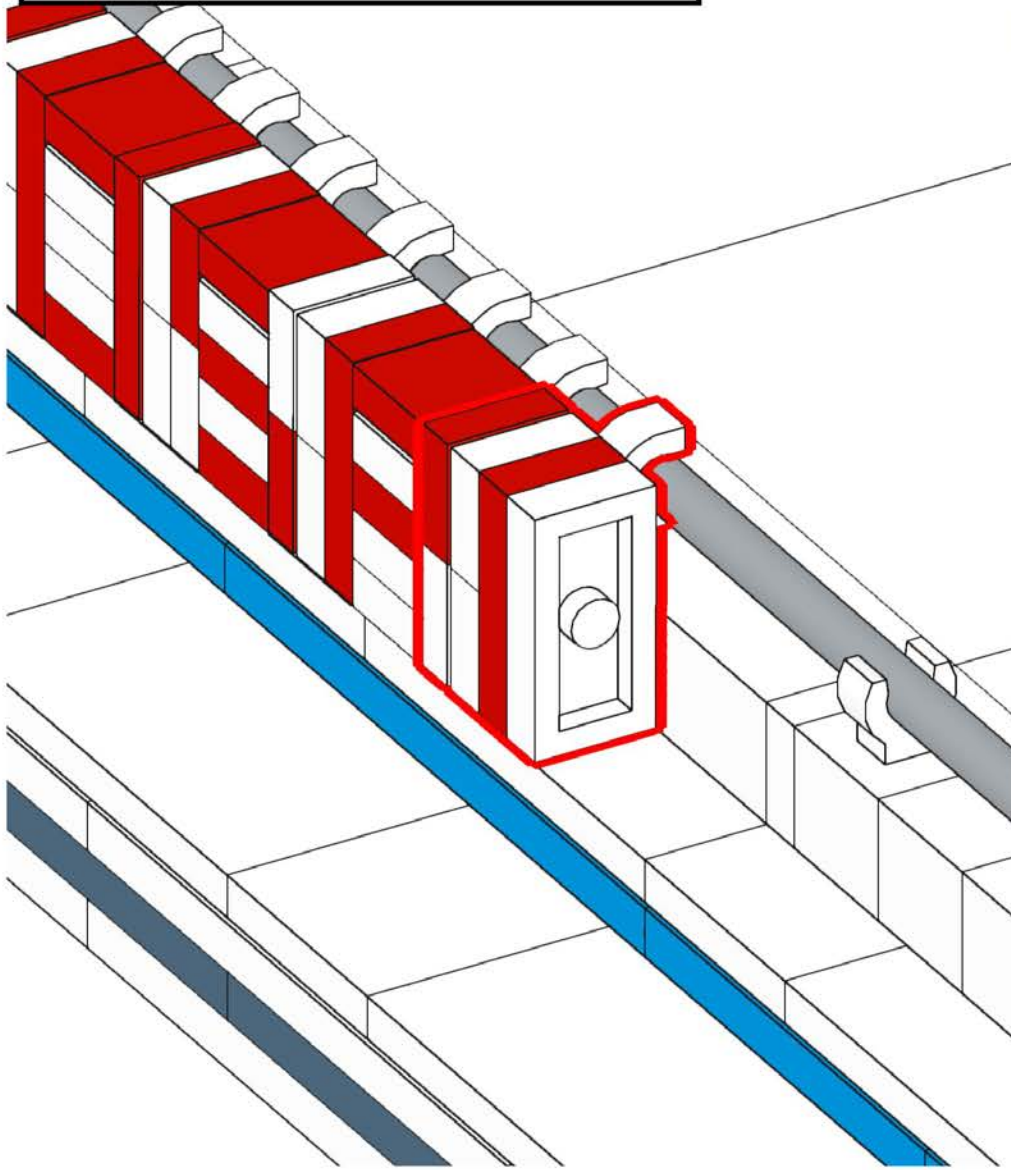

# 265

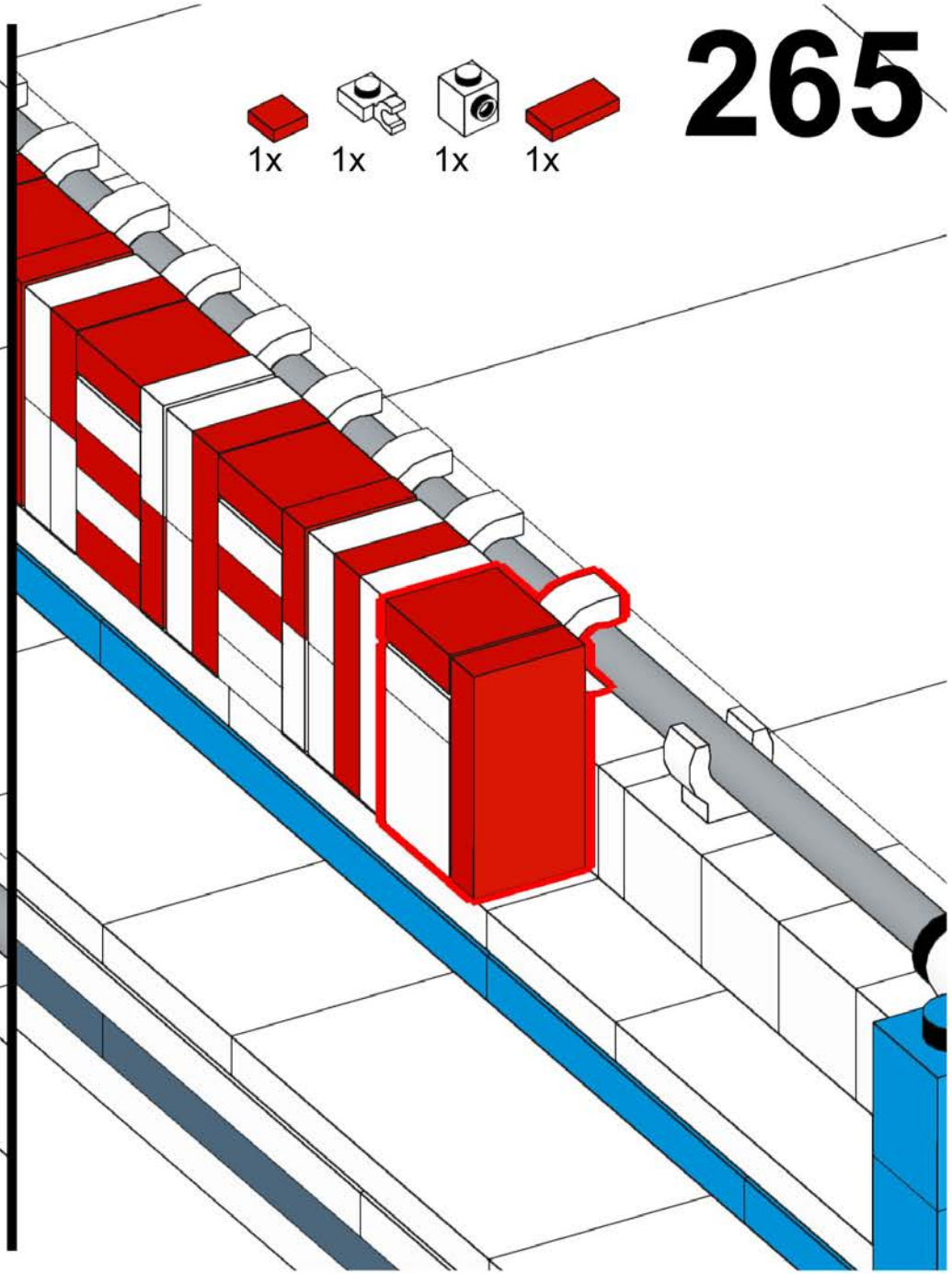

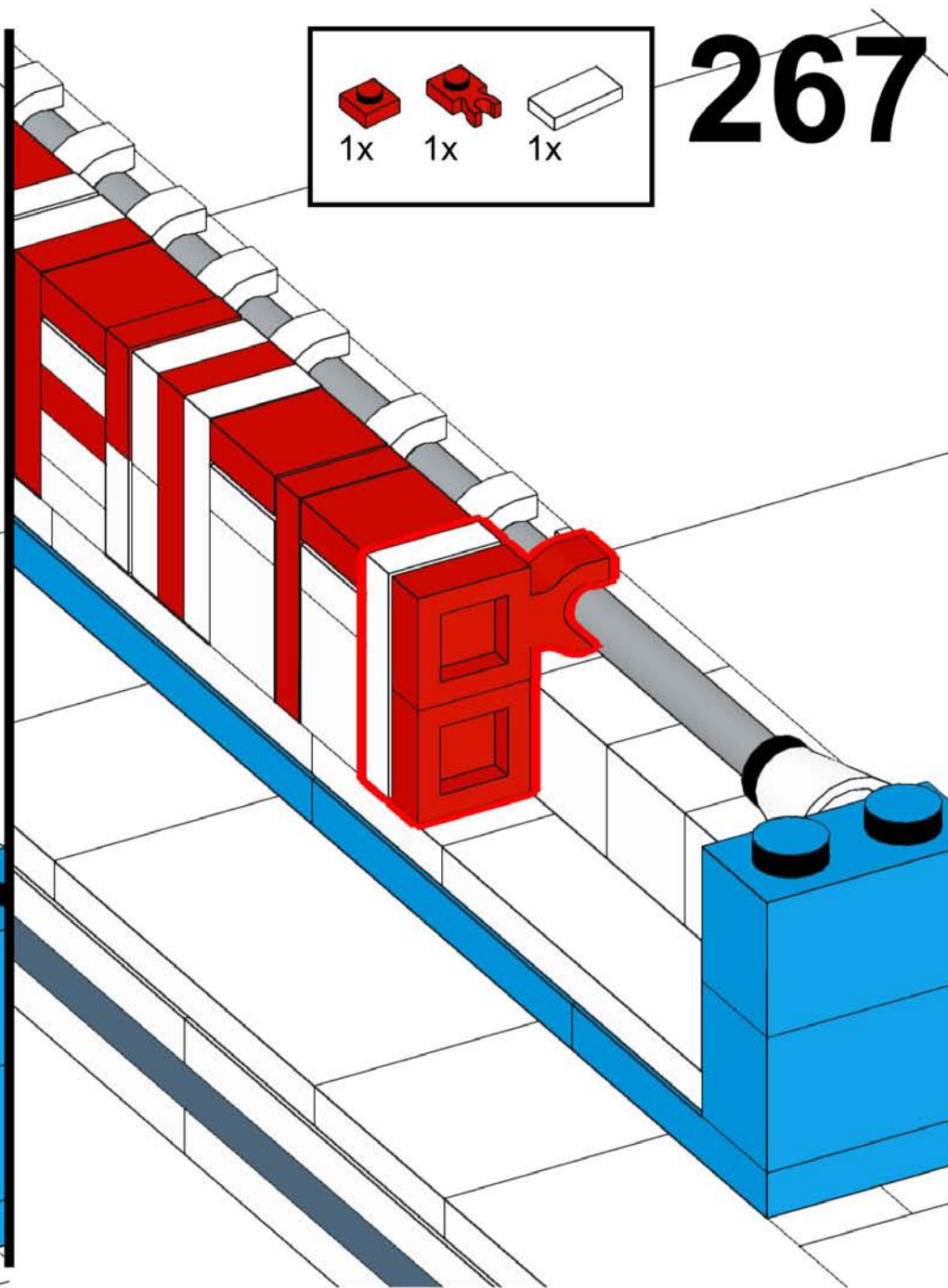
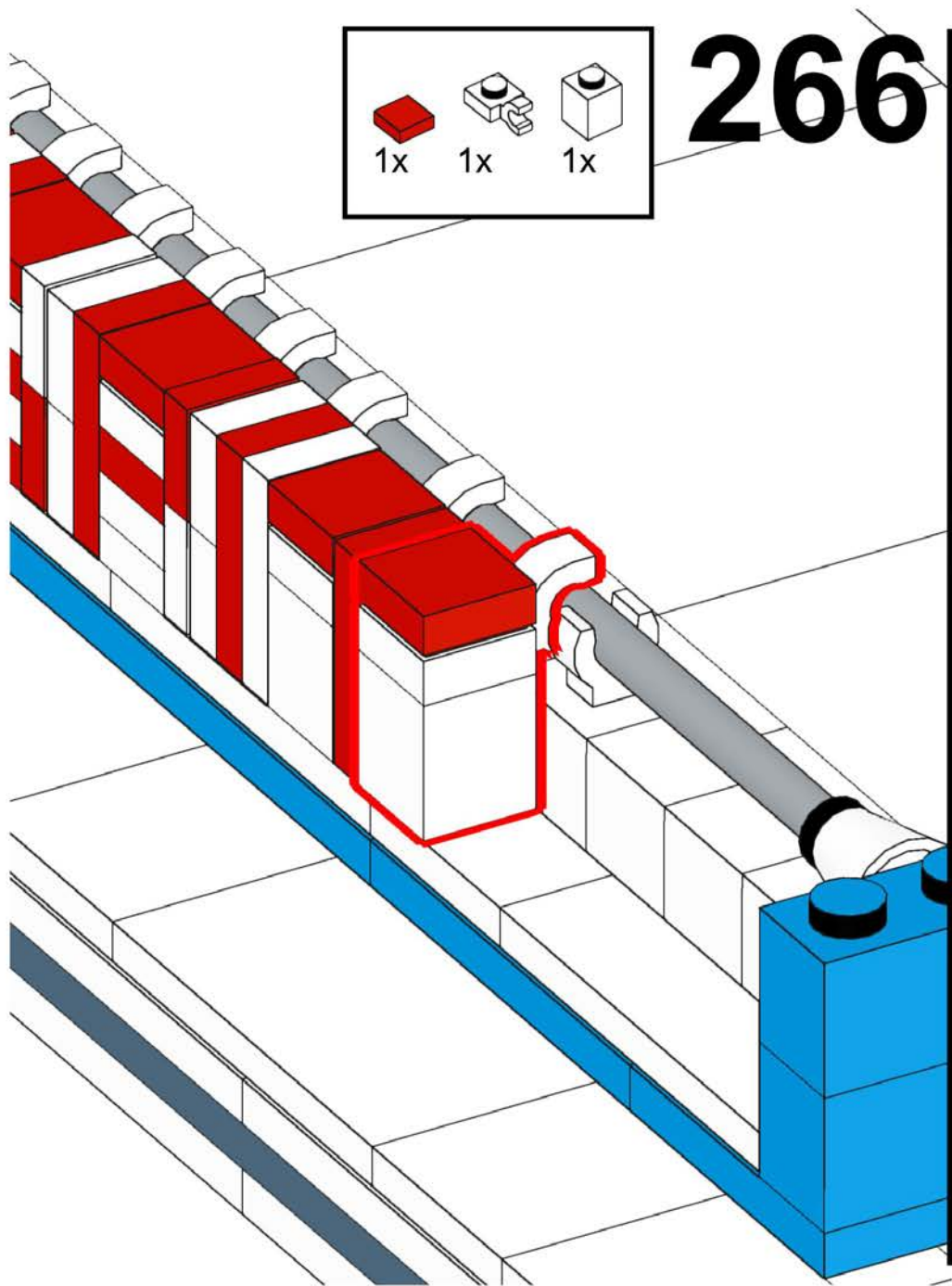

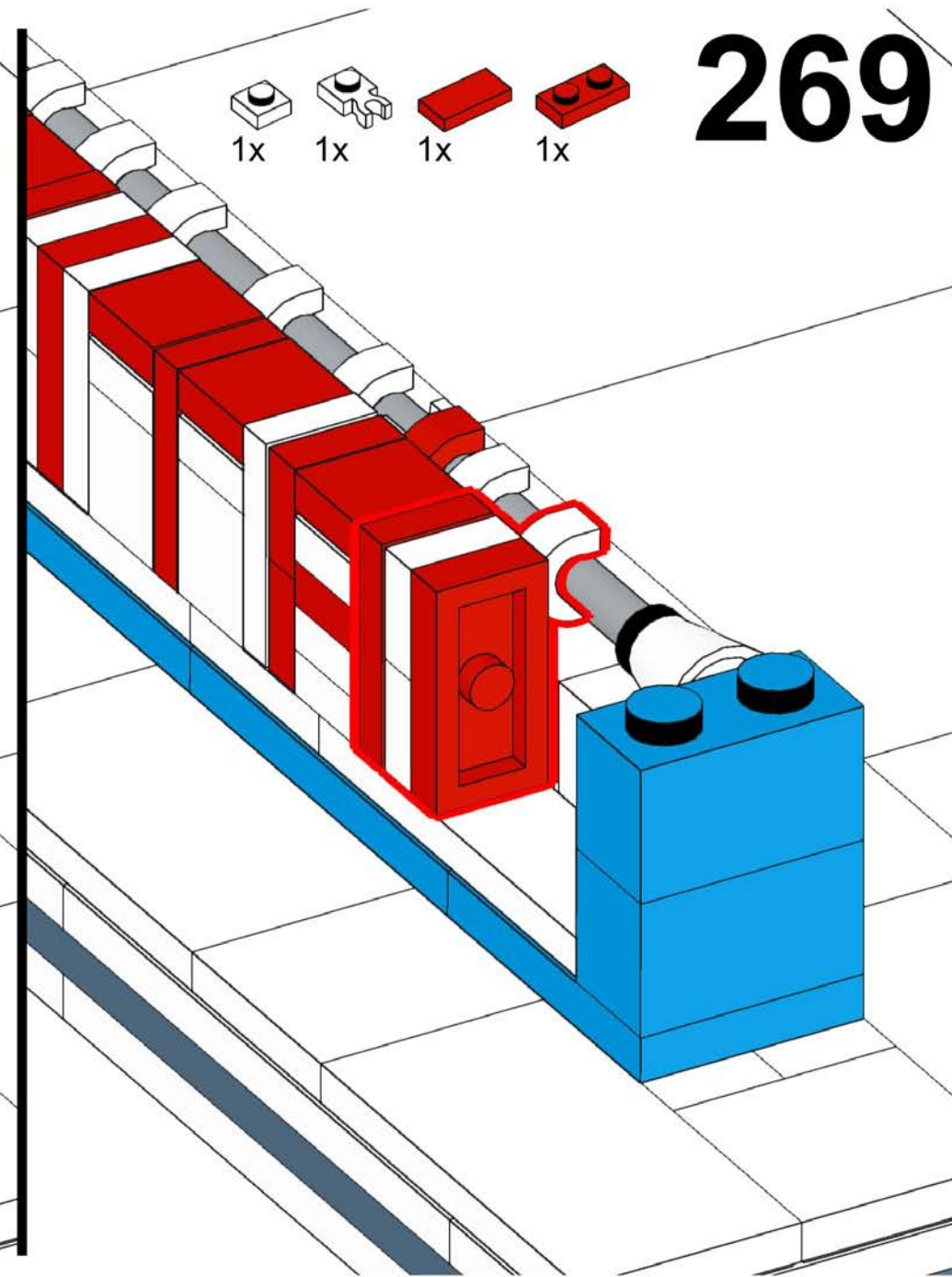
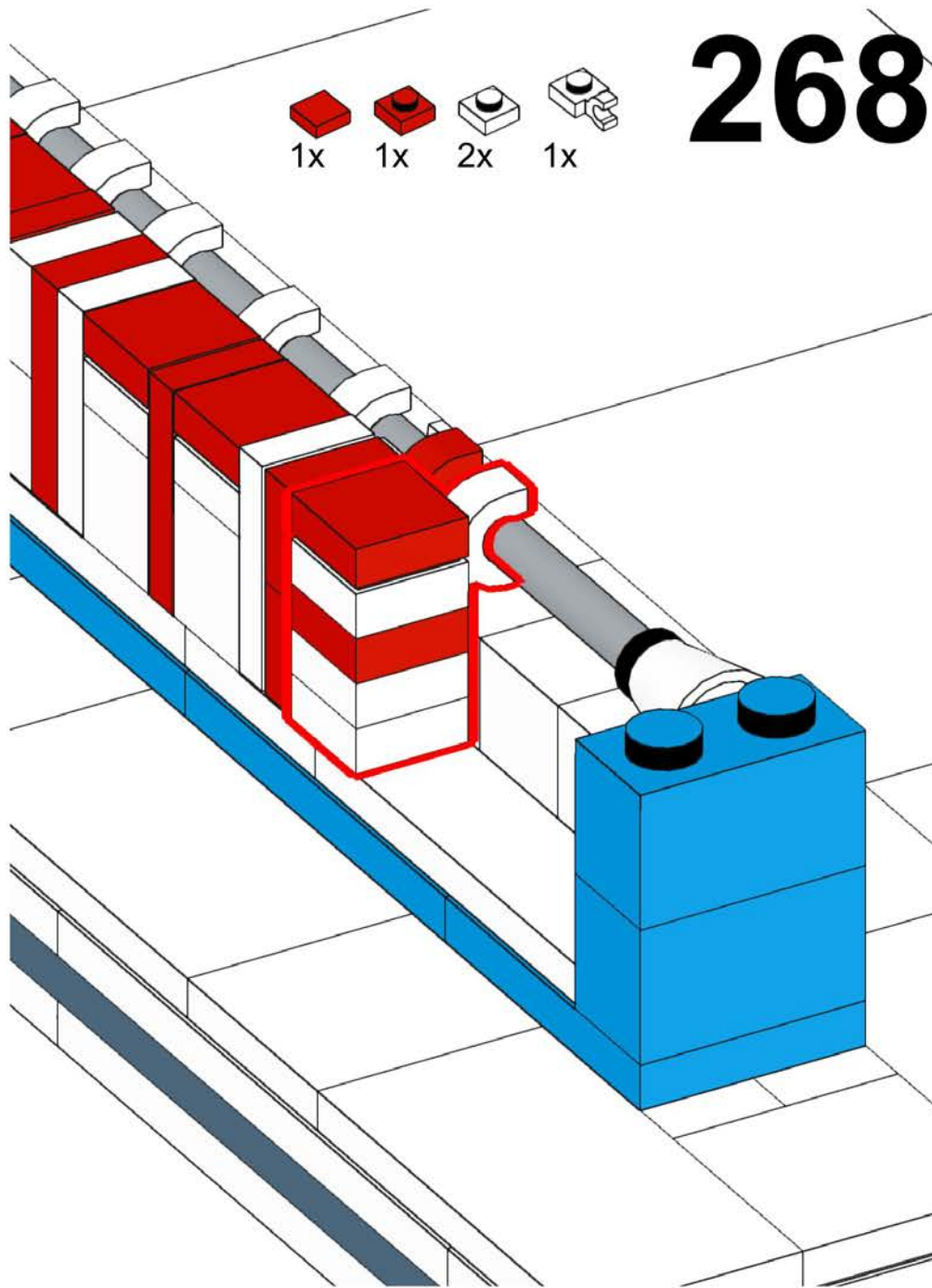



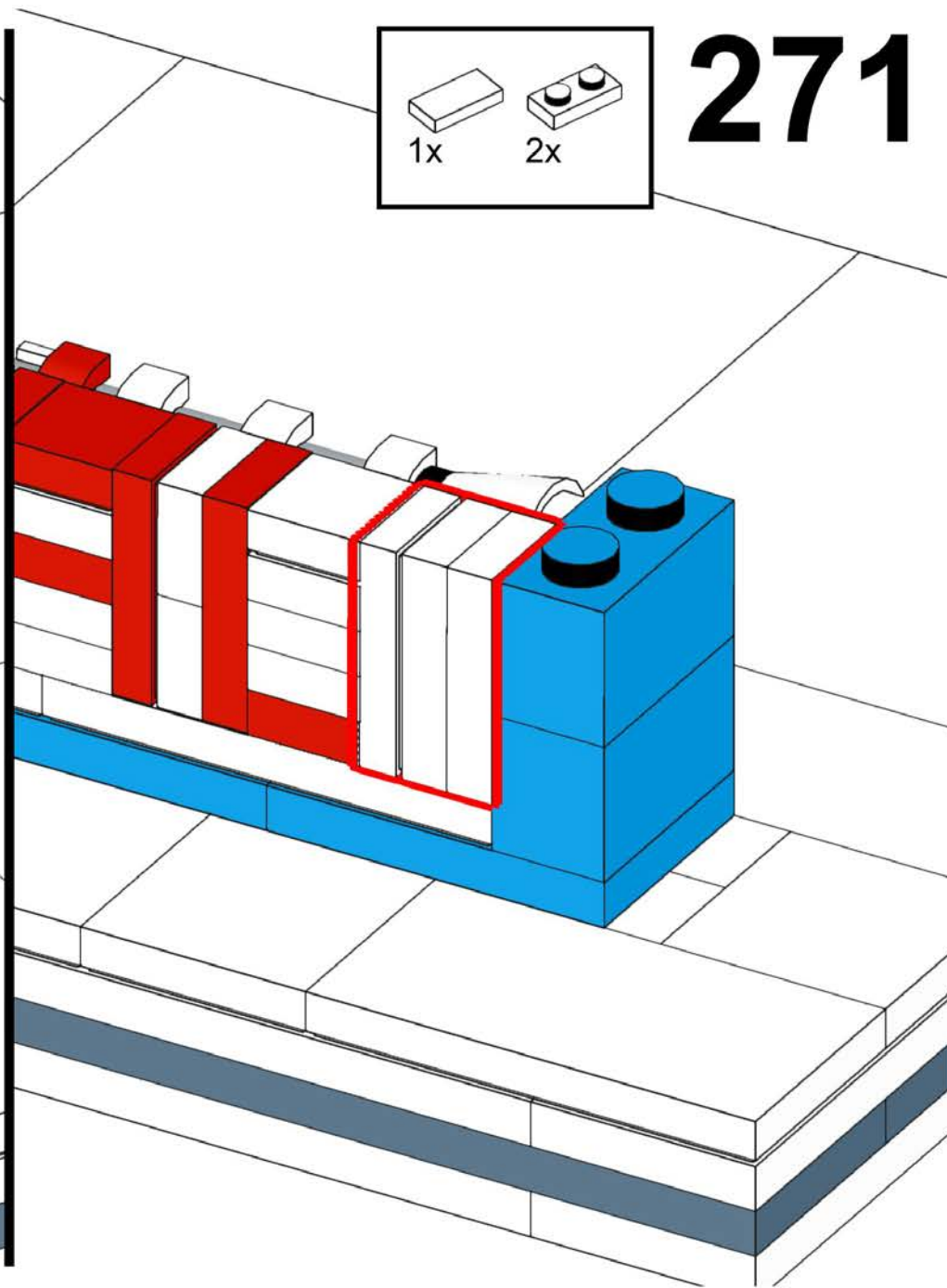
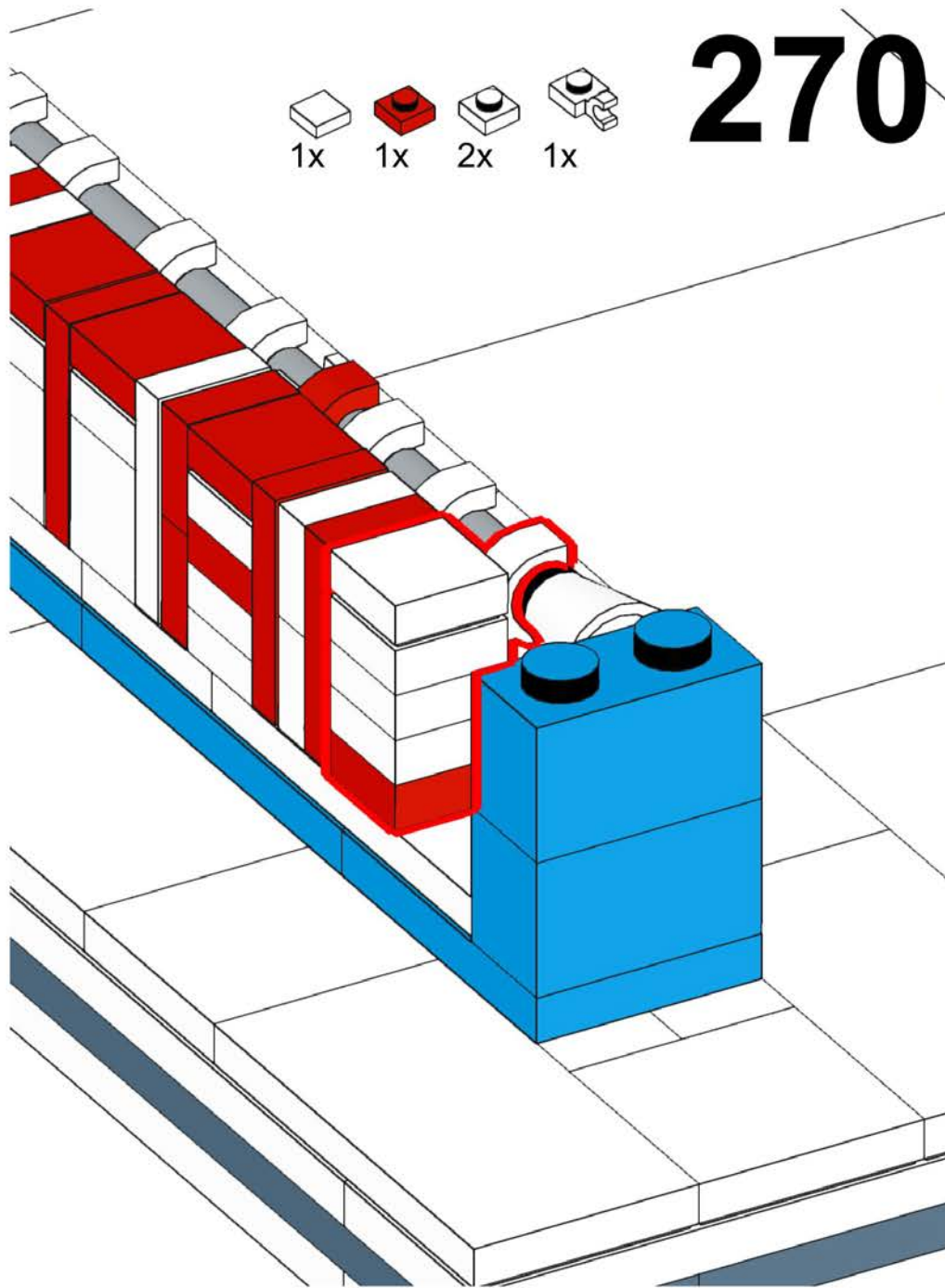

# 272

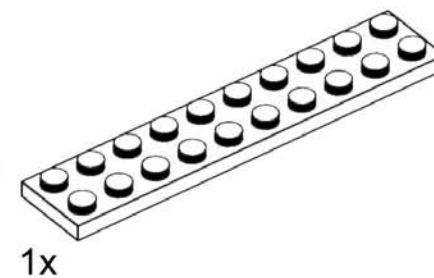
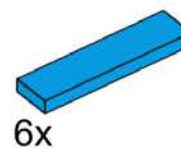
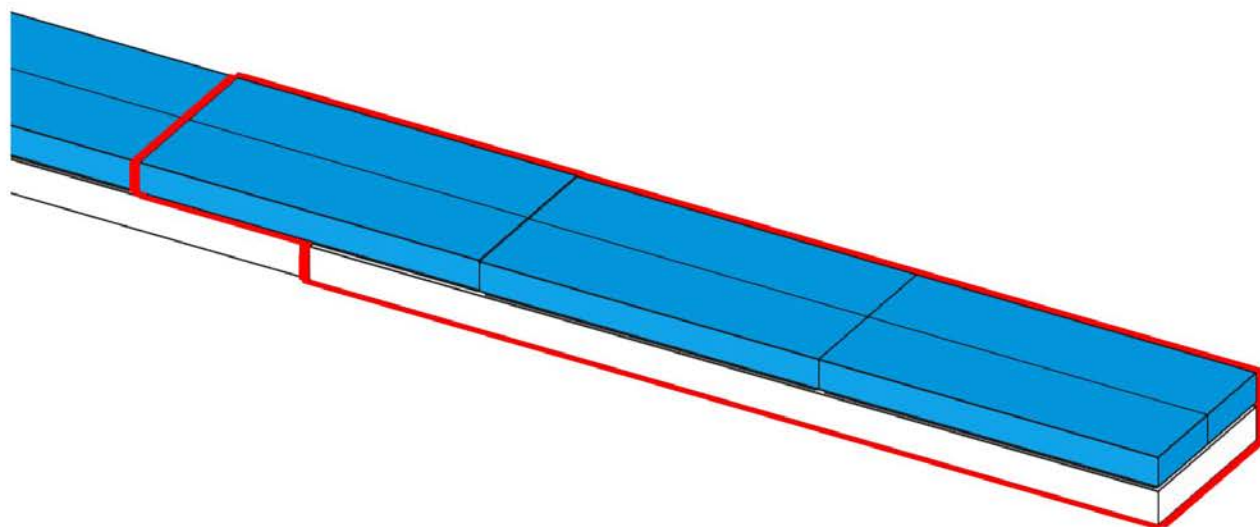
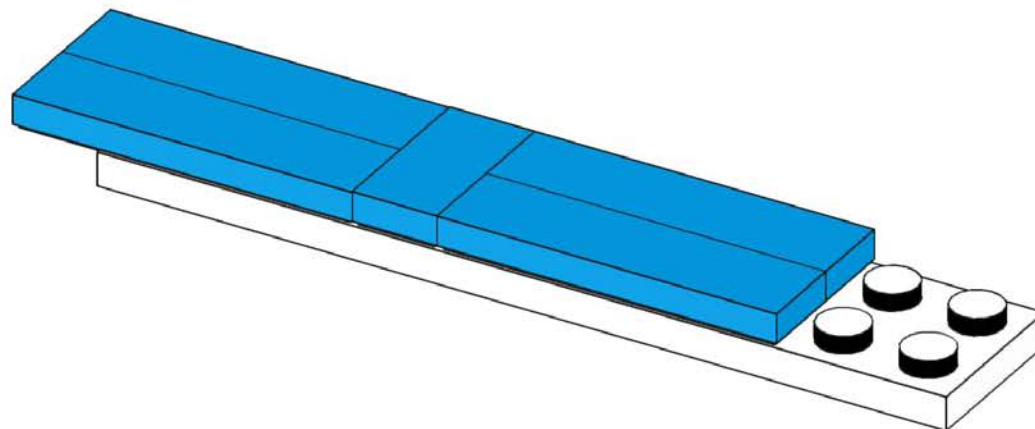
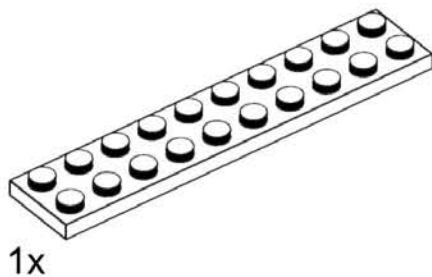
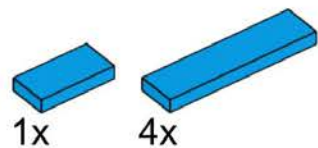
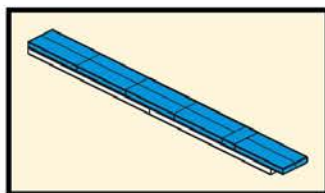

# 273

274

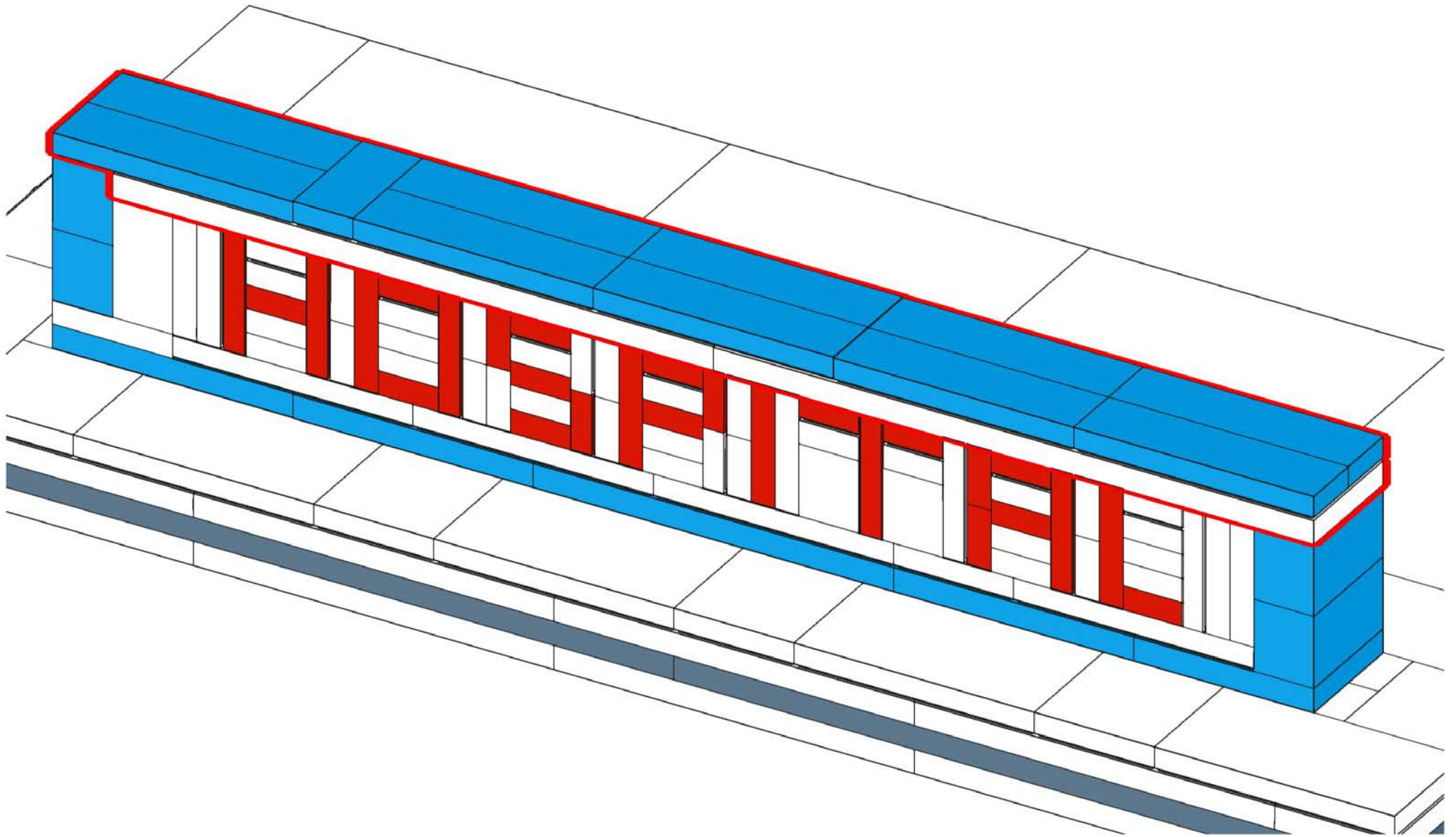

# 275

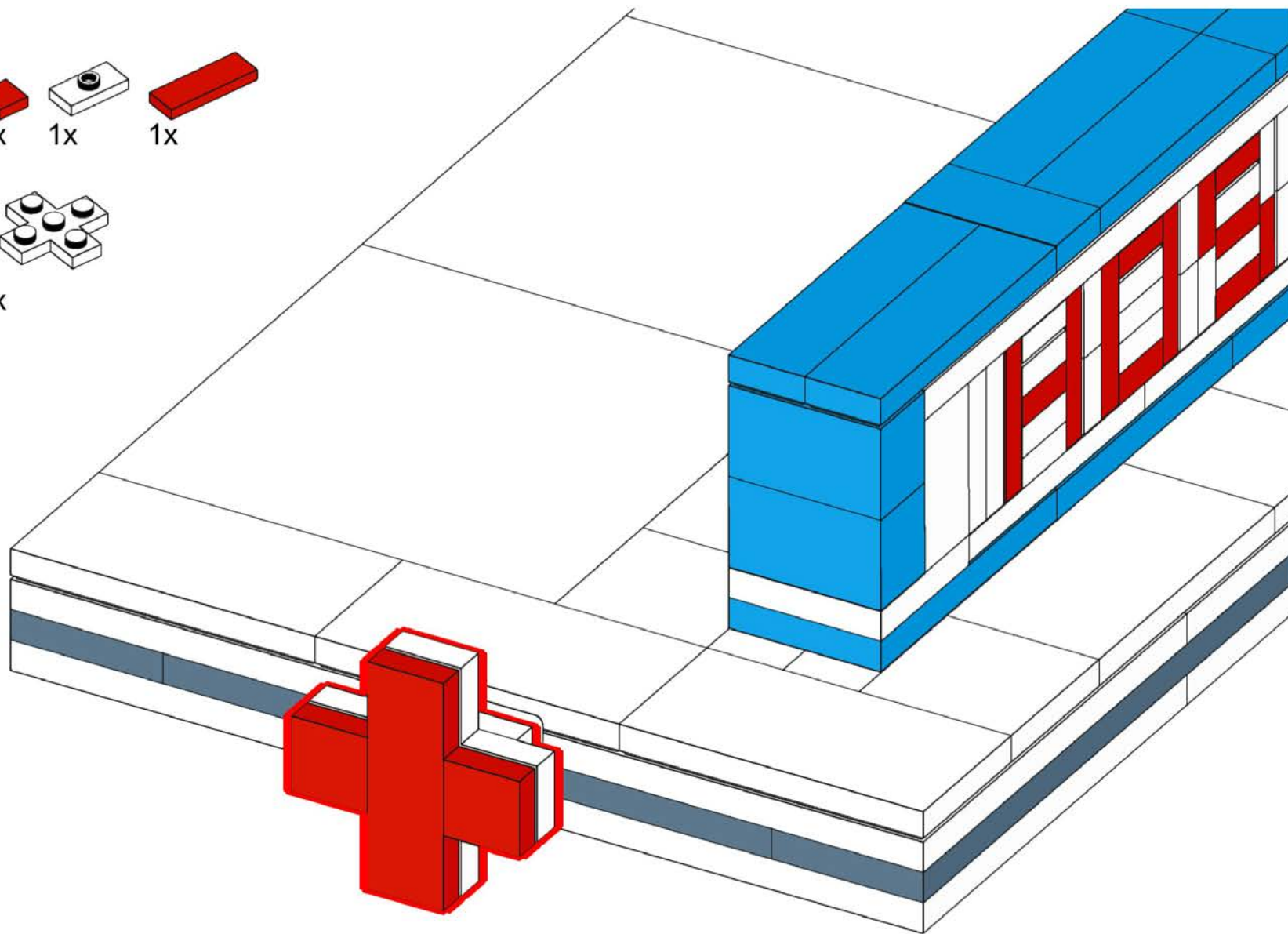
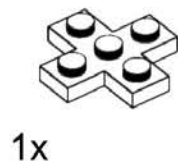
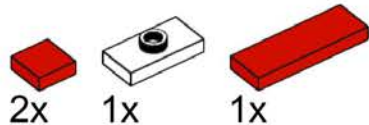

# 276

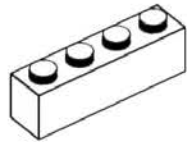

4x

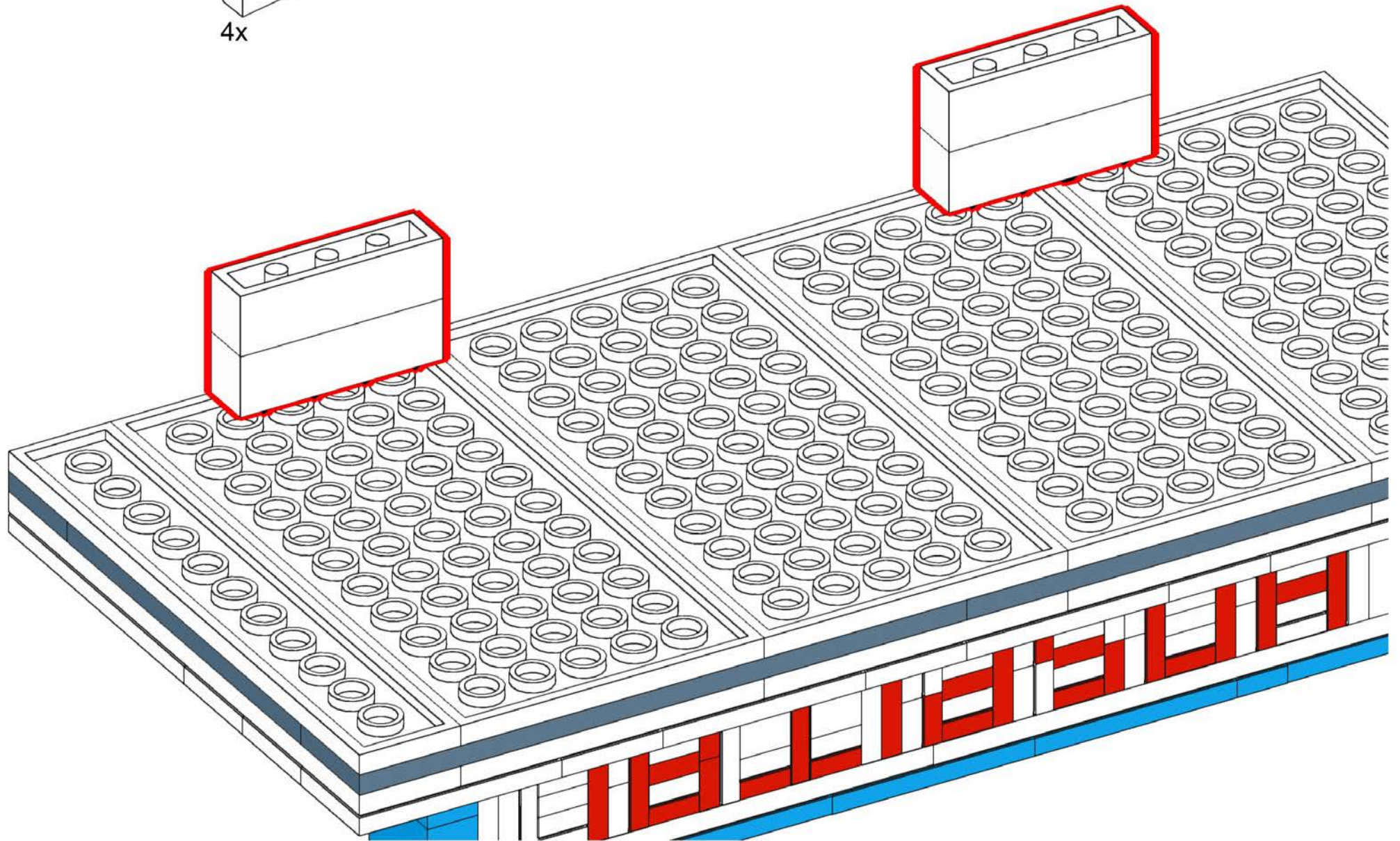

# 277

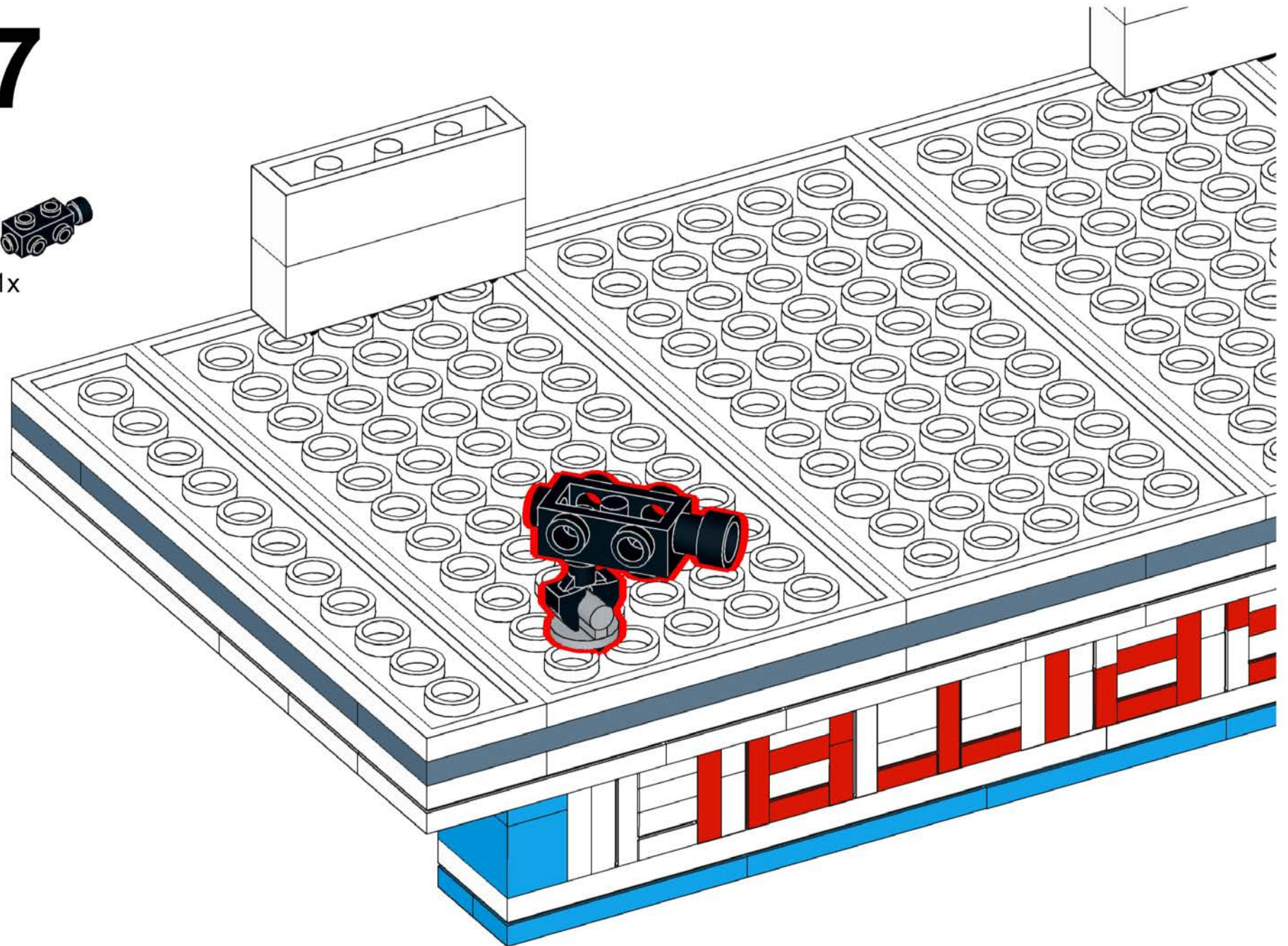

# 278

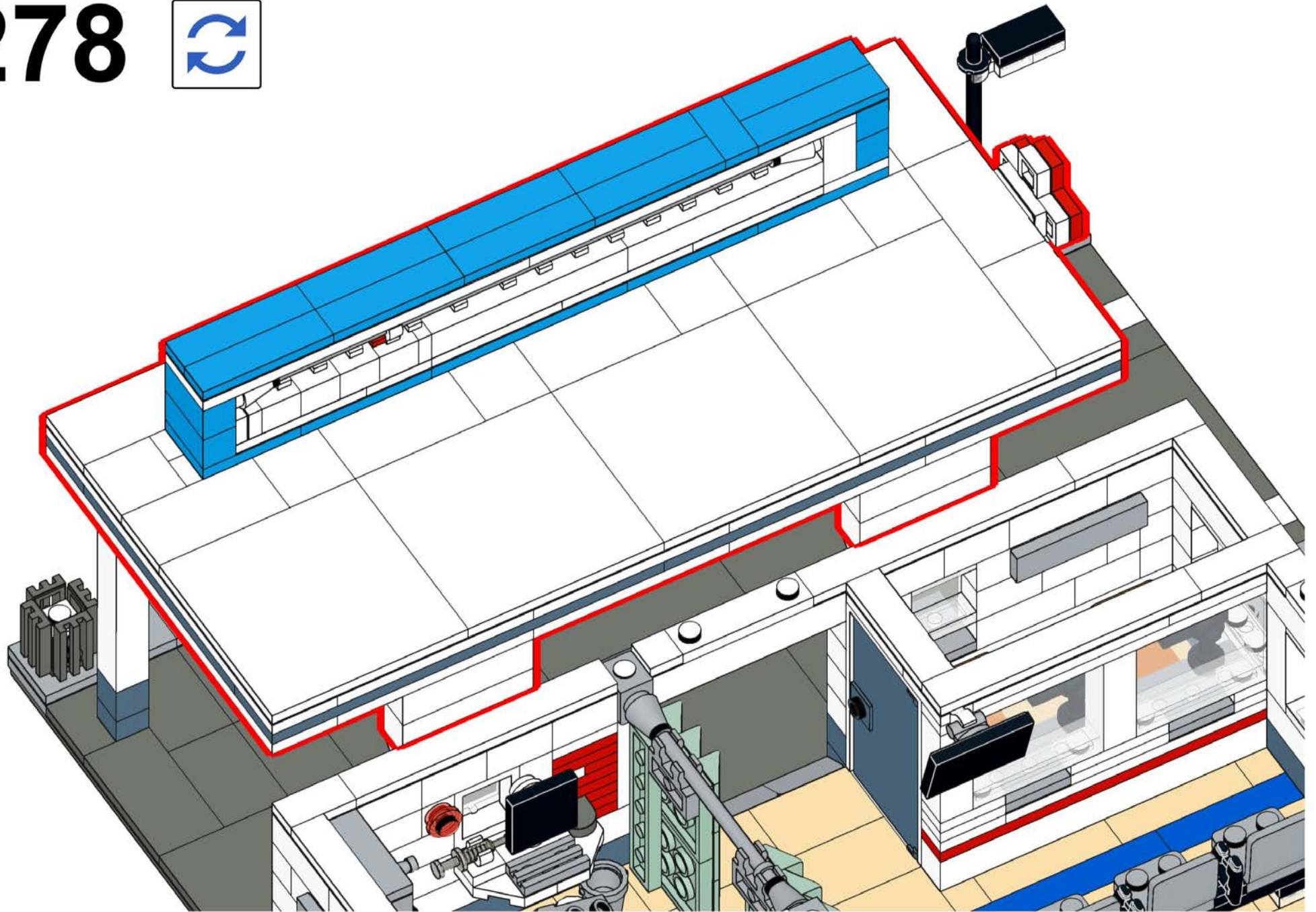

# 279

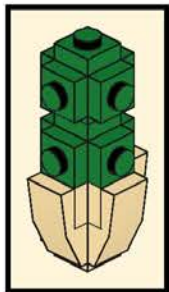
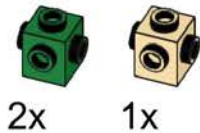
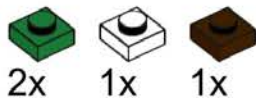

4x

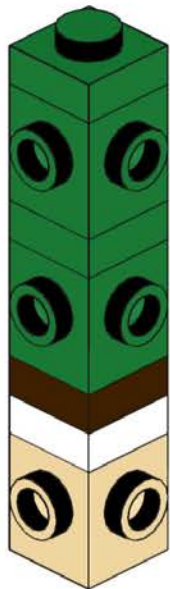

# 280

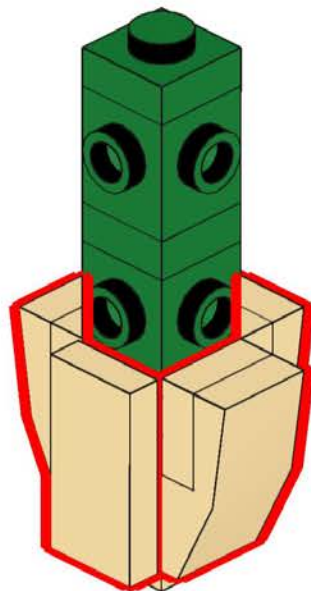
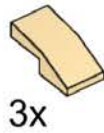
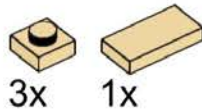

# 281

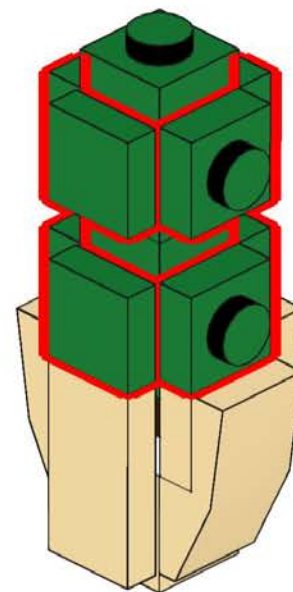
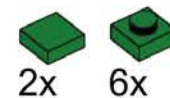



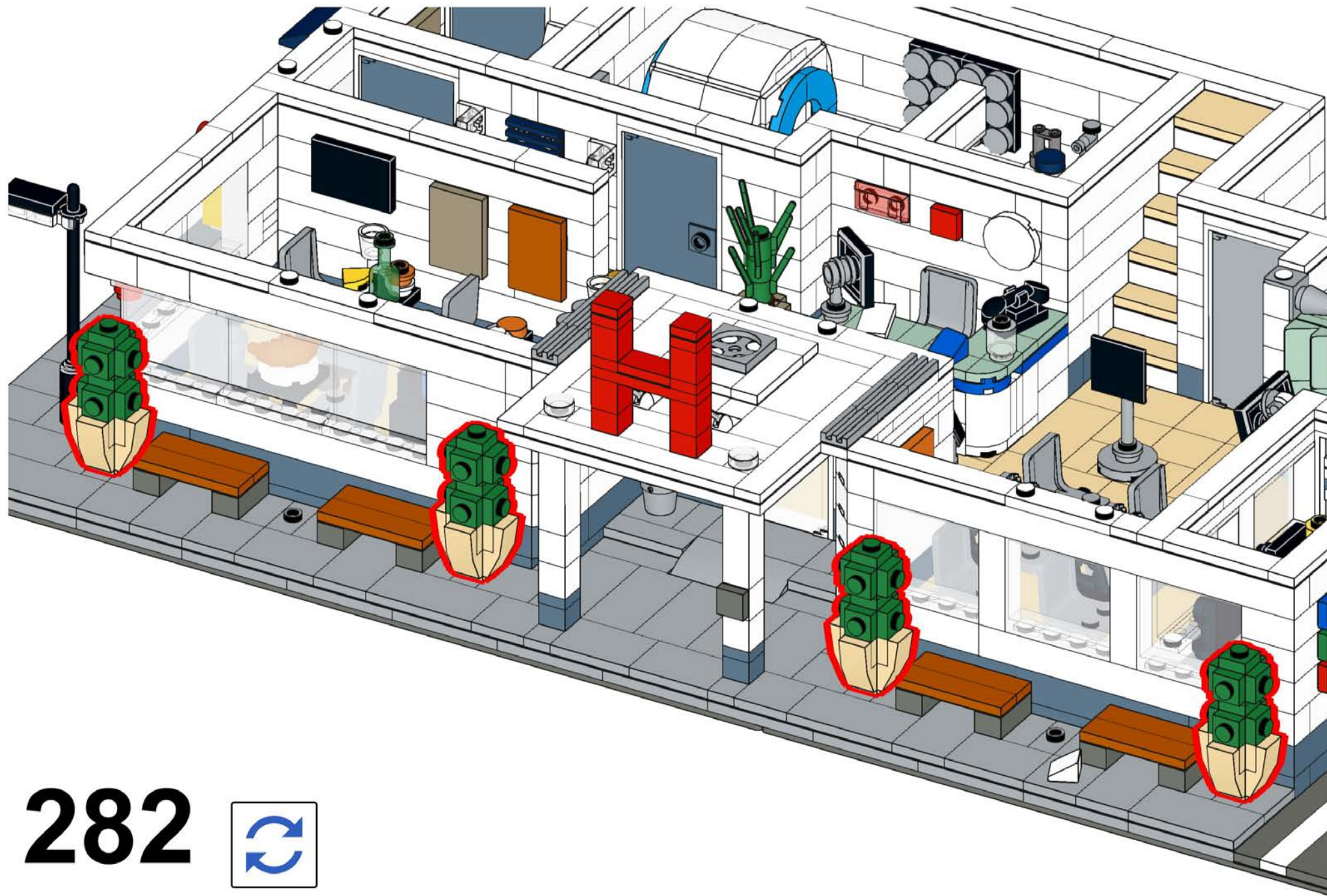

282



# 283

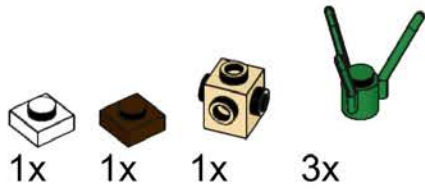

2x



# 284

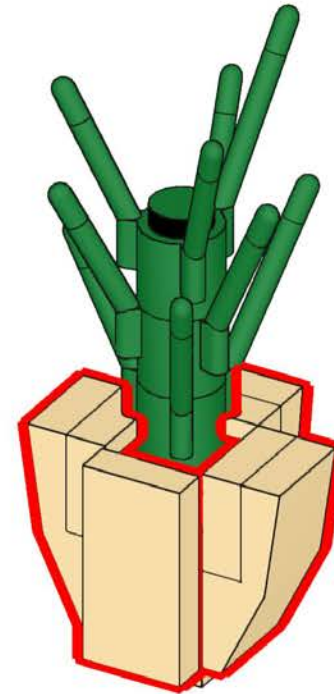
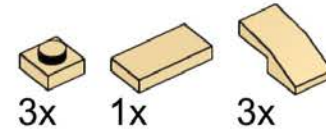

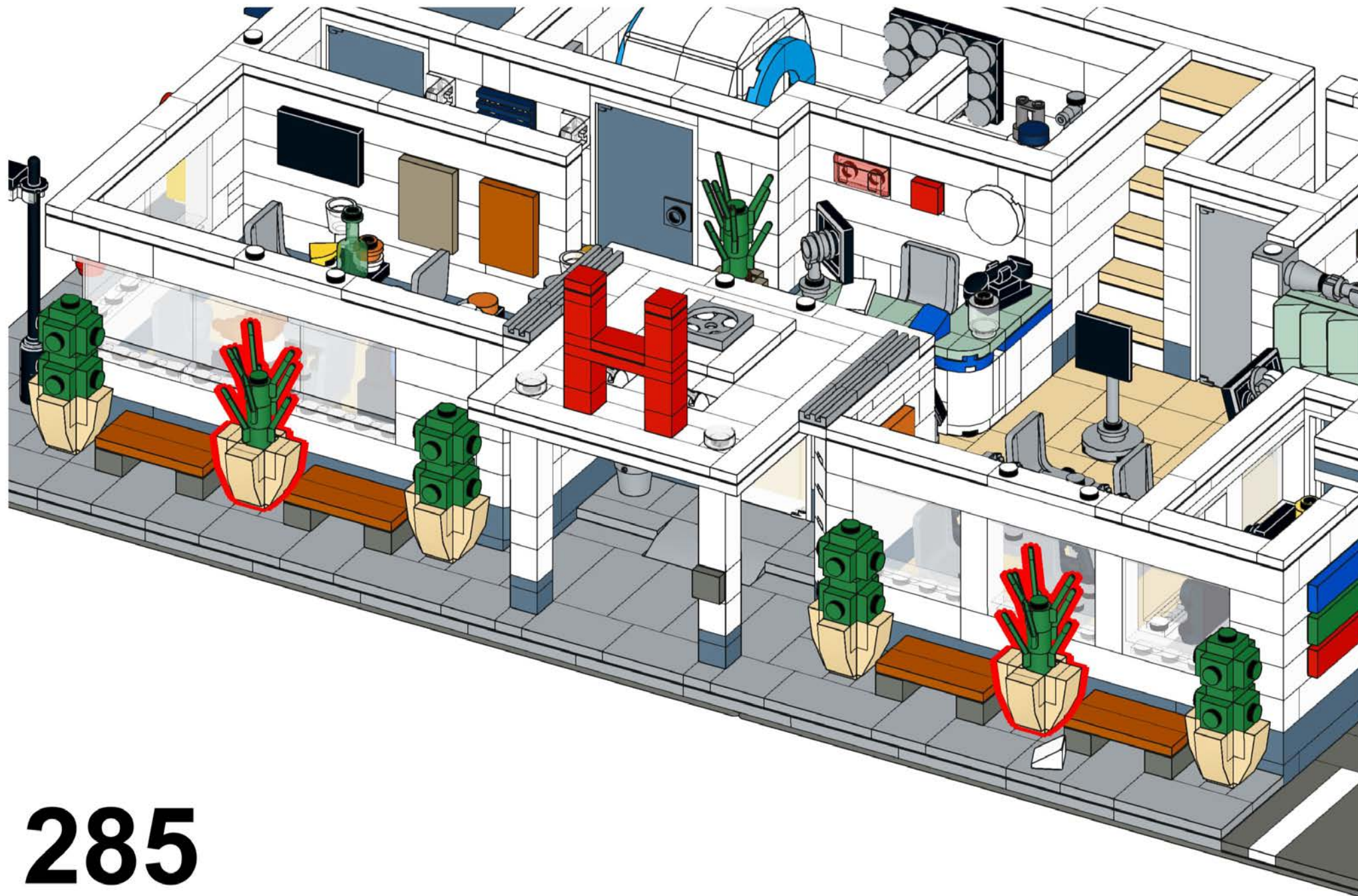

285

# 286

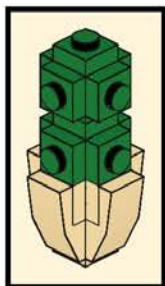
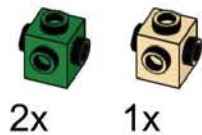
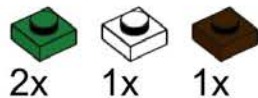

2x

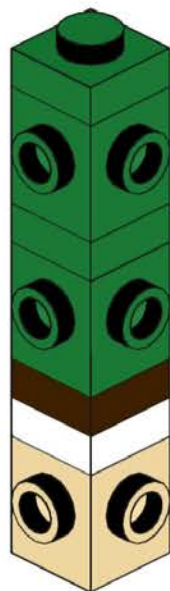

# 287

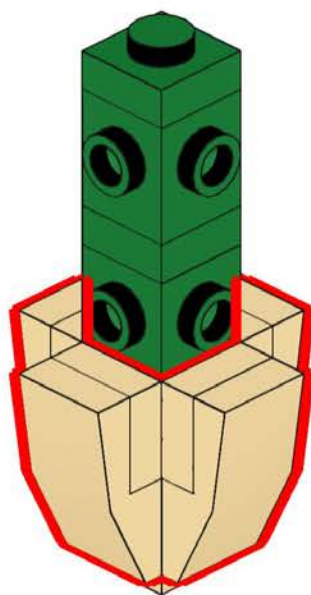
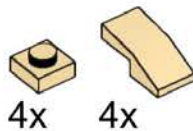

# 288

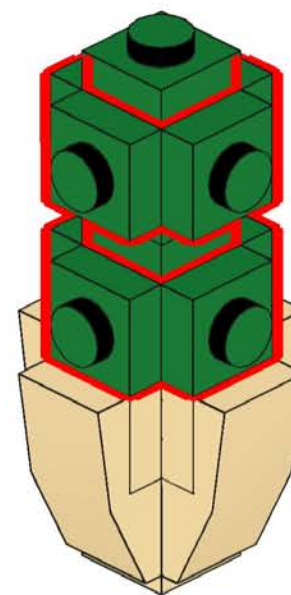

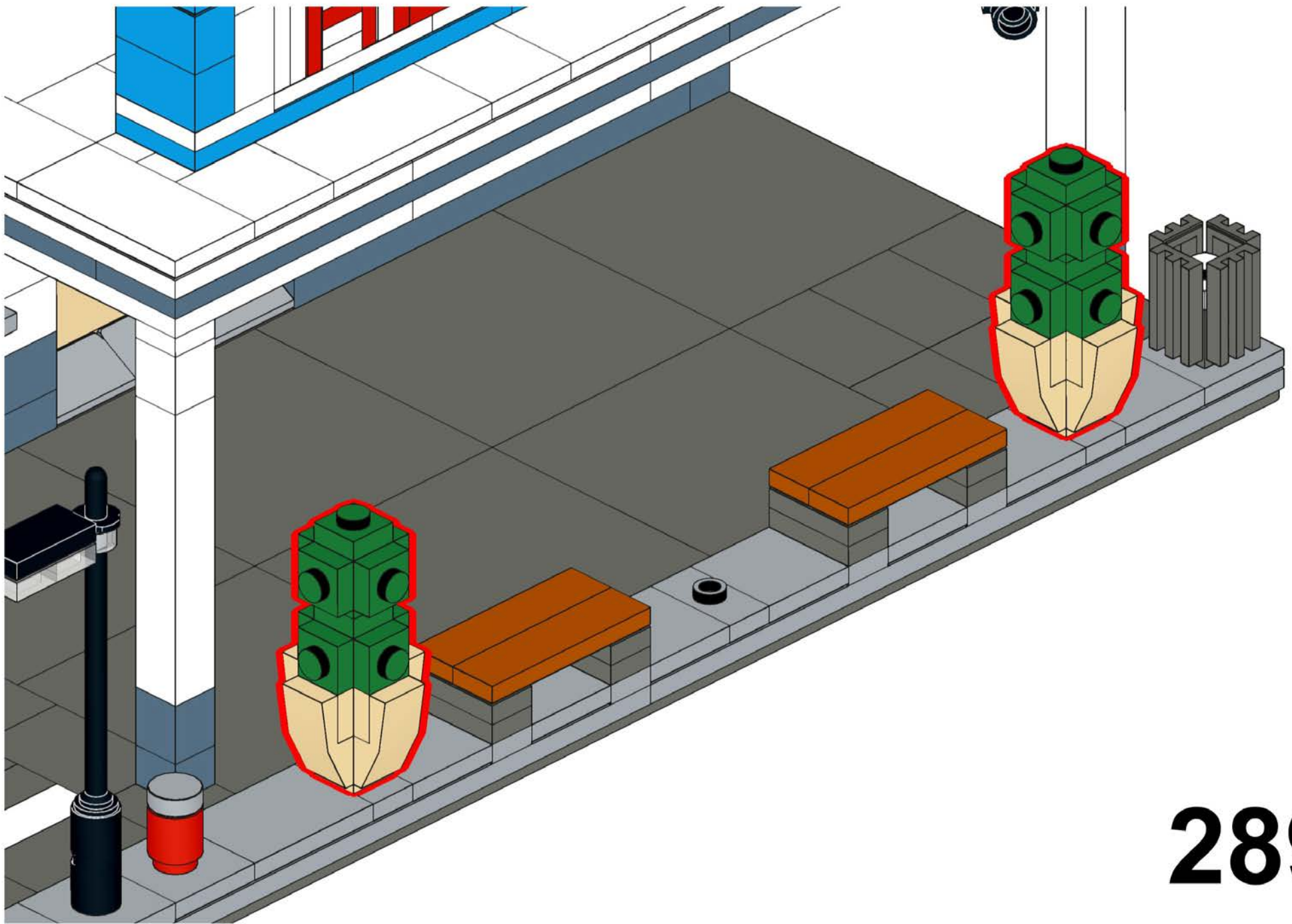

289

# 290

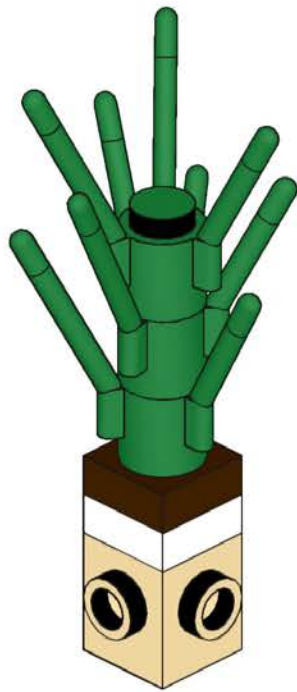
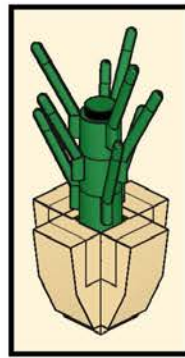
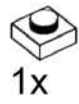

# 291

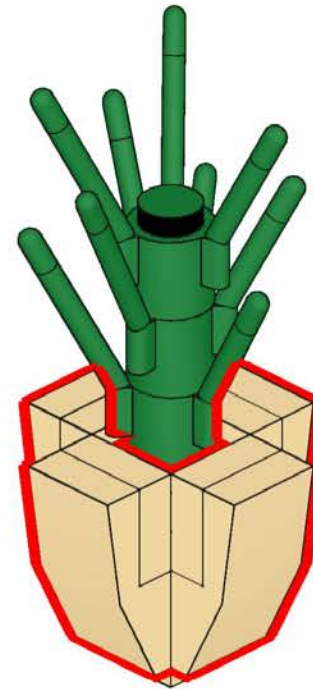
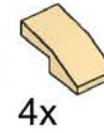

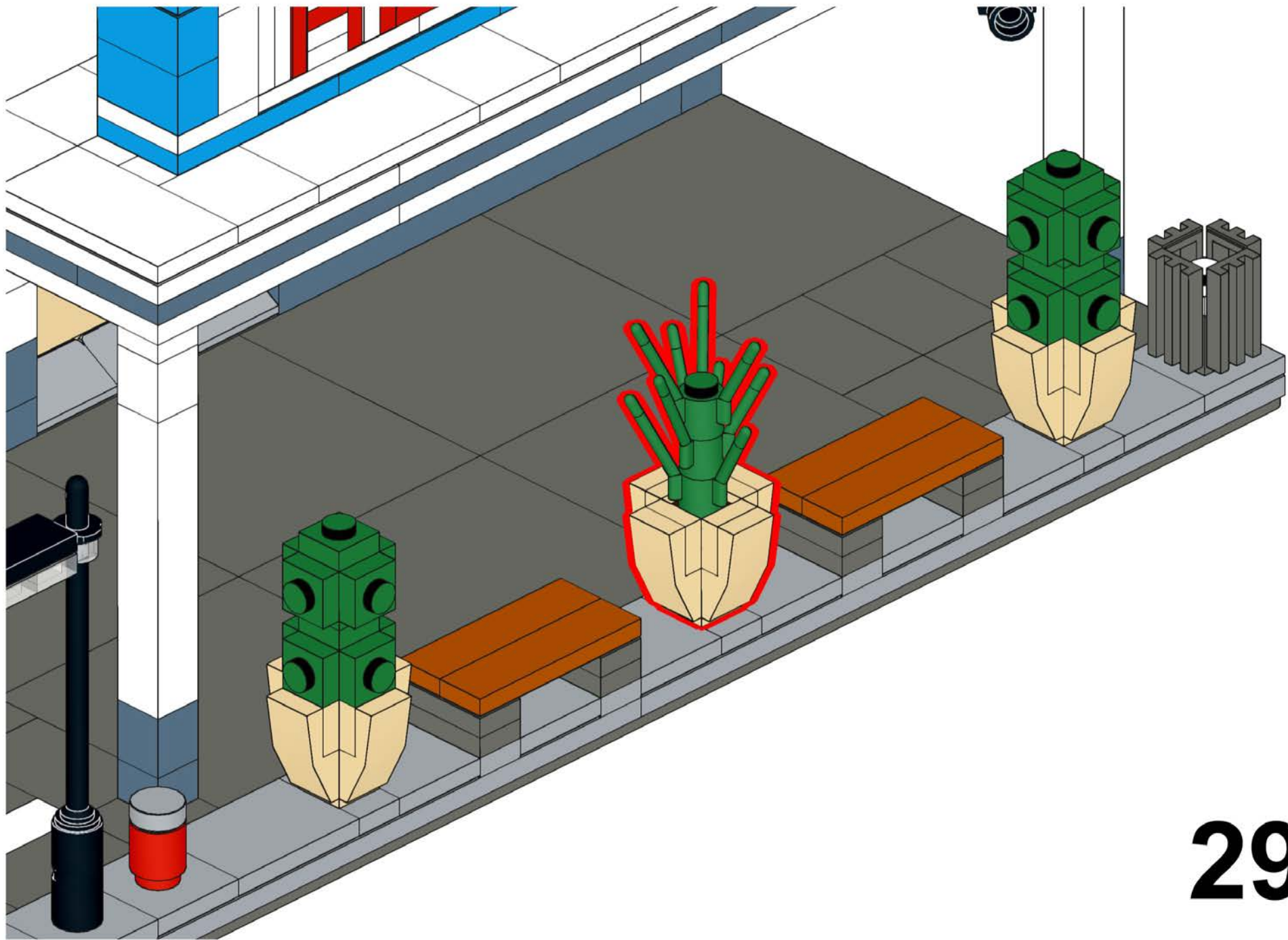

292

# 293

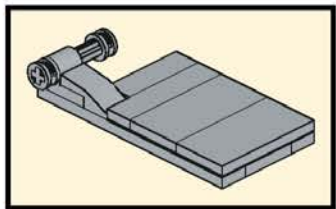
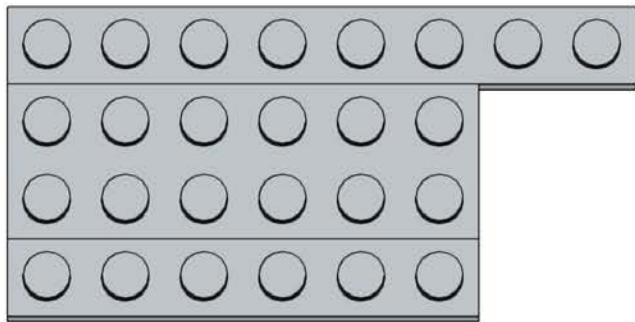
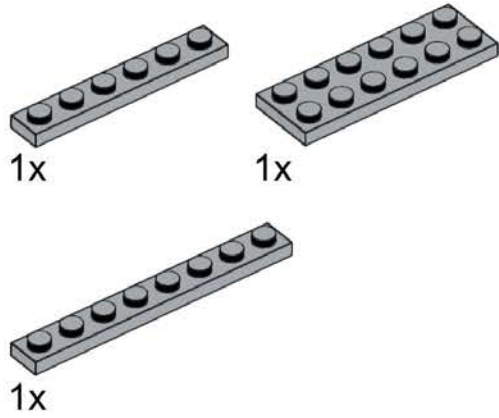

# 294

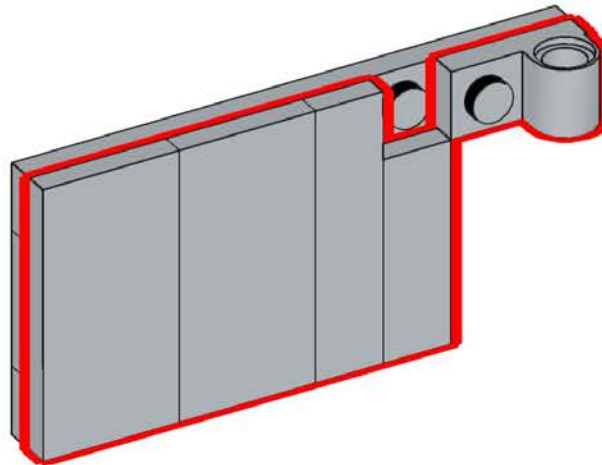
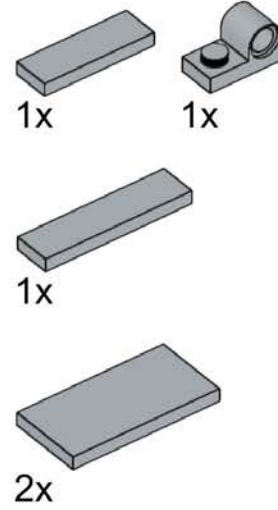

# 295

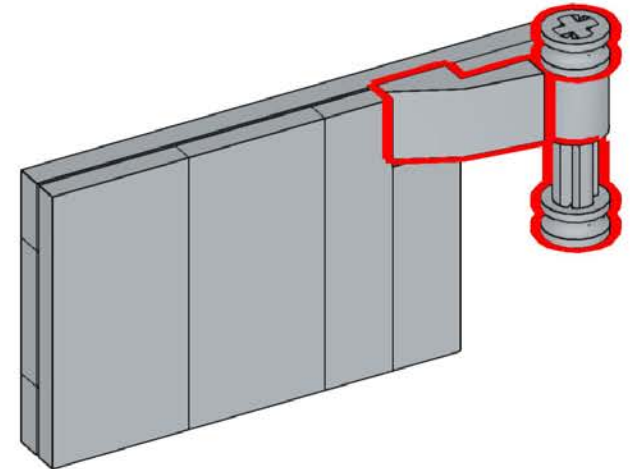
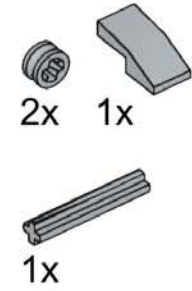



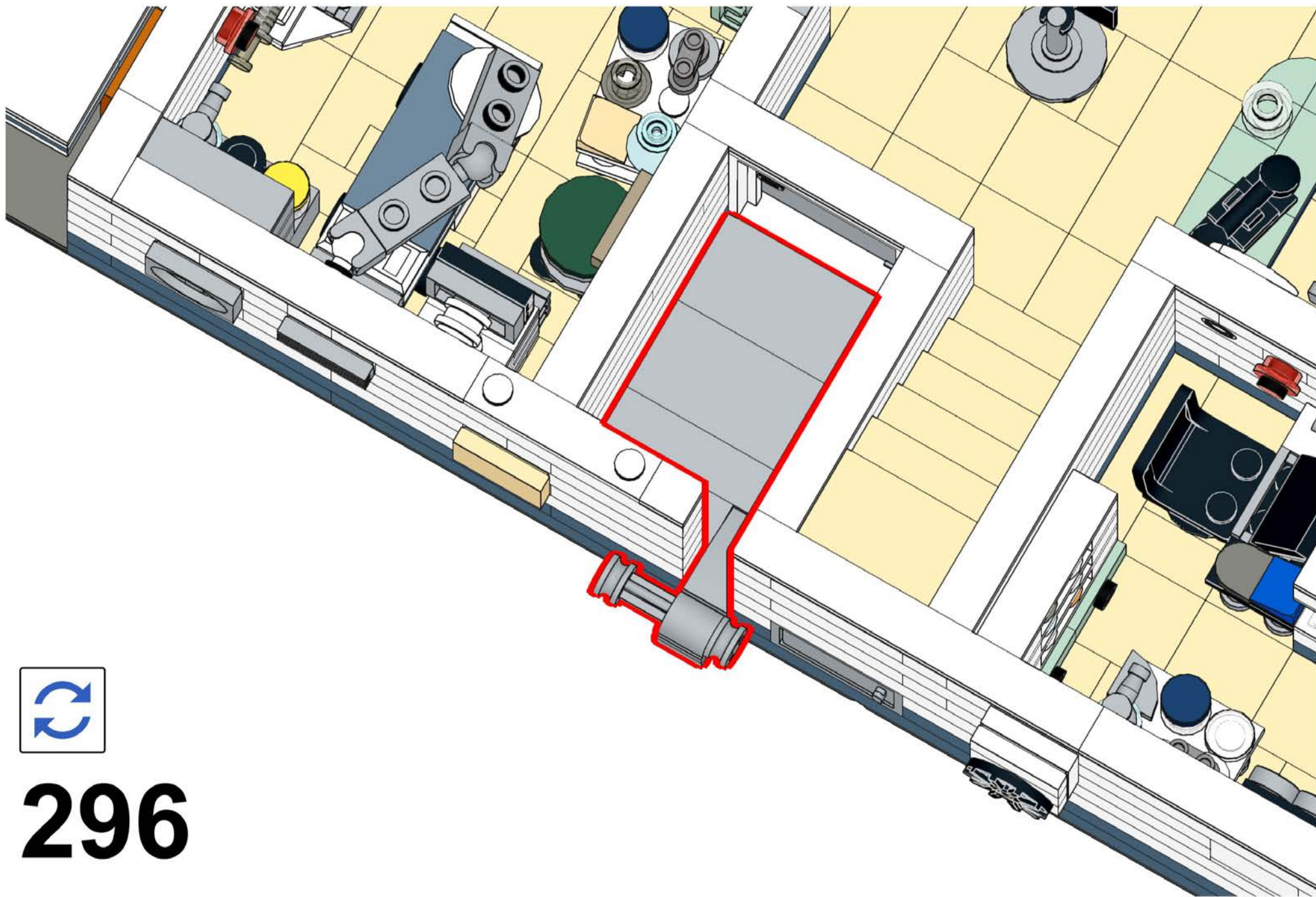

**296**

# 297

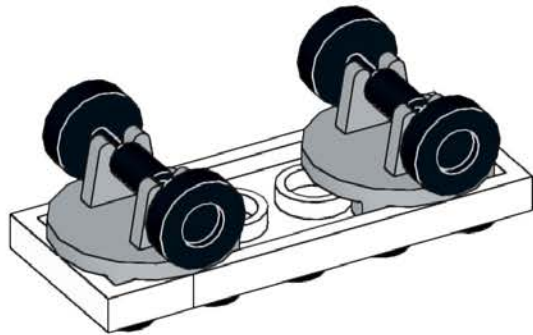

# 299

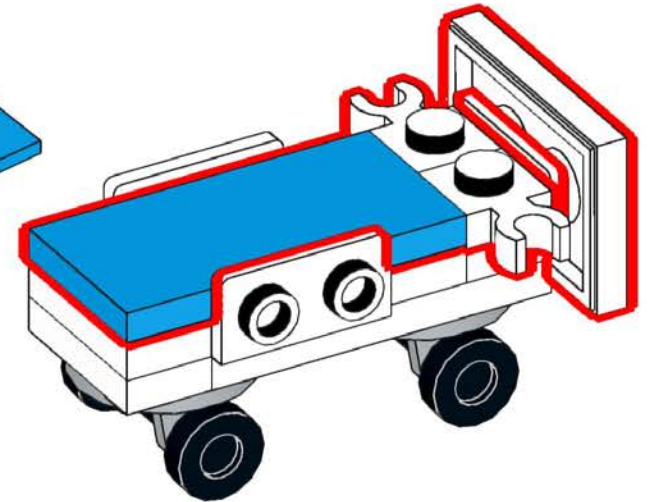
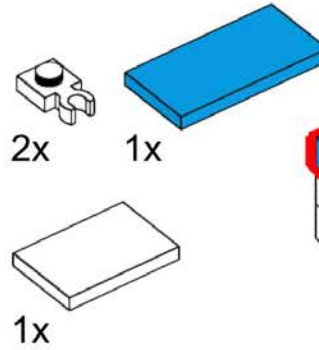

# 298

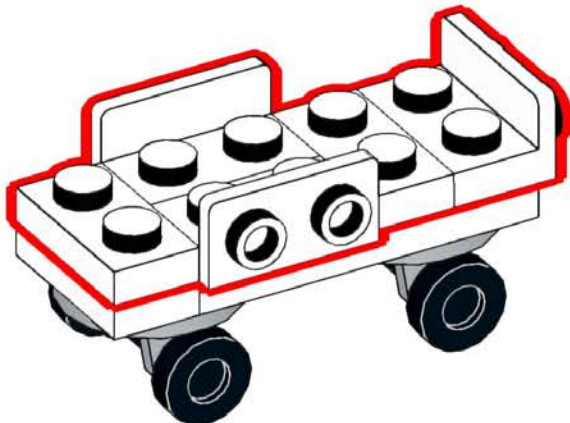
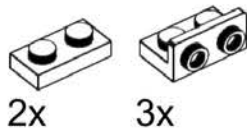

# 300

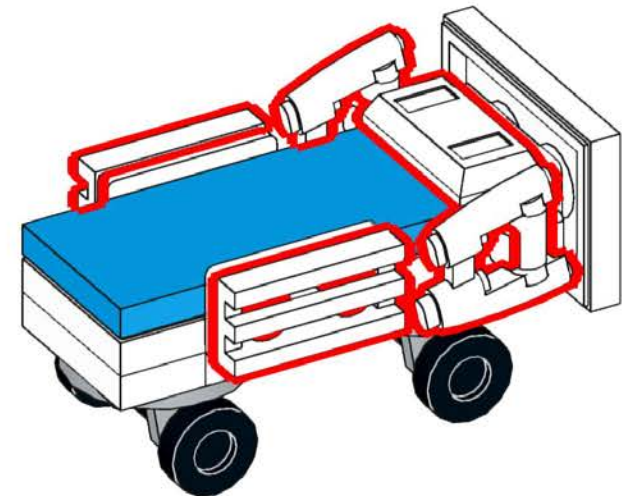
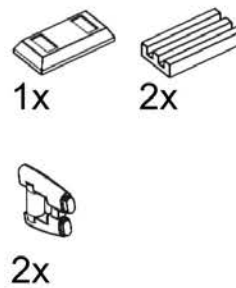

# 301

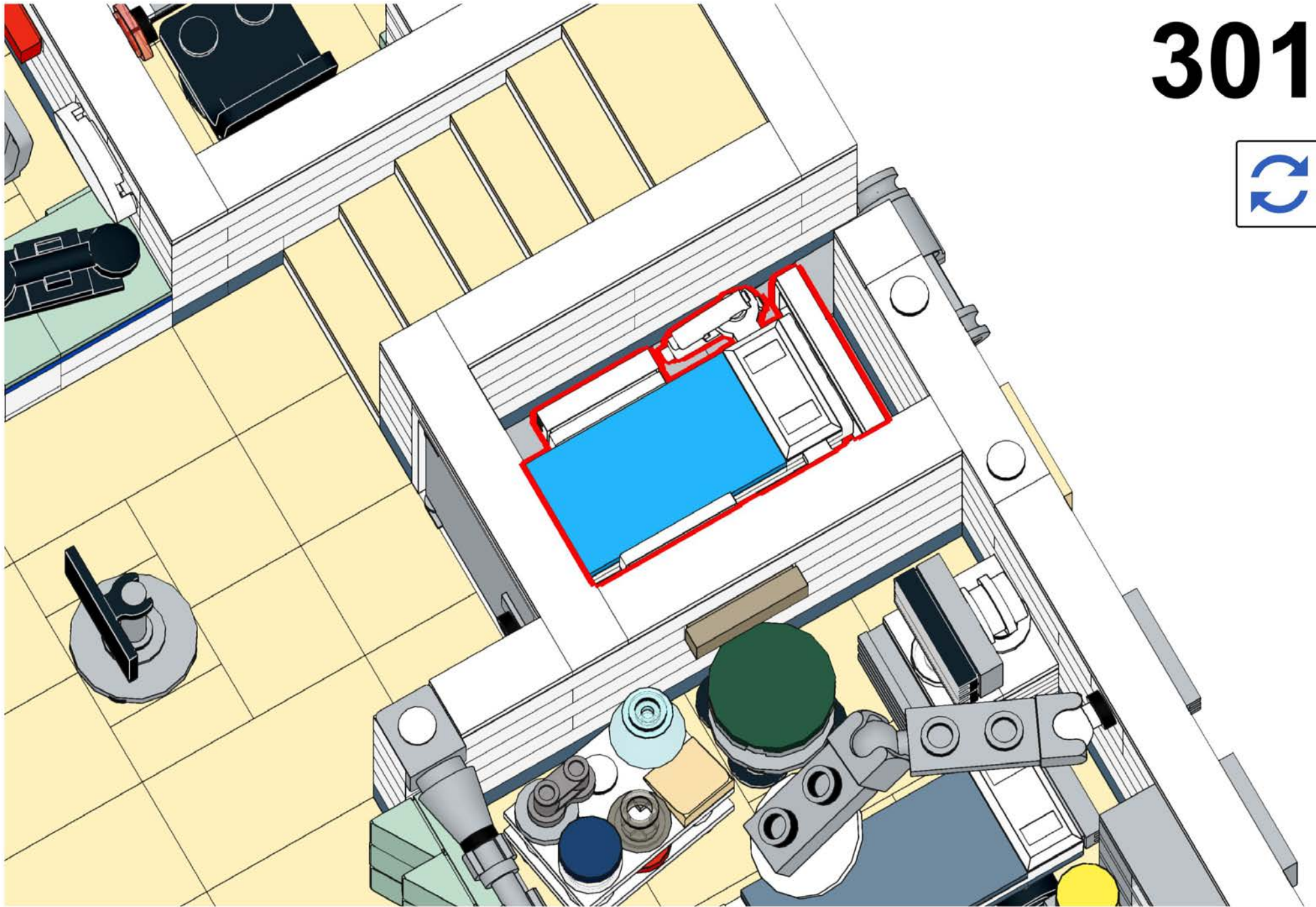

302

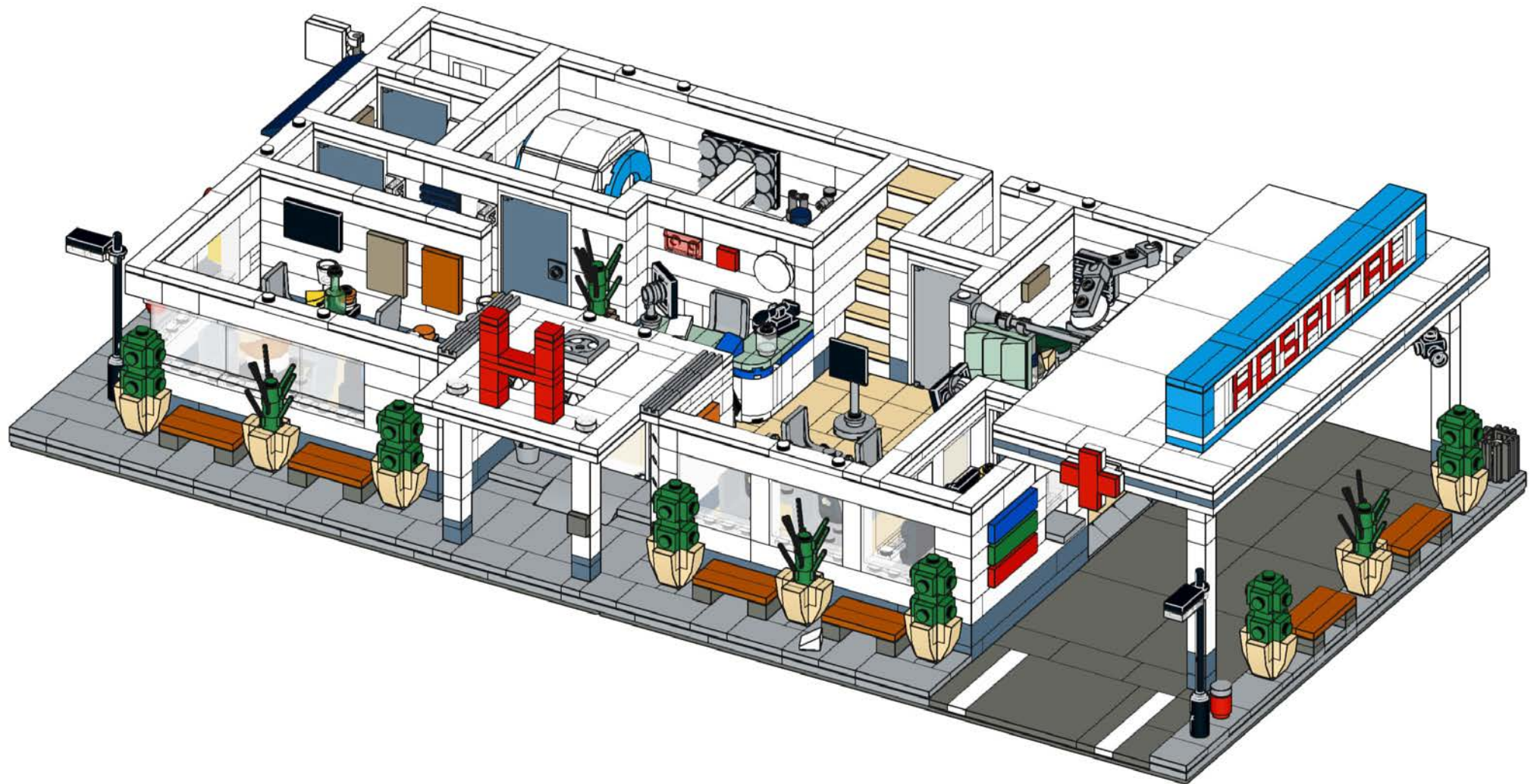

# 303

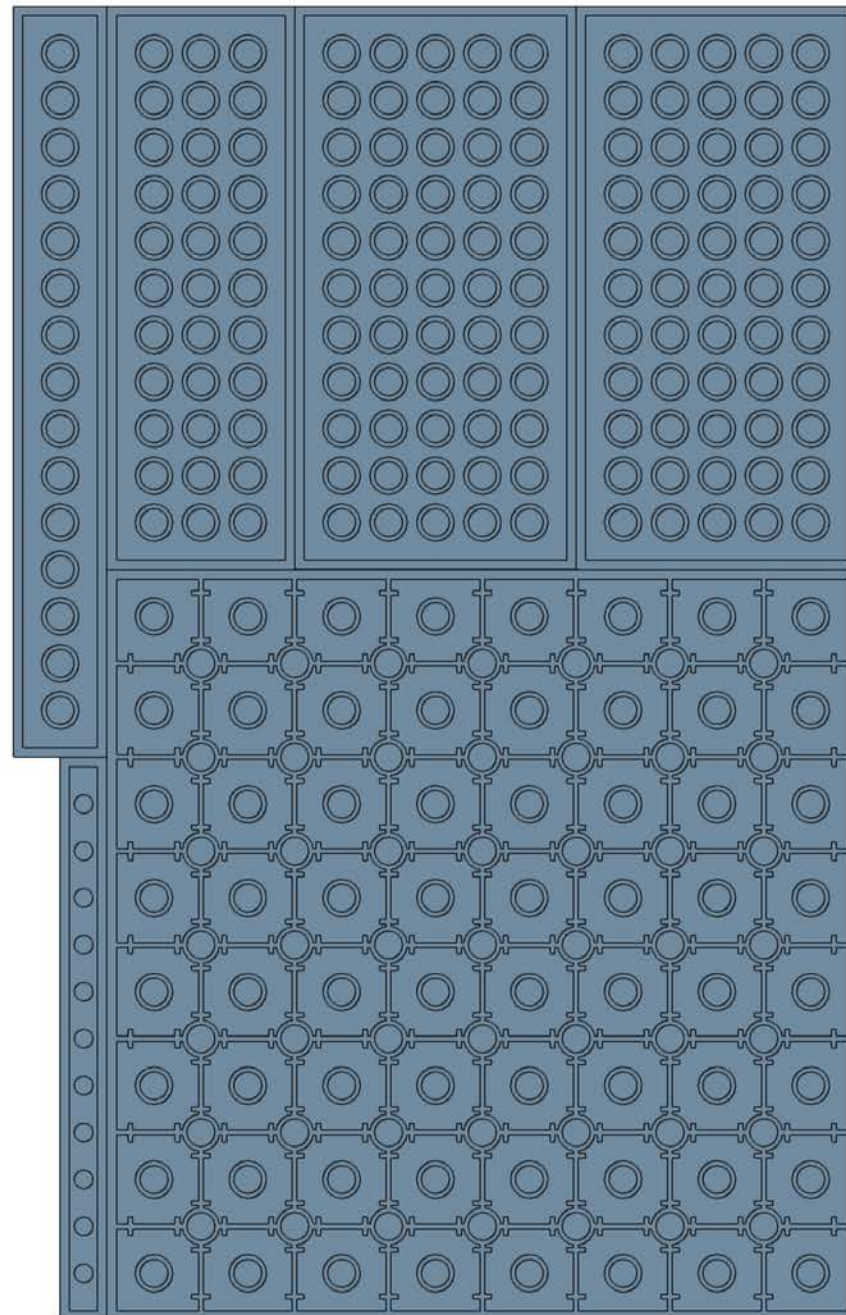
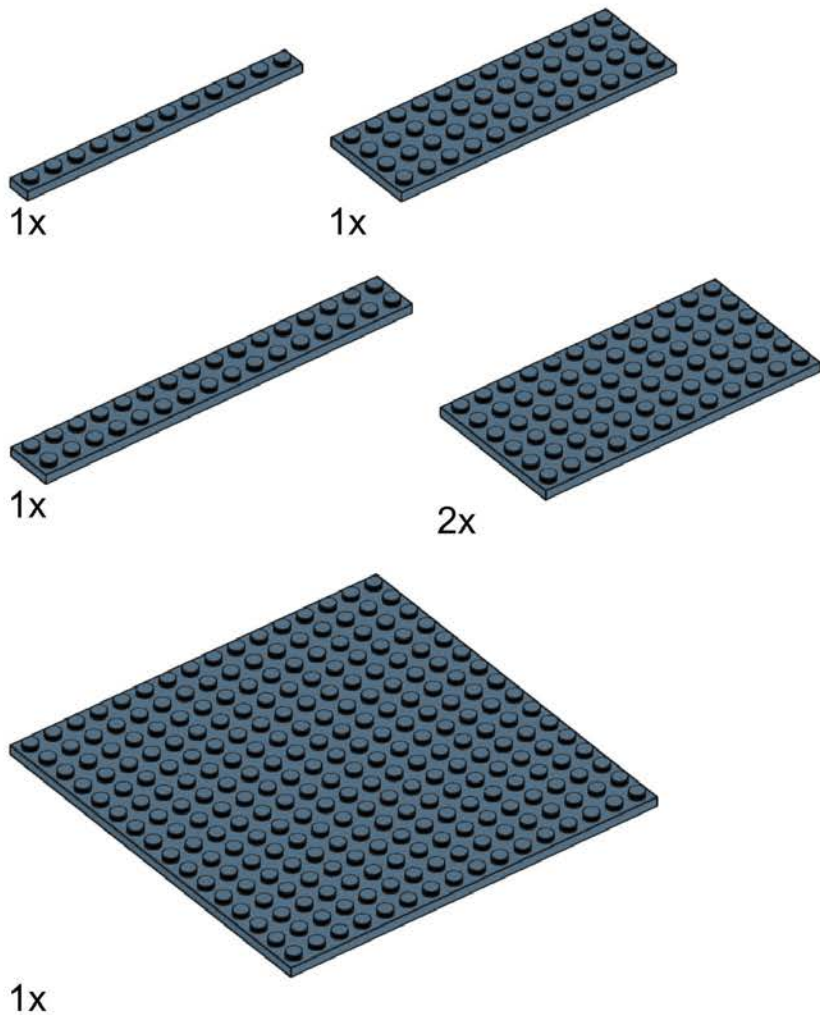

# 304

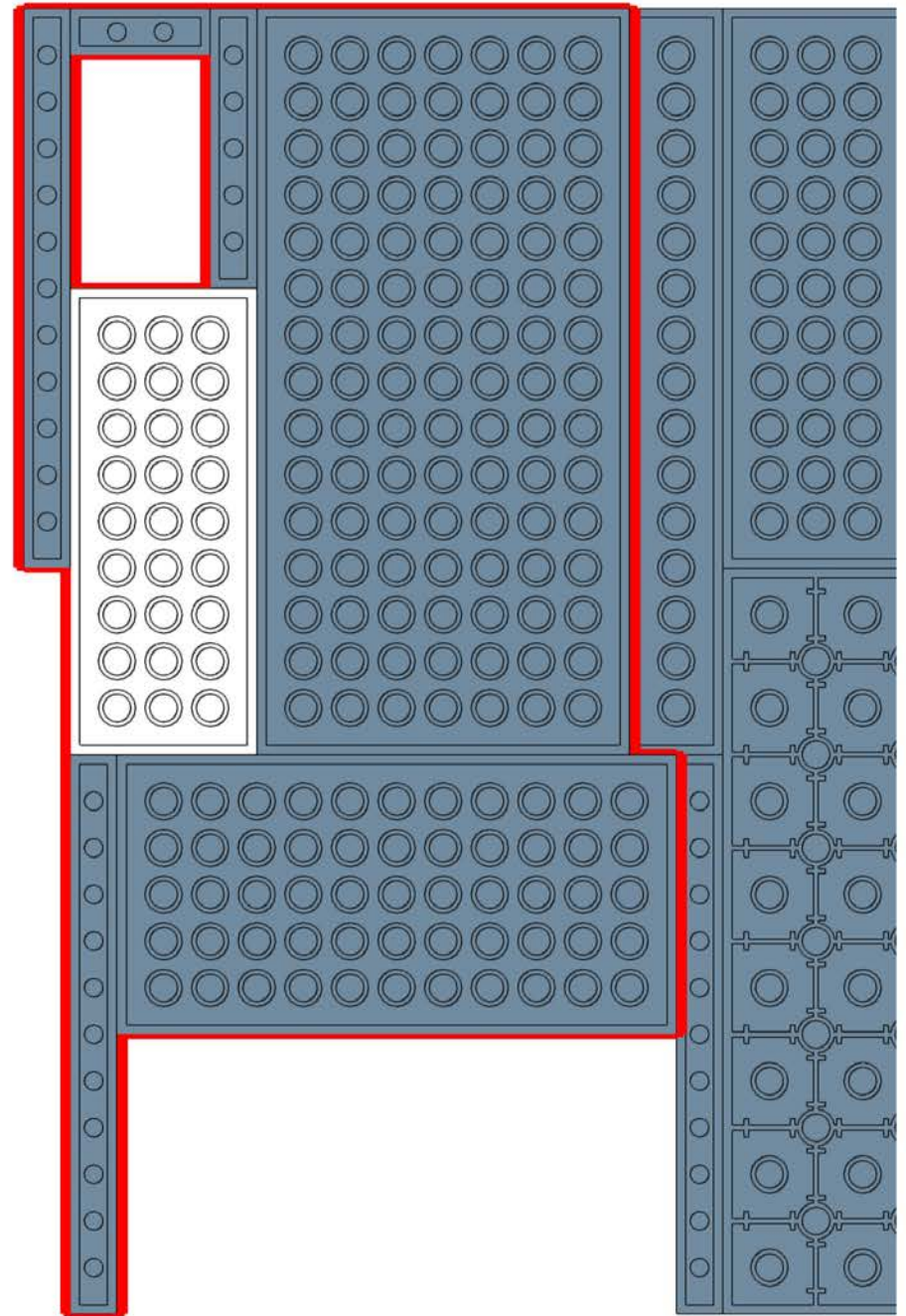
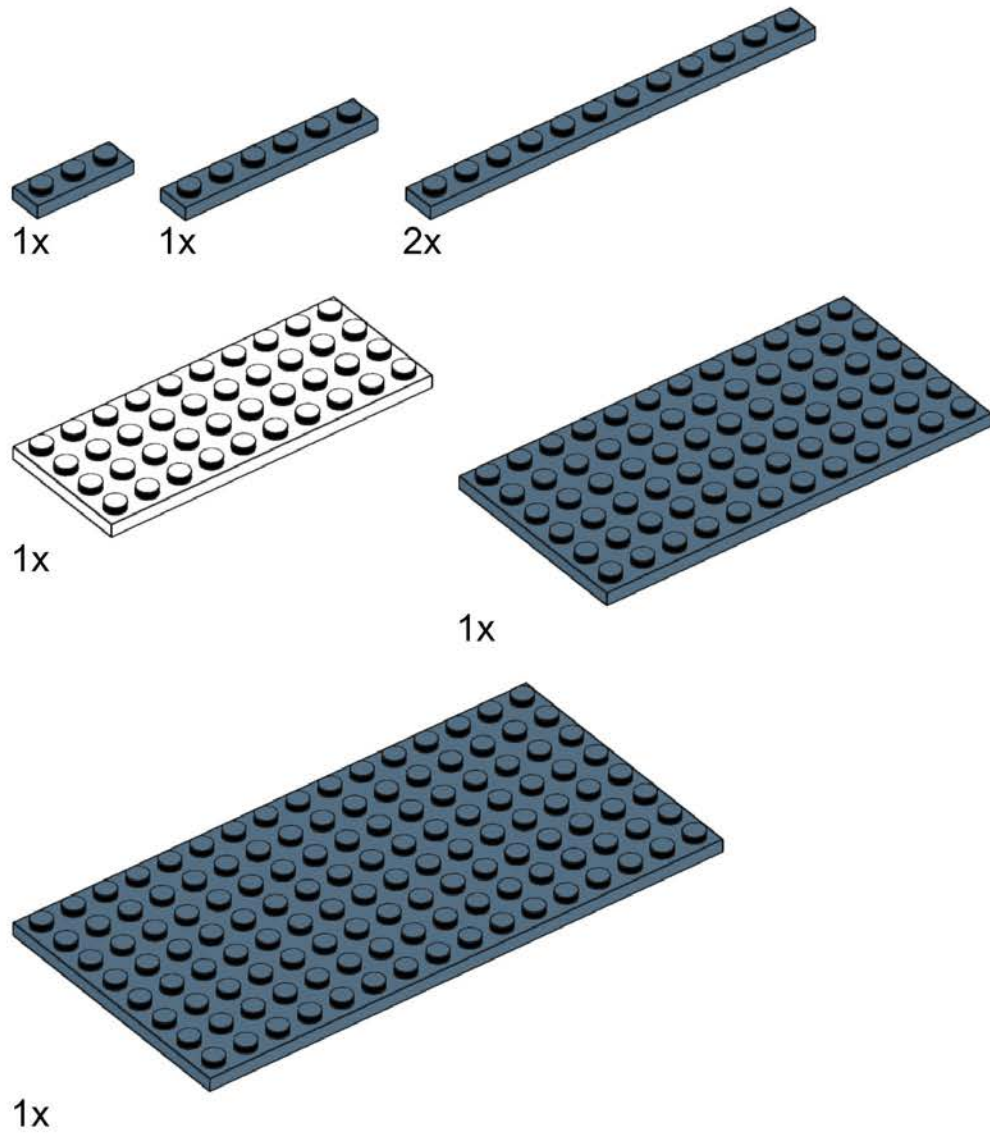

# 305

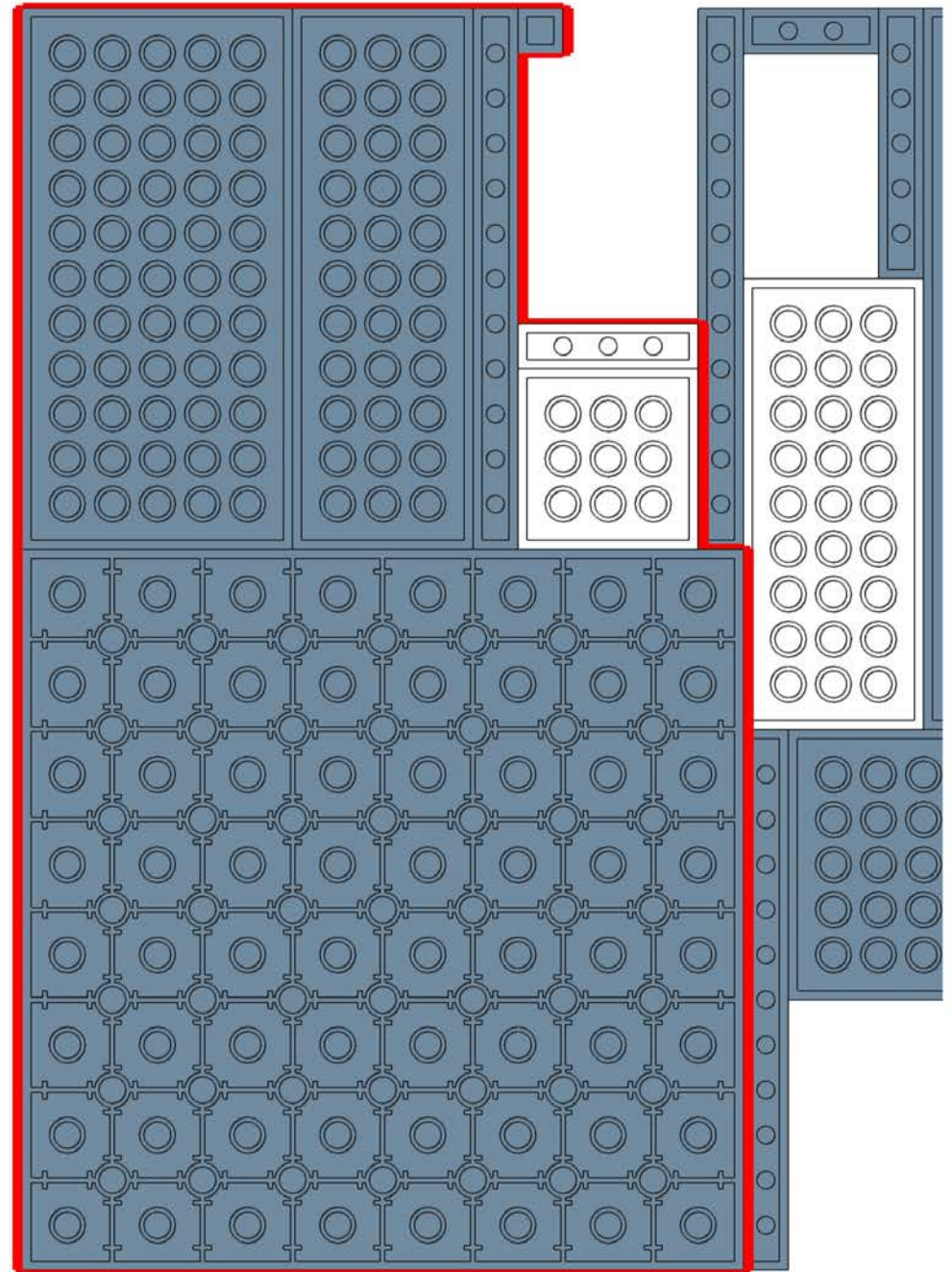
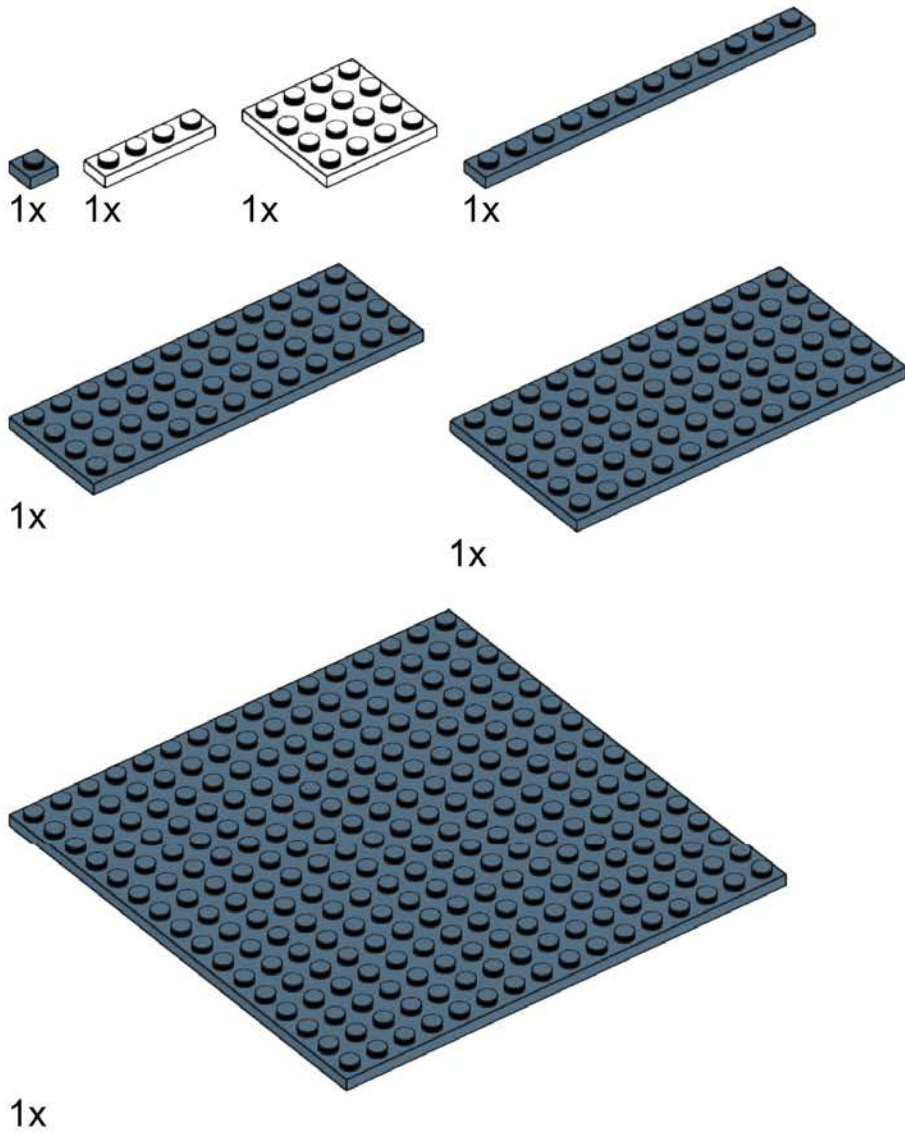

# 306

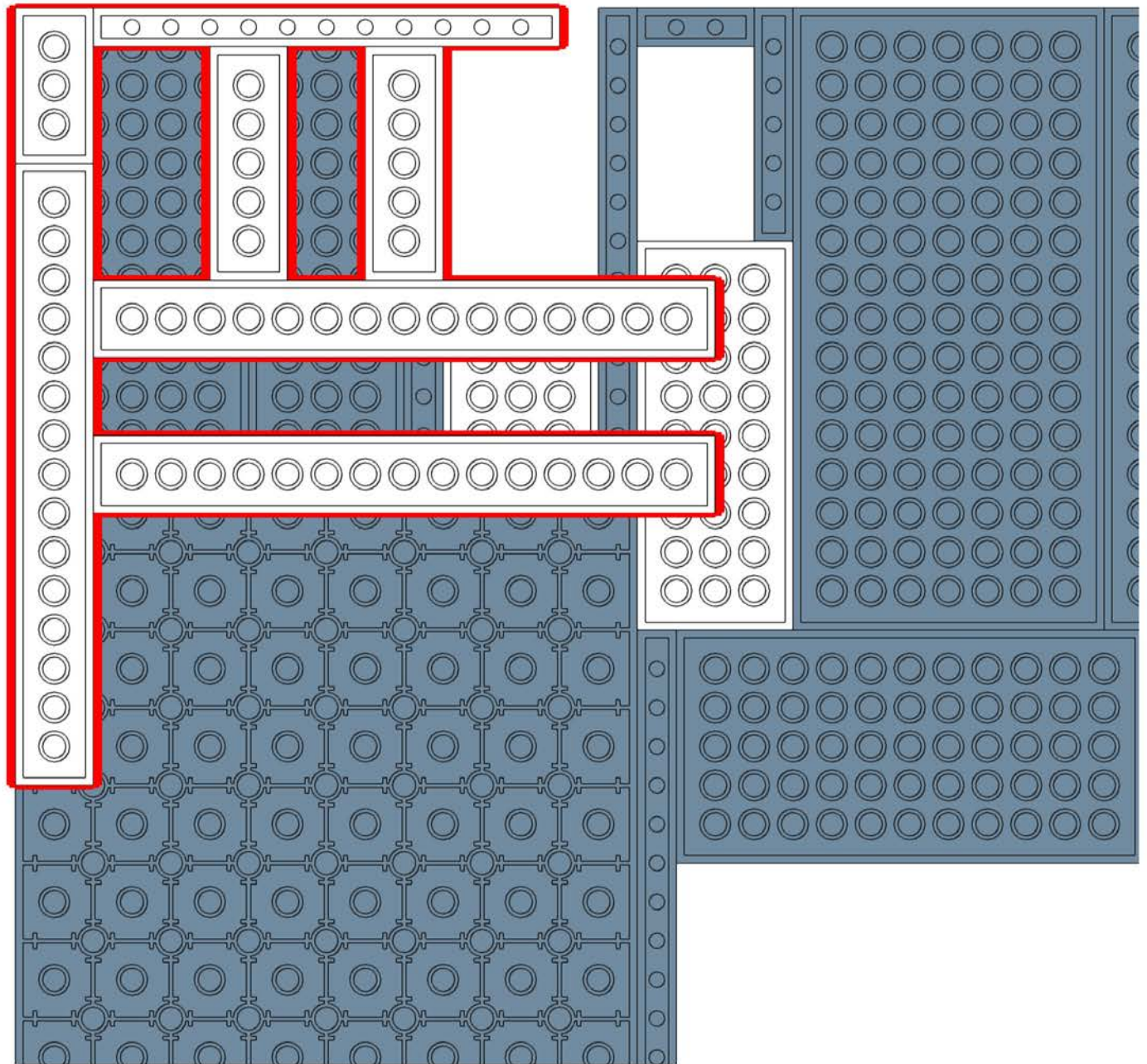
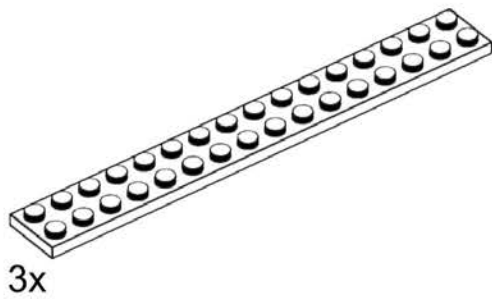
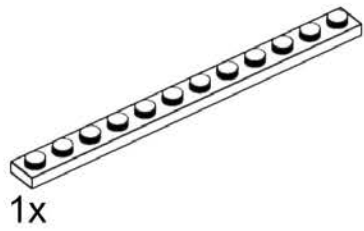
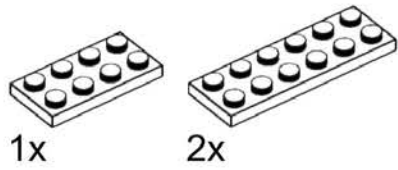



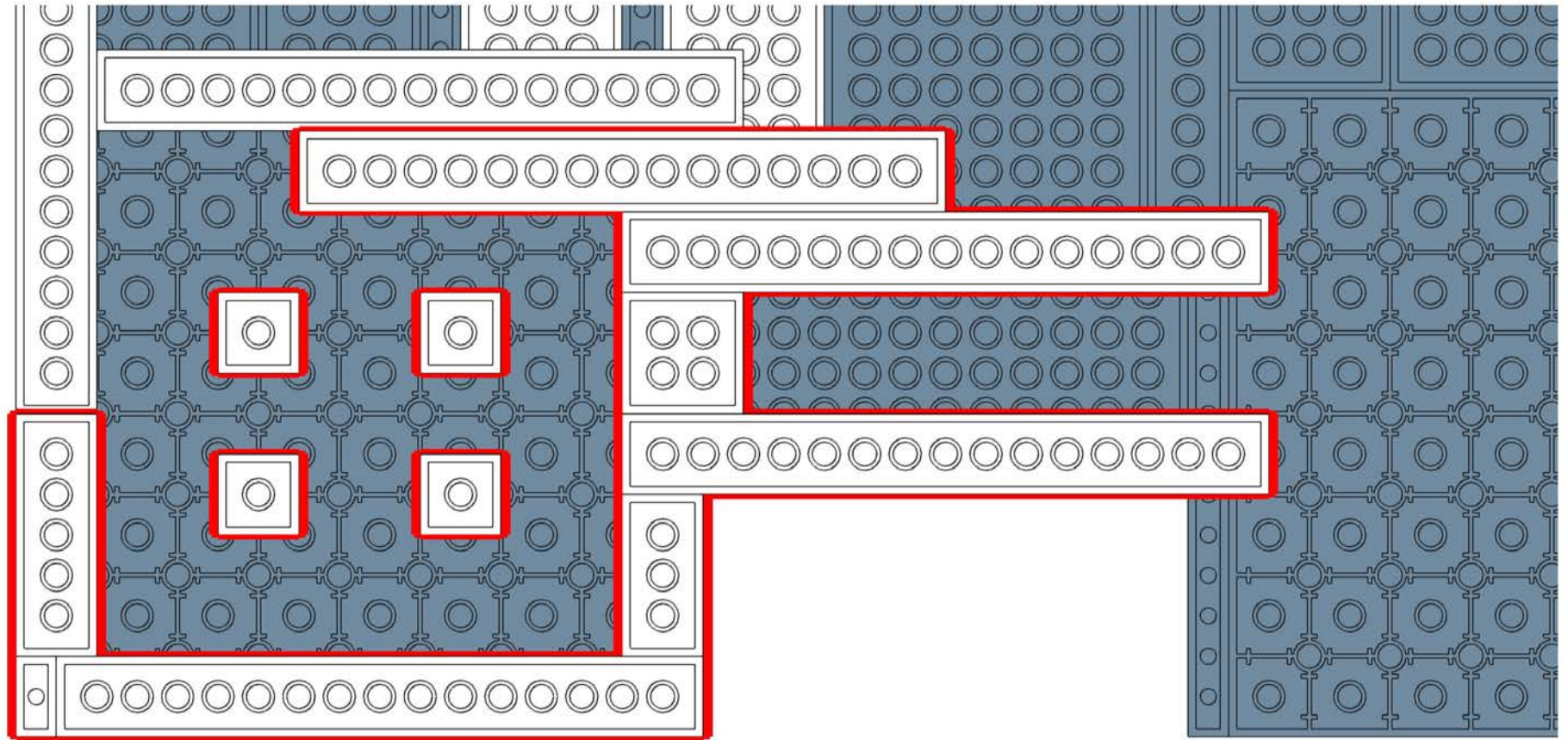

307

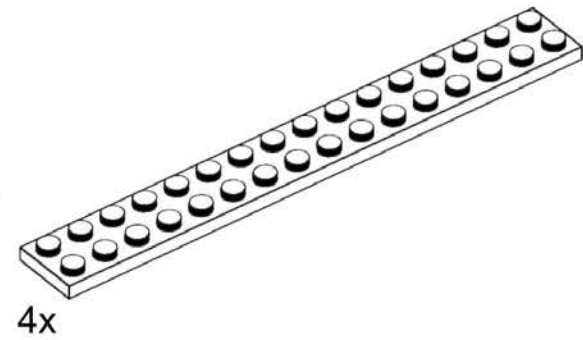
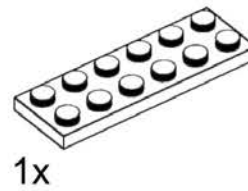
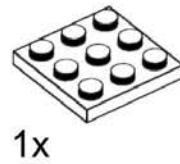
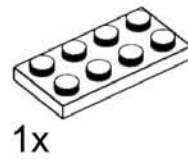
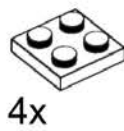
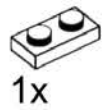

# 308

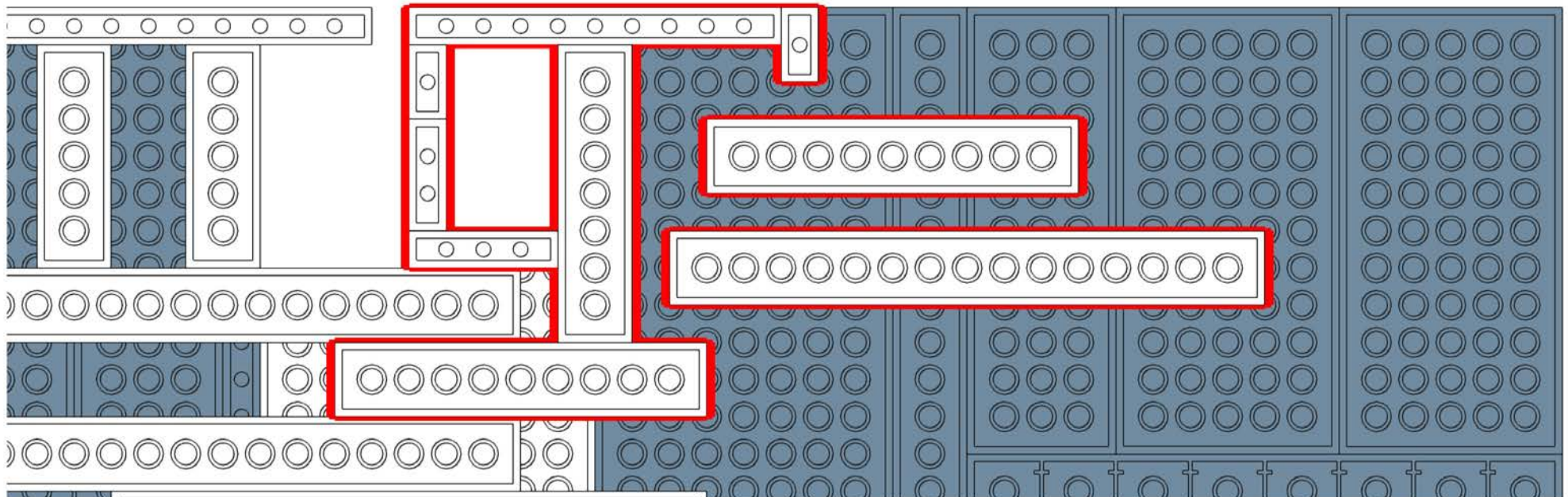
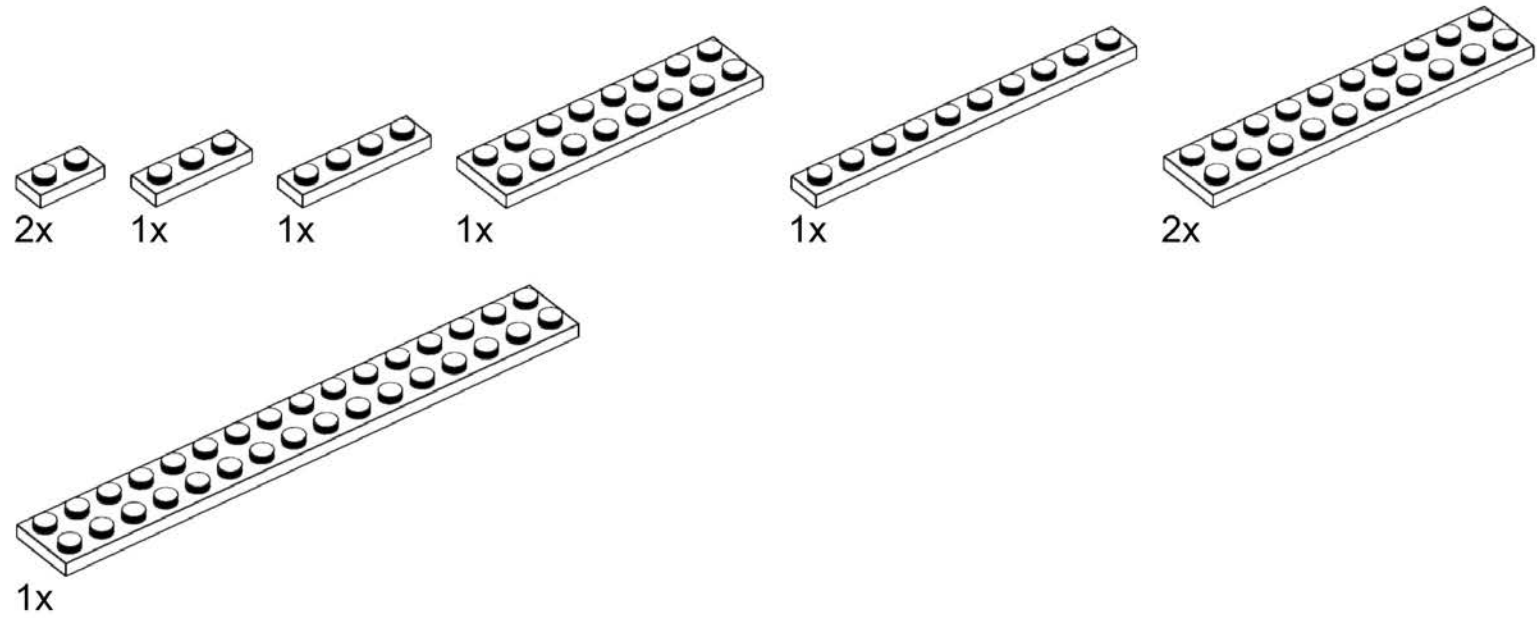

# 309

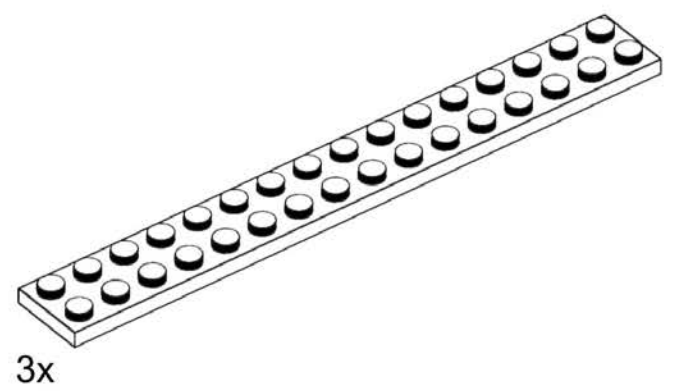
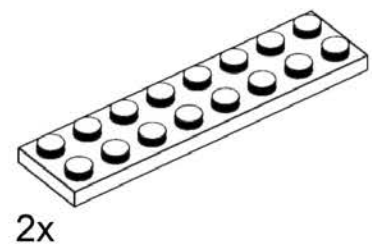
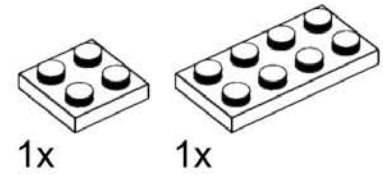
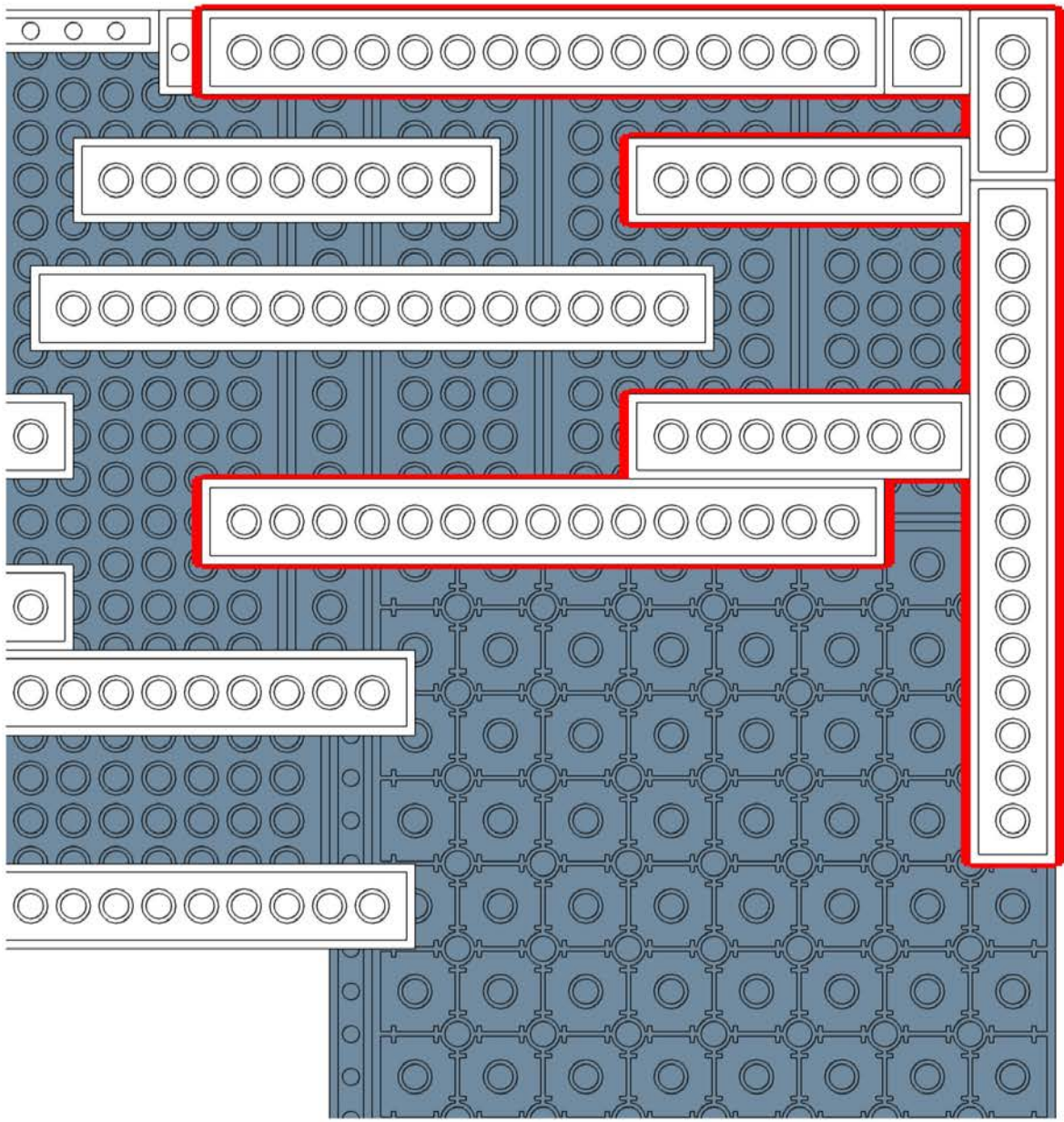

# 310

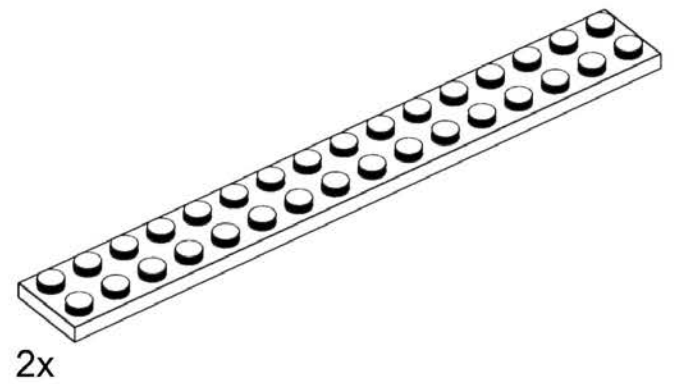
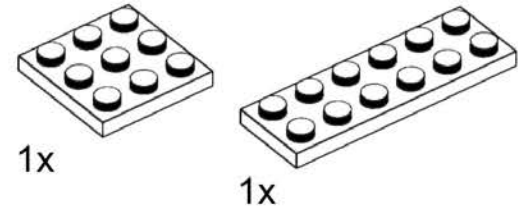
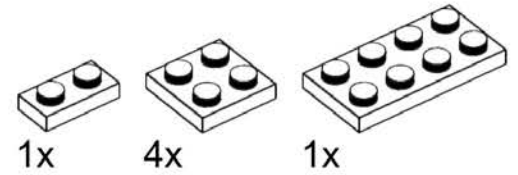
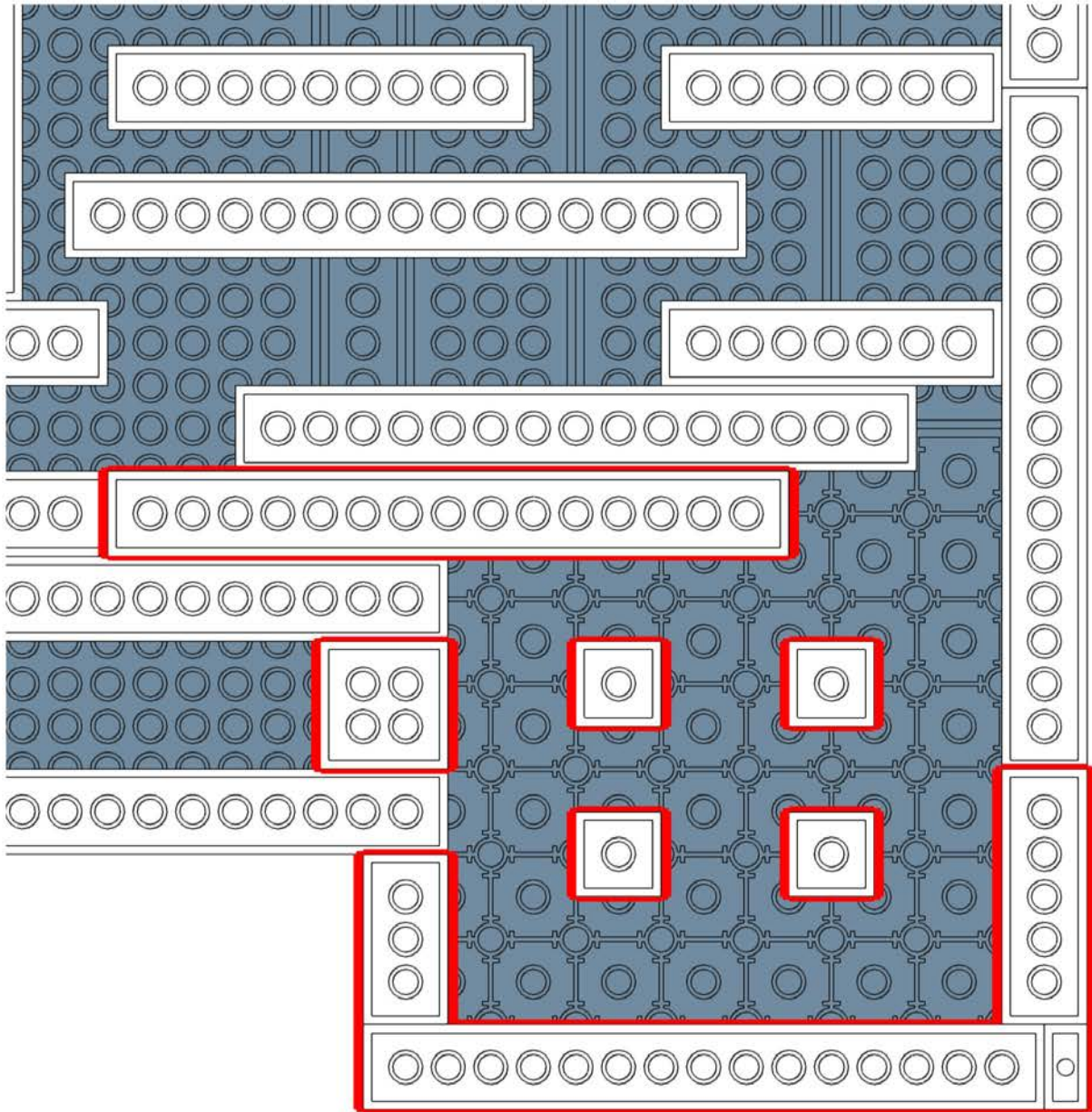

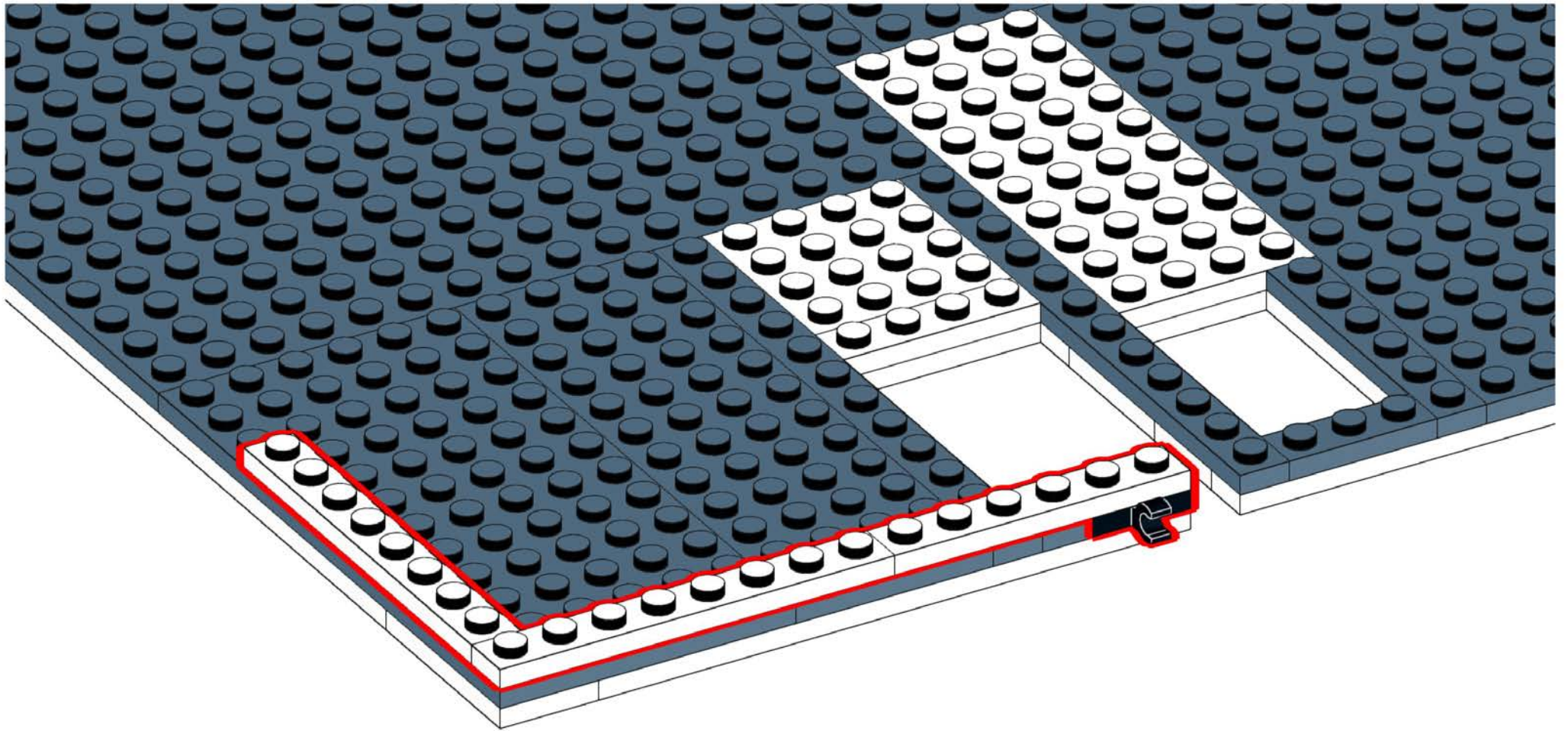

311



1x

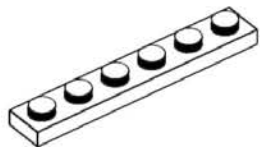

1x

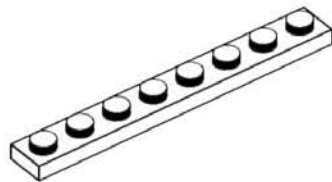

2x



# 312

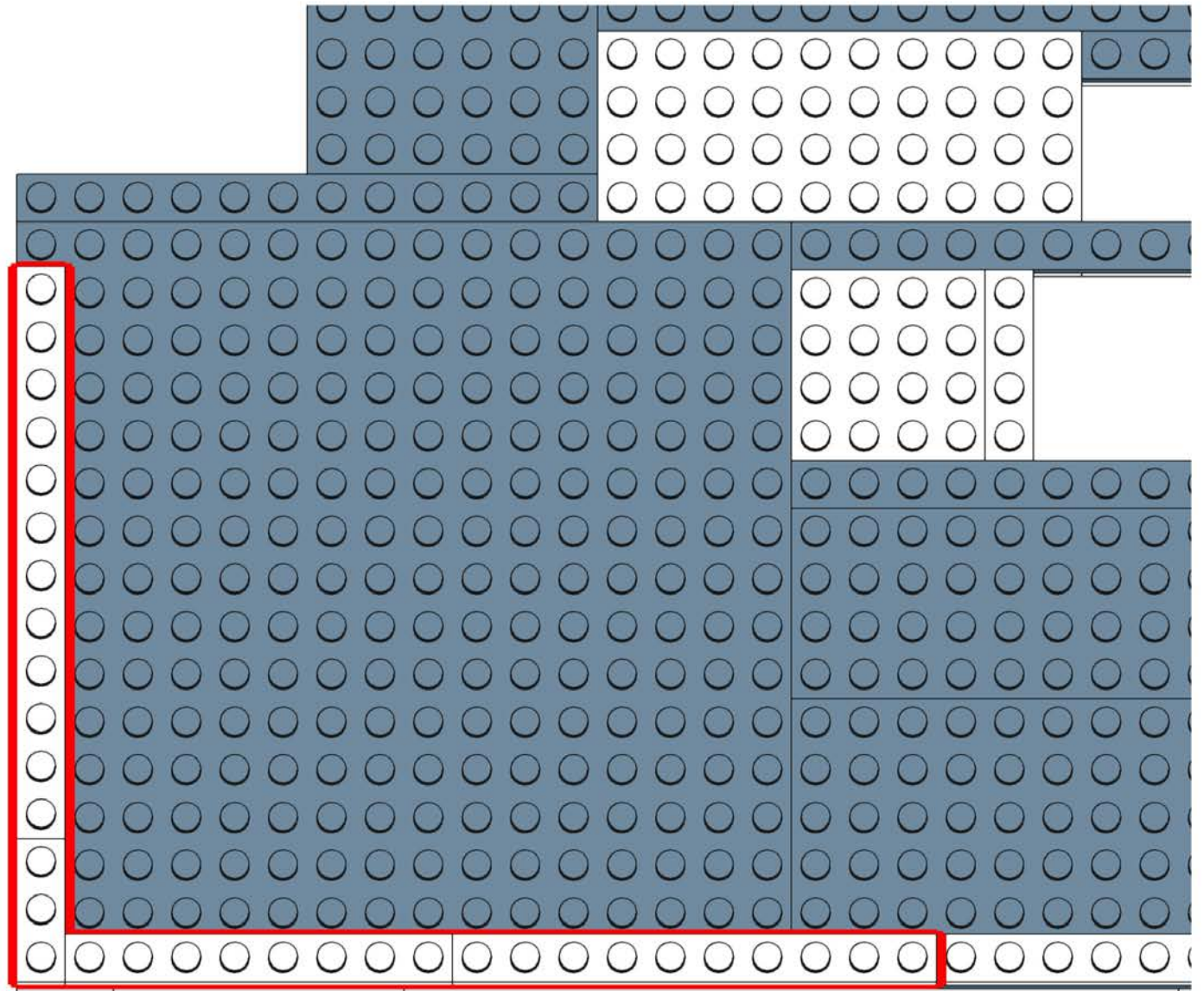
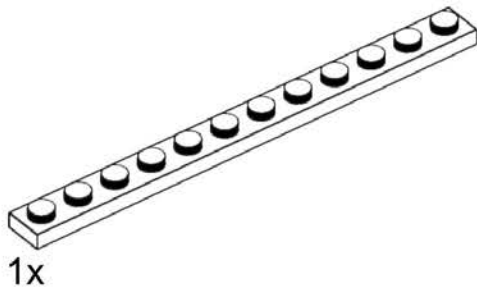
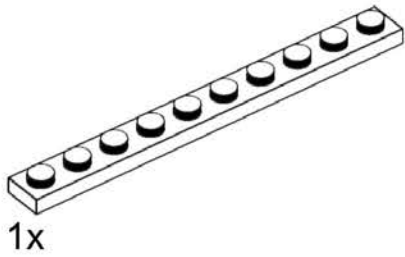
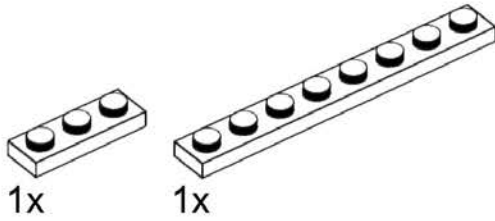

# 313

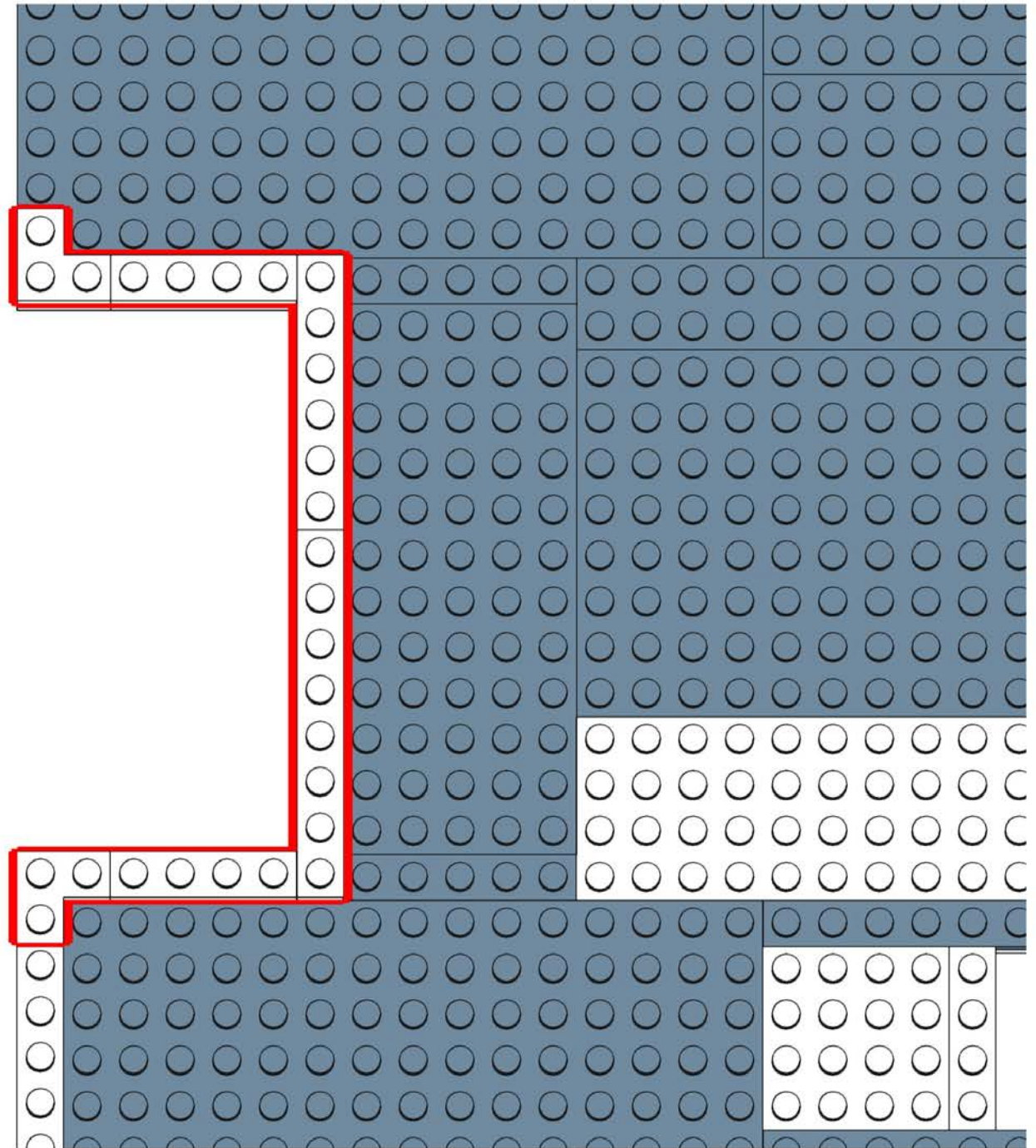
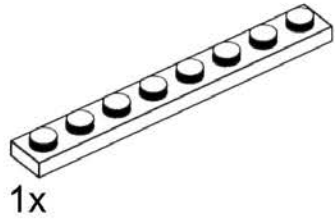
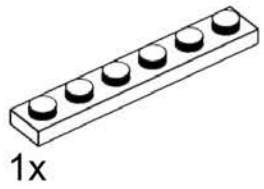
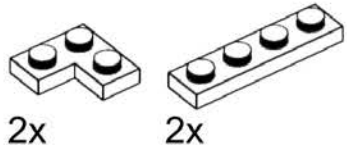

# 314

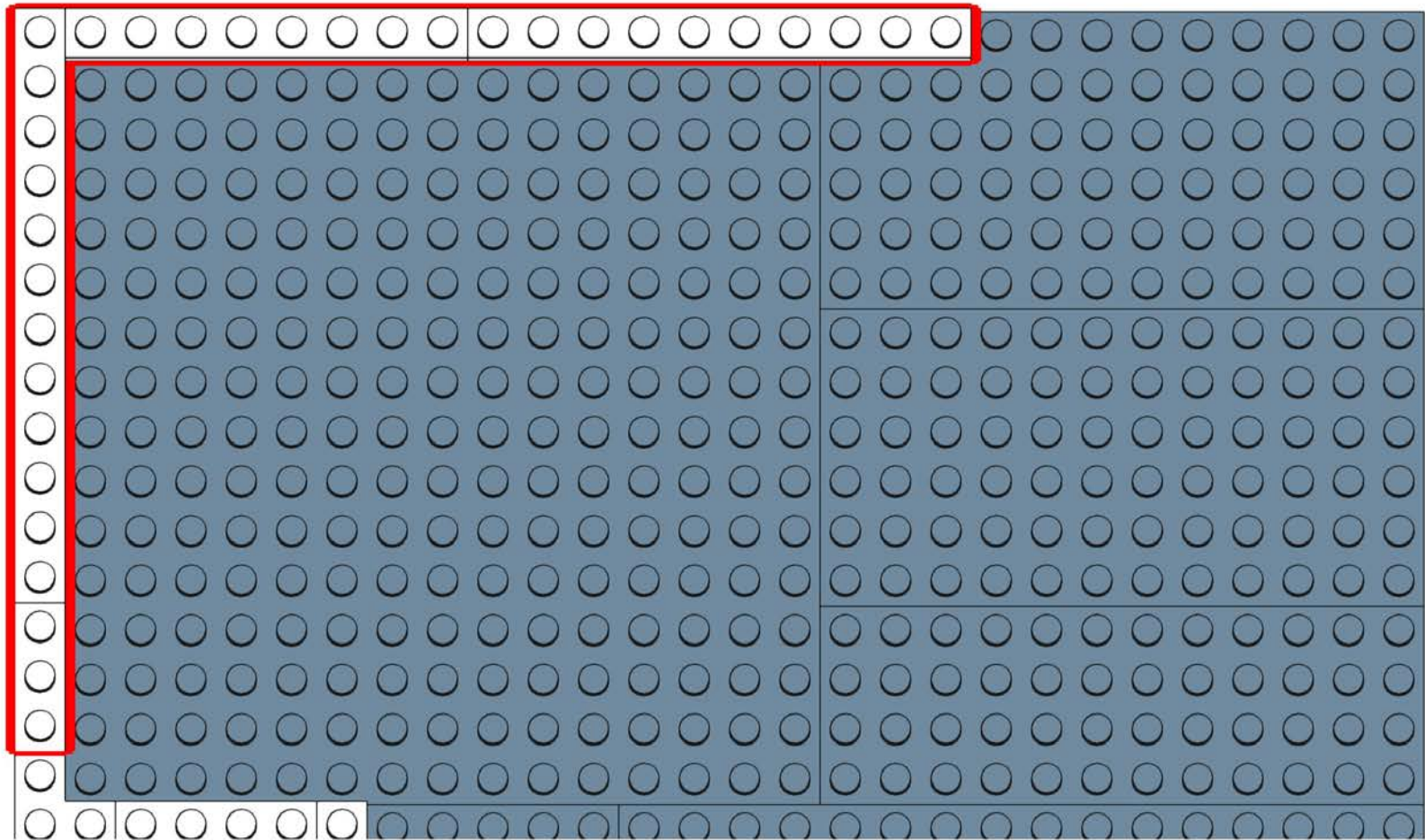
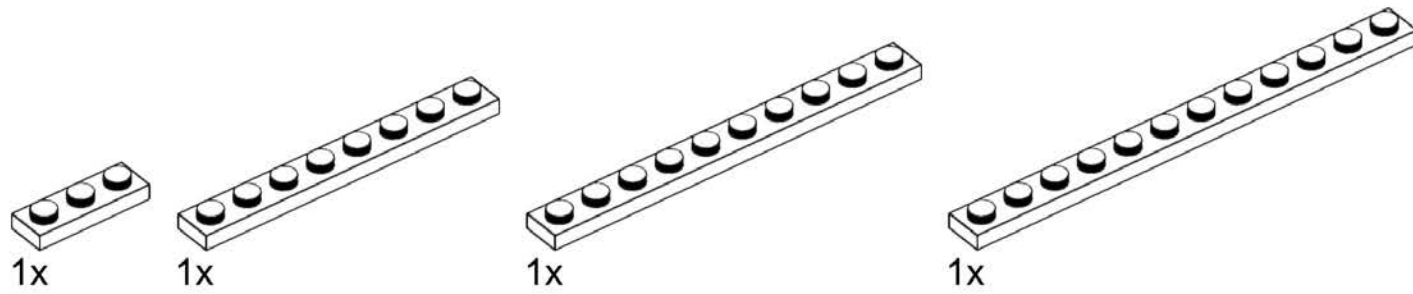



# 315

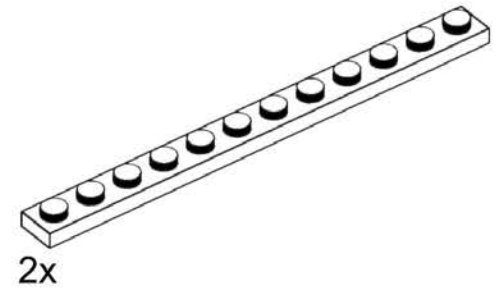
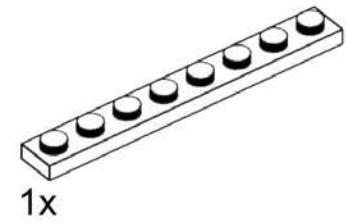
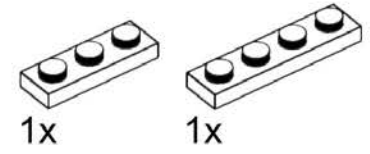
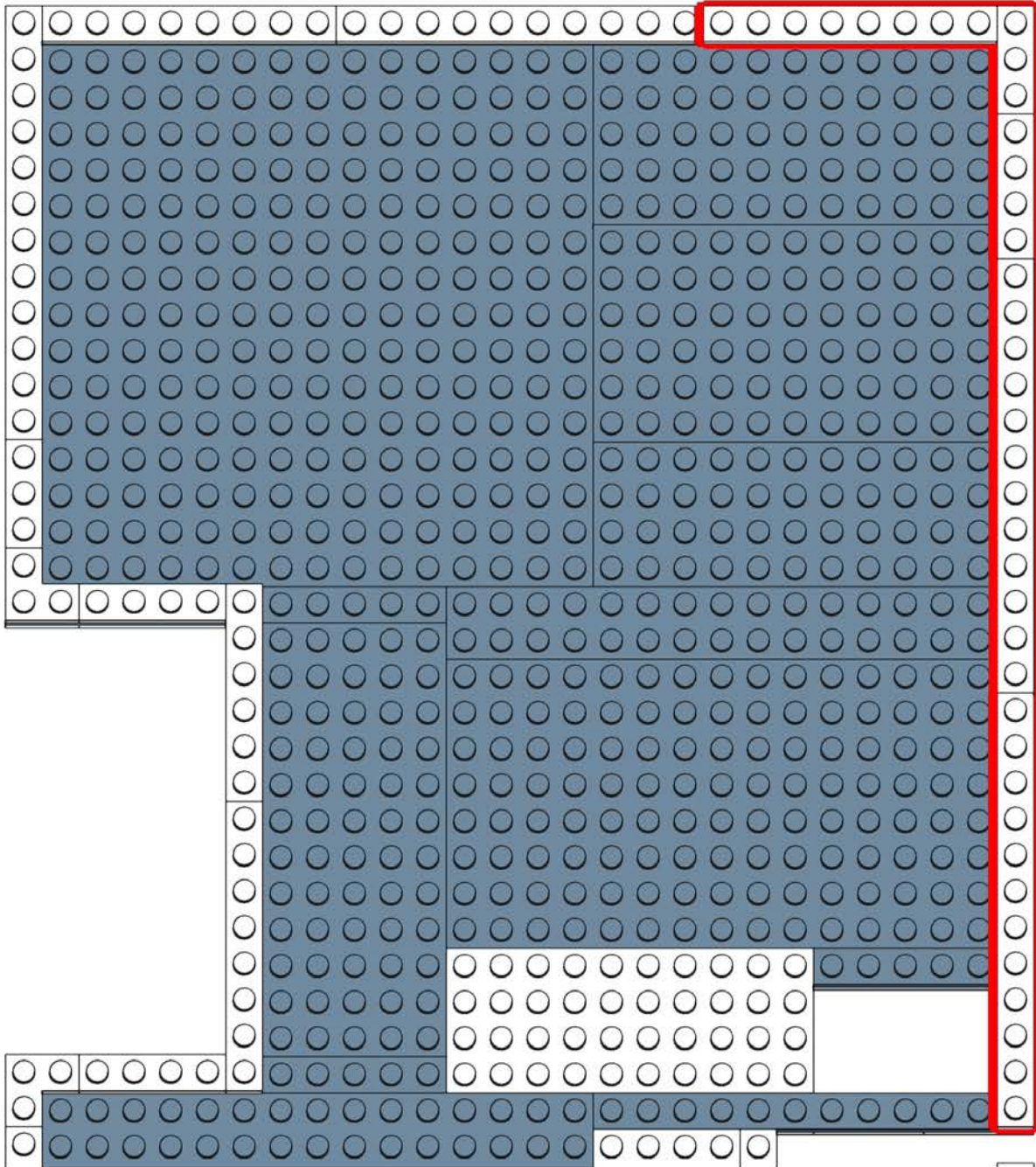

# 316

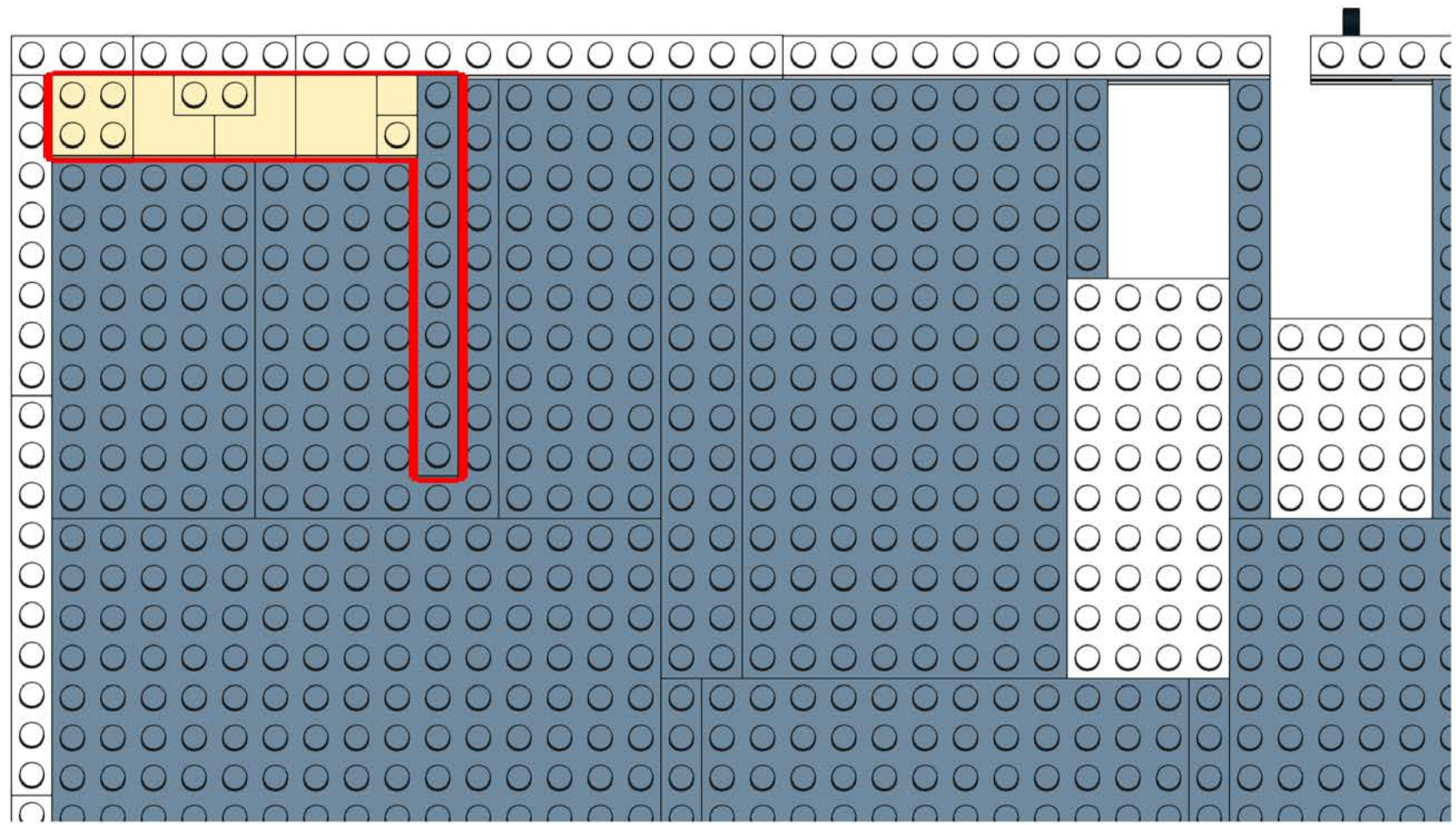
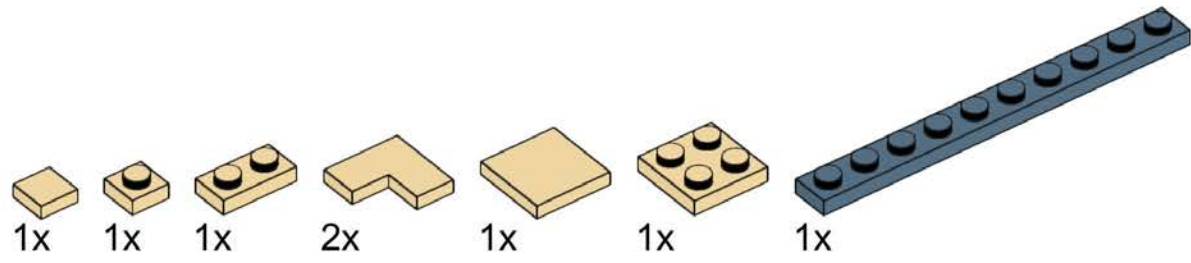

# 317

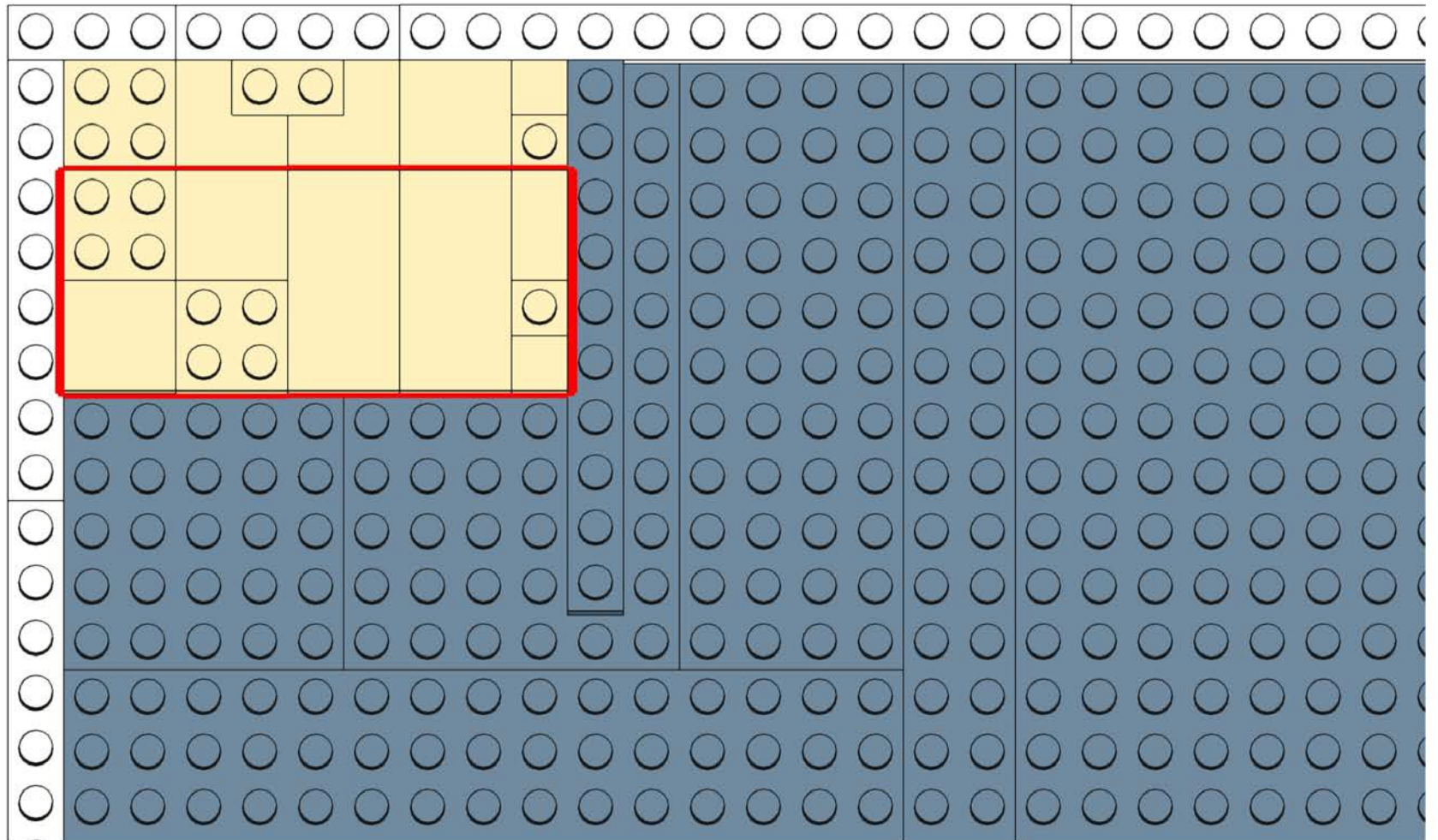
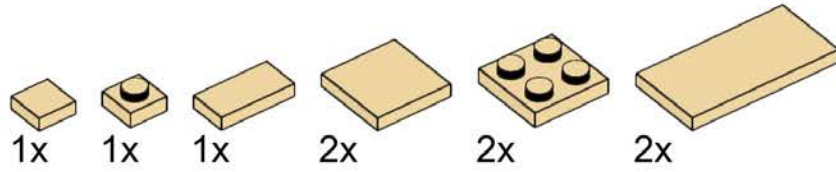

# 318

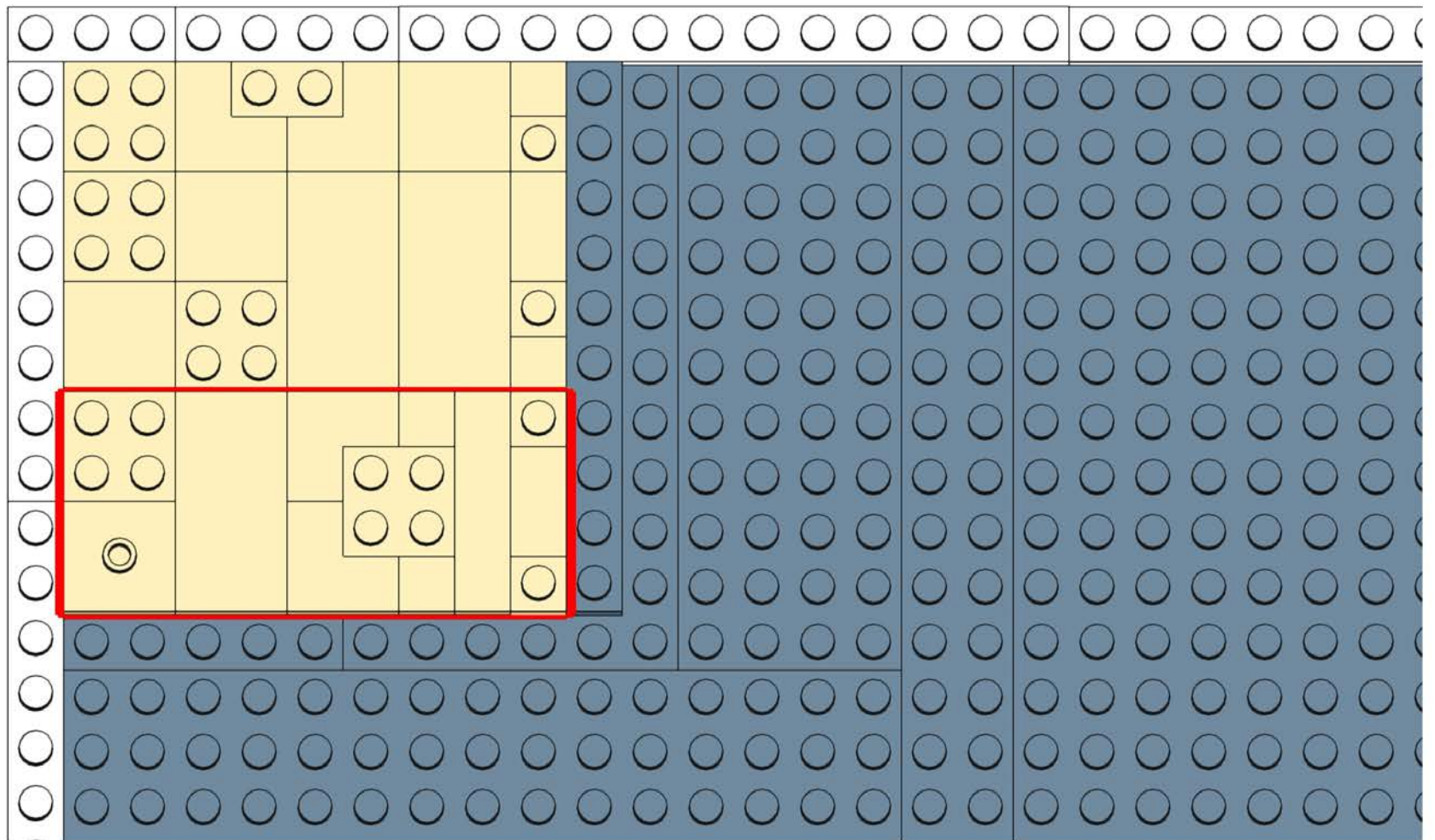
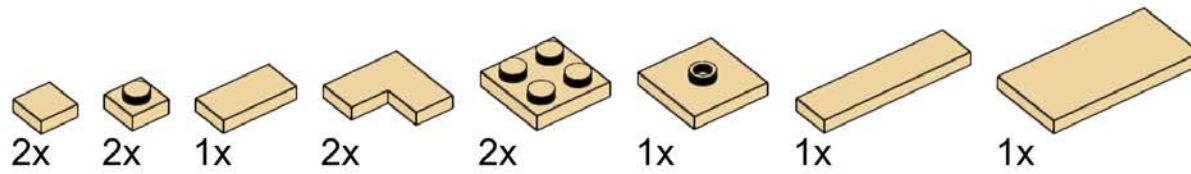

# 319

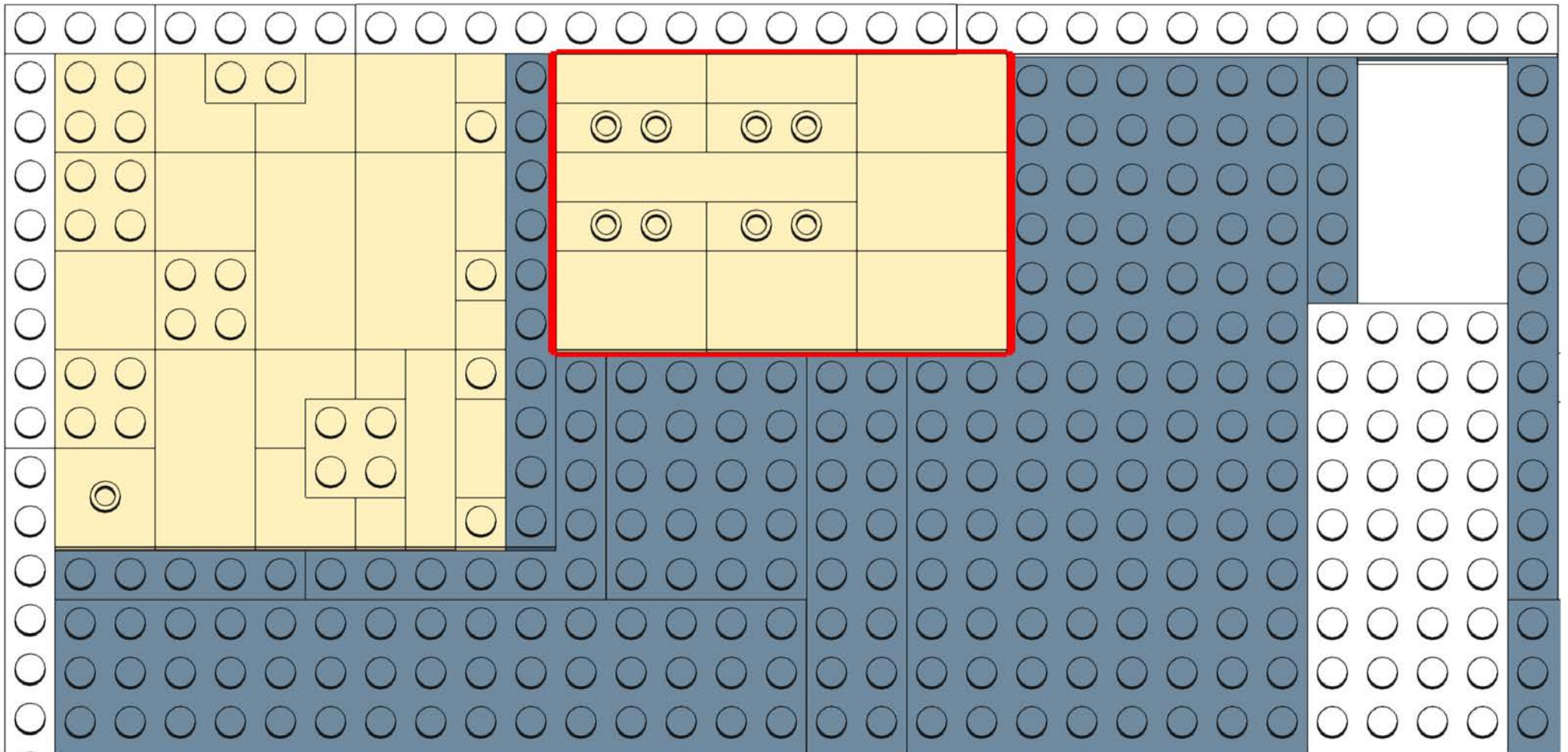
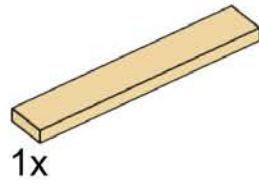
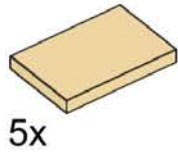
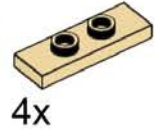
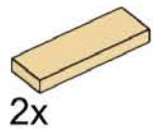

# 320

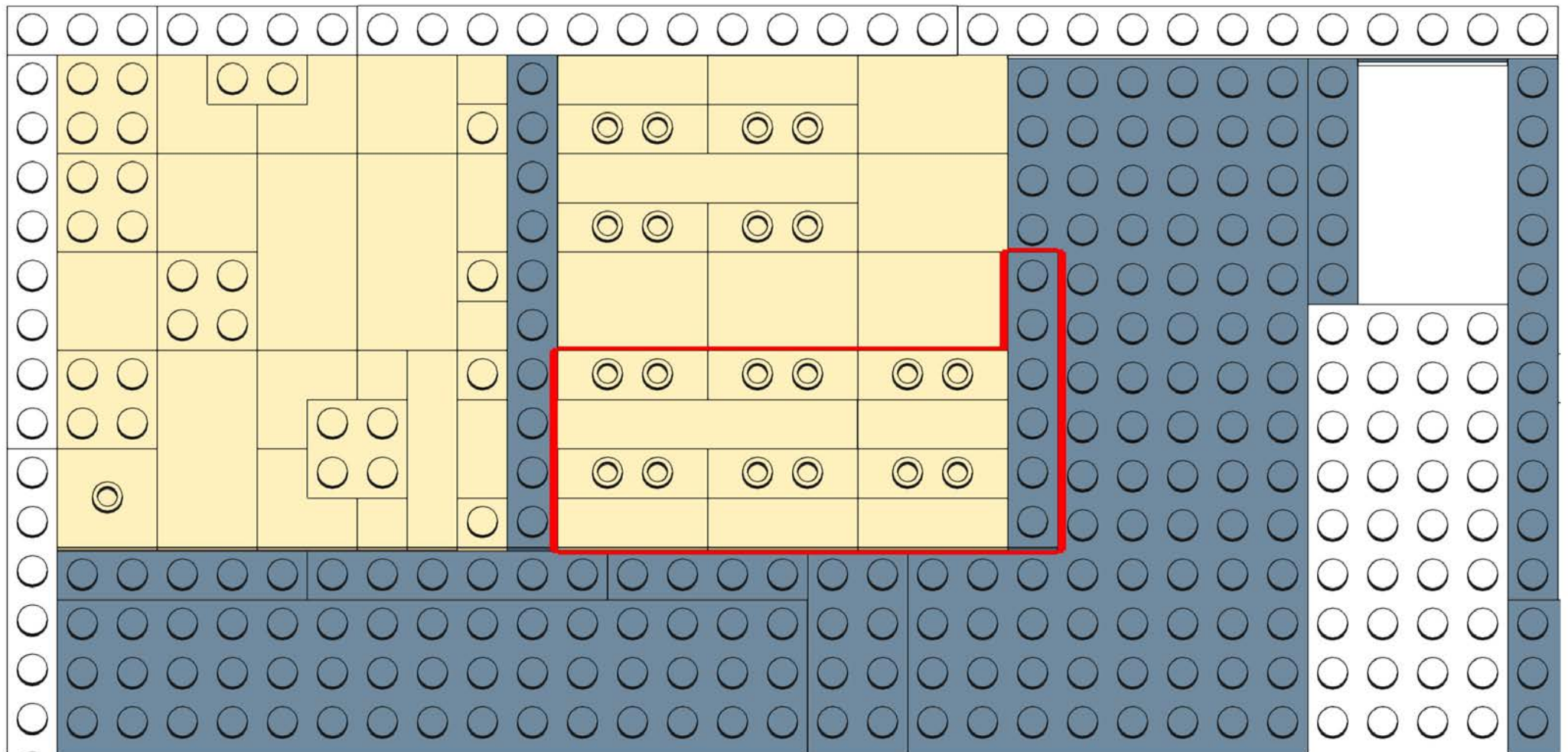
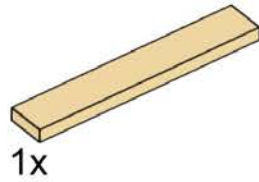
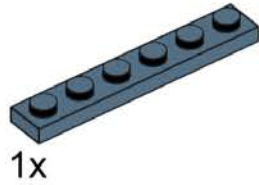
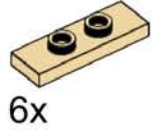
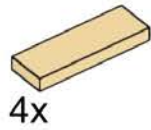

# 321

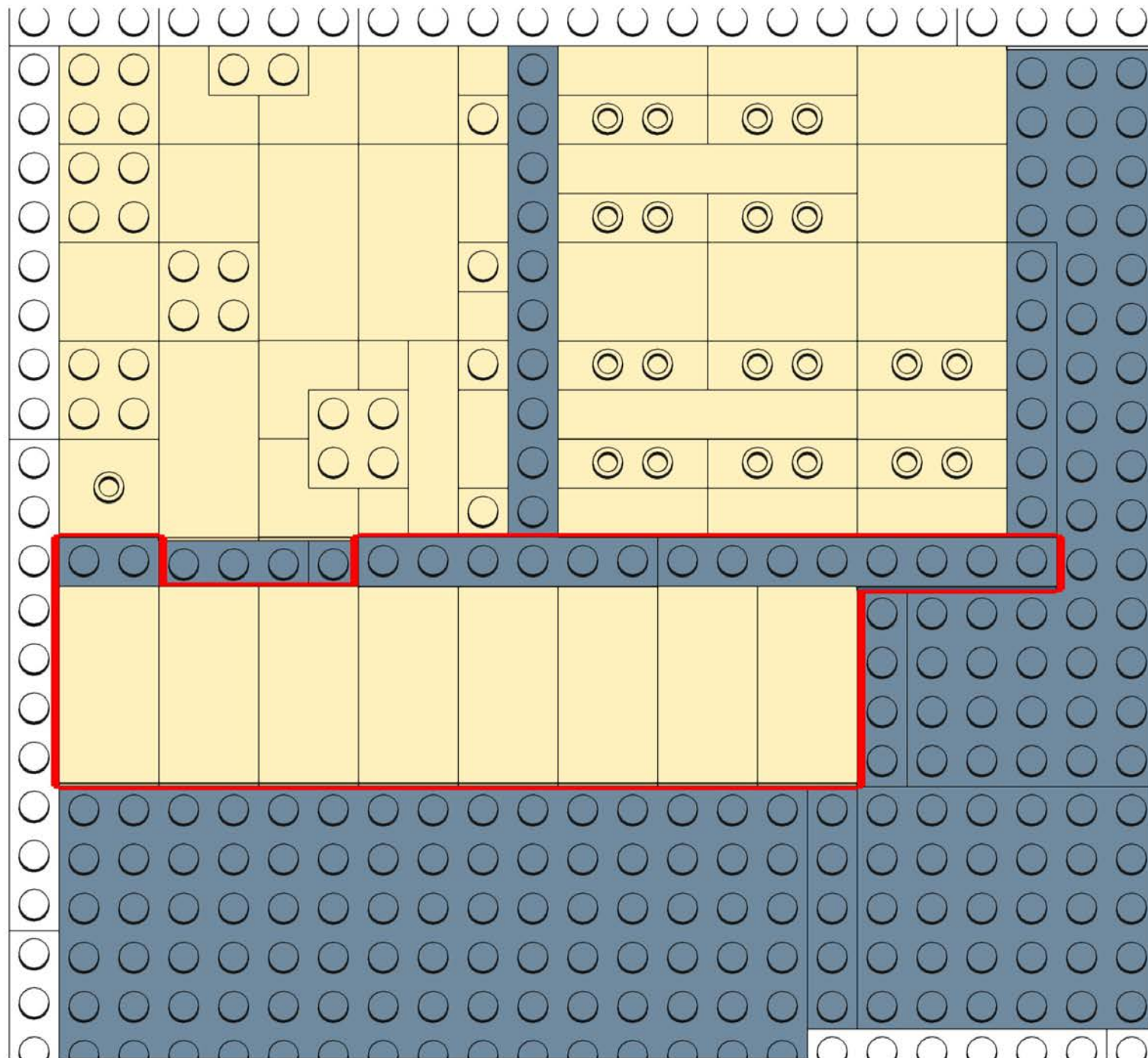
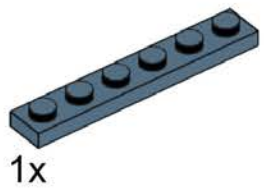
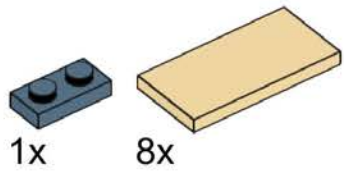

# 322

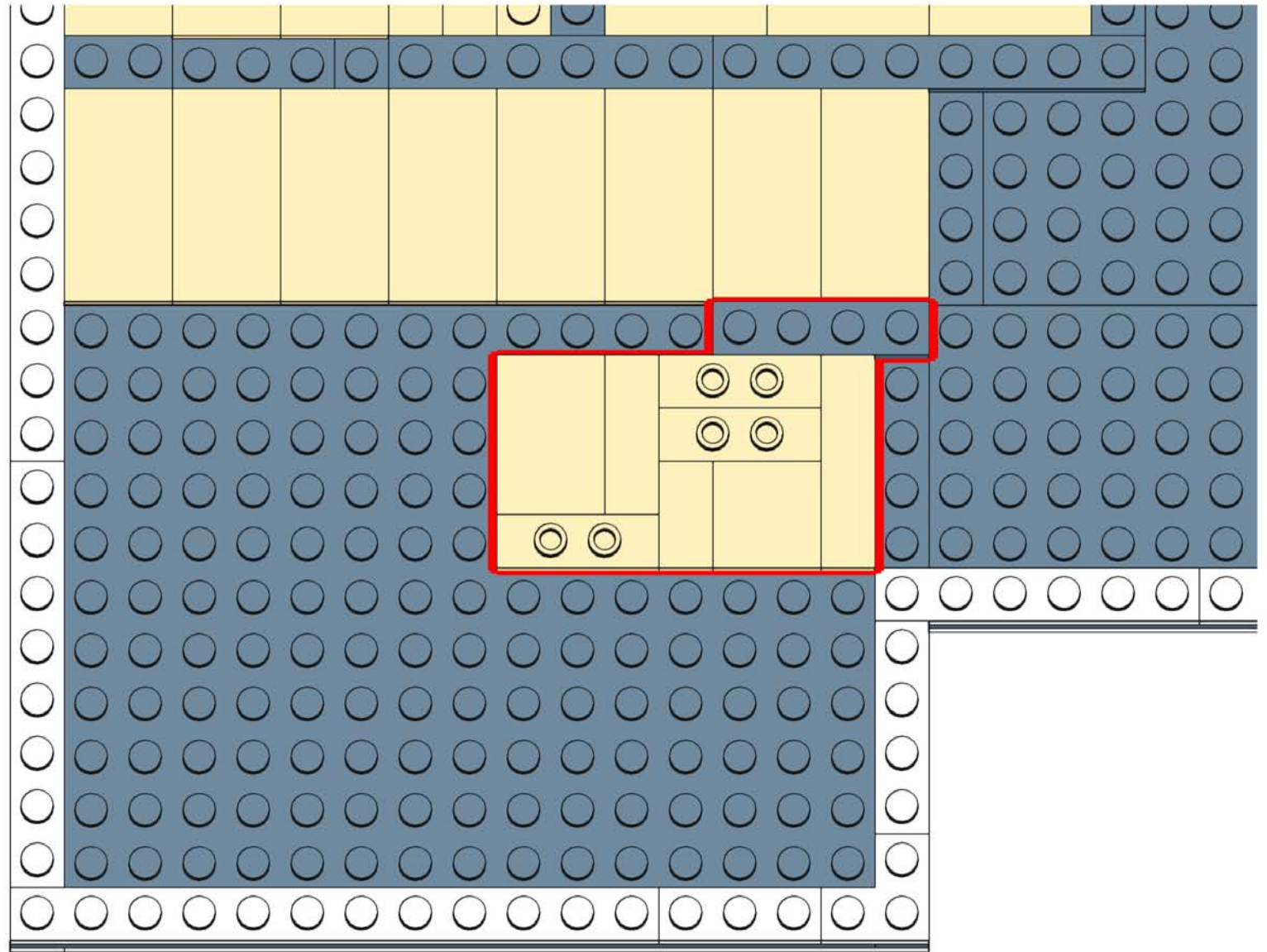
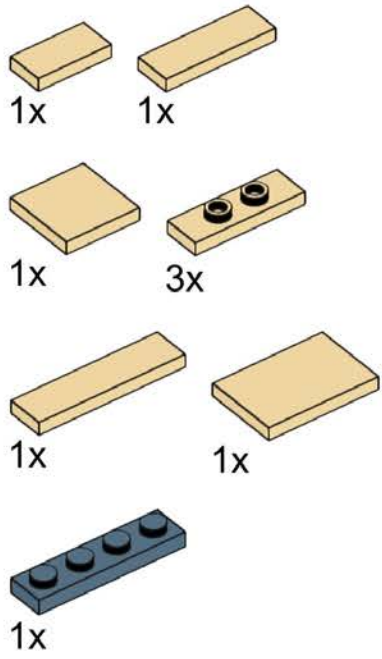



# 323

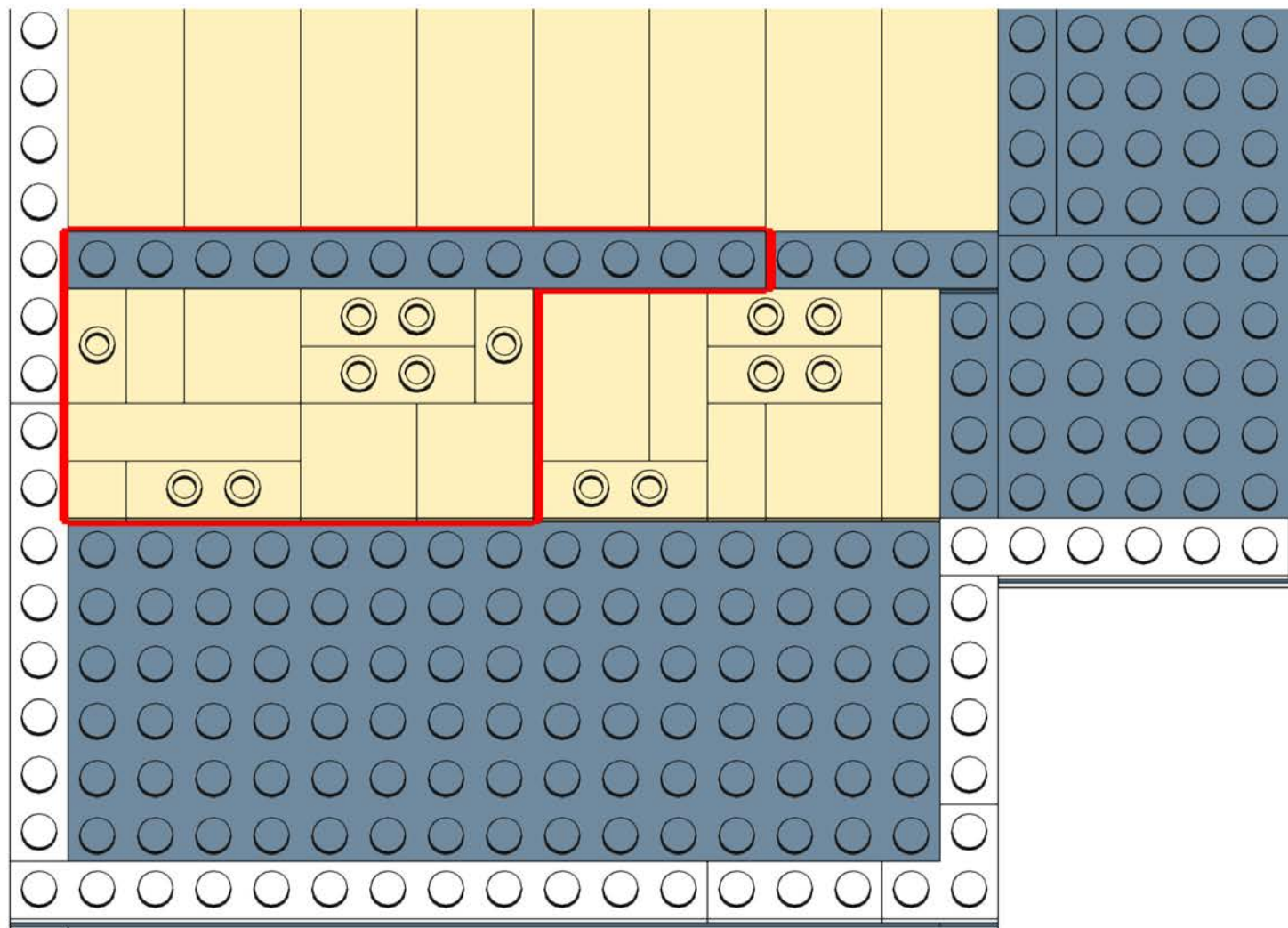
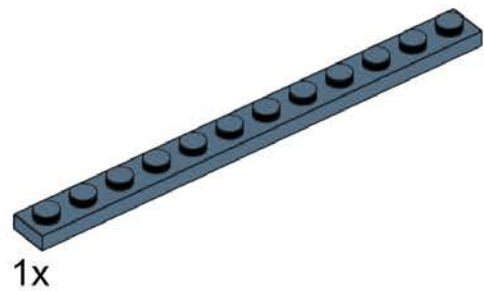
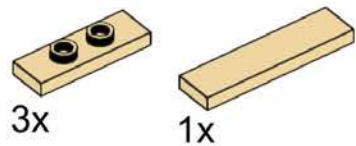
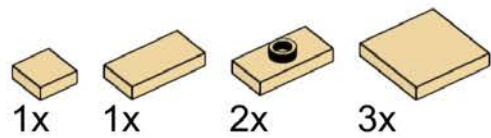

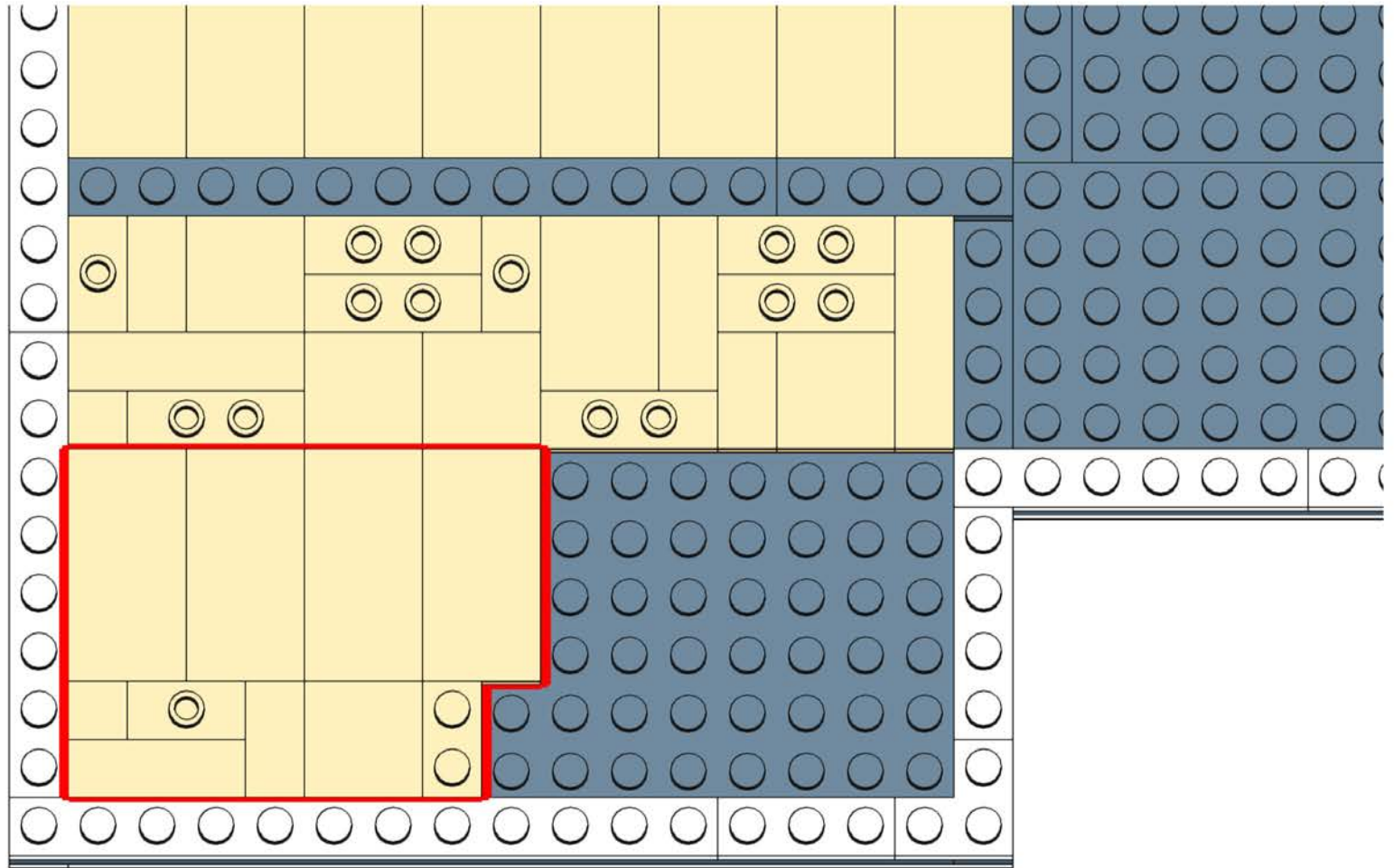

324

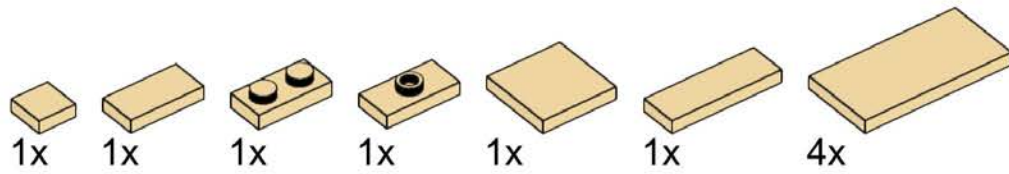

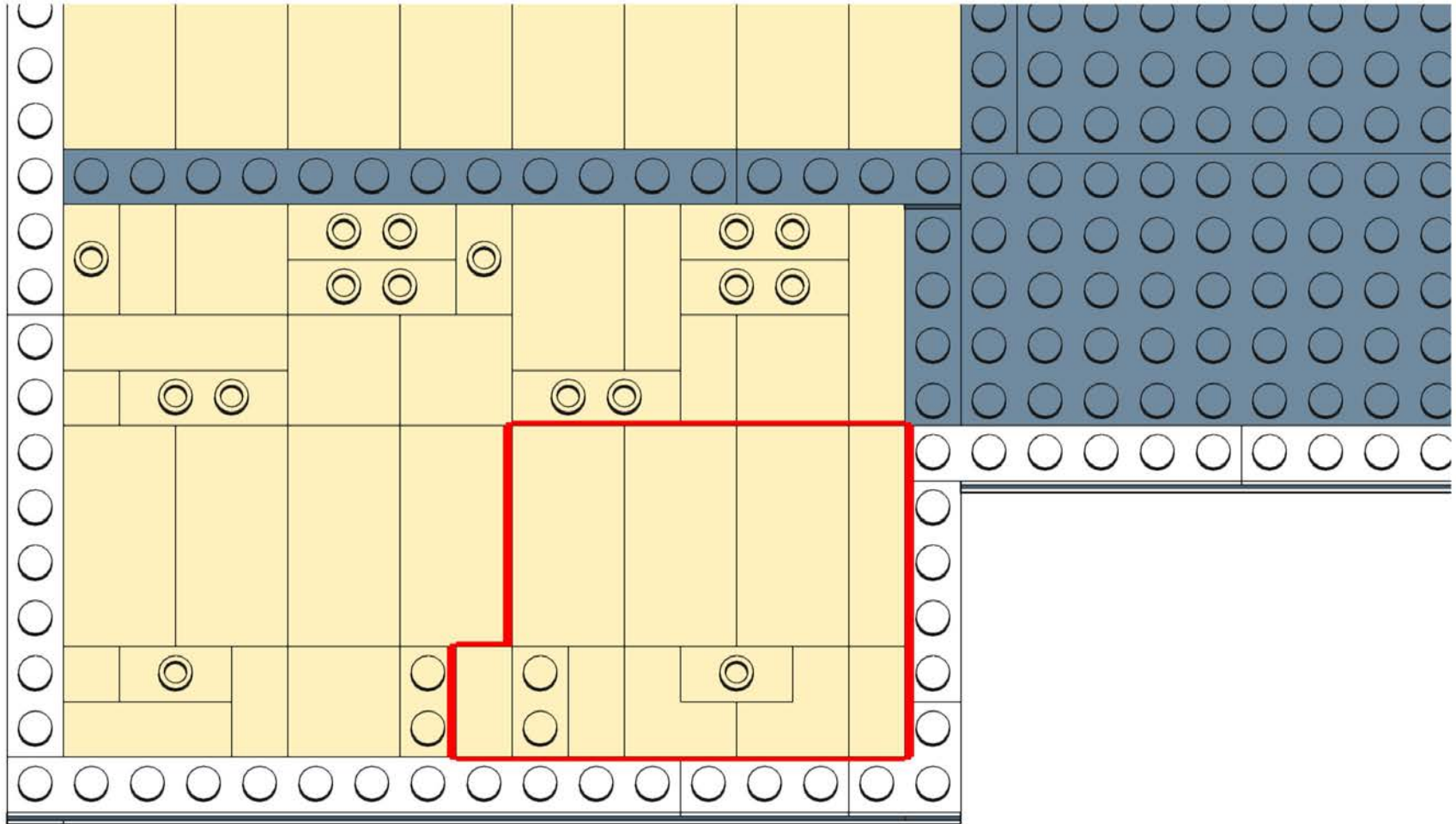

**325**

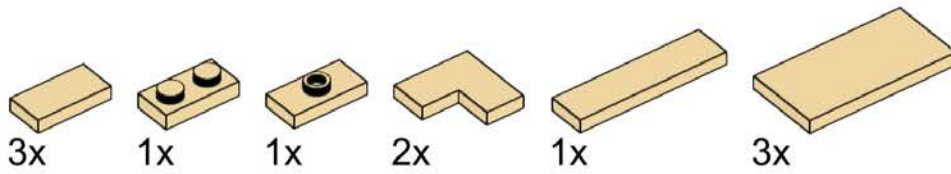

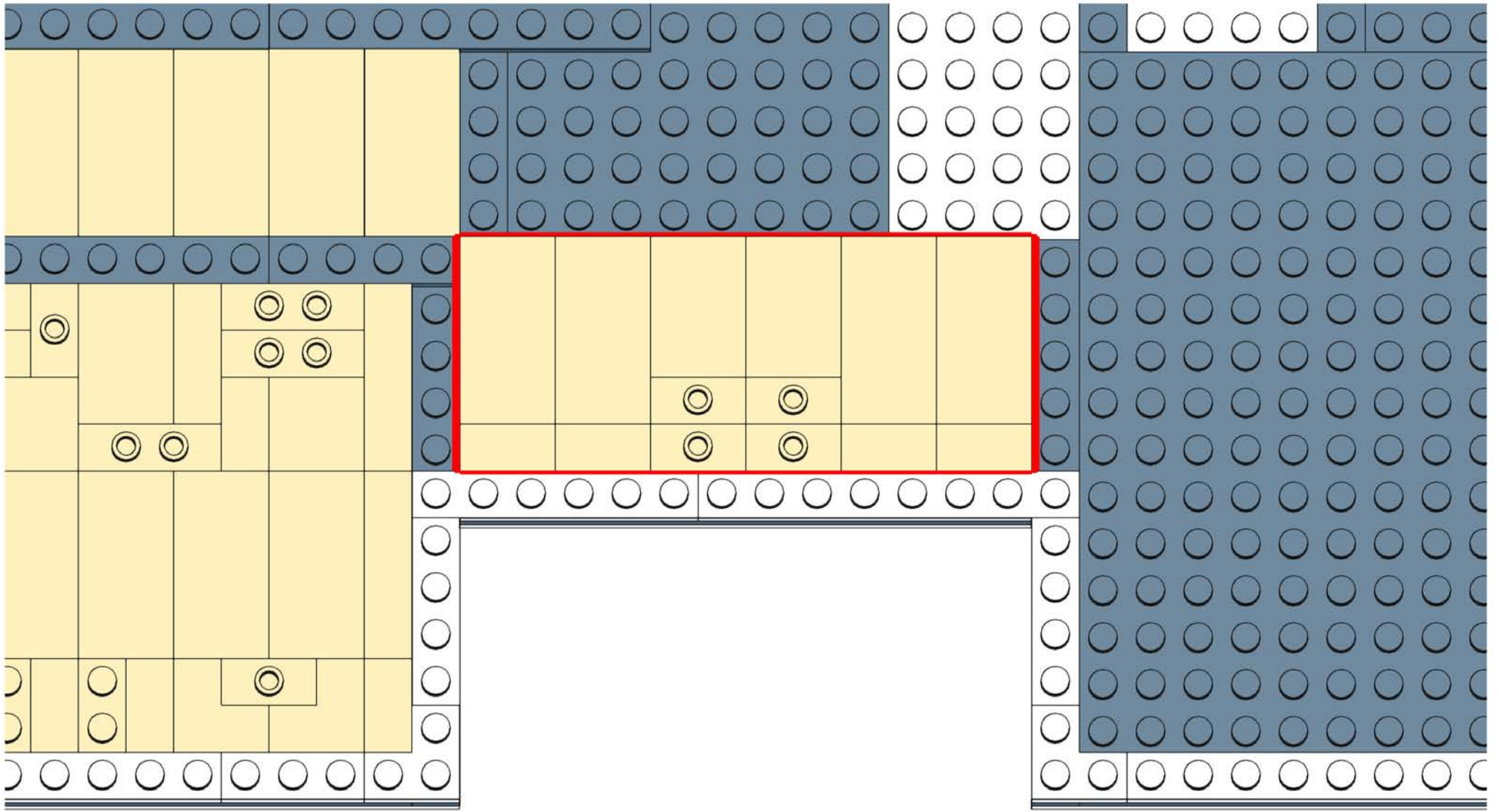

**326**



4x



4x



2x

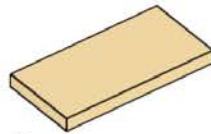

4x

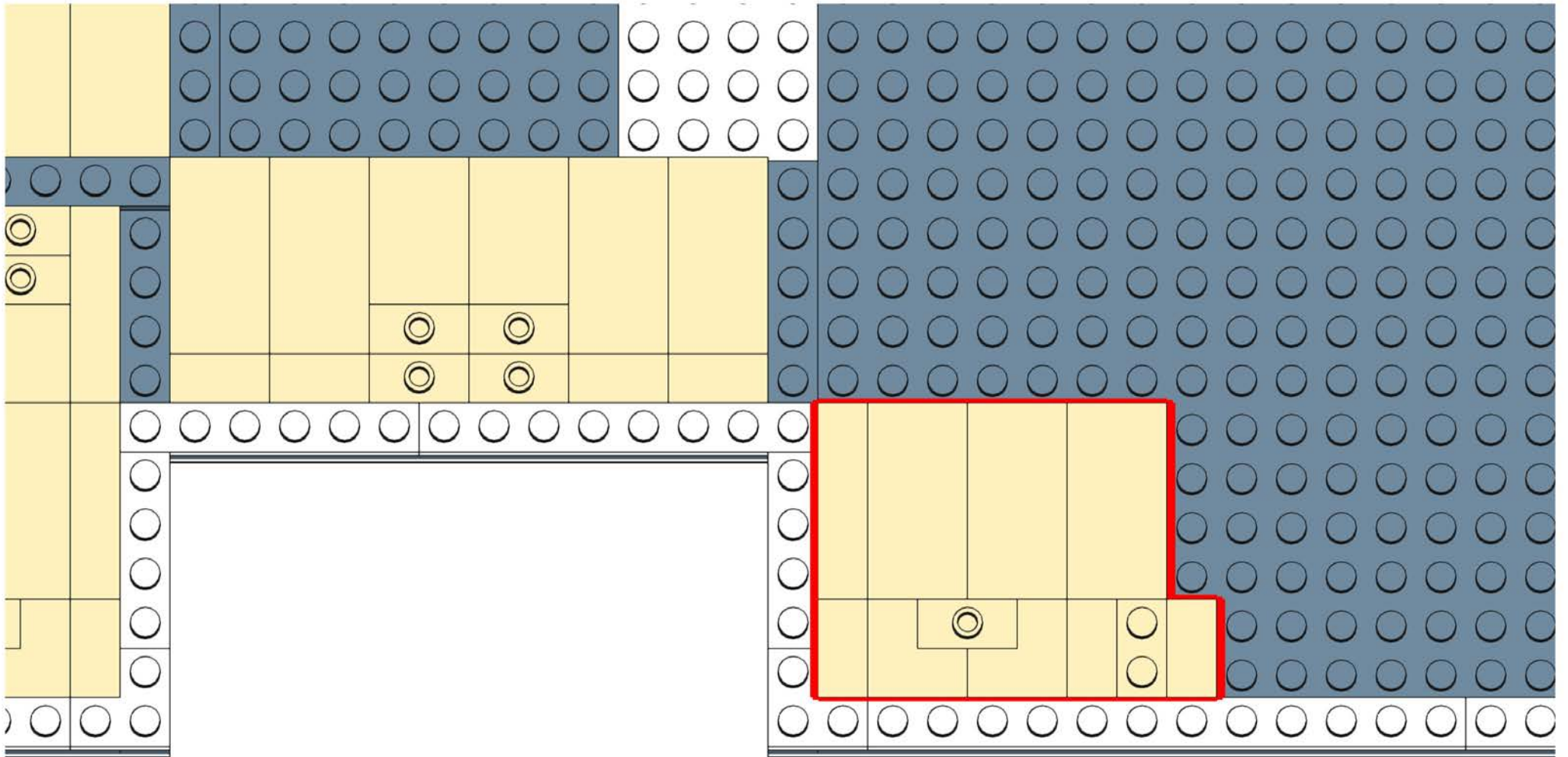

**327**

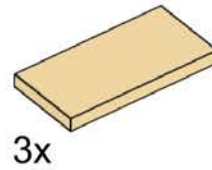
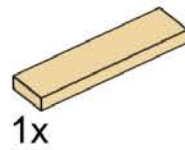
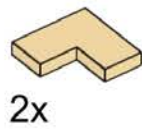
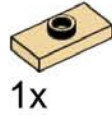
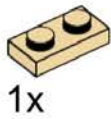
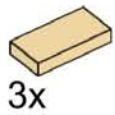

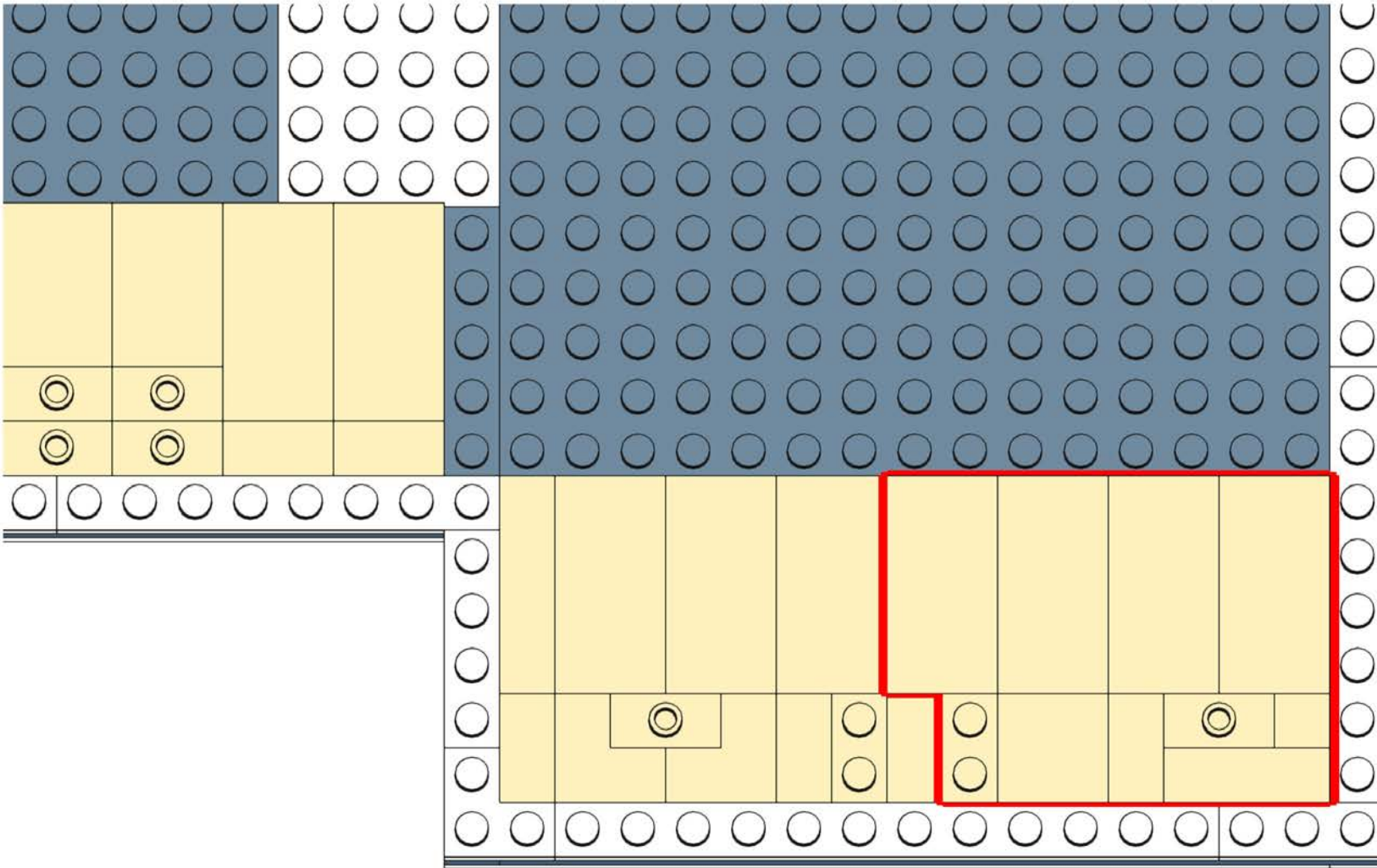

**328**

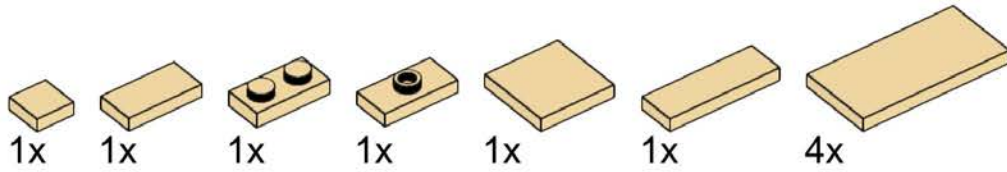

# 329

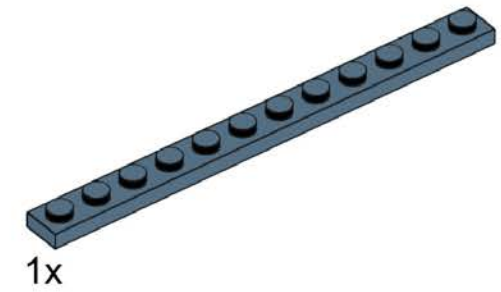
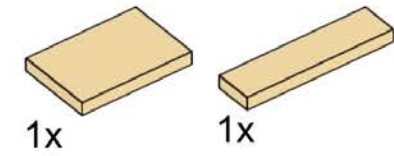
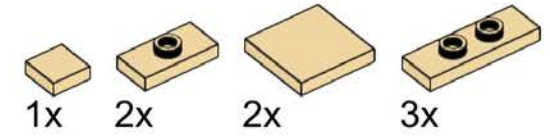
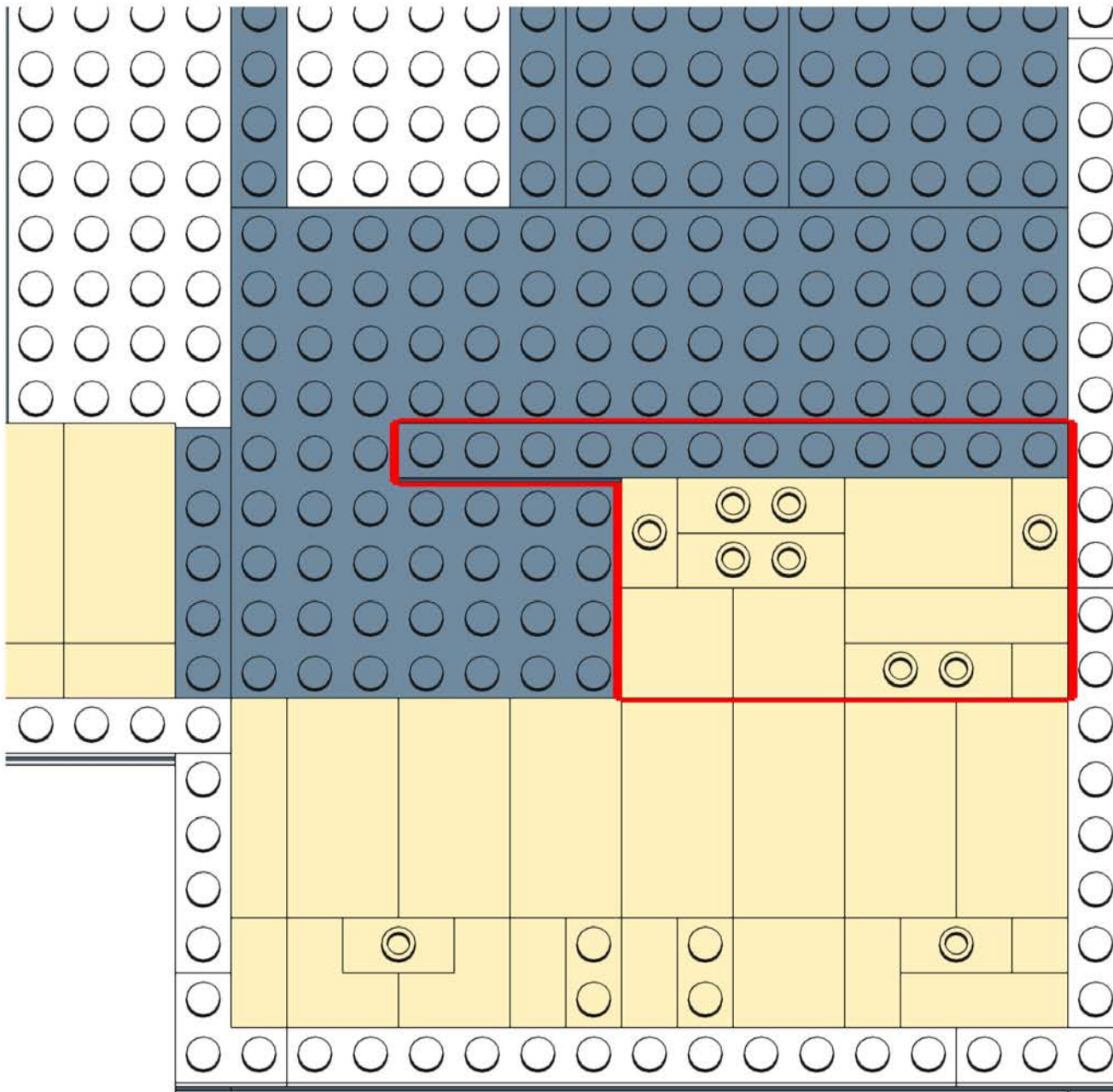

# 330

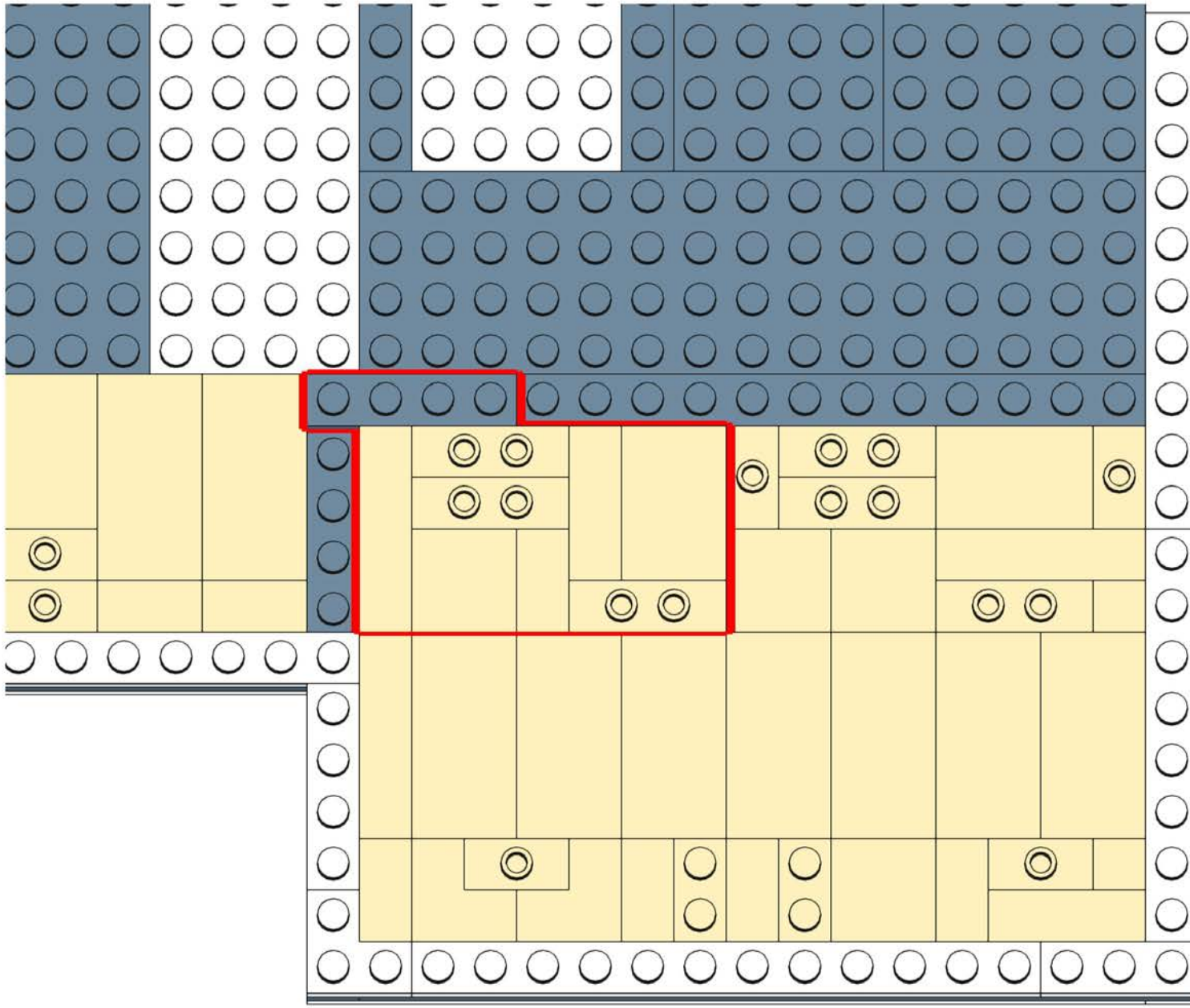

- 1x 1x
- 1x 1x
- 1x 1x
- 3x 1x
- 1x 1x
- 1x 1x
- 1x 1x



# 331

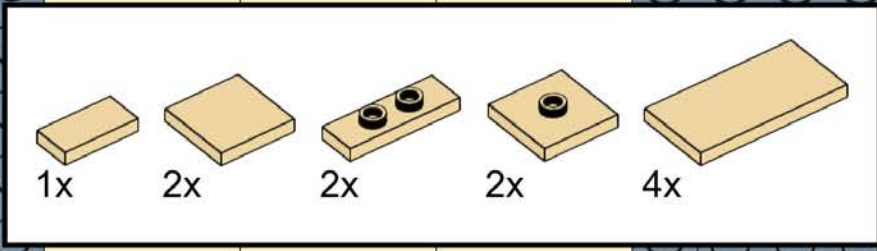

1x 2x 2x 2x 4x

This block contains a list of five yellow Technic parts with their respective quantities: 1x 1x3 Technic brick, 2x 1x4 Technic brick, 2x 1x3 Technic brick with two holes, 2x 1x4 Technic brick with one hole, and 4x 1x6 Technic brick.

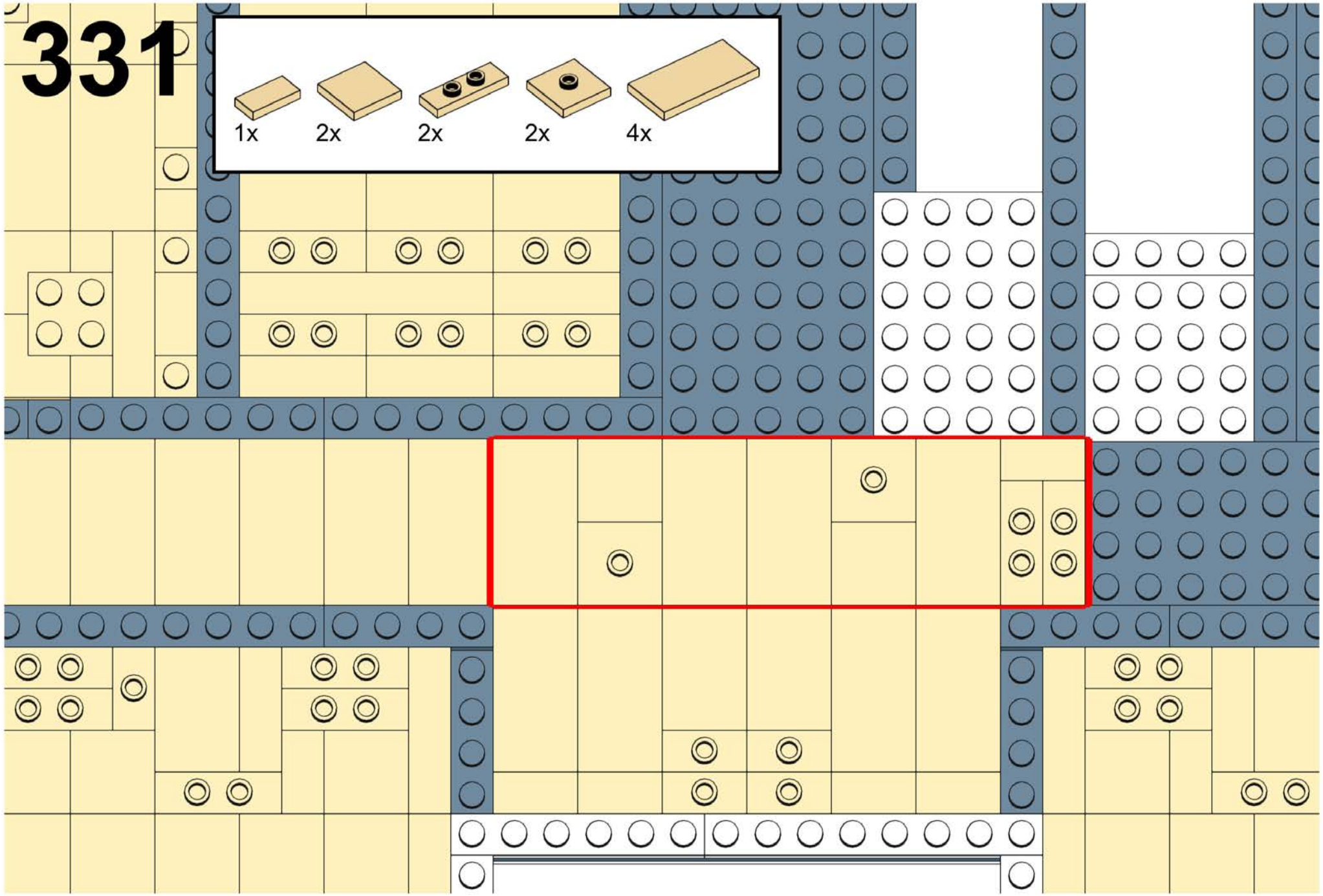

# 332

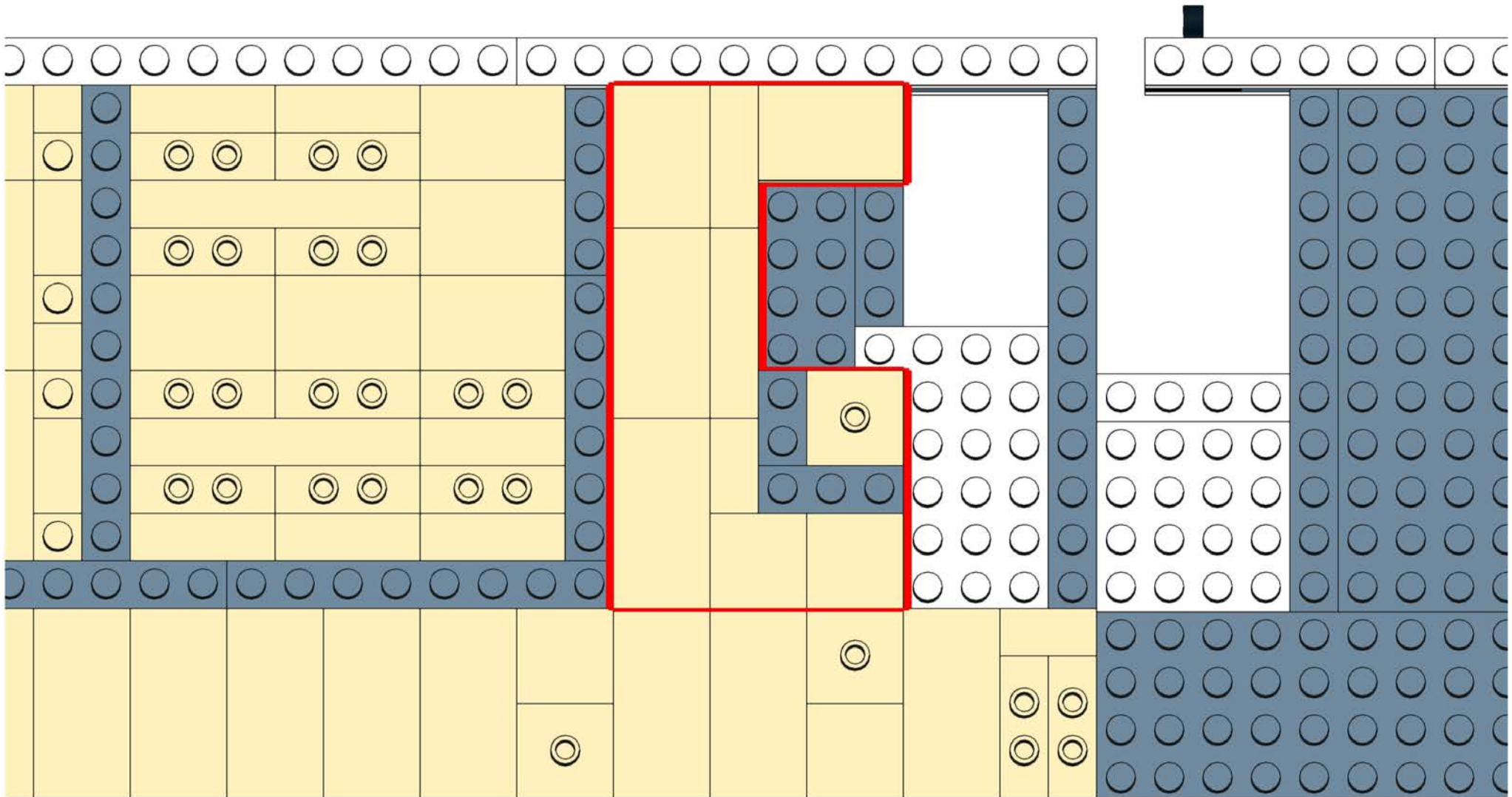
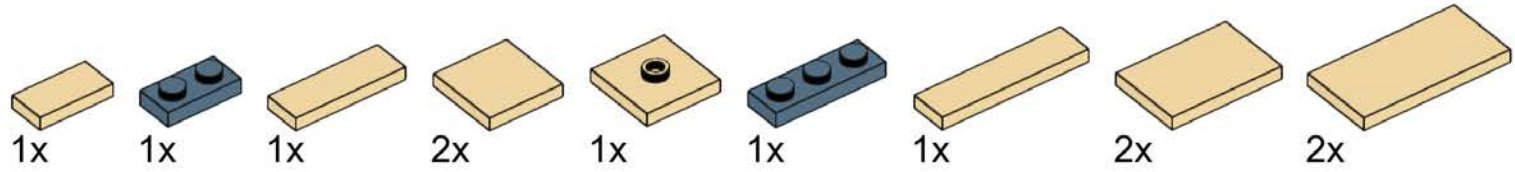

# 333

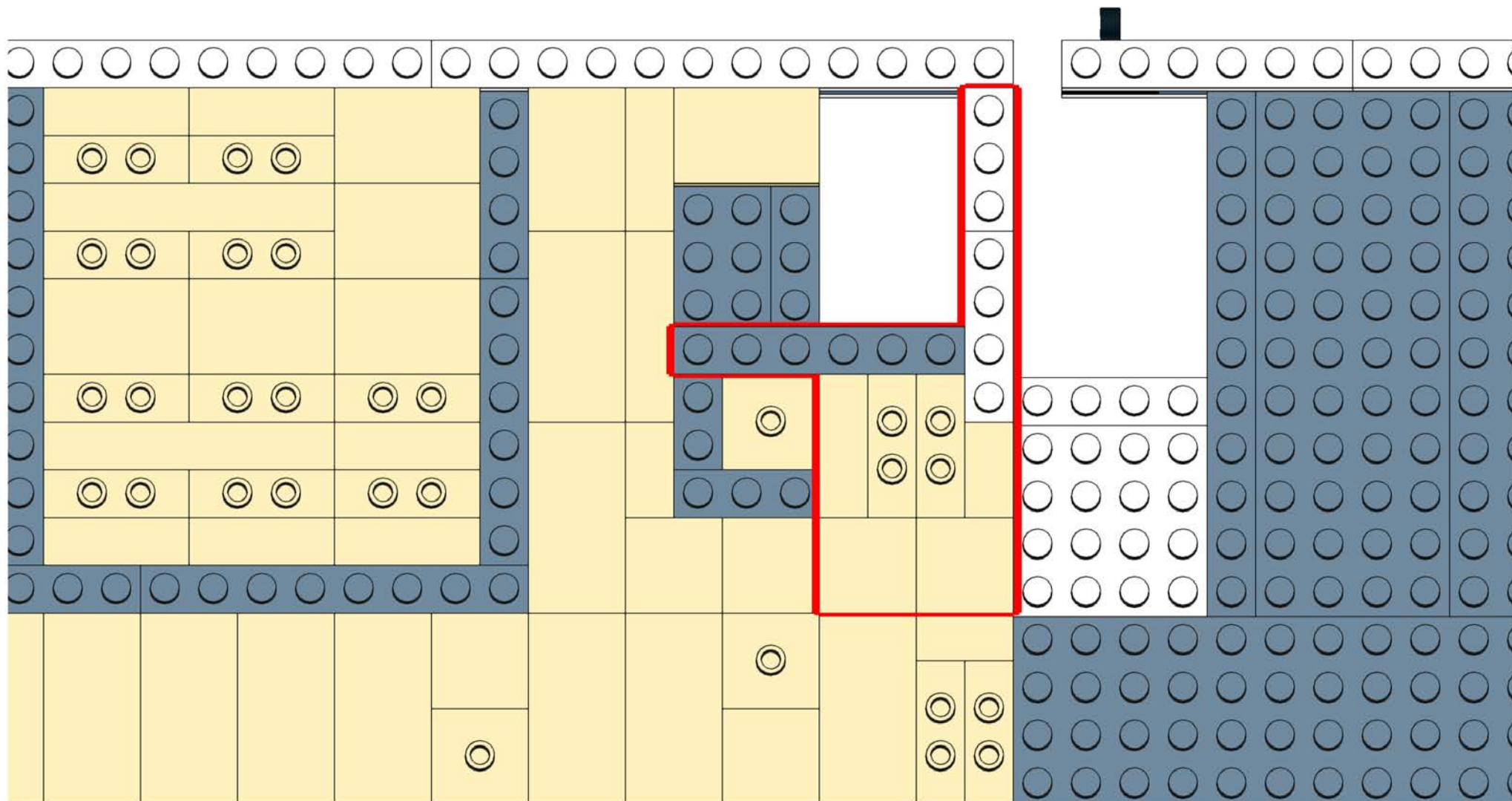
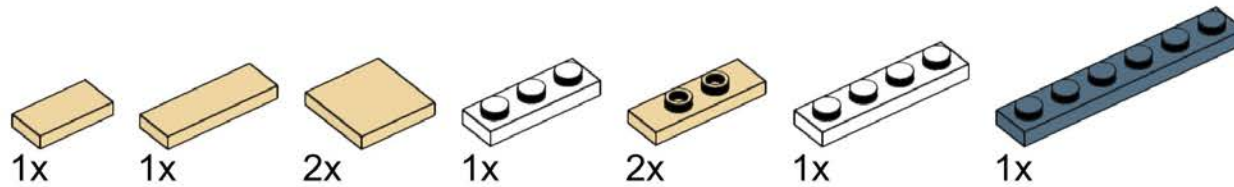

# 334

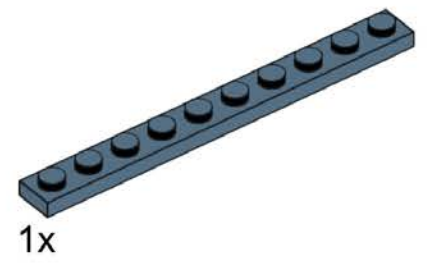
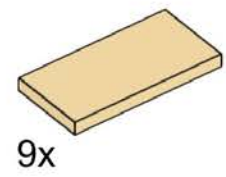
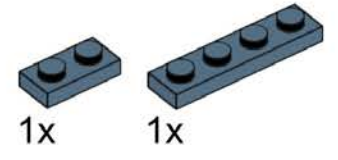
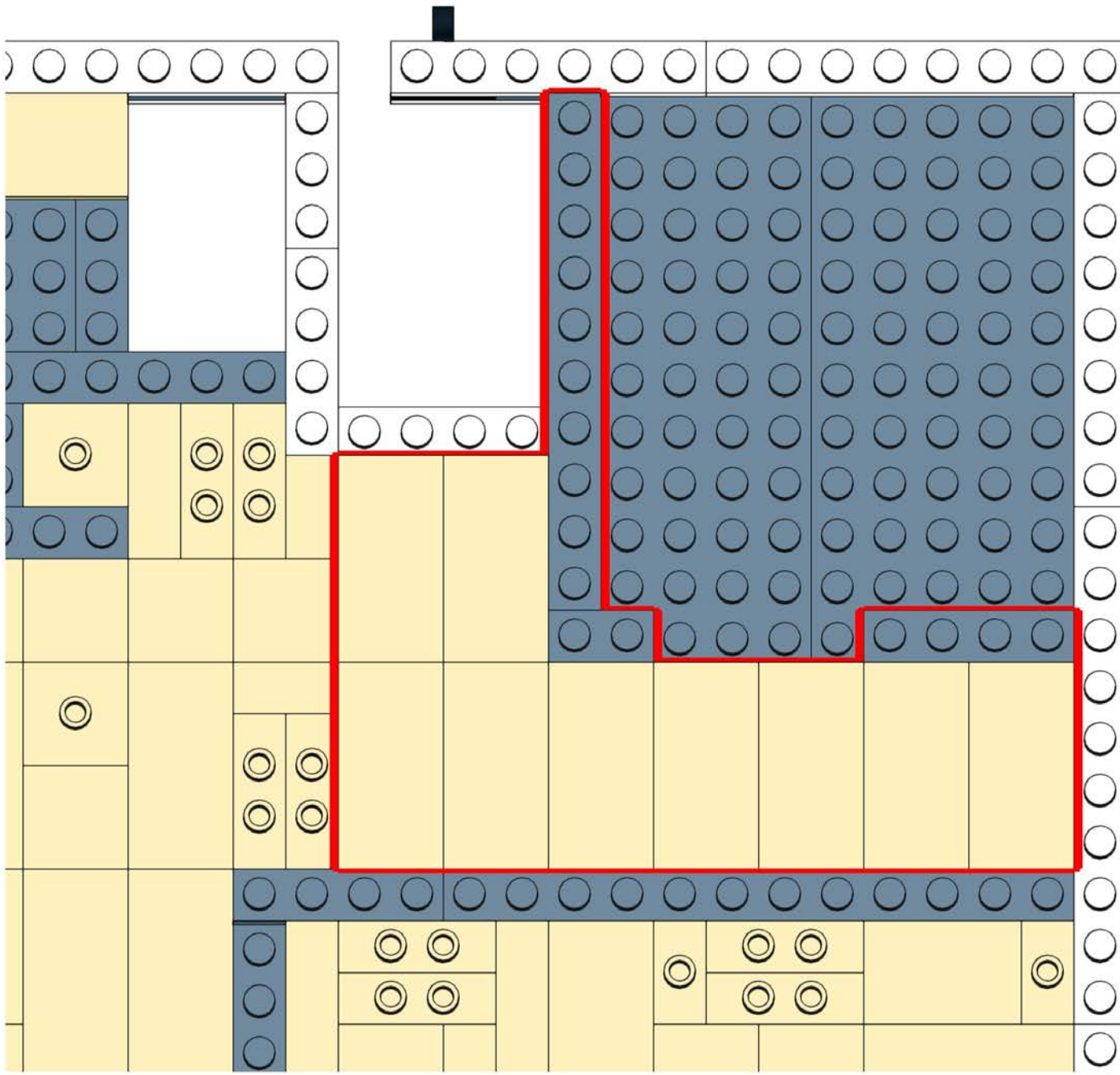

# 335

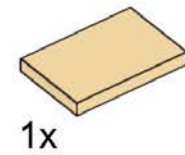
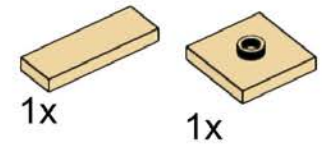
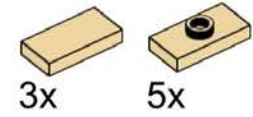
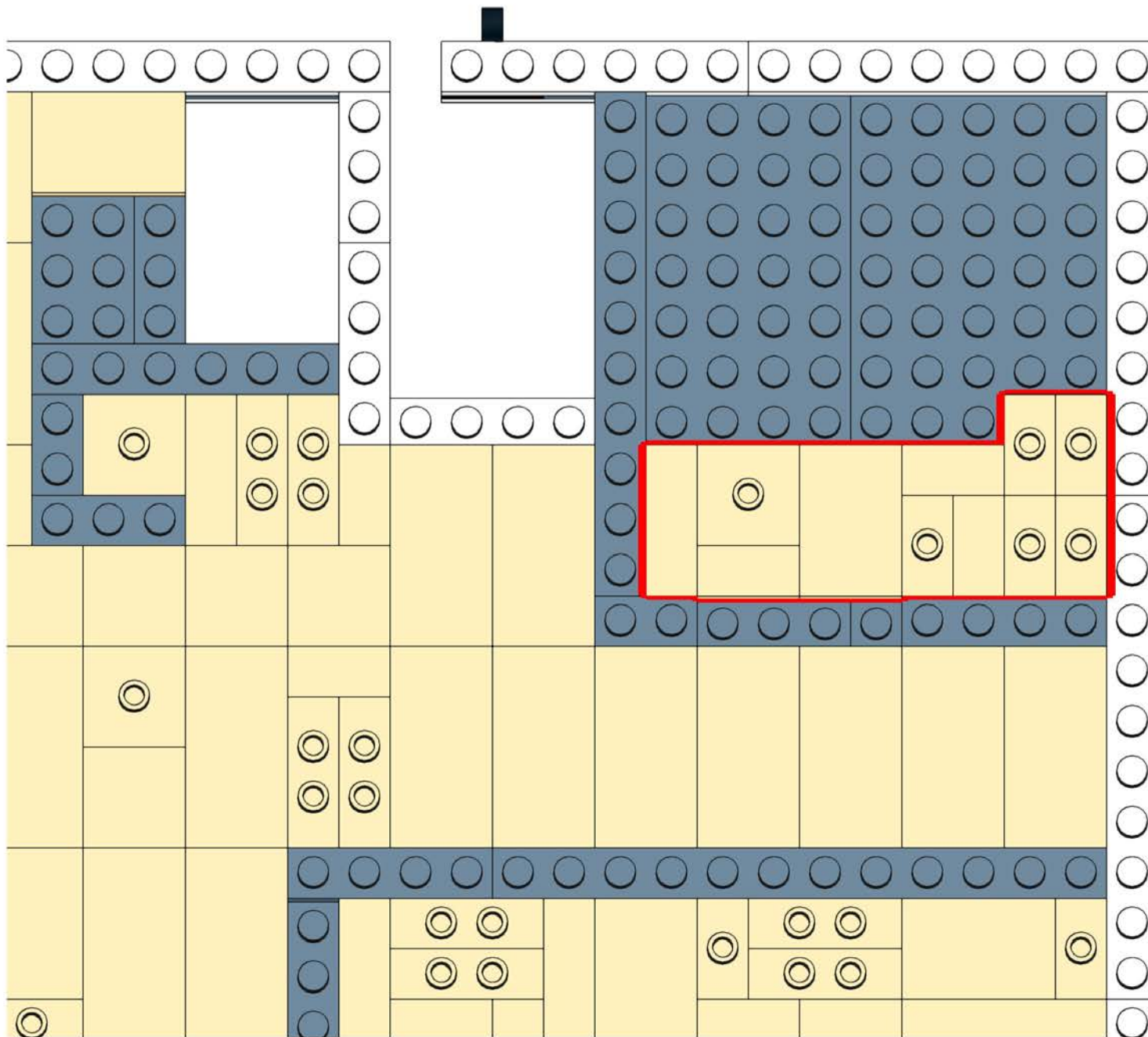

# 336

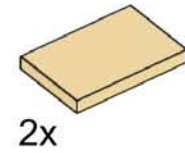
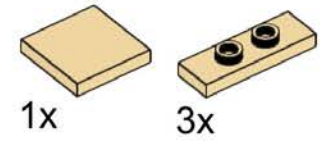
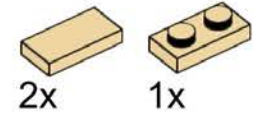
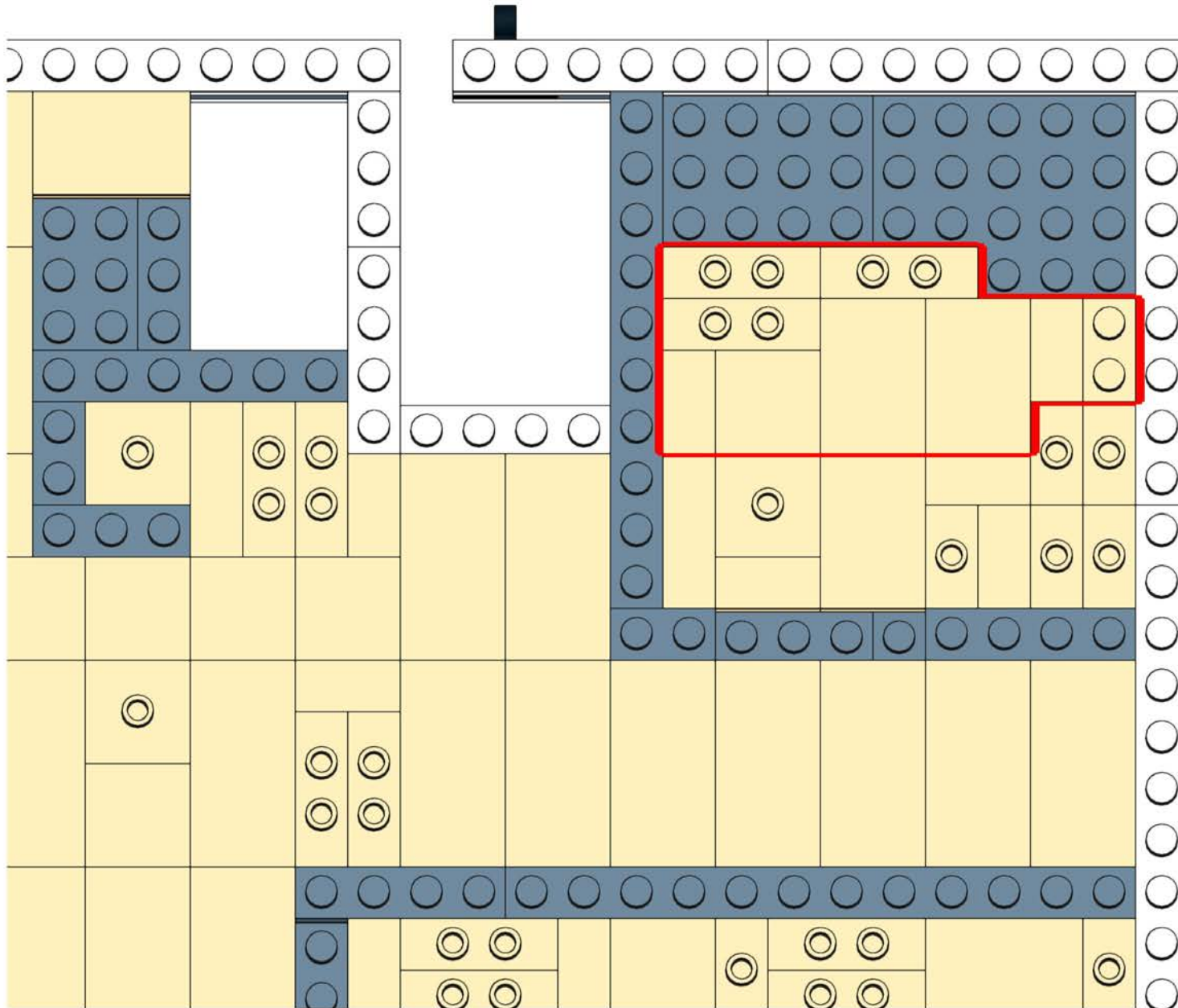

# 337

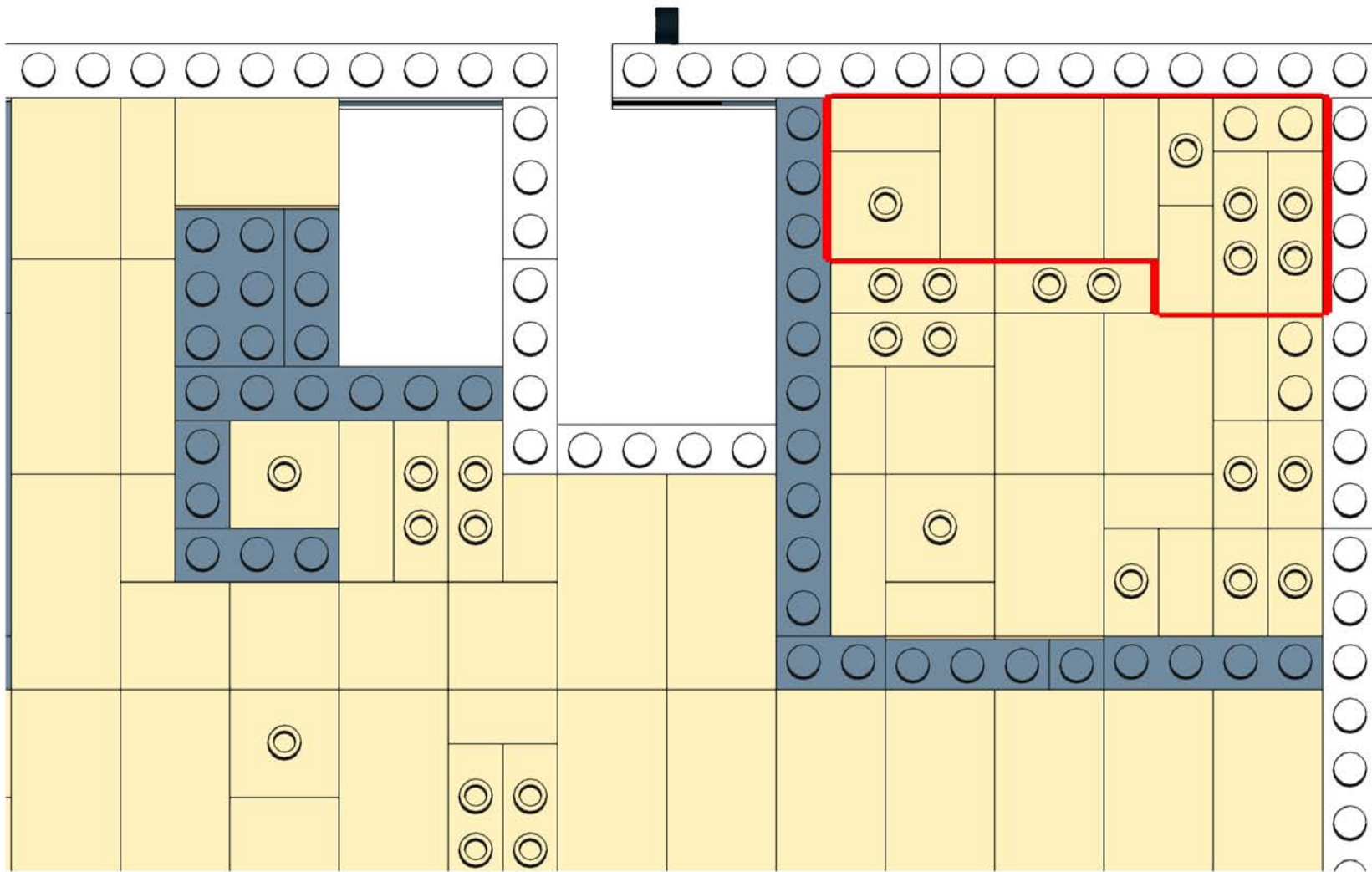
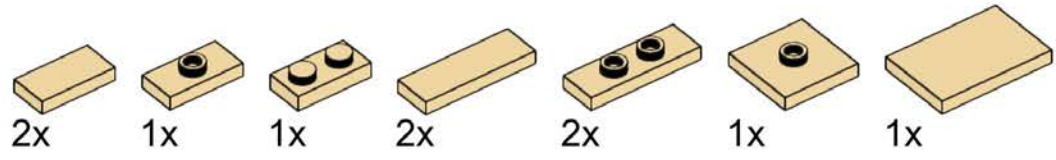

# 338

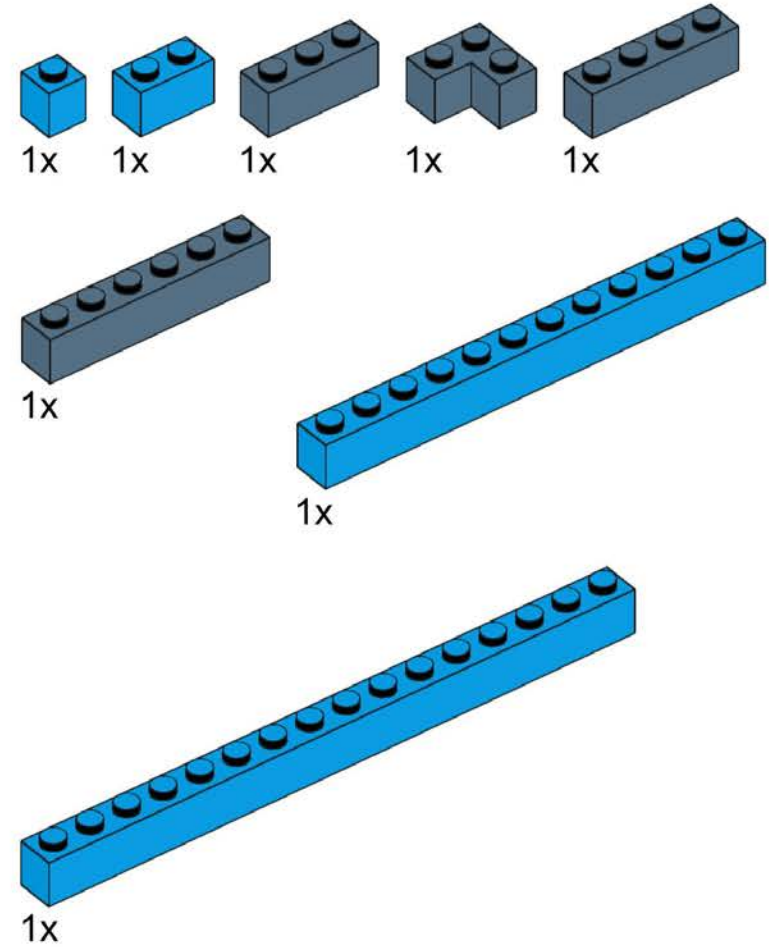
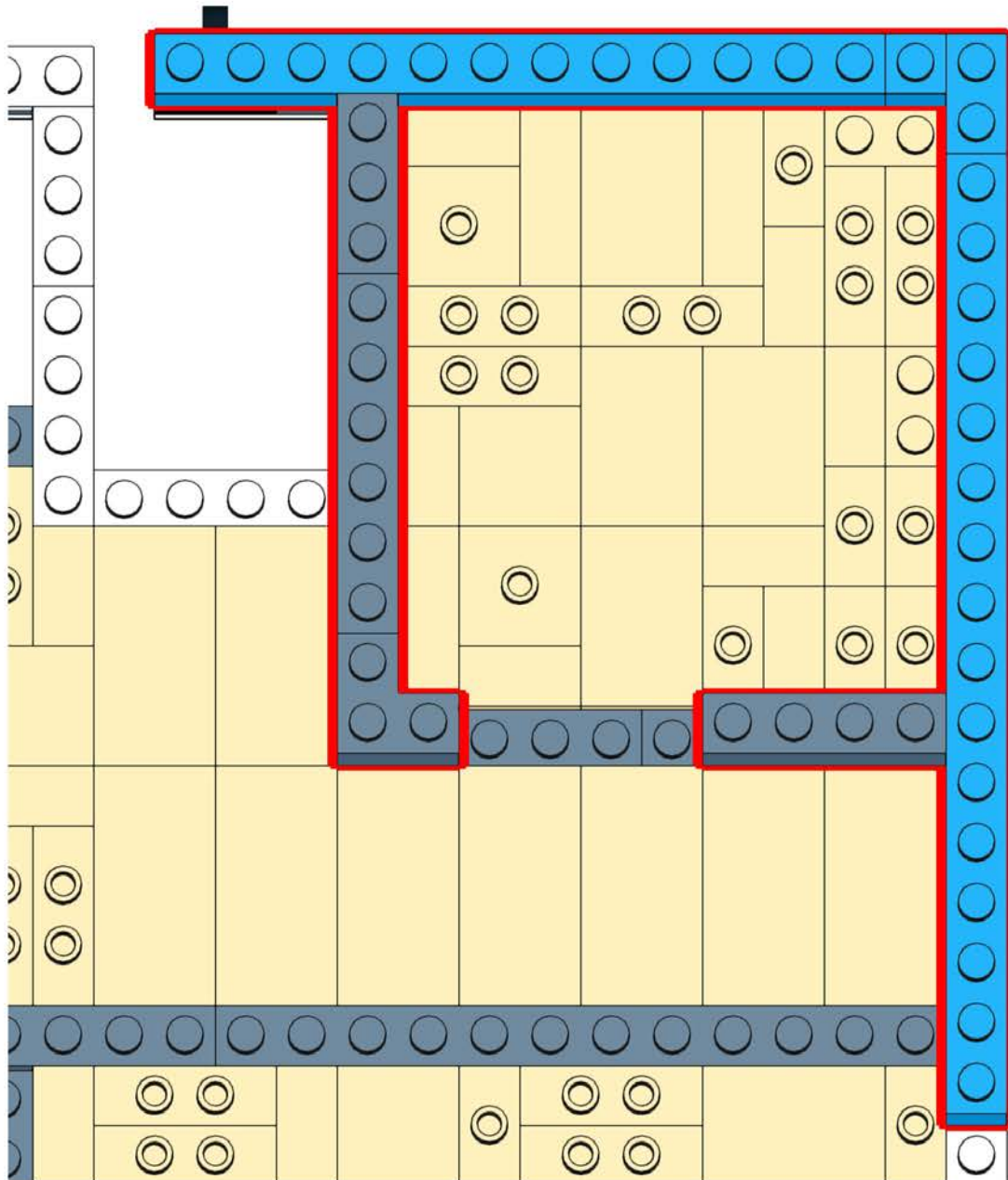



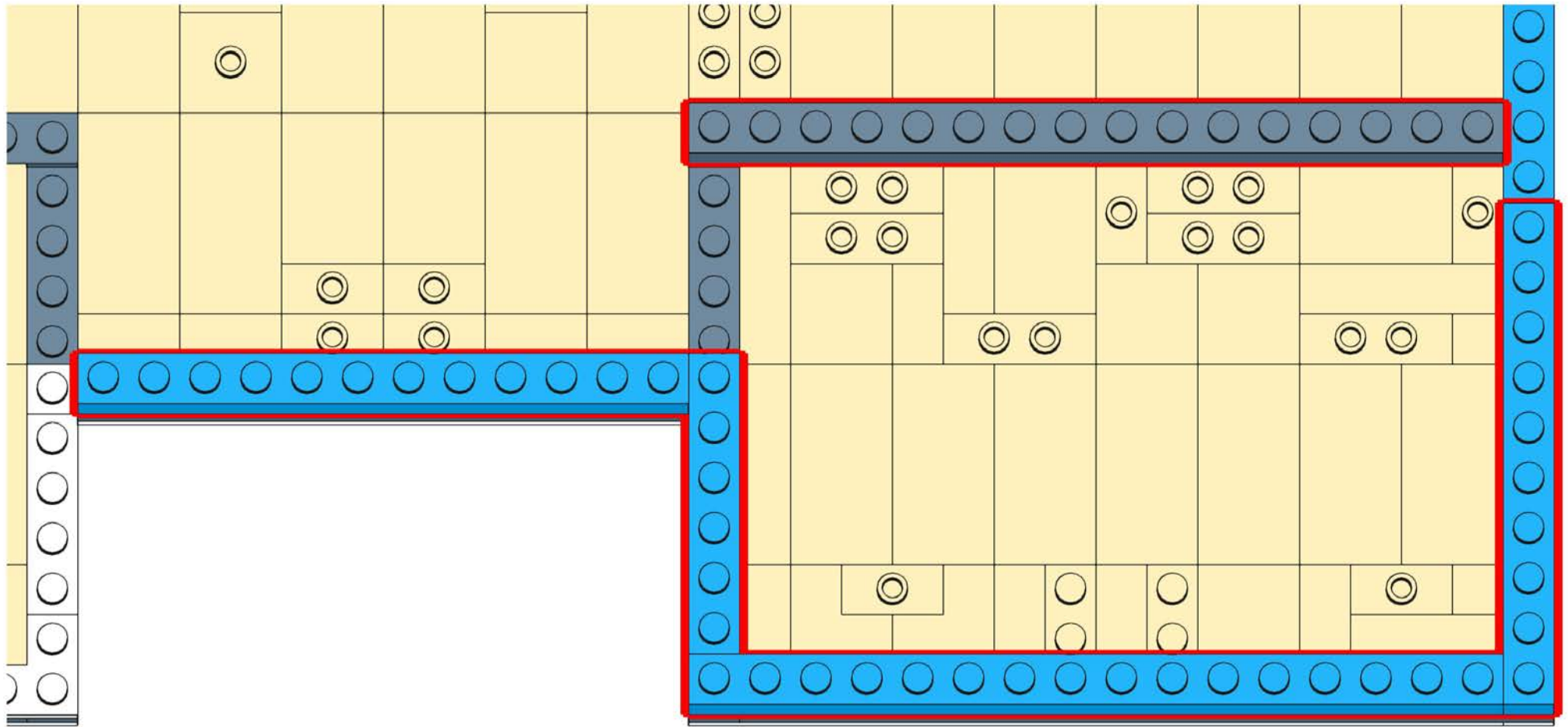

1x

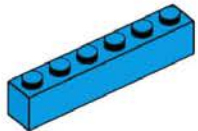

1x

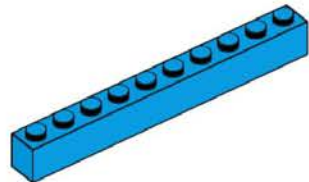

1x

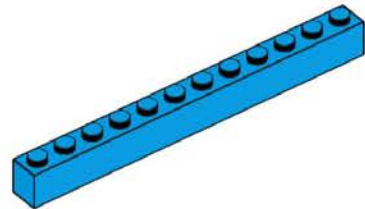

1x

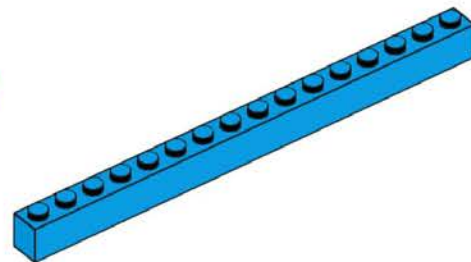

1x

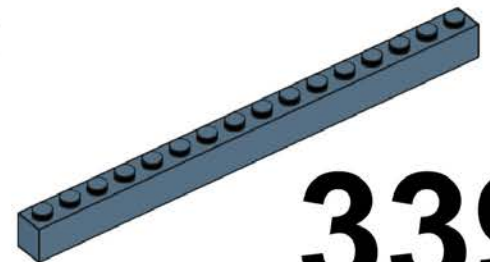

**339**

# 340

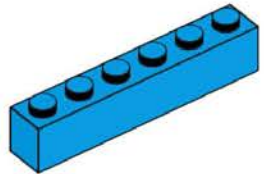

1x

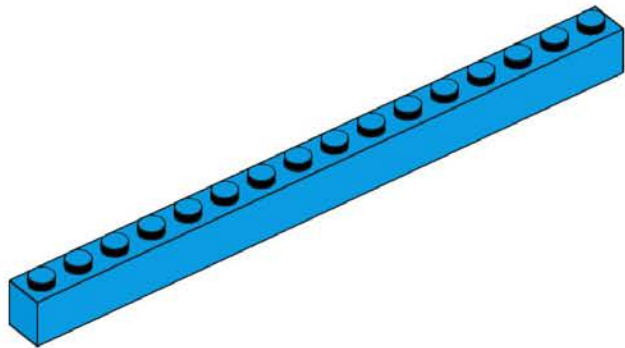

2x

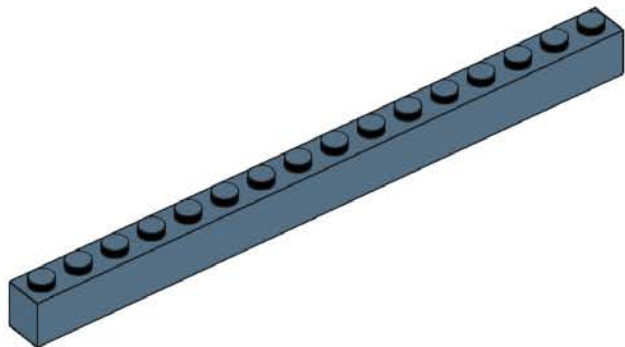

1x

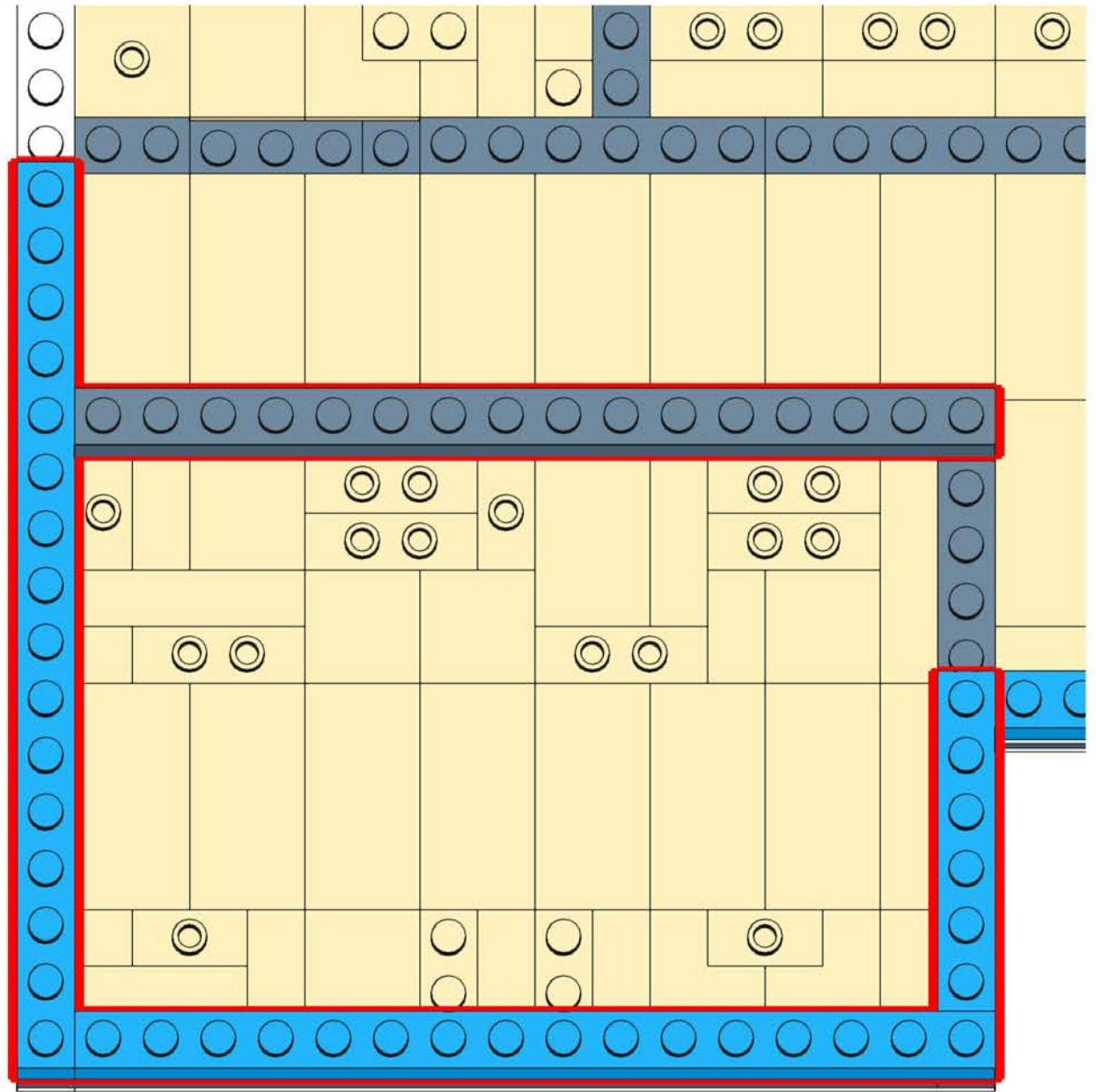

# 341

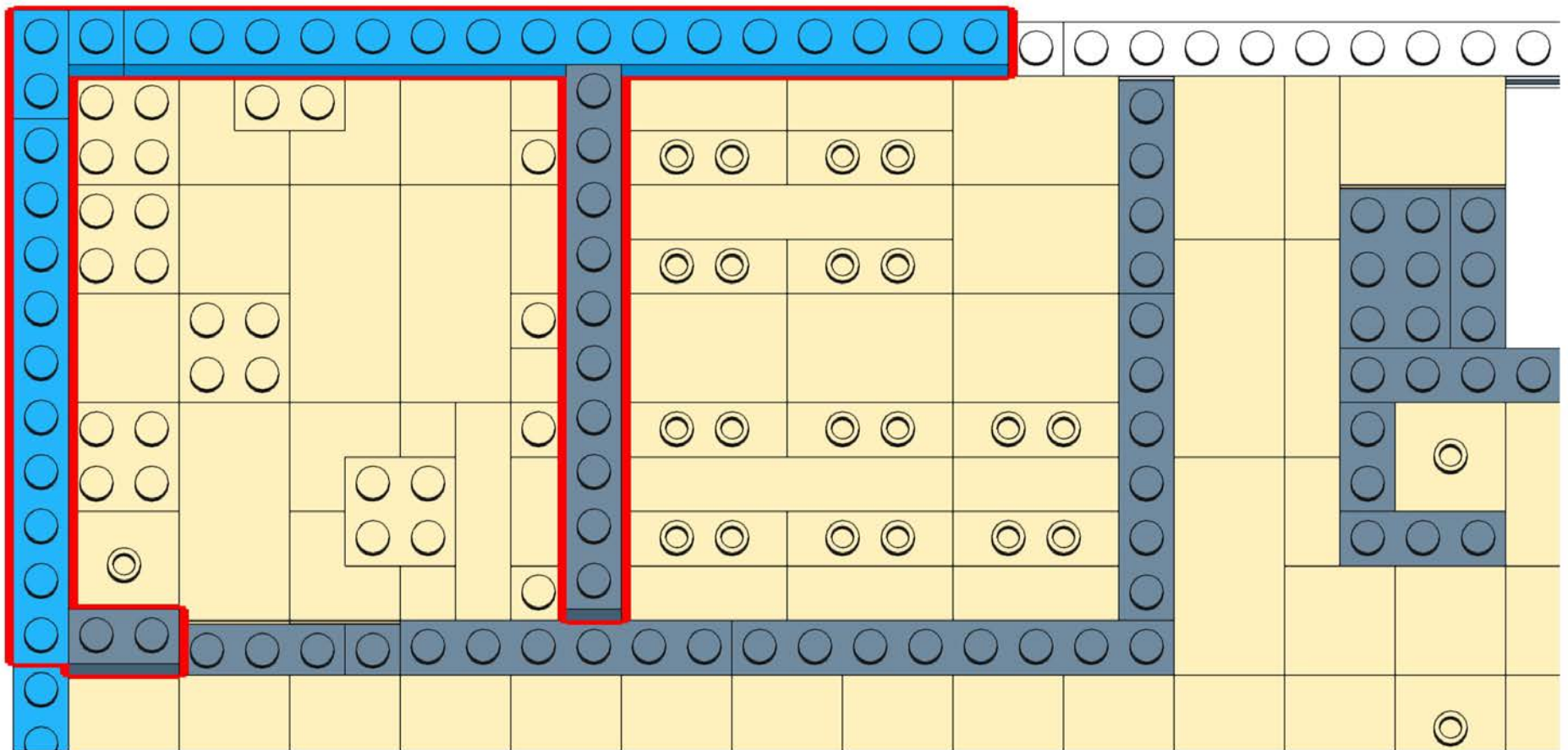
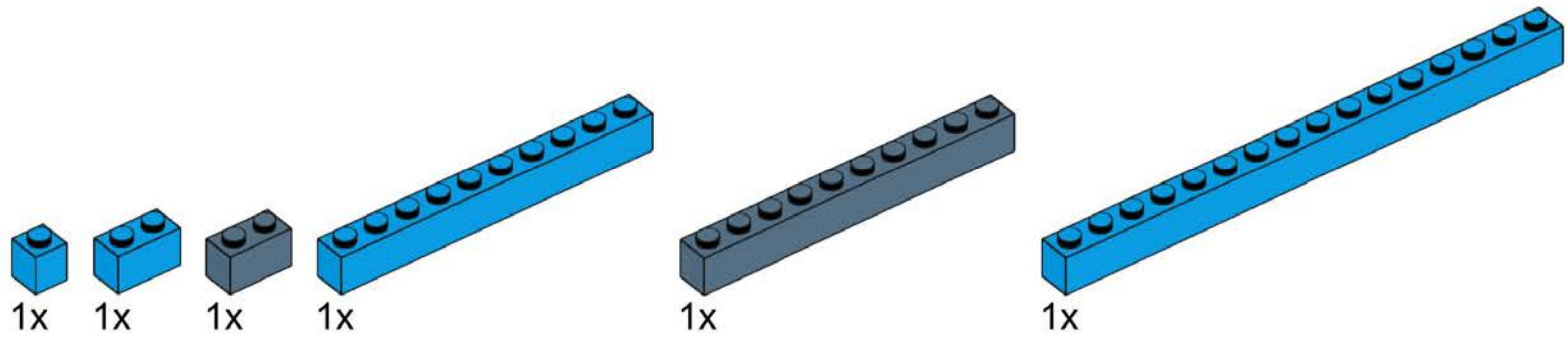



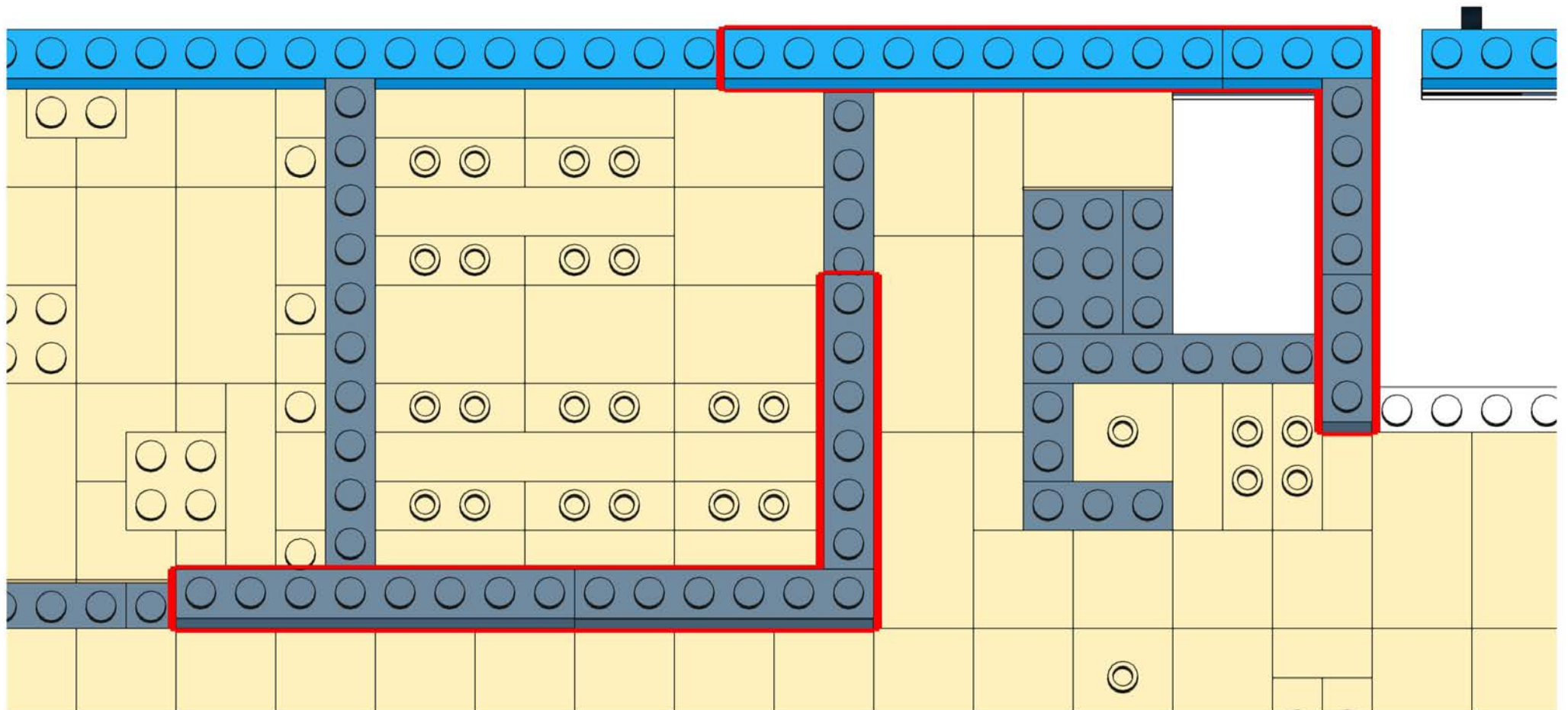
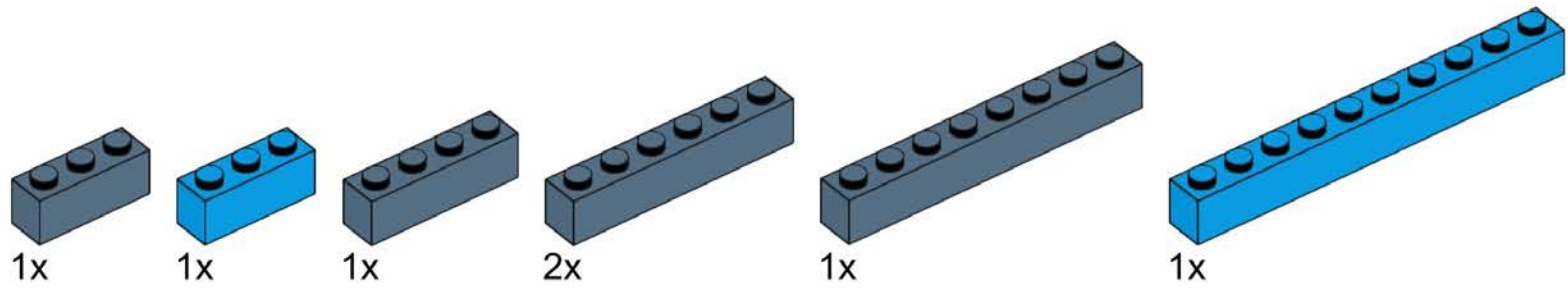

# 342

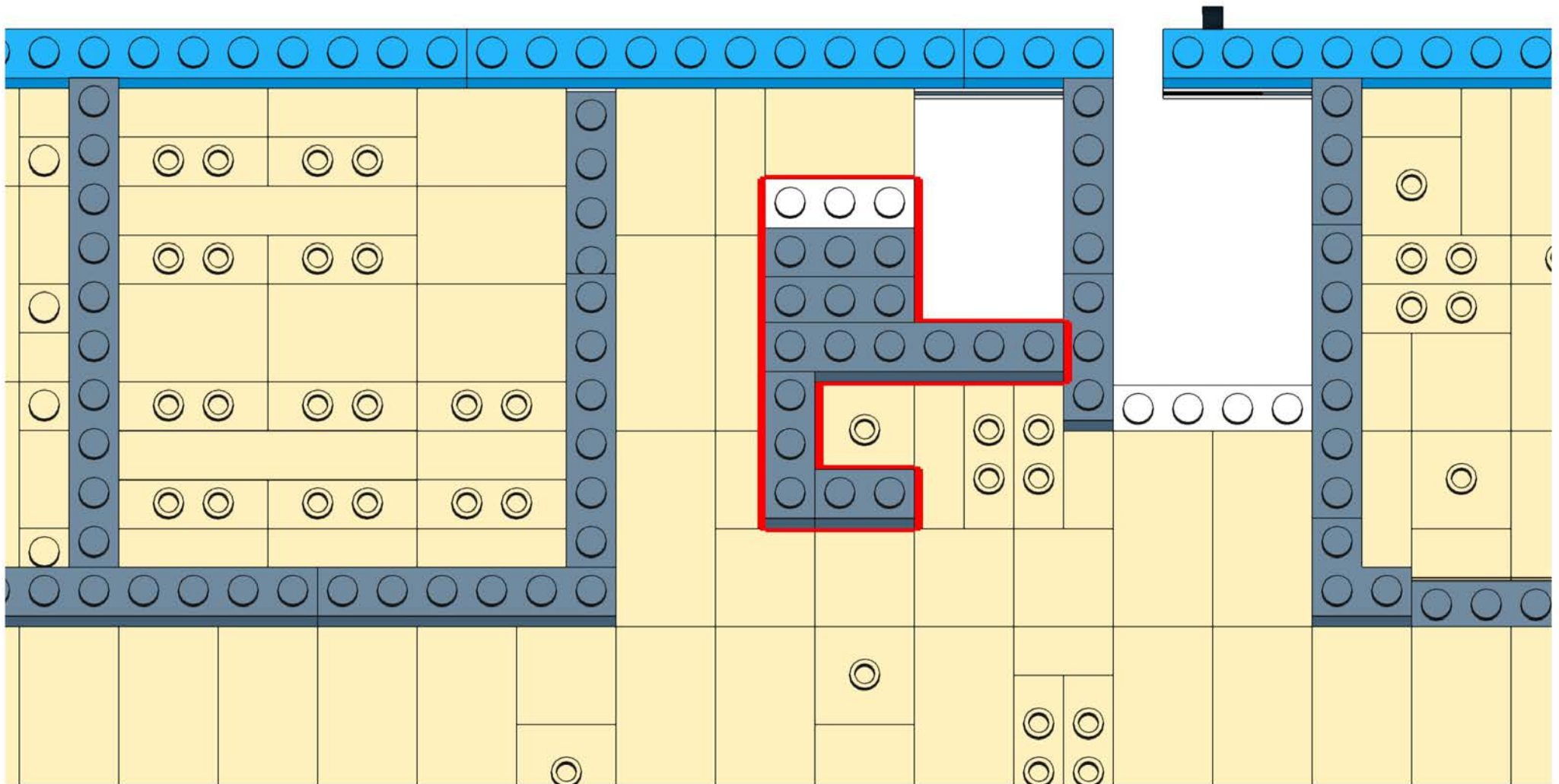
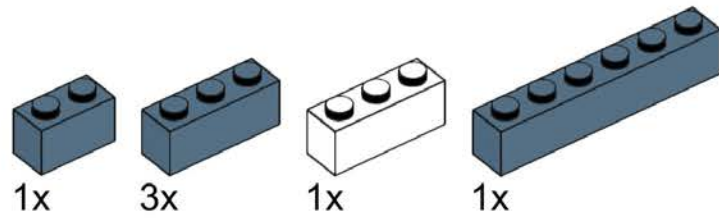

# 343



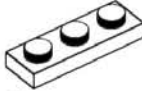

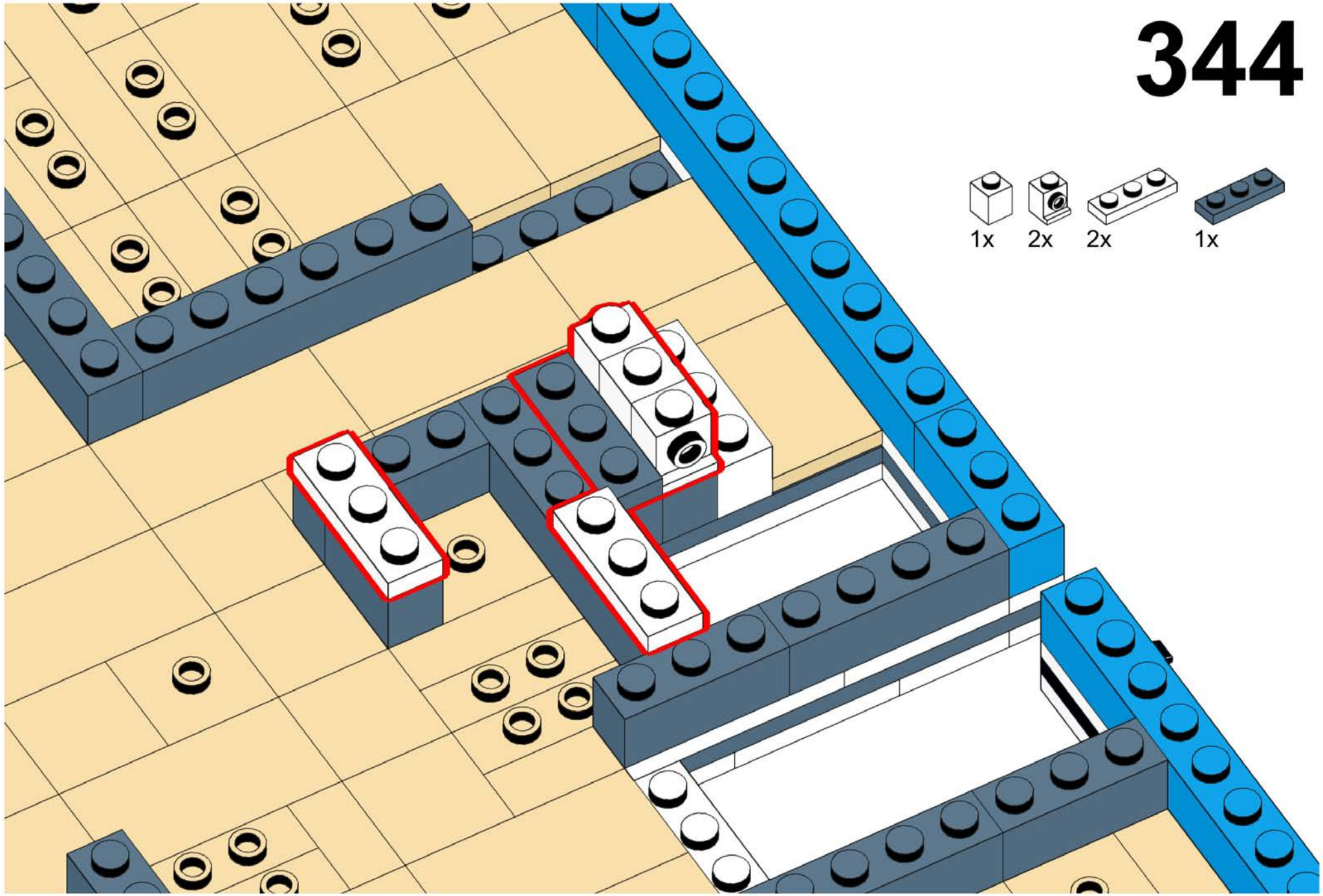

# 344

- 1x 
- 2x 
- 2x 
- 1x 

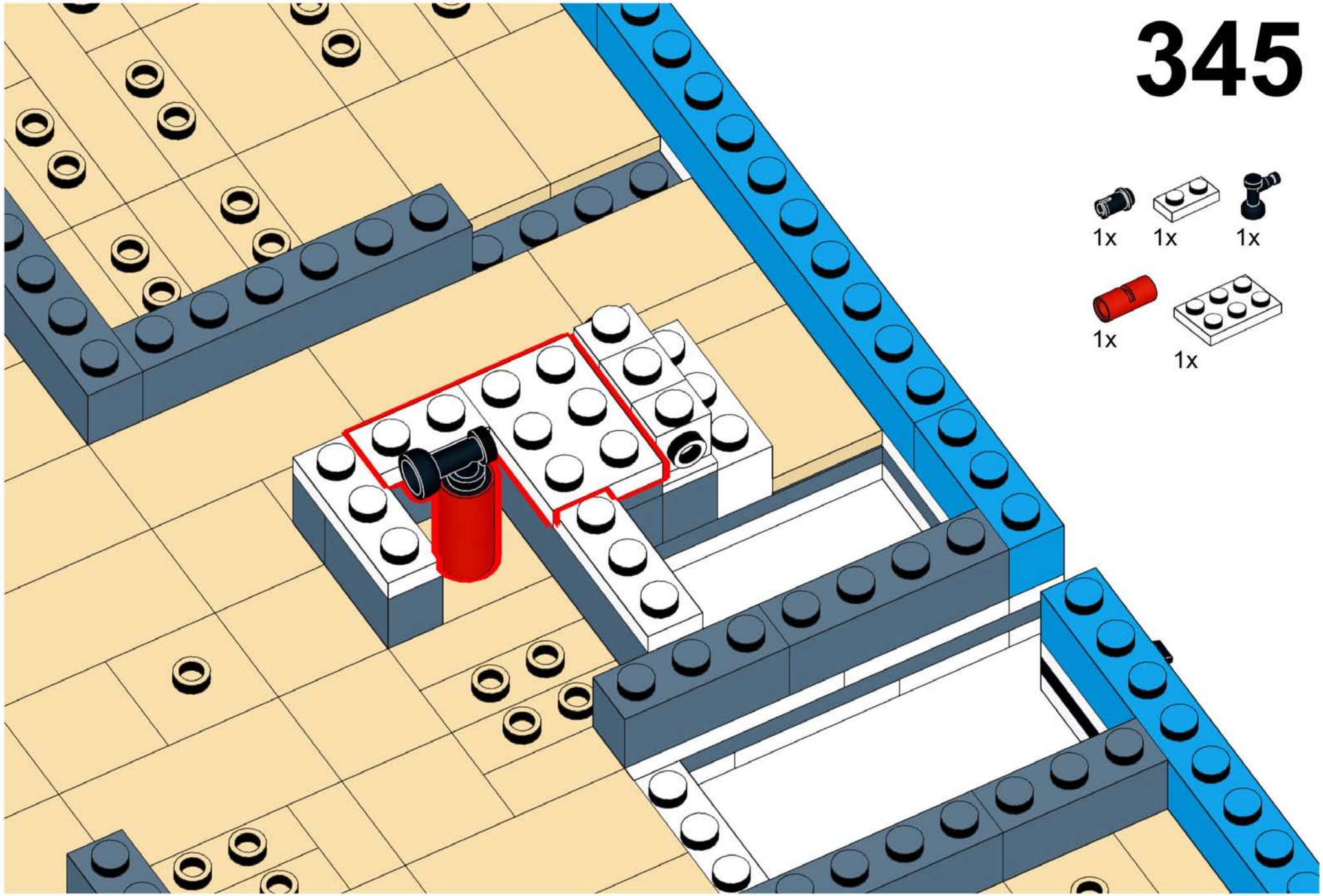

# 345

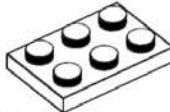

- 1x 
- 1x 
- 1x 
- 1x 
- 1x 

# 346

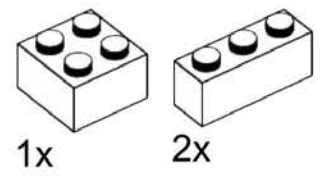
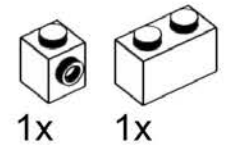
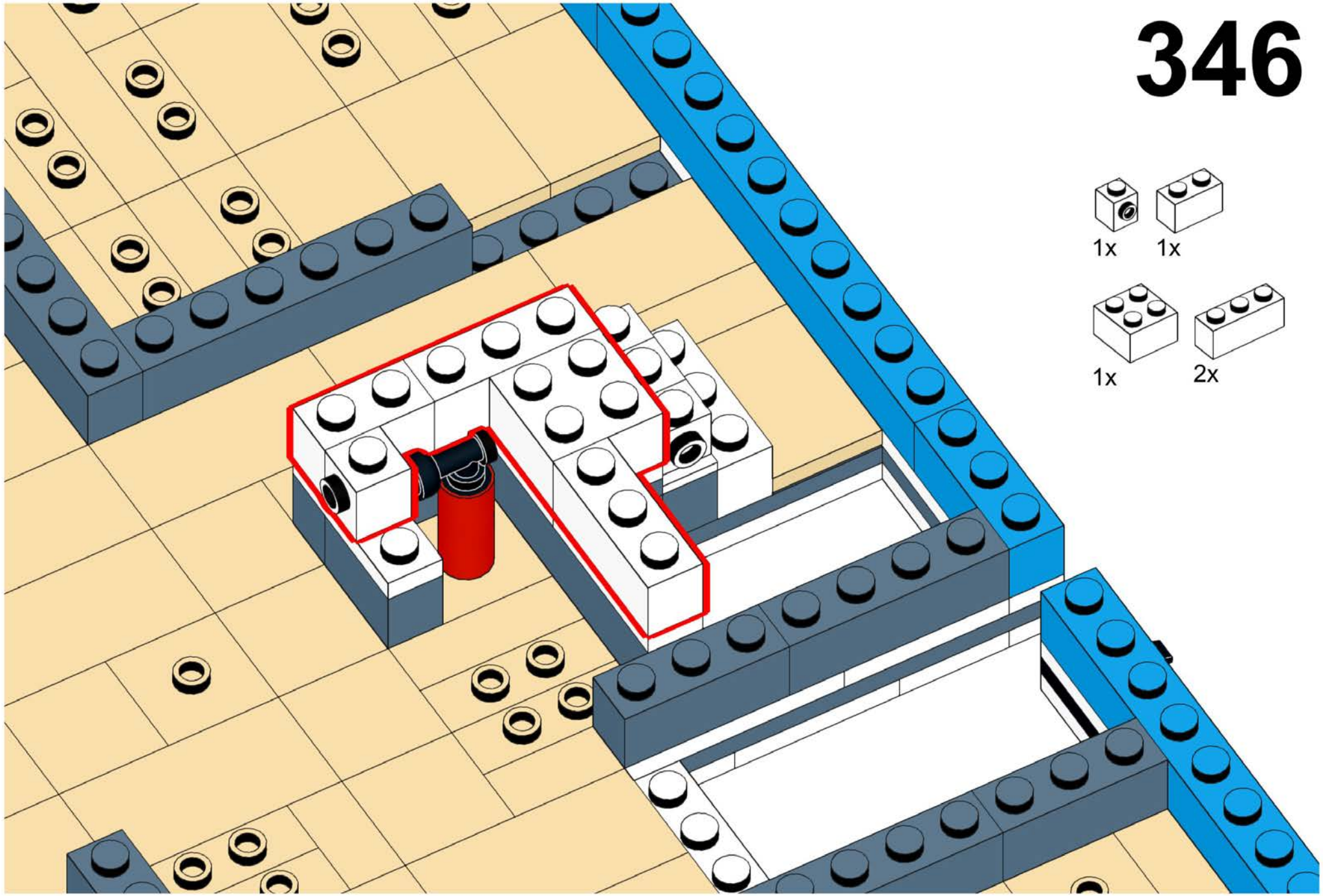



# 347

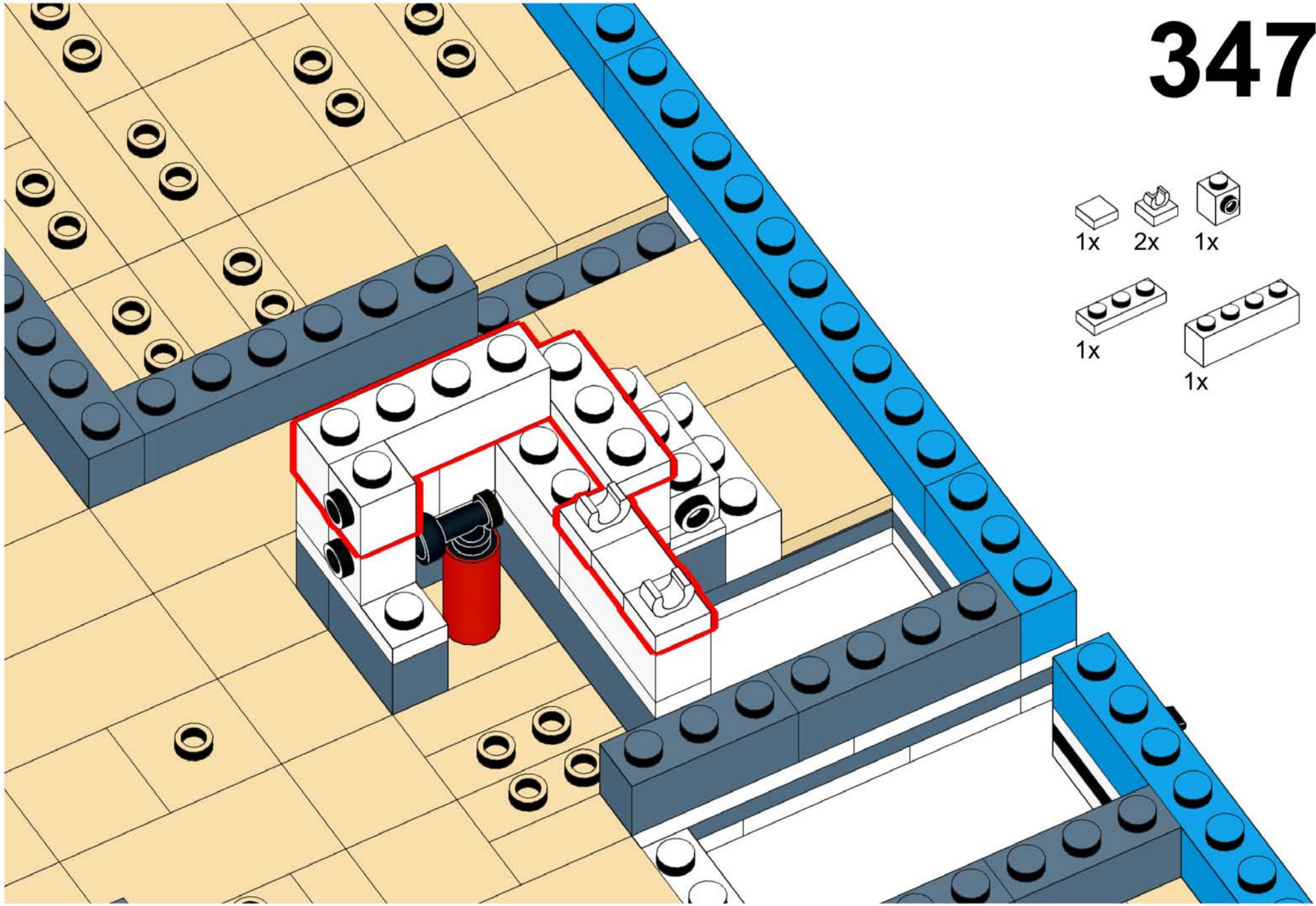



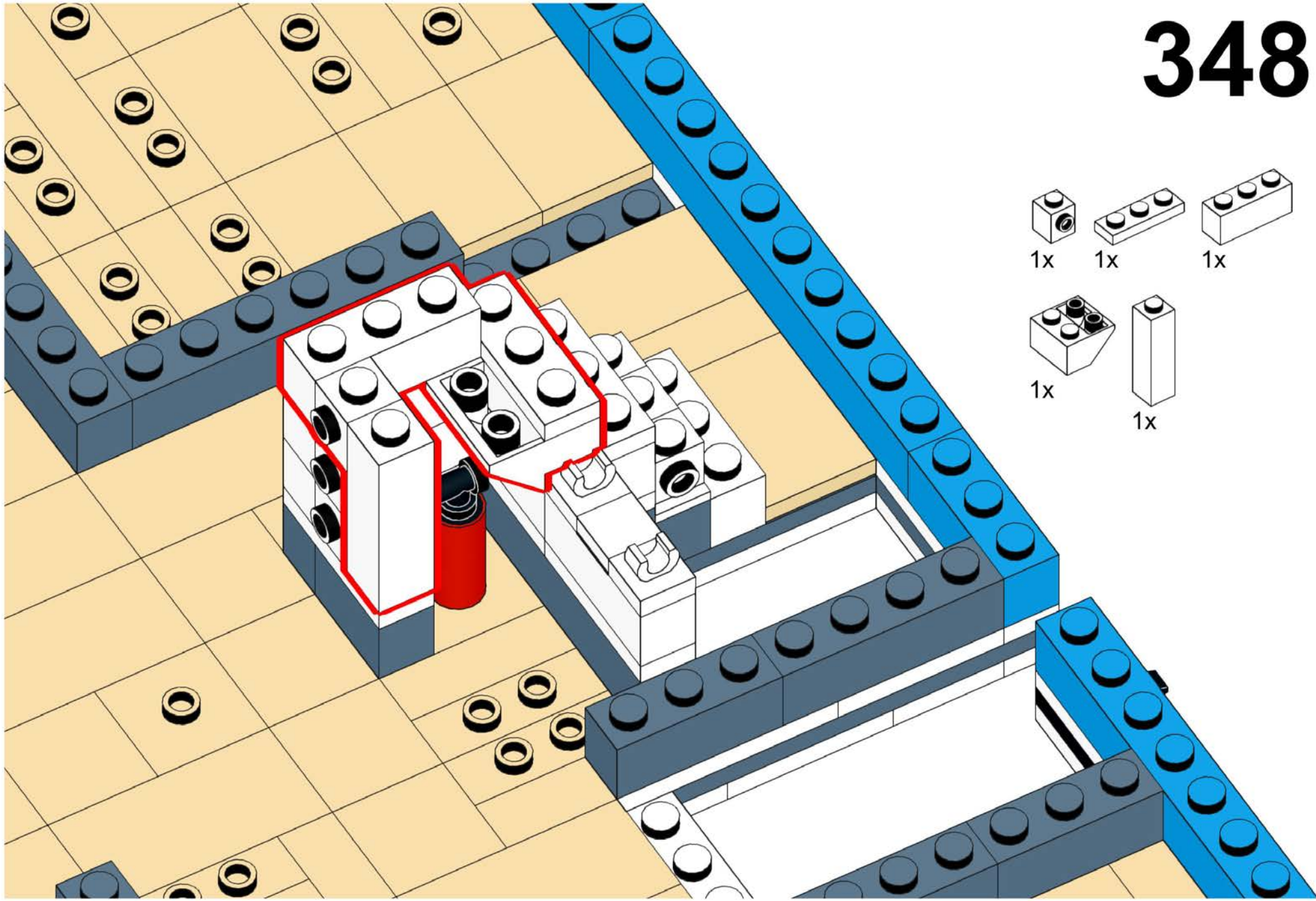

- 1x [white 1x1 brick]
- 2x [white 1x1 Technic pin]
- 1x [white 1x1 Technic bush]
- 1x [white 1x3 Technic brick]
- 1x [white 1x4 Technic brick]

# 348

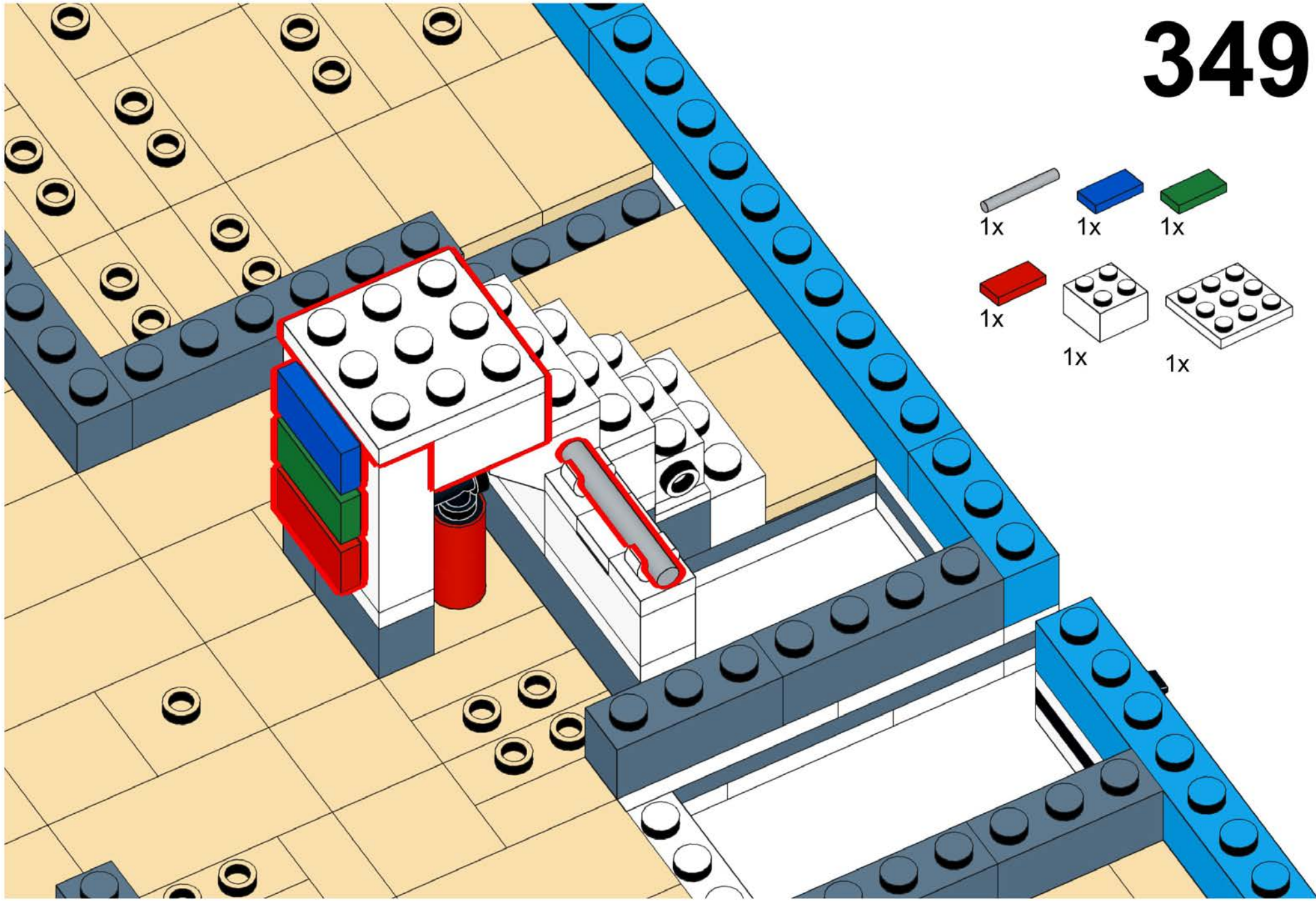



# 349

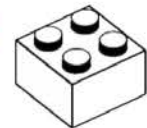
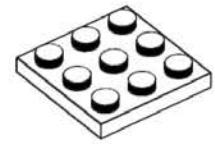

- 1x 
- 1x 
- 1x 
- 1x 
- 1x 
- 1x 

# 350

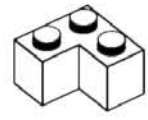
- 1x 
- 2x 
- 1x 

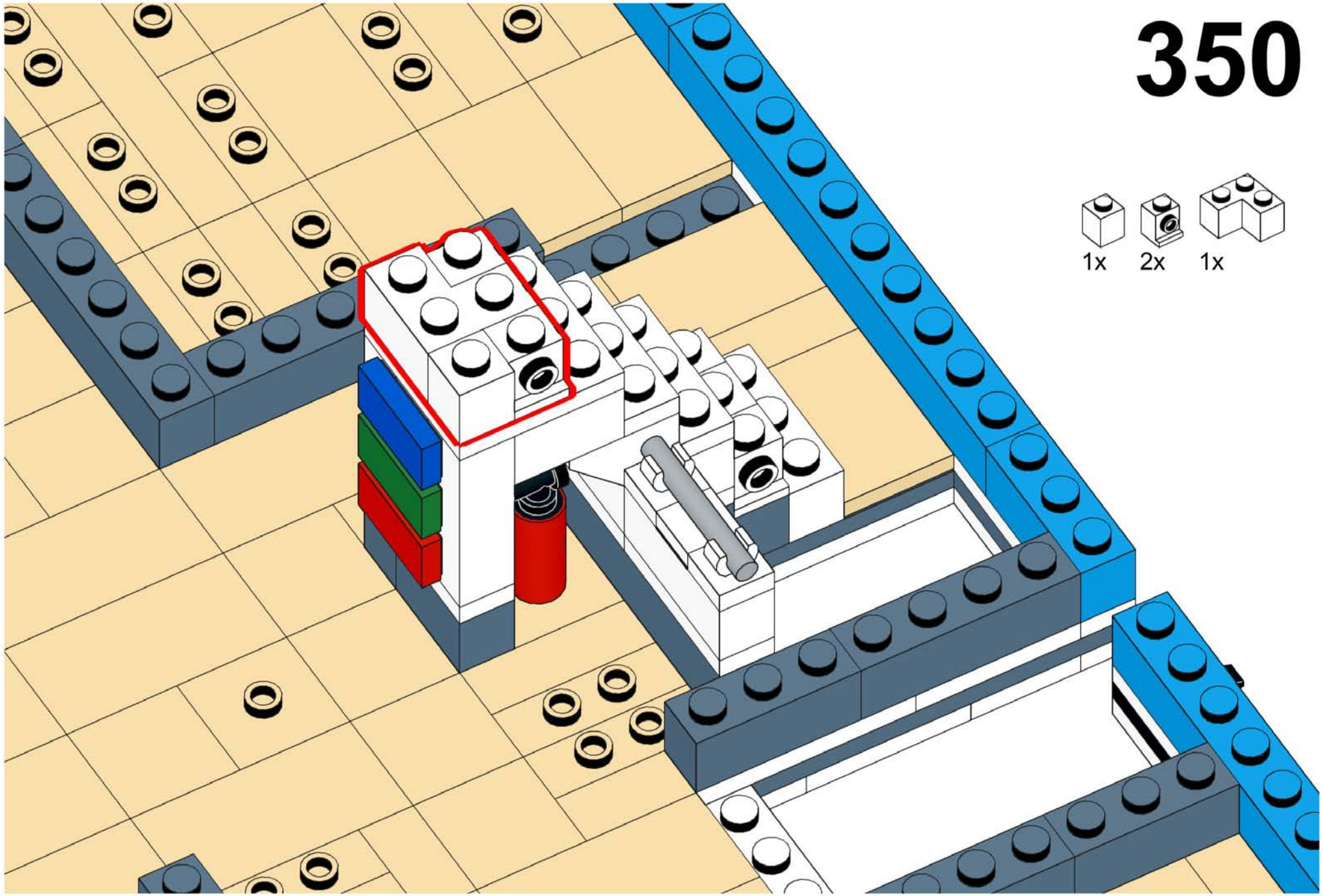

# 351

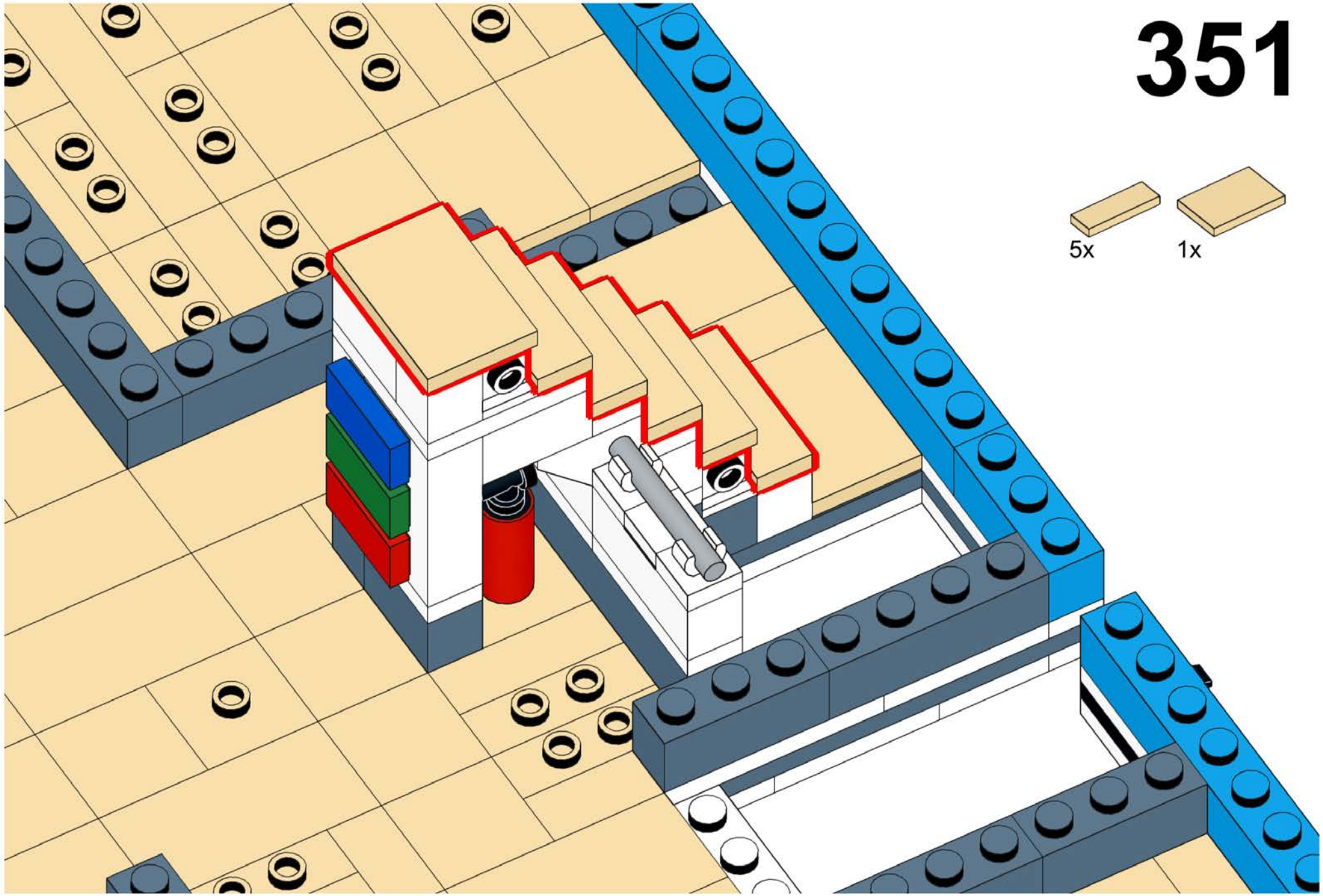

# 352

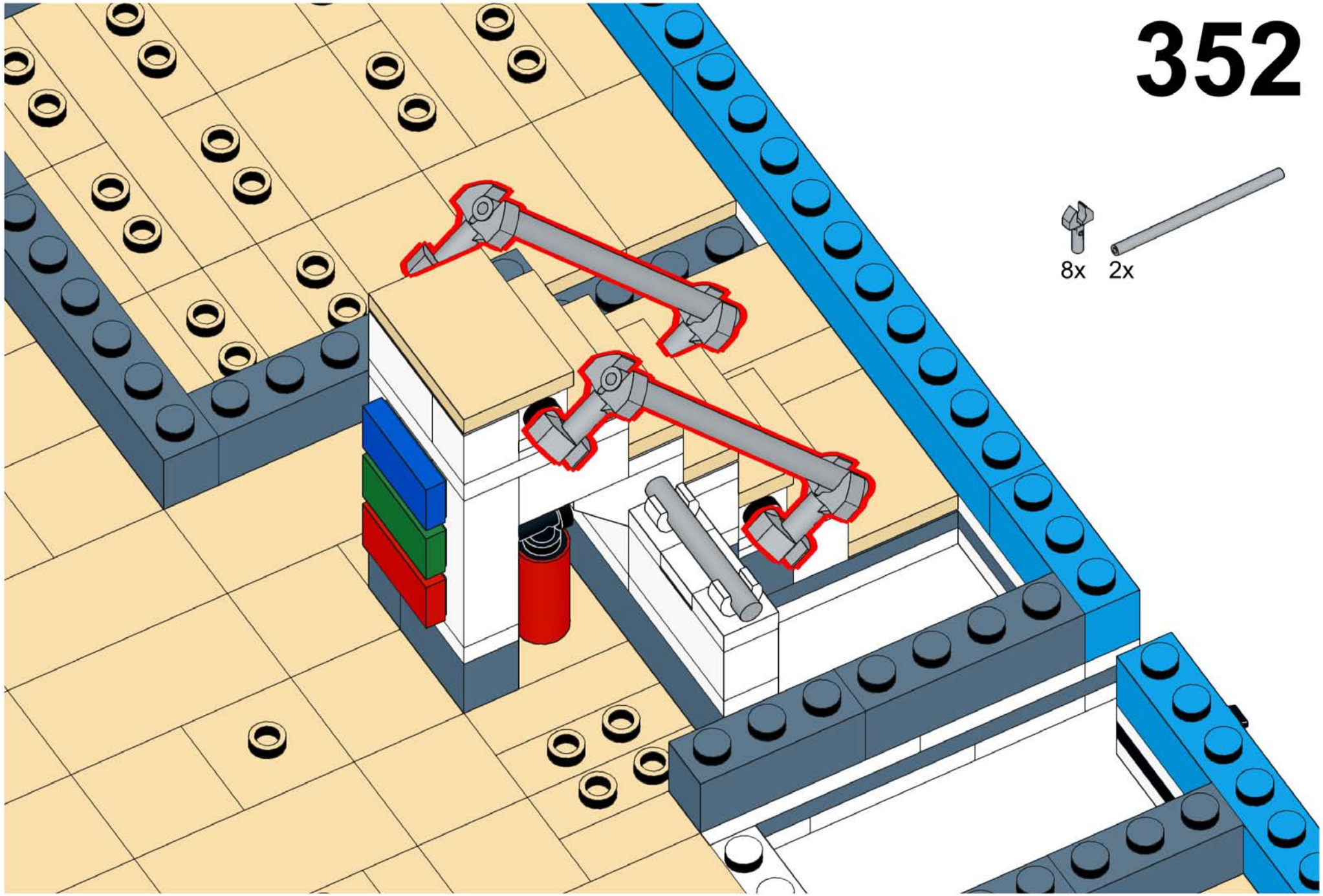

# 353

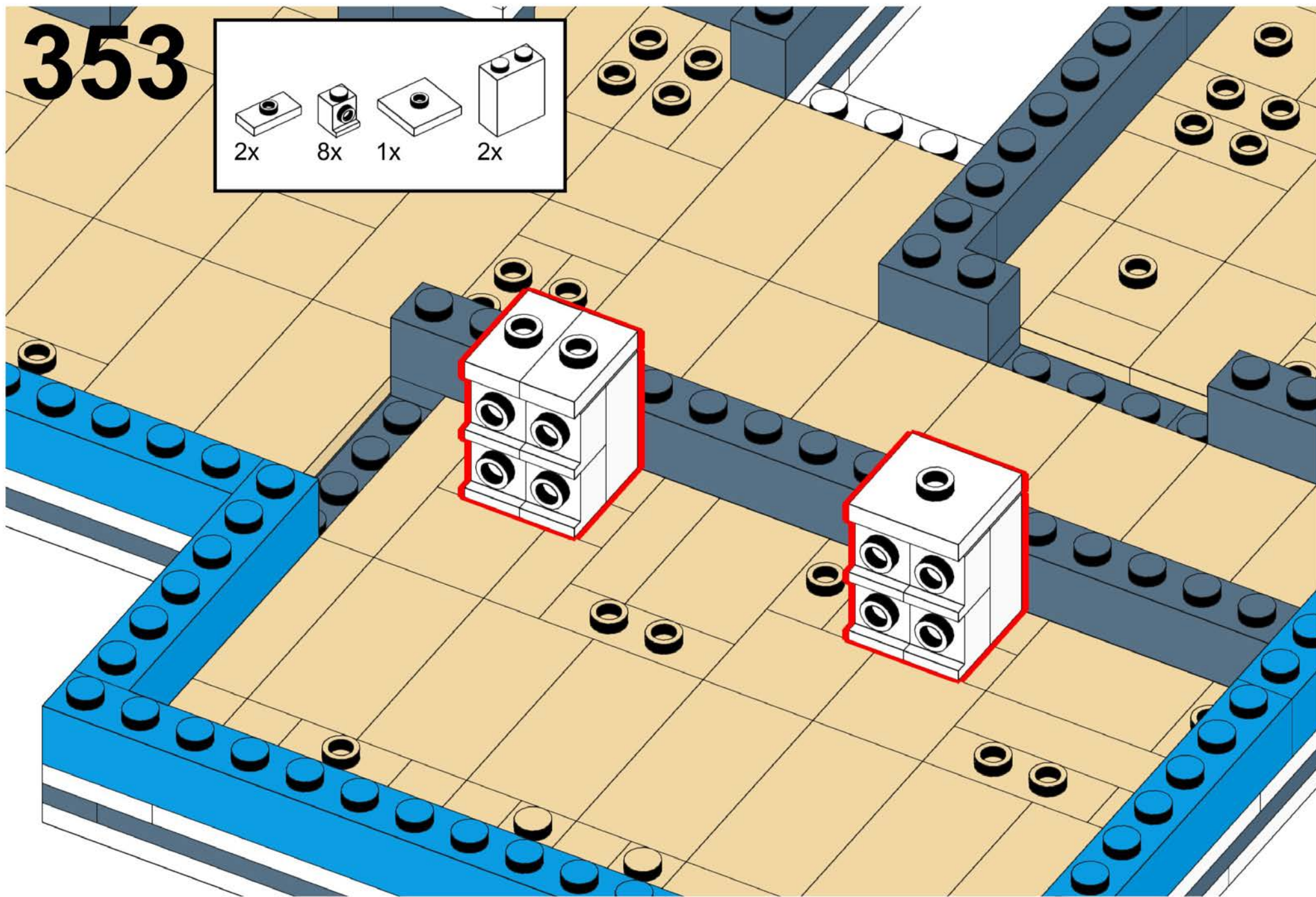
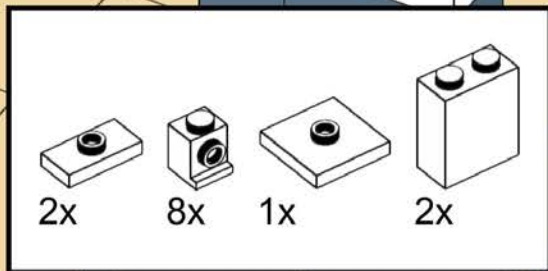

# 354

Flesh = f

mdf



1x



1x



4x



1x



1x

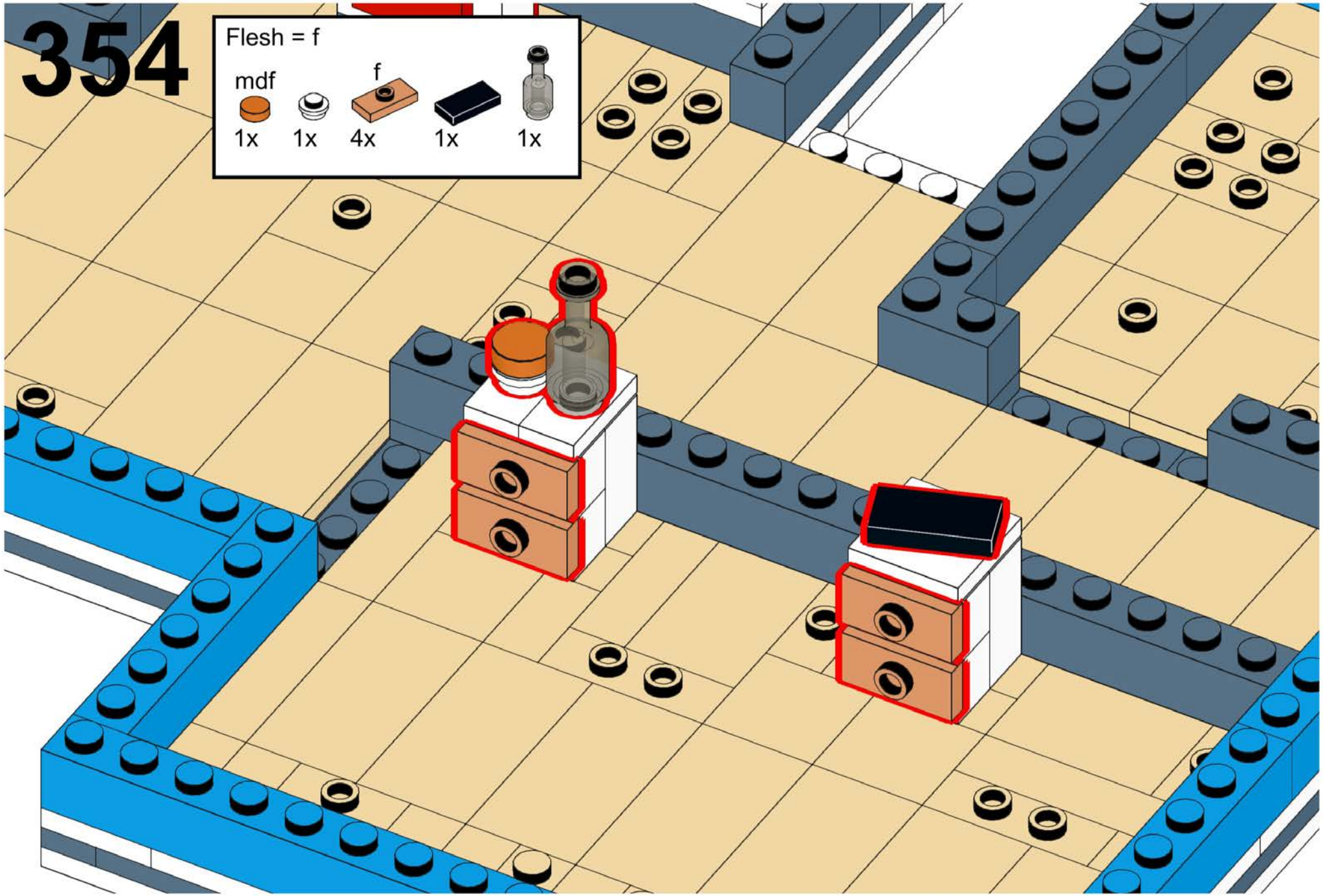



# 355

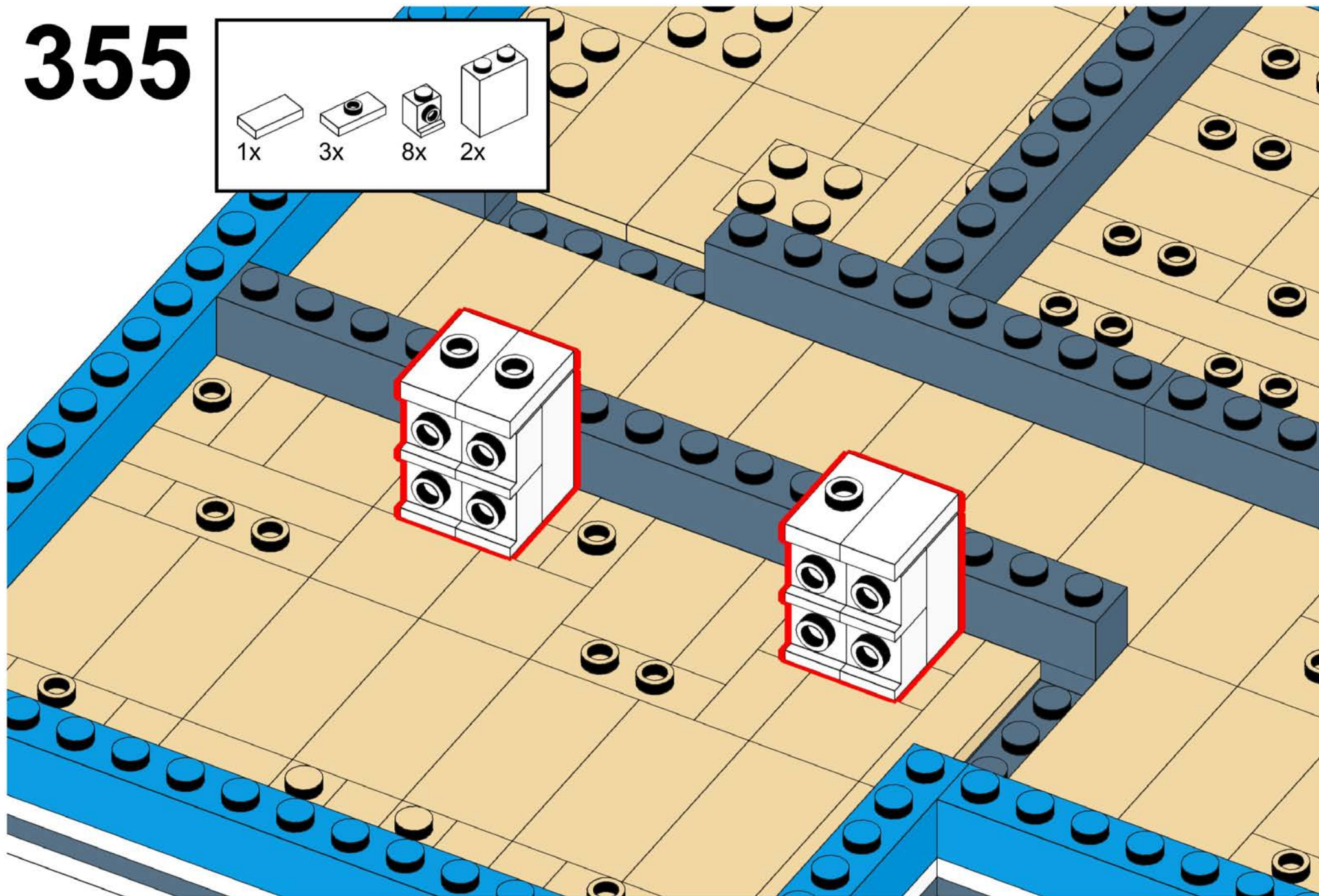
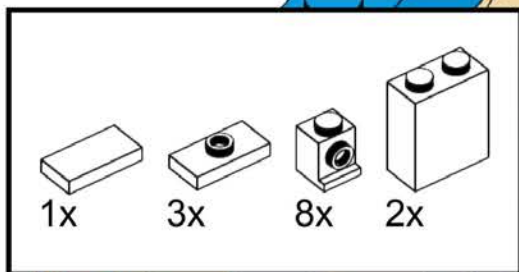

# 356

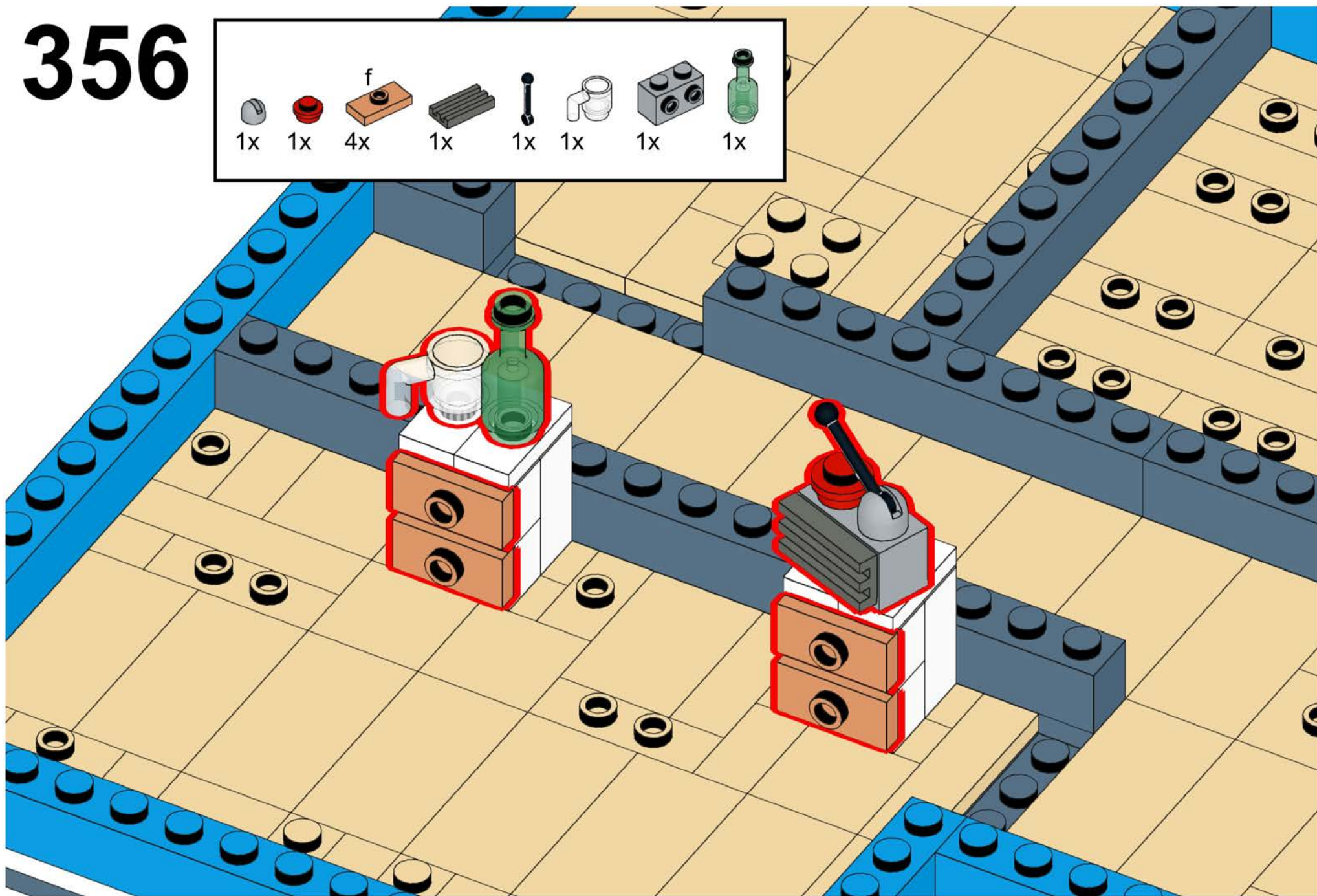
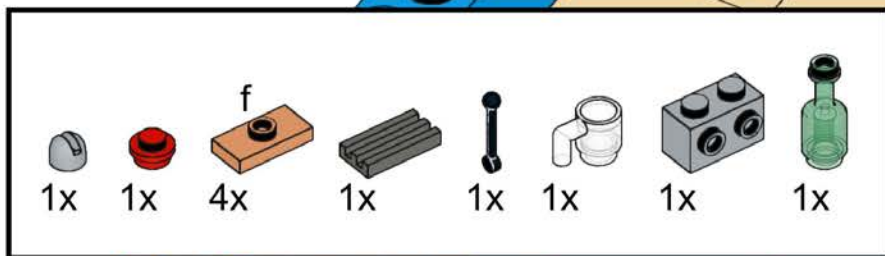

# 357

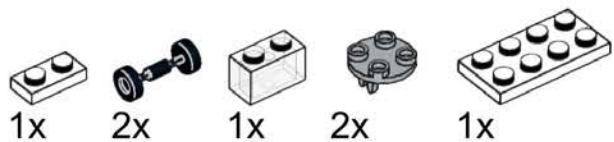

4x

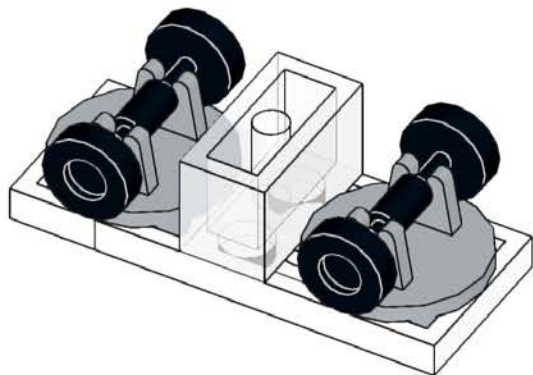

# 359

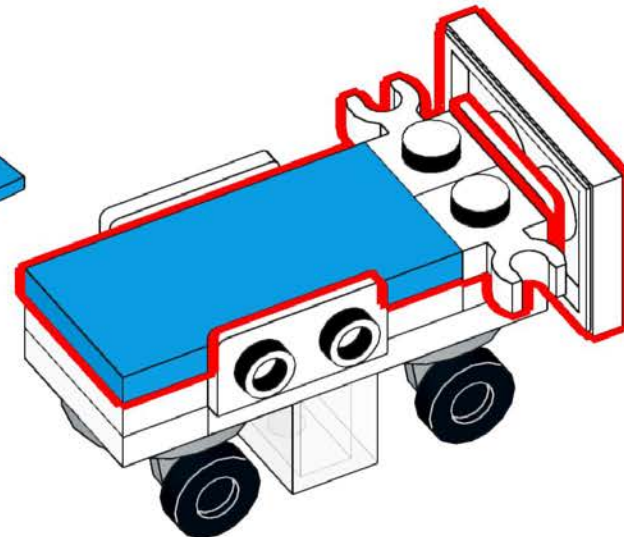
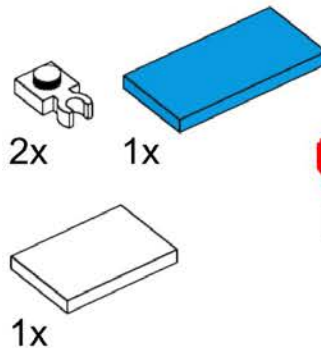

# 358

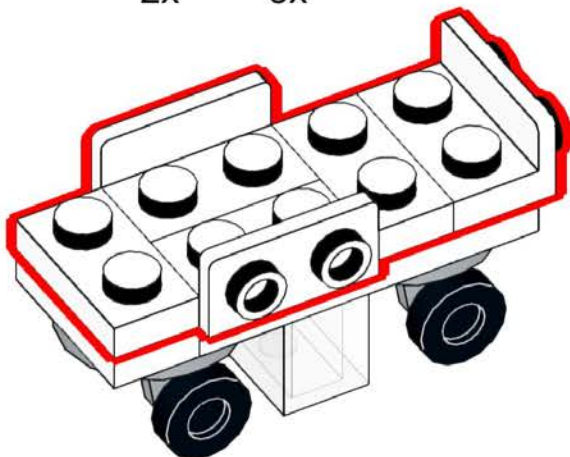
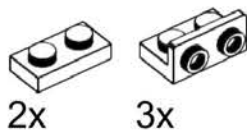

# 360

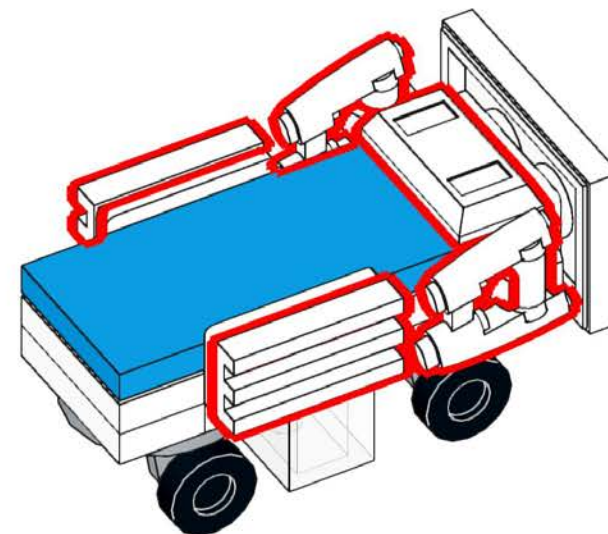
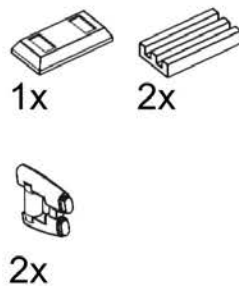

# 361

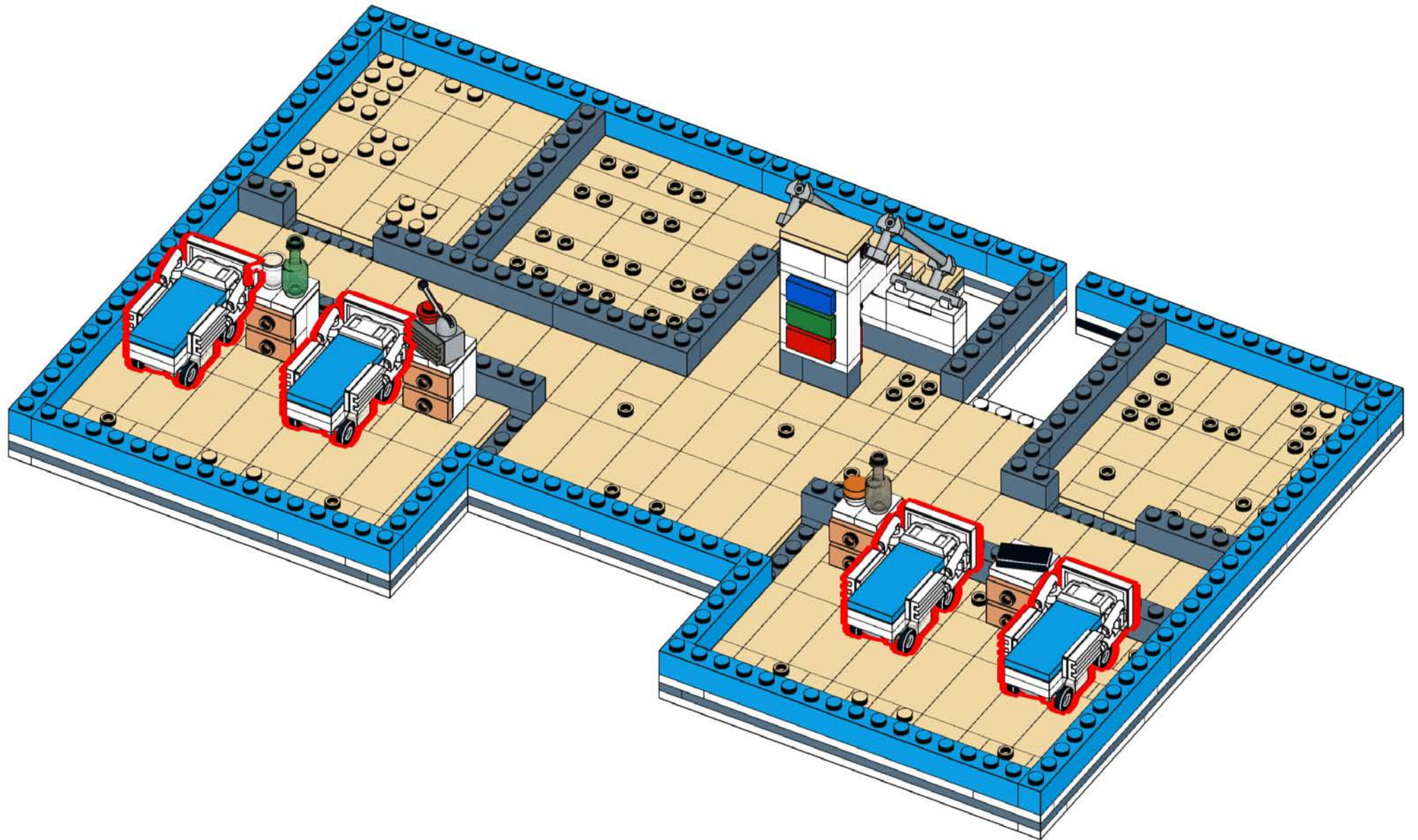

# 362

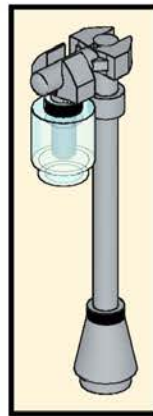
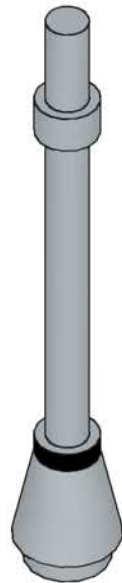
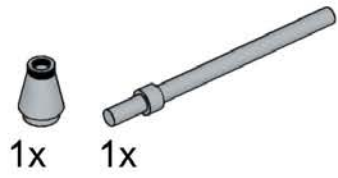

4x

# 363

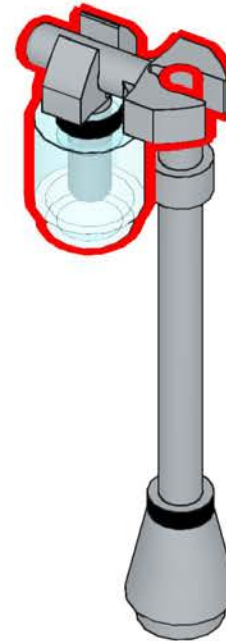

# 364

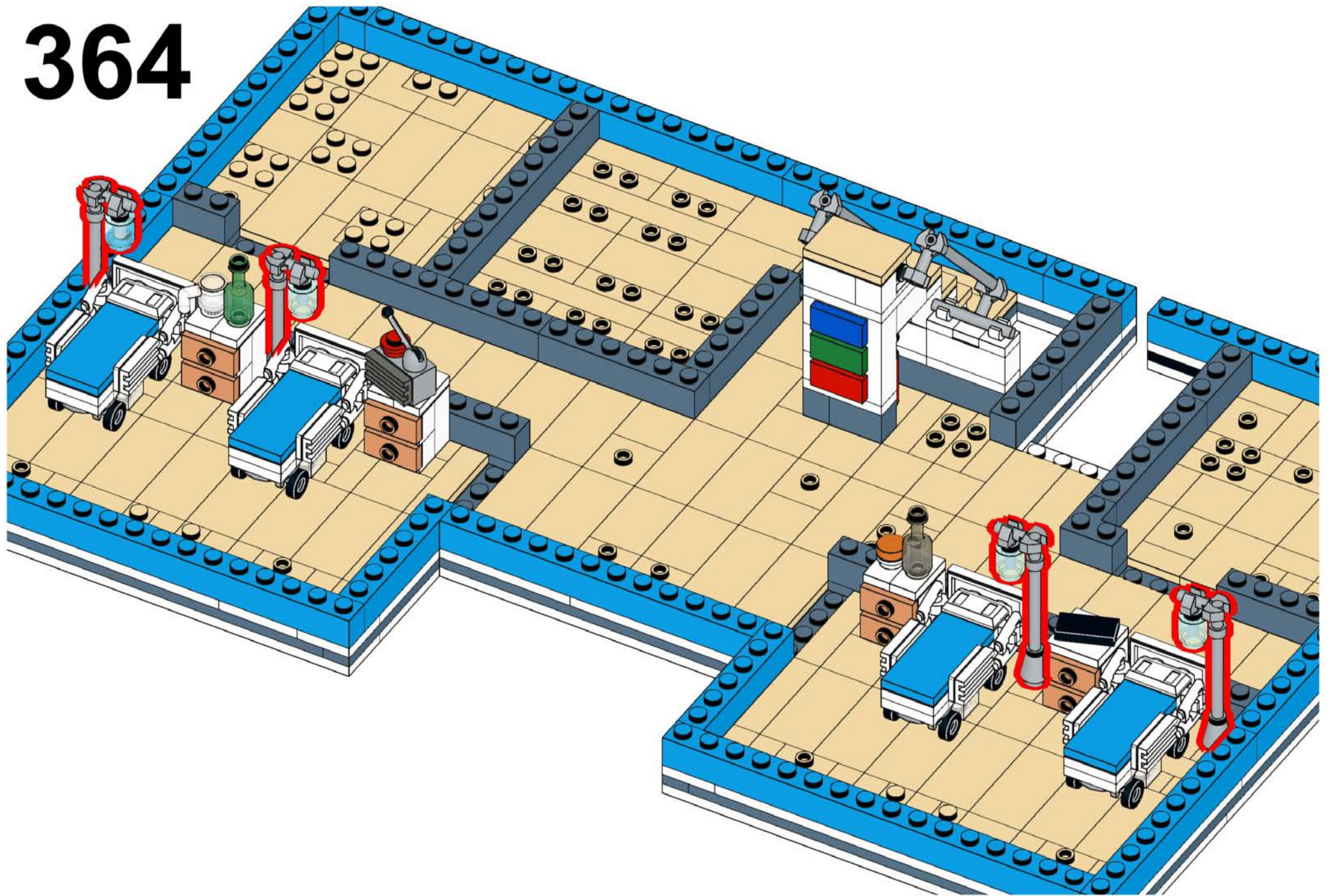

# 365

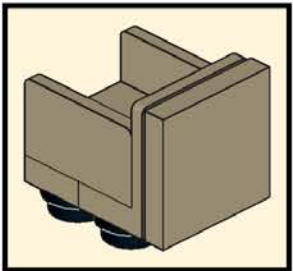
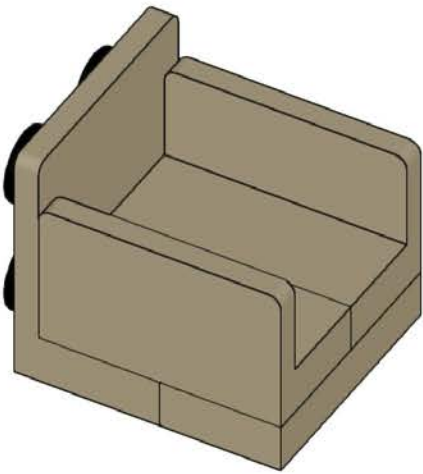
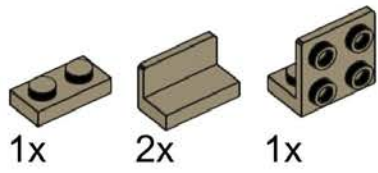

4x

# 366

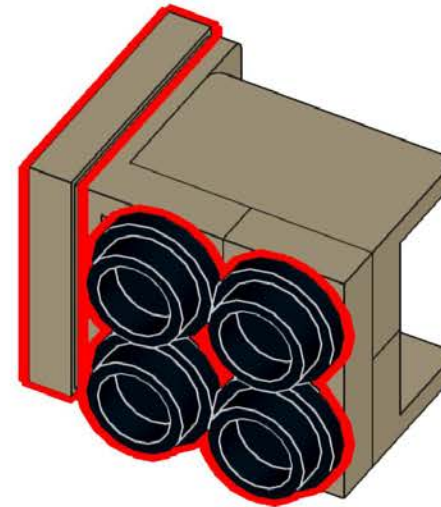
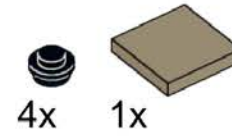

# 367

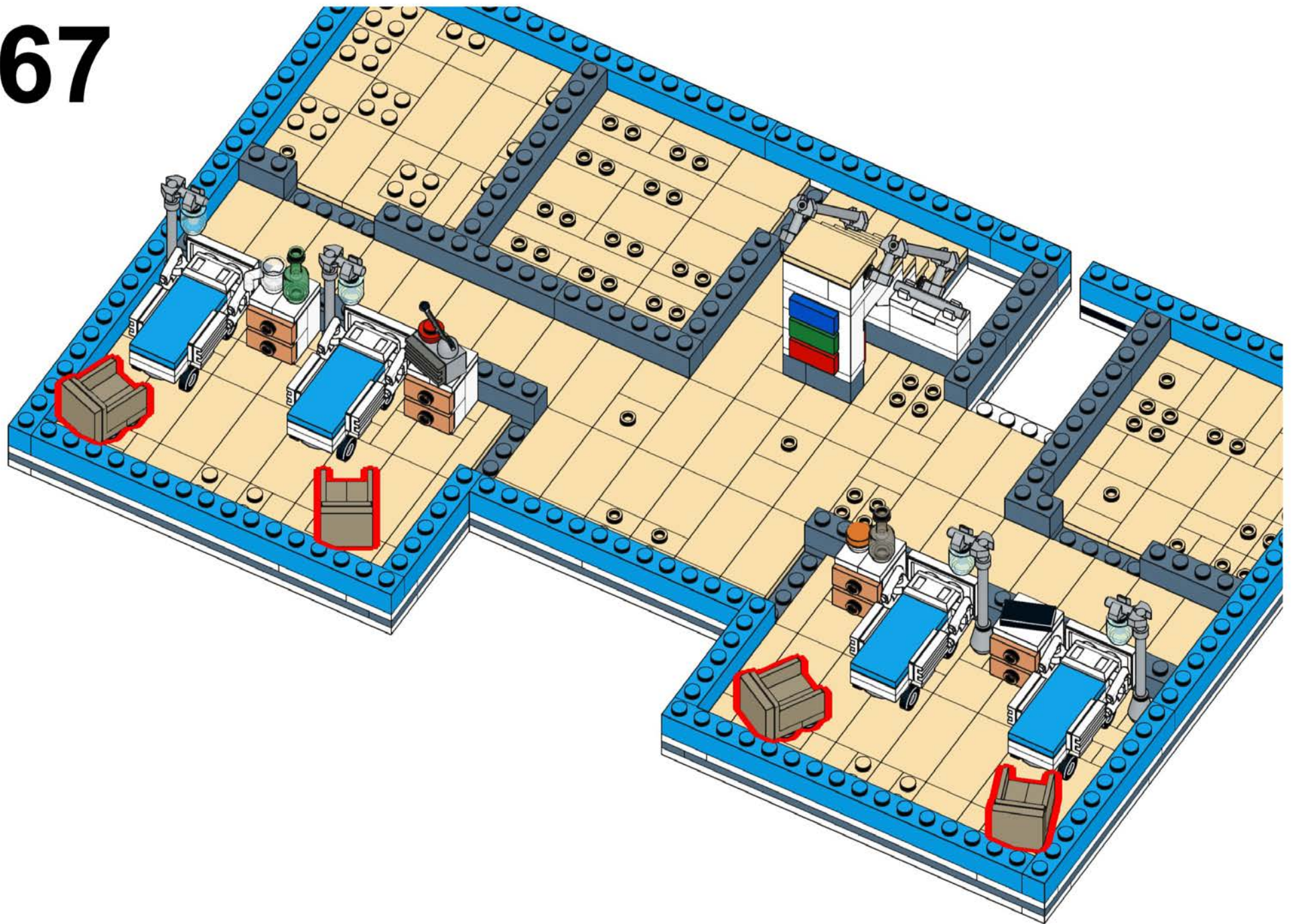



# 368

mdf



1x



1x



3x

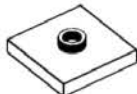

1x



1x



4x



1x

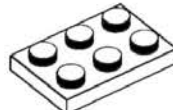

1x

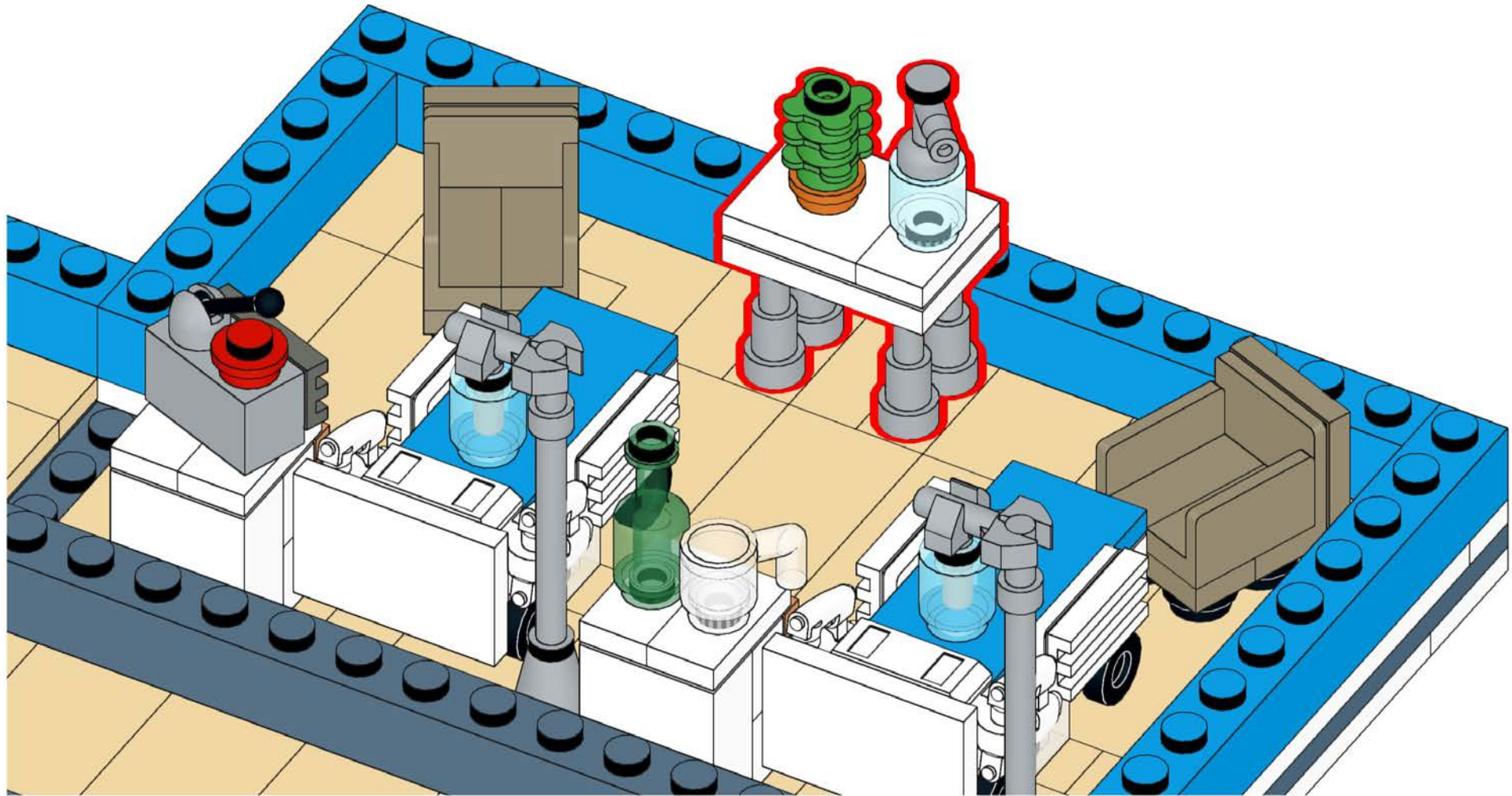



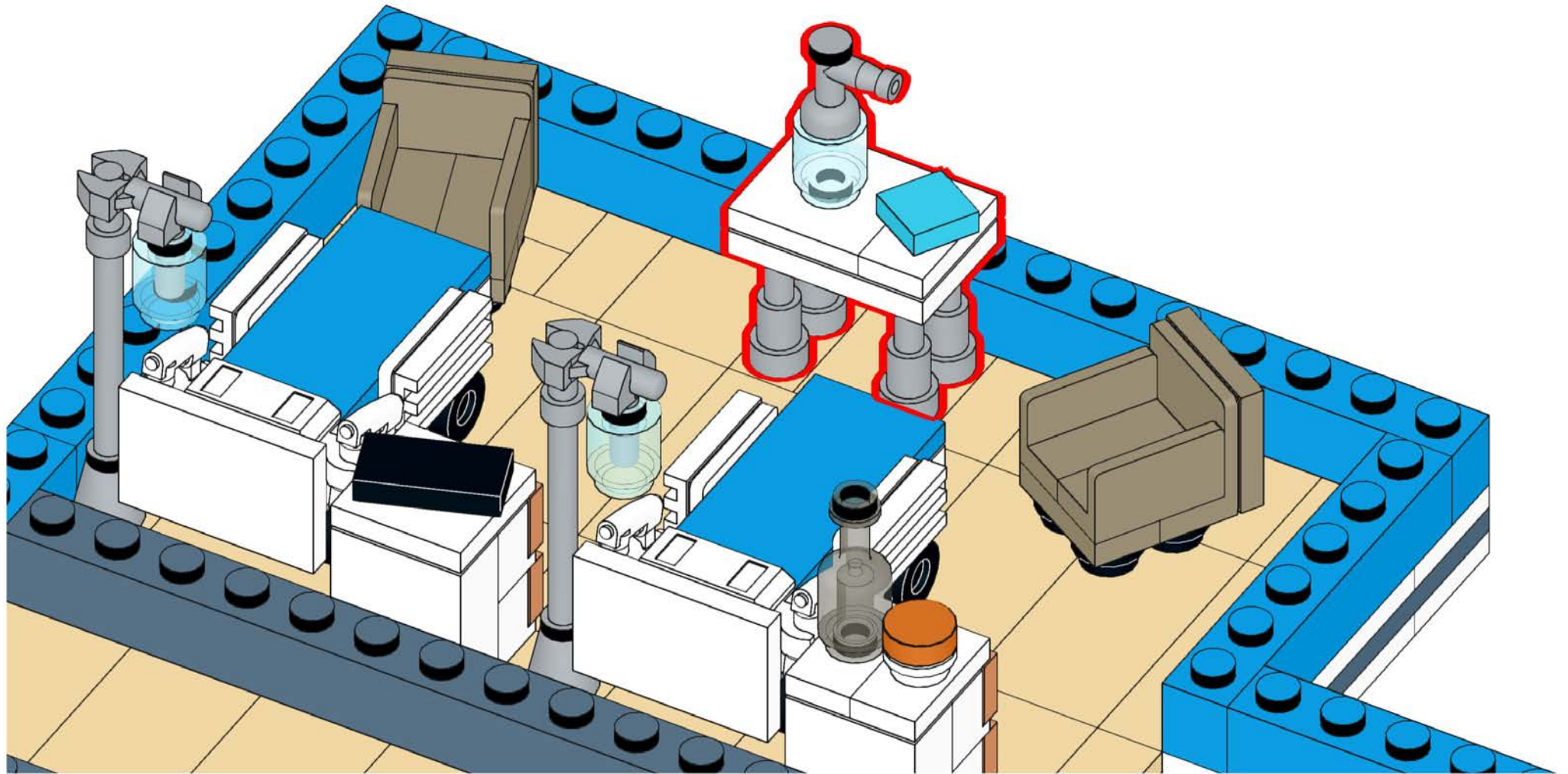
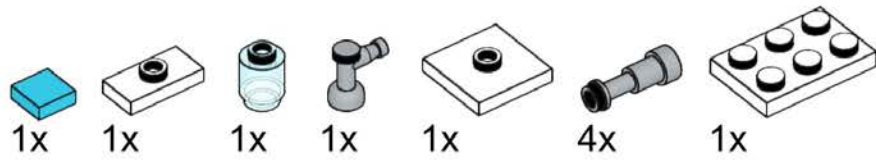



# 369



# 370



- 1x 
- 2x 
- 1x 
- 1x 
- 1x 
- 1x 

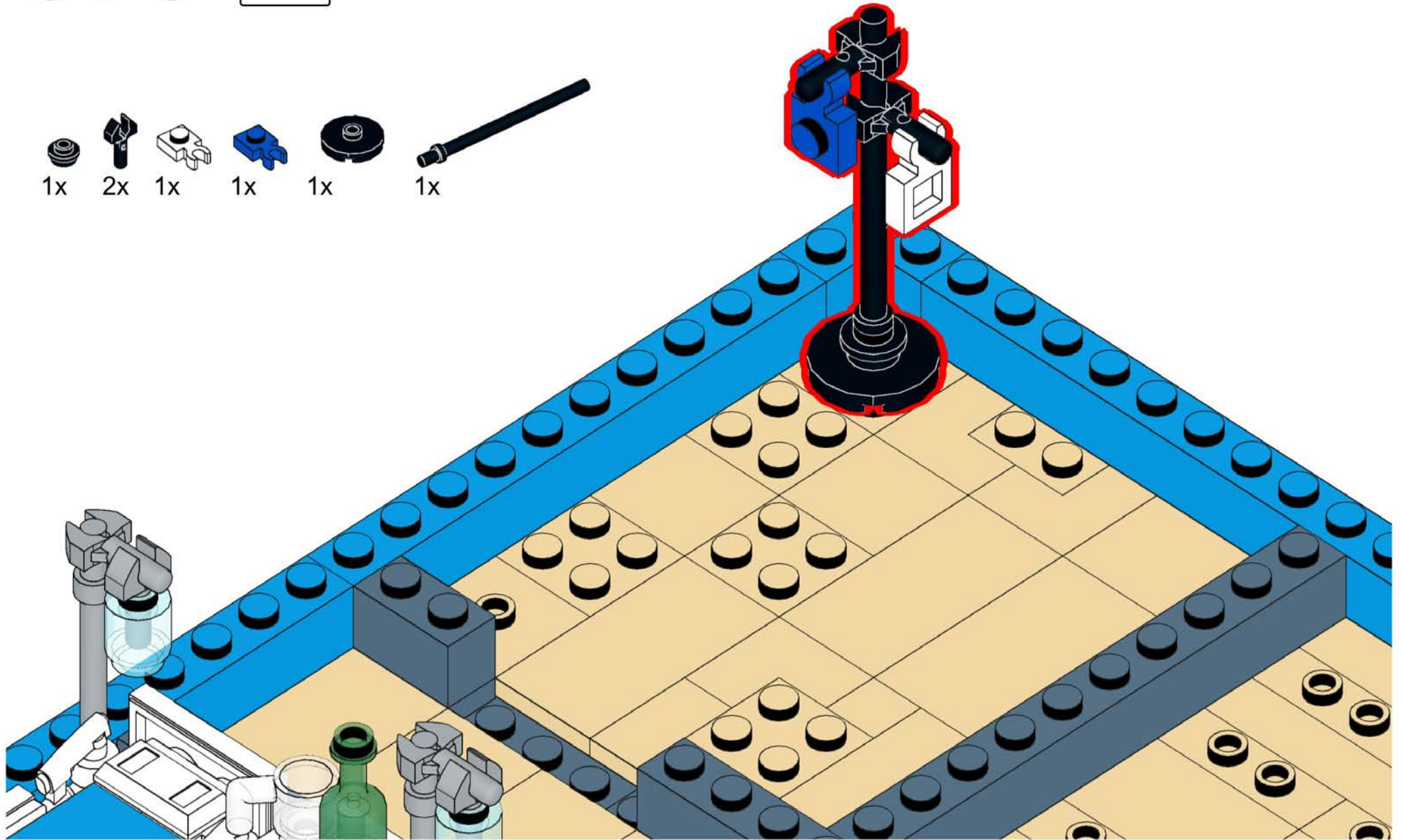

# 371

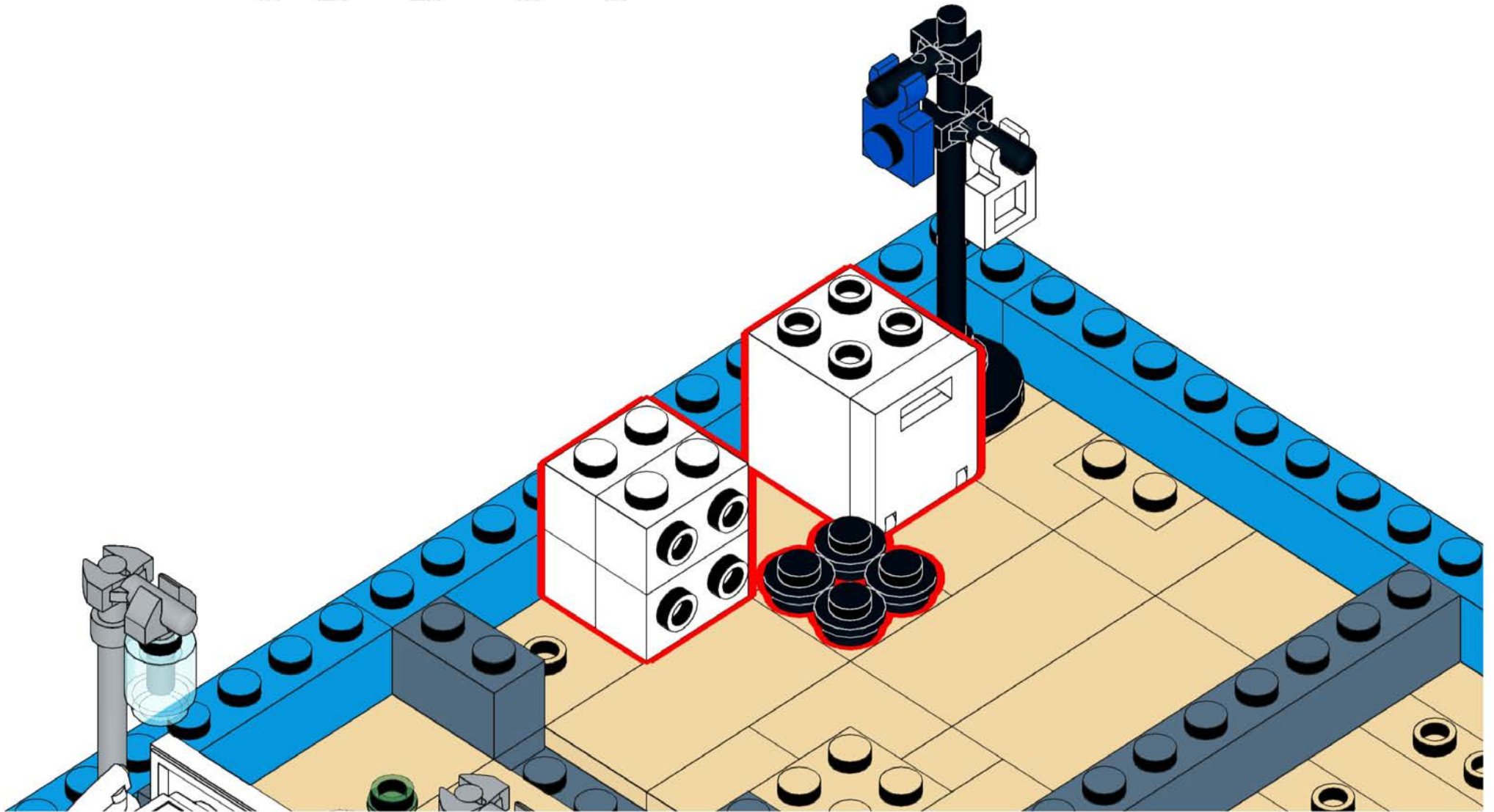
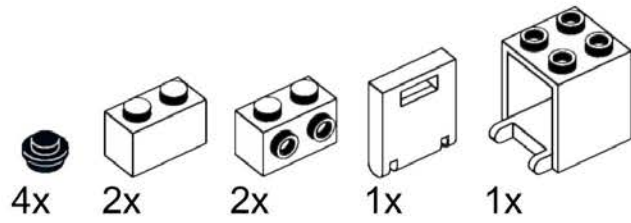

# 372

- 2x 
- 2x 
- 1x 
- 1x 
- 1x 

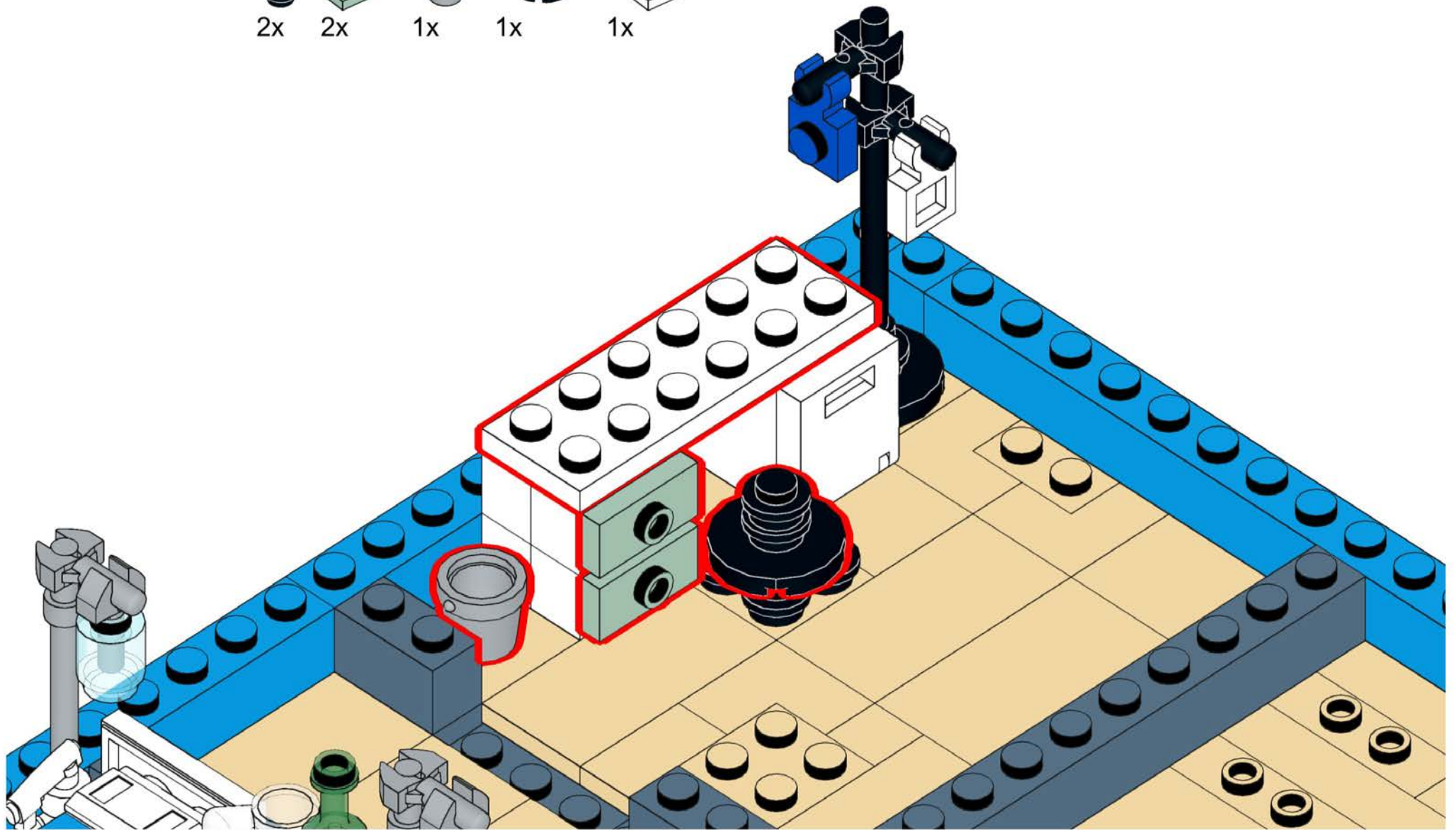

# 373

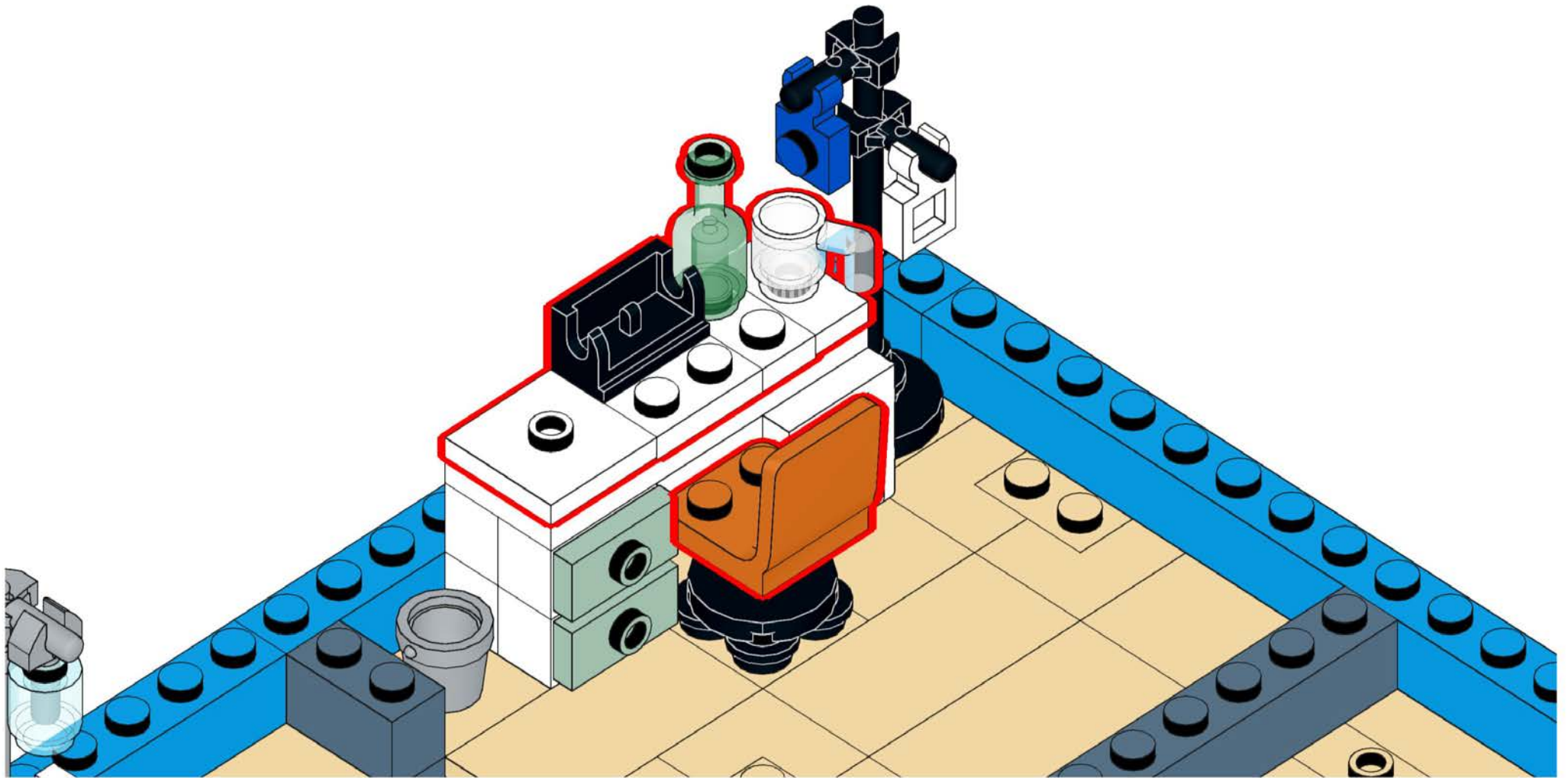
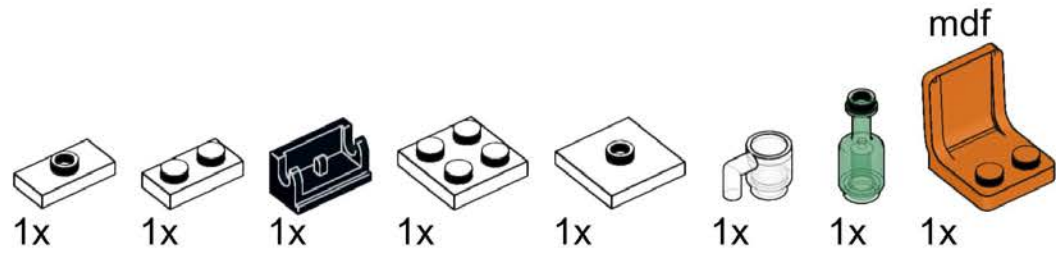

# 374

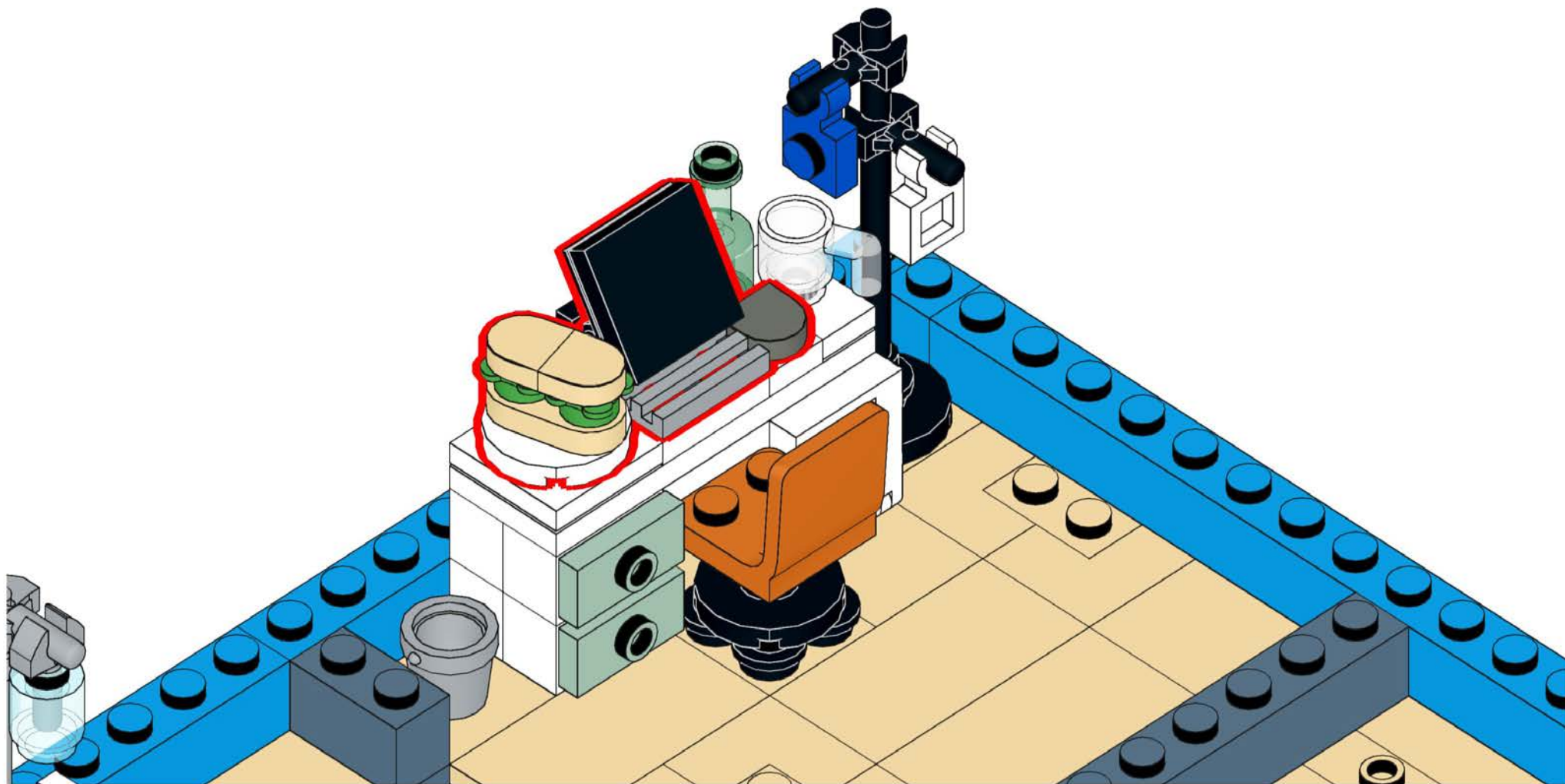
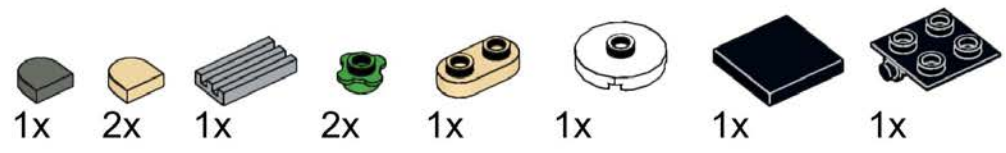

# 375

- 4x 
- 1x mdf 
- 1x 
- 3x 
- 1x 
- 4x 
- 1x 

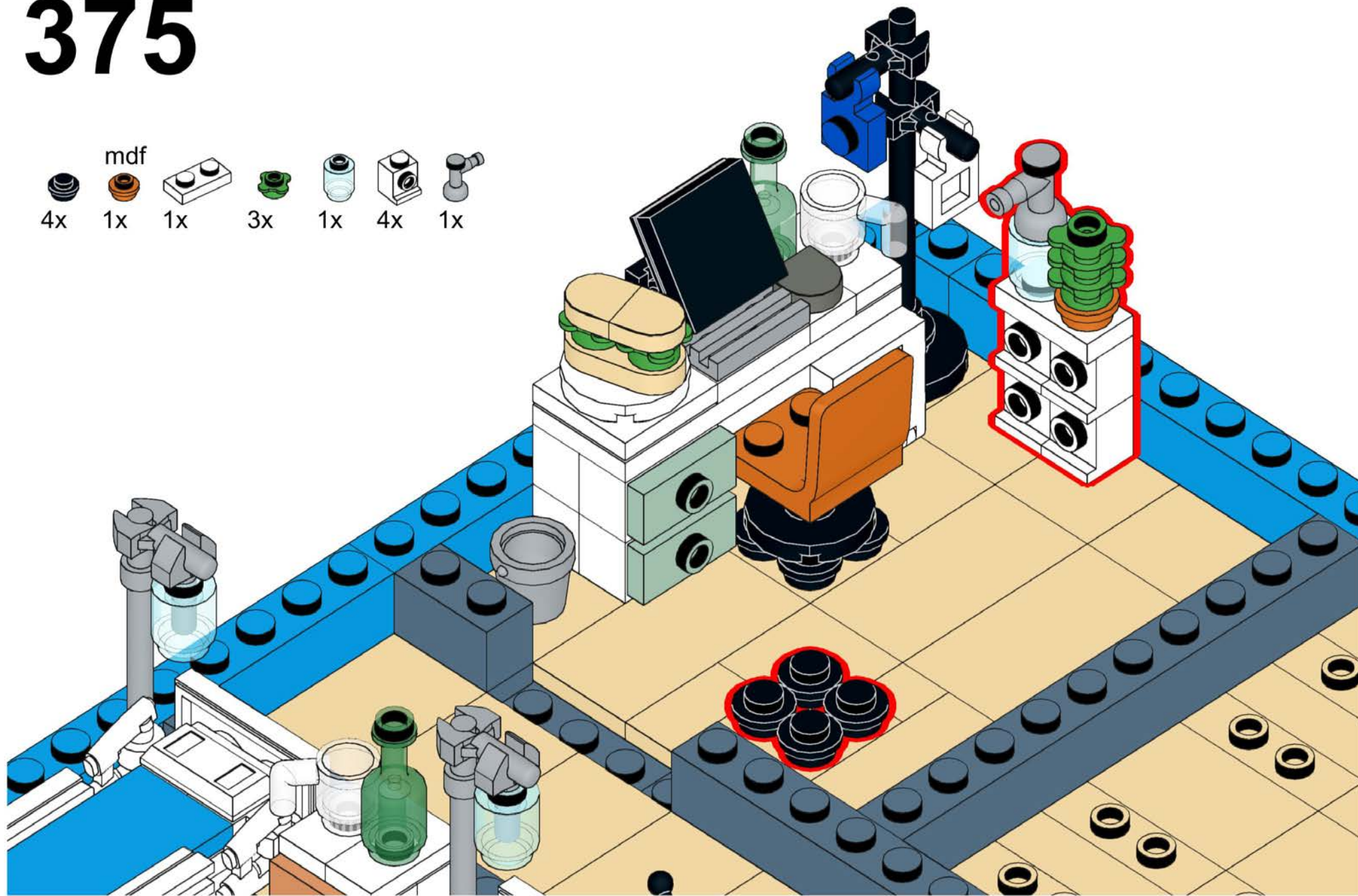



# 376

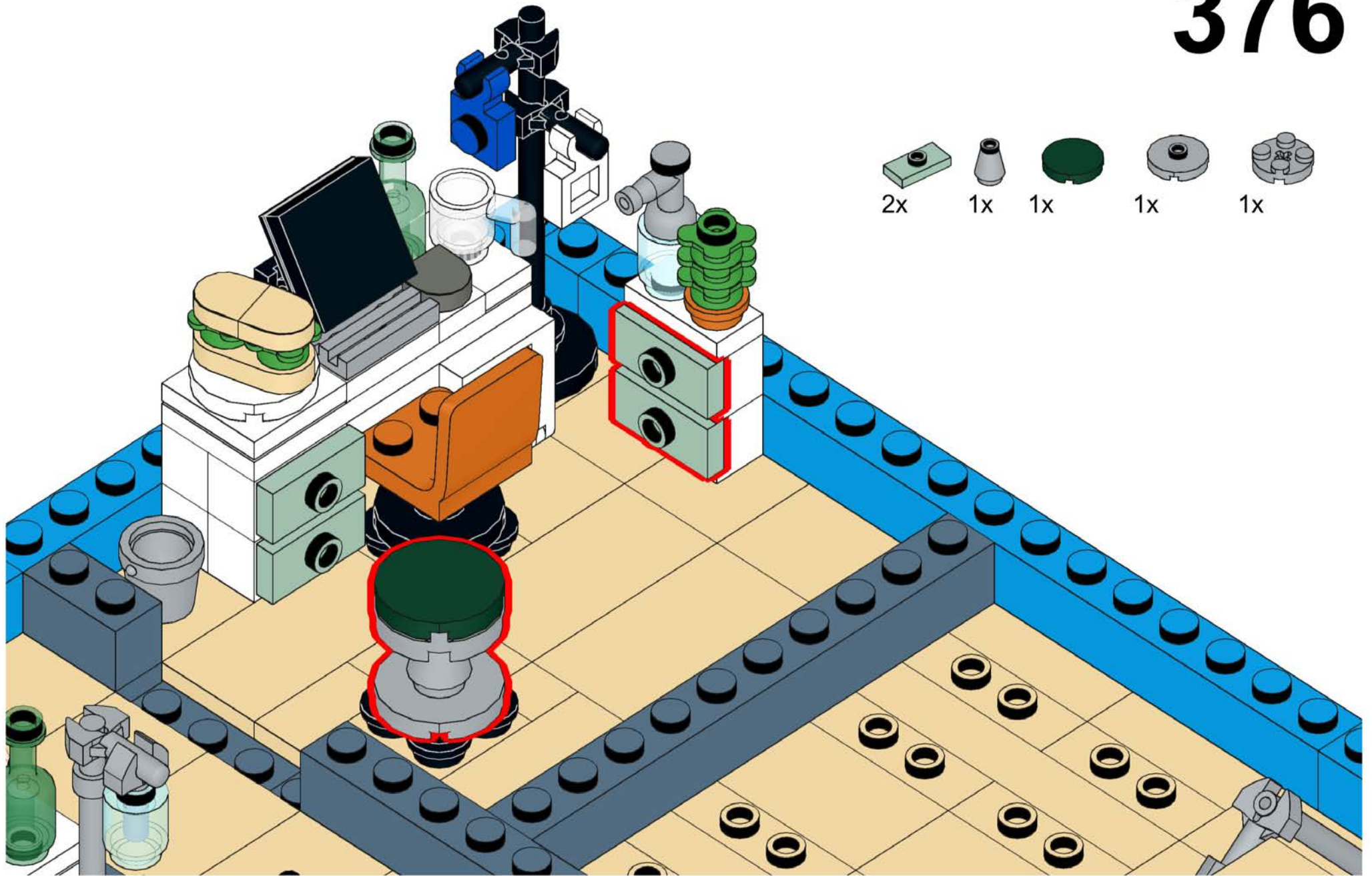

# 377

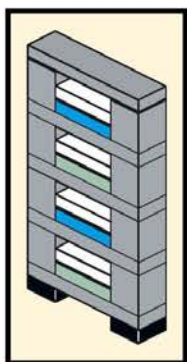
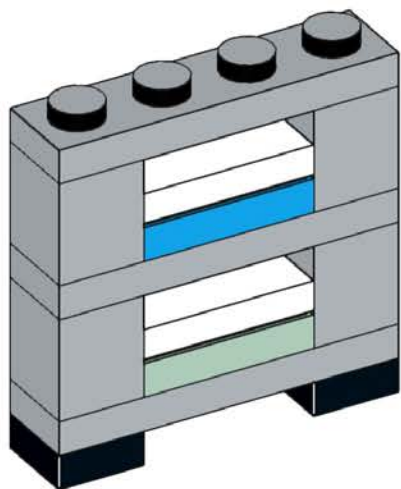
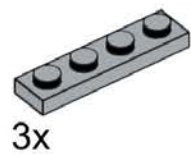
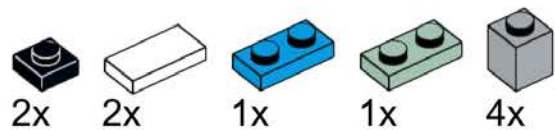

# 378

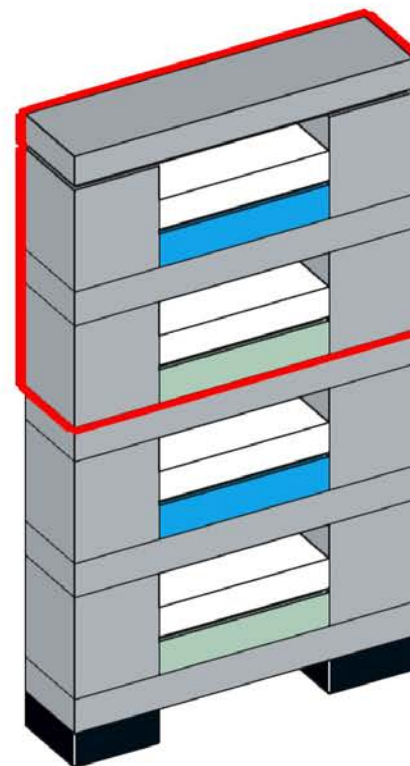
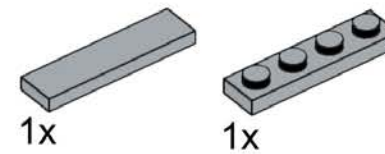
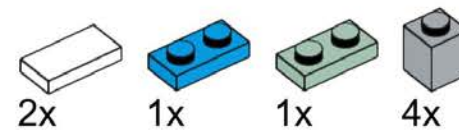

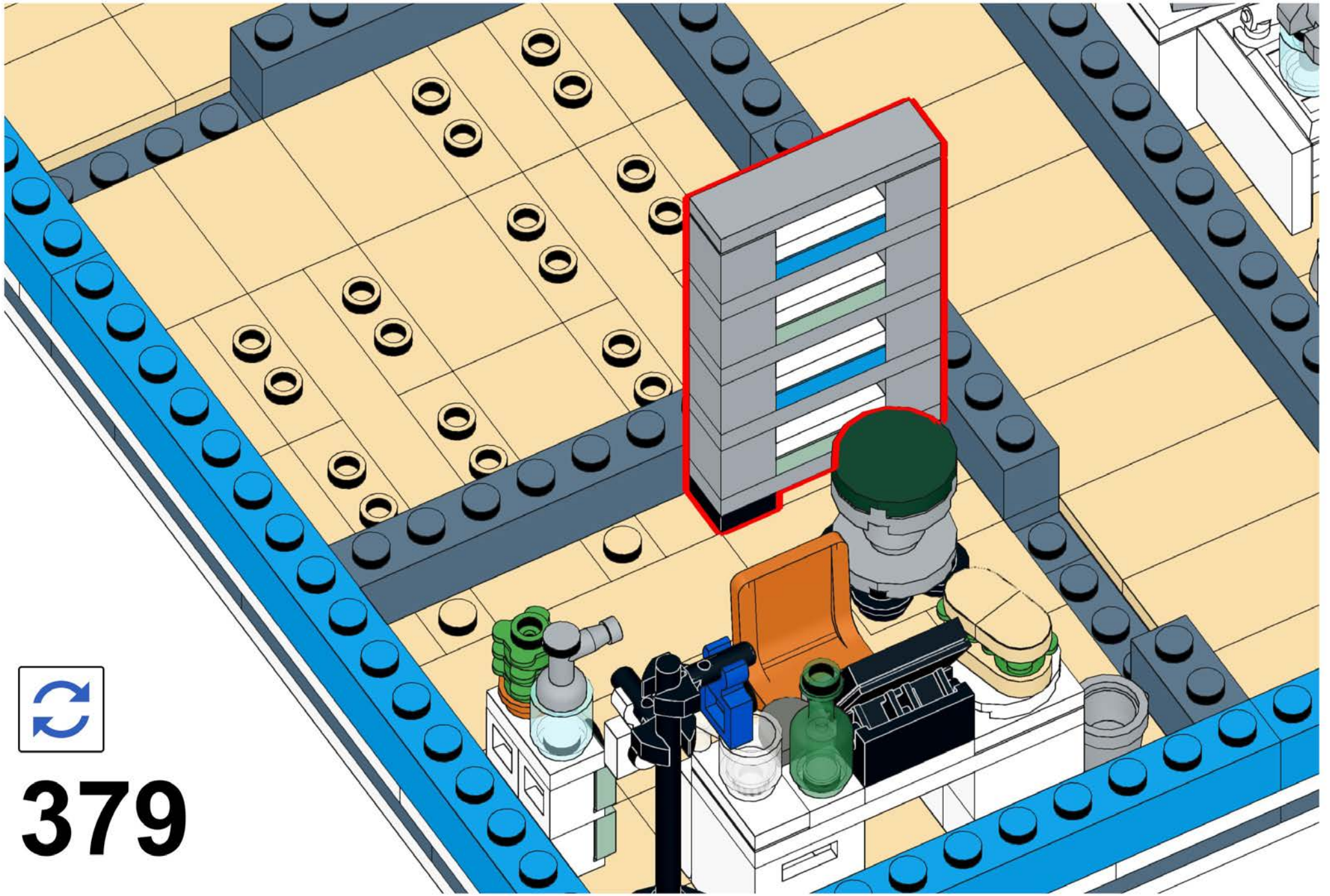

379

# 380

- 1x [White 1x1 Plate]
- 2x [Black 1x1 Brick with Hole]
- 1x [Orange 1x1 Bottle]
- 1x [Light Blue 1x1 Bottle]
- 1x [Clear 1x1 Bottle]
- 4x [Grey 1x1 Brick with Hole]

- 3x [Grey 1x4 Technic Beam]

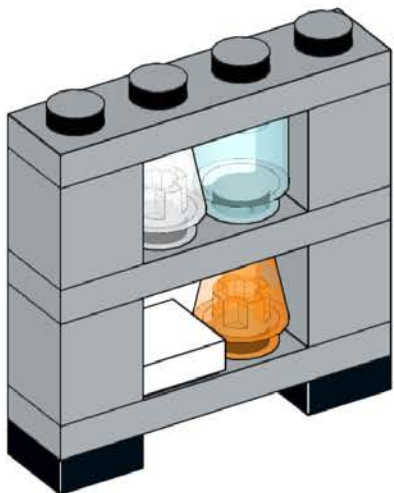
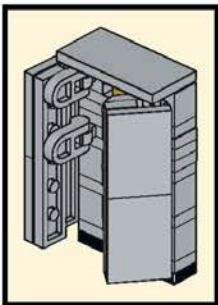

# 381

- 1x [White 1x1 Plate]
- 4x [Grey 1x1 Brick with Hole]
- 2x [Grey 1x2 Technic Connector]
- 1x [Dark Grey 1x1 Bottle]
- 1x [Clear 1x1 Bottle]
- 1x [Yellow 1x1 Pin with Friction Ridge]

- 2x [Grey 1x2 Technic Connector]
- 1x [Grey 1x4 Technic Beam]

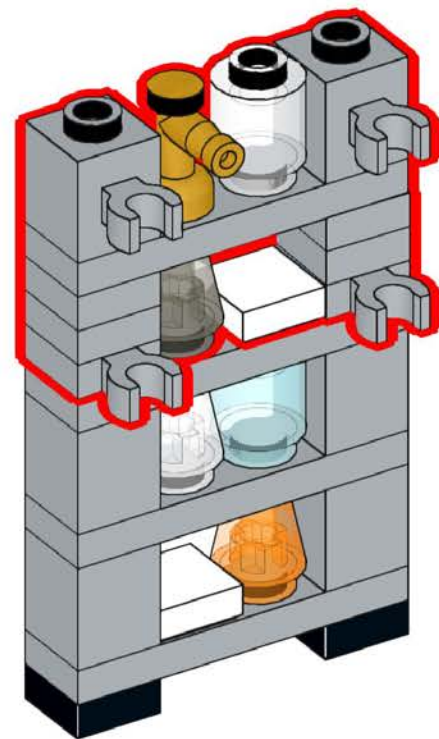

# 382

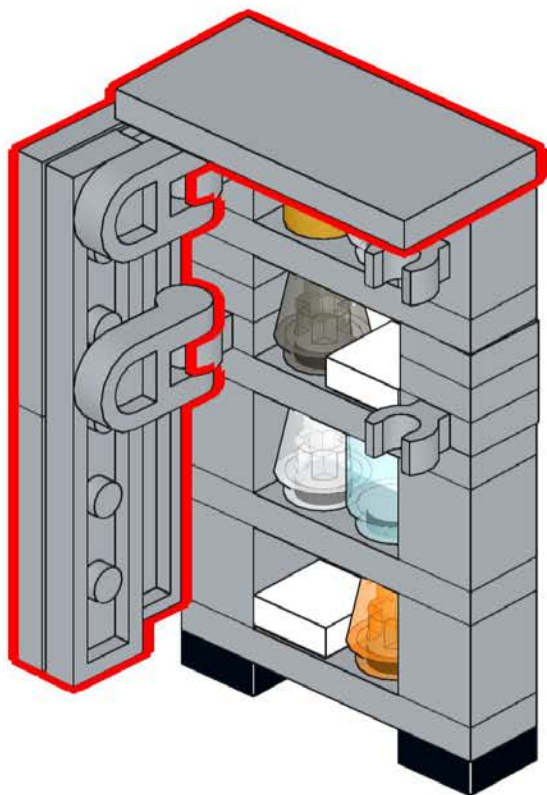
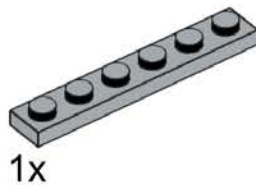
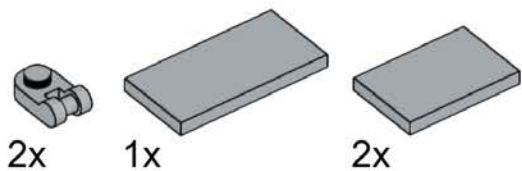

# 383

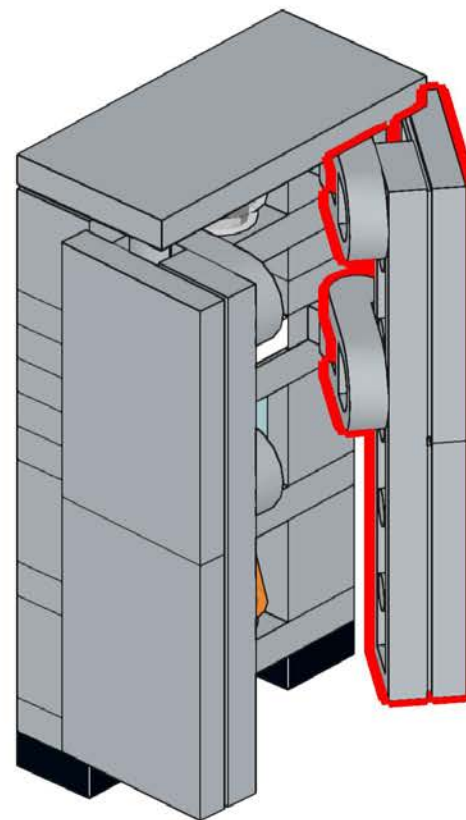
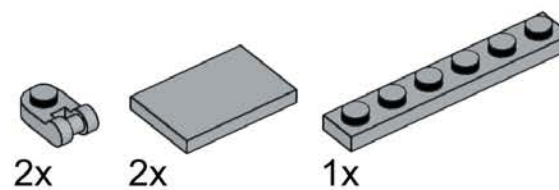

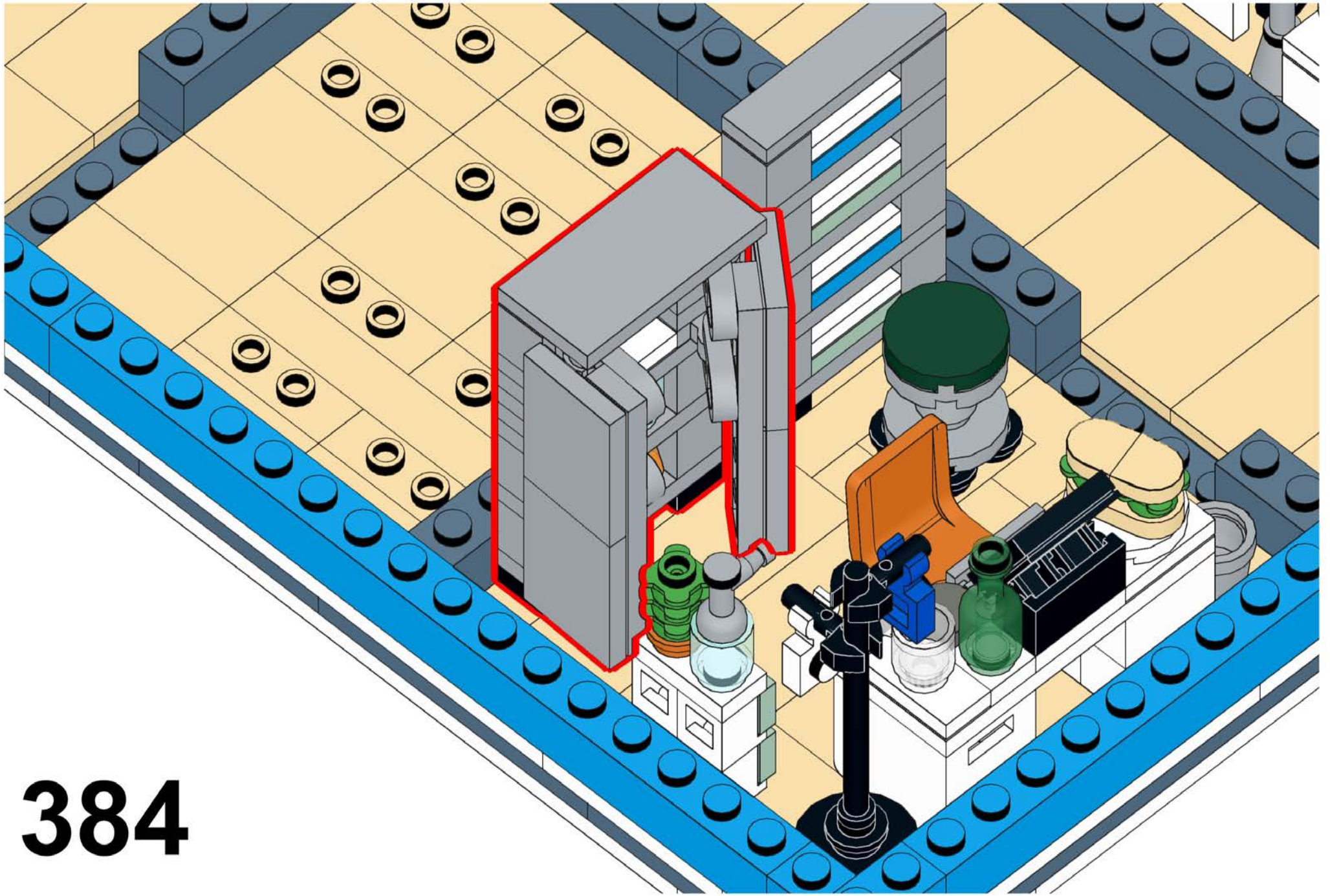

384

# 385

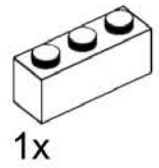
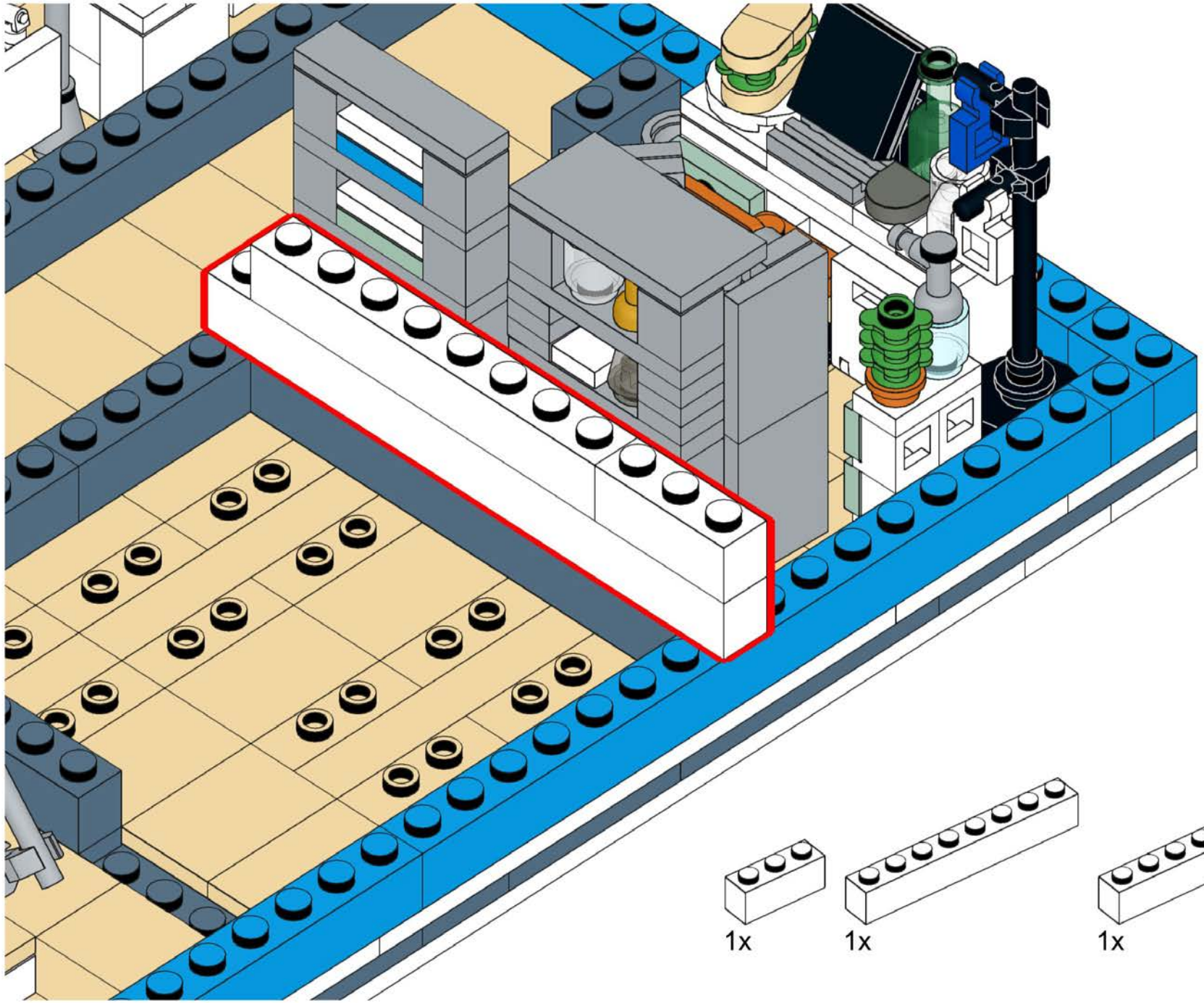

1x

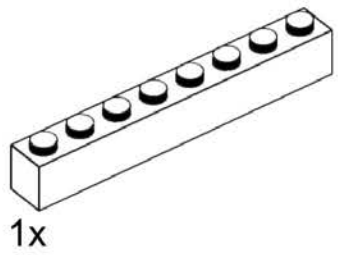

1x

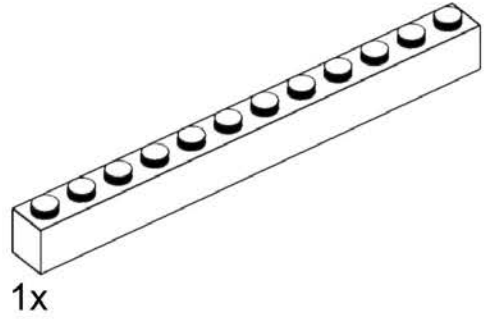

1x

# 386

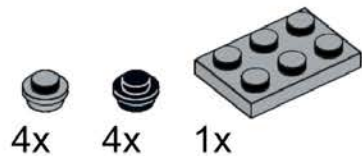

5x

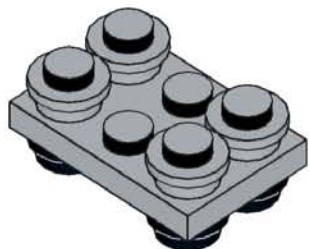

# 388

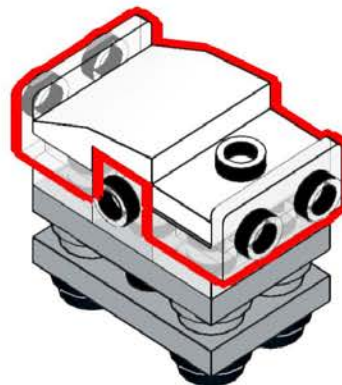
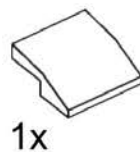
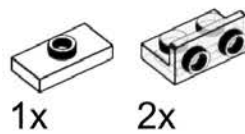

# 387

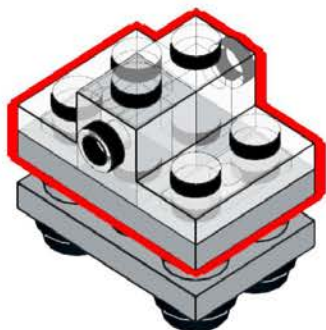
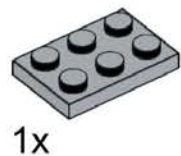
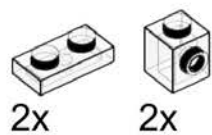

# 389

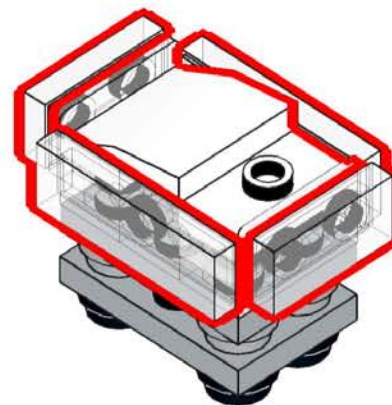



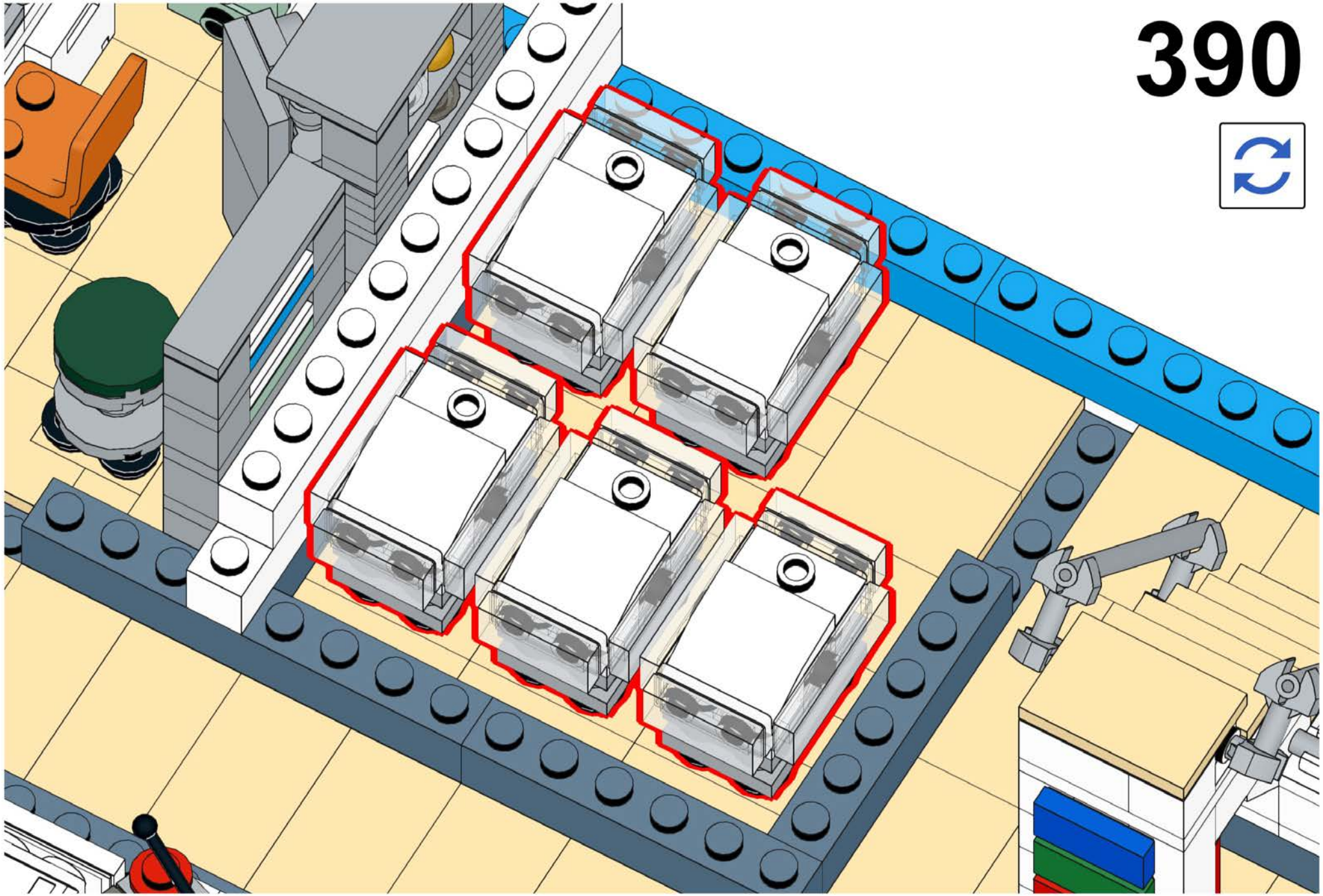

# 390

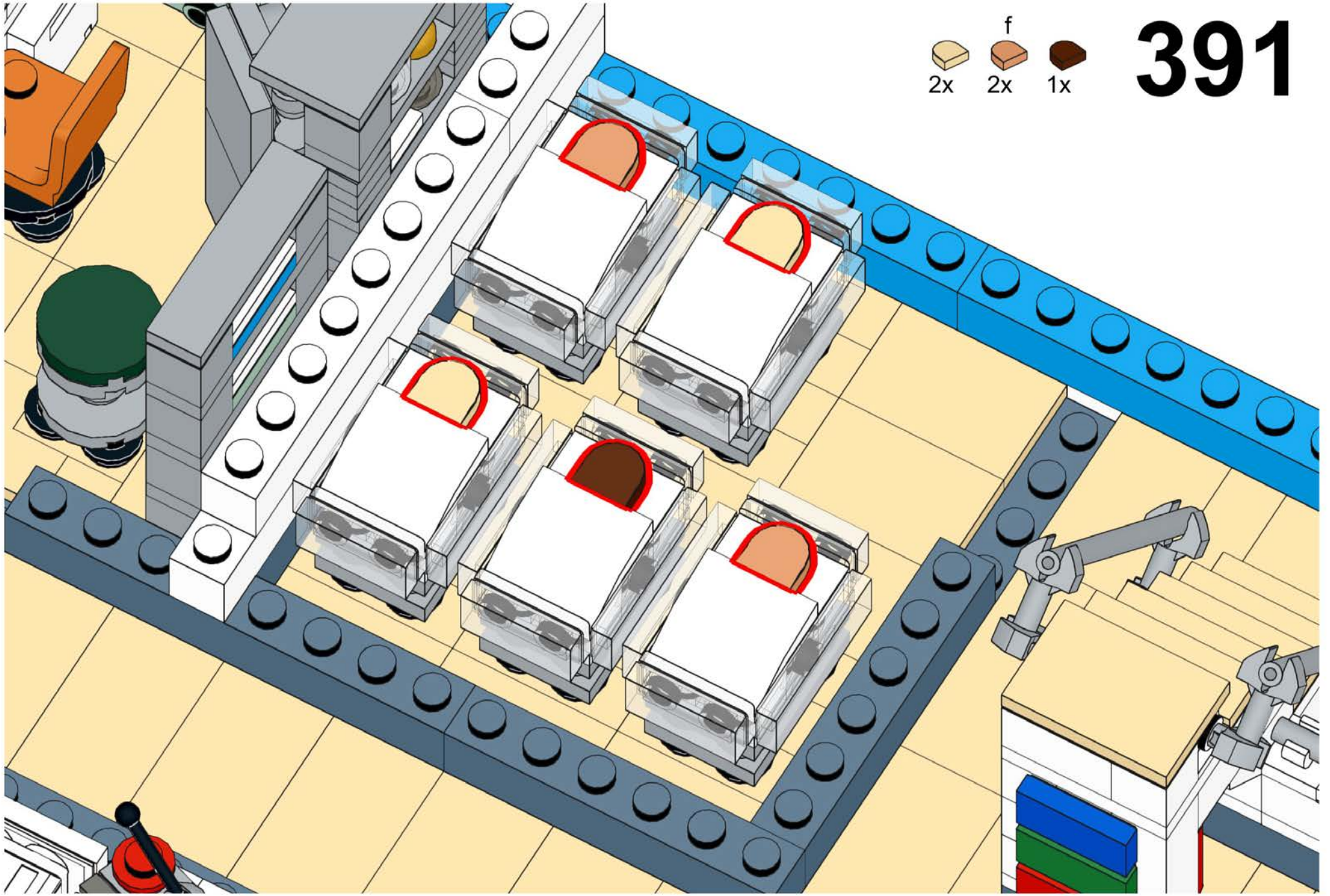



-  2x
-  f 2x
-  1x

# 391

# 392

- 3x [1x1 grey plate]
- 3x [1x3 grey Technic brick with hole]
- 1x [grey Technic cone]
- 1x [grey Technic axle]

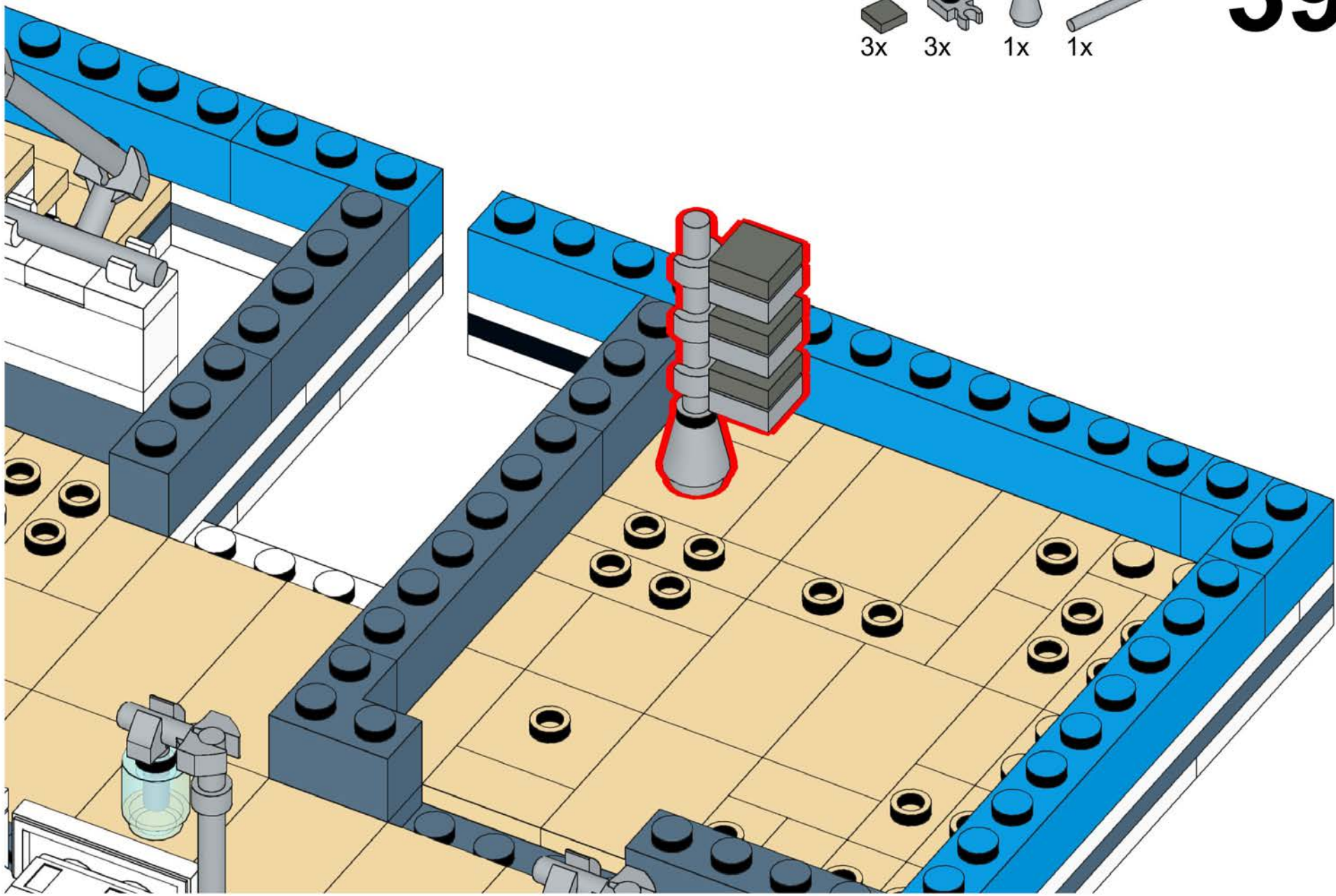

# 393

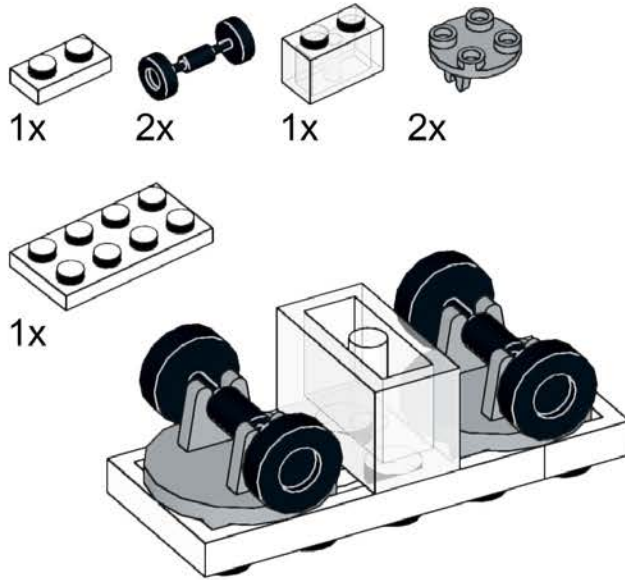
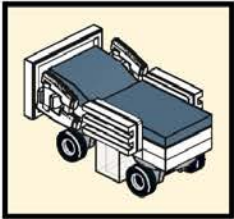

# 395

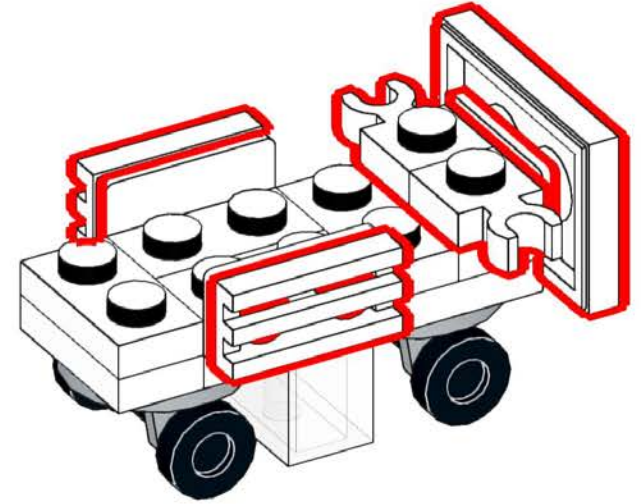
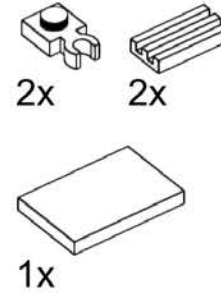

# 394

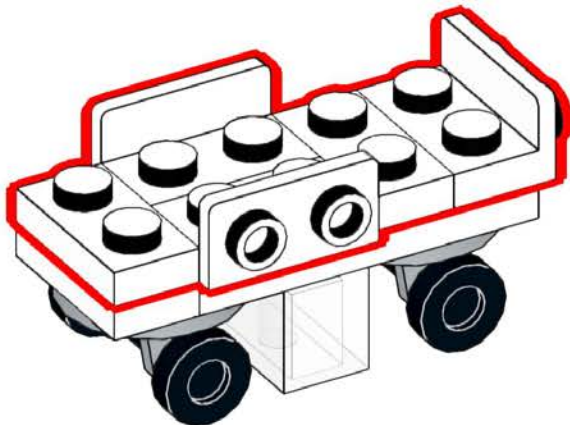
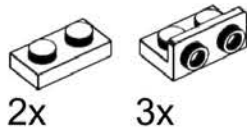

# 396

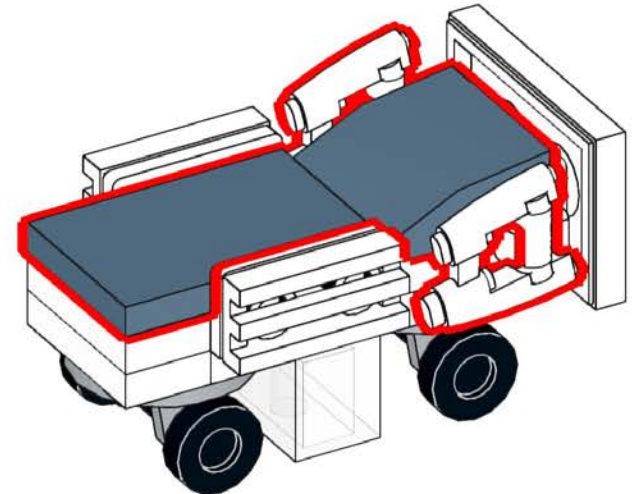
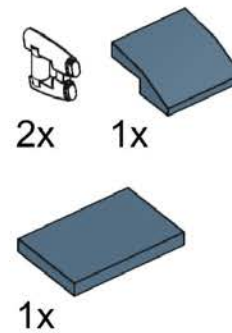



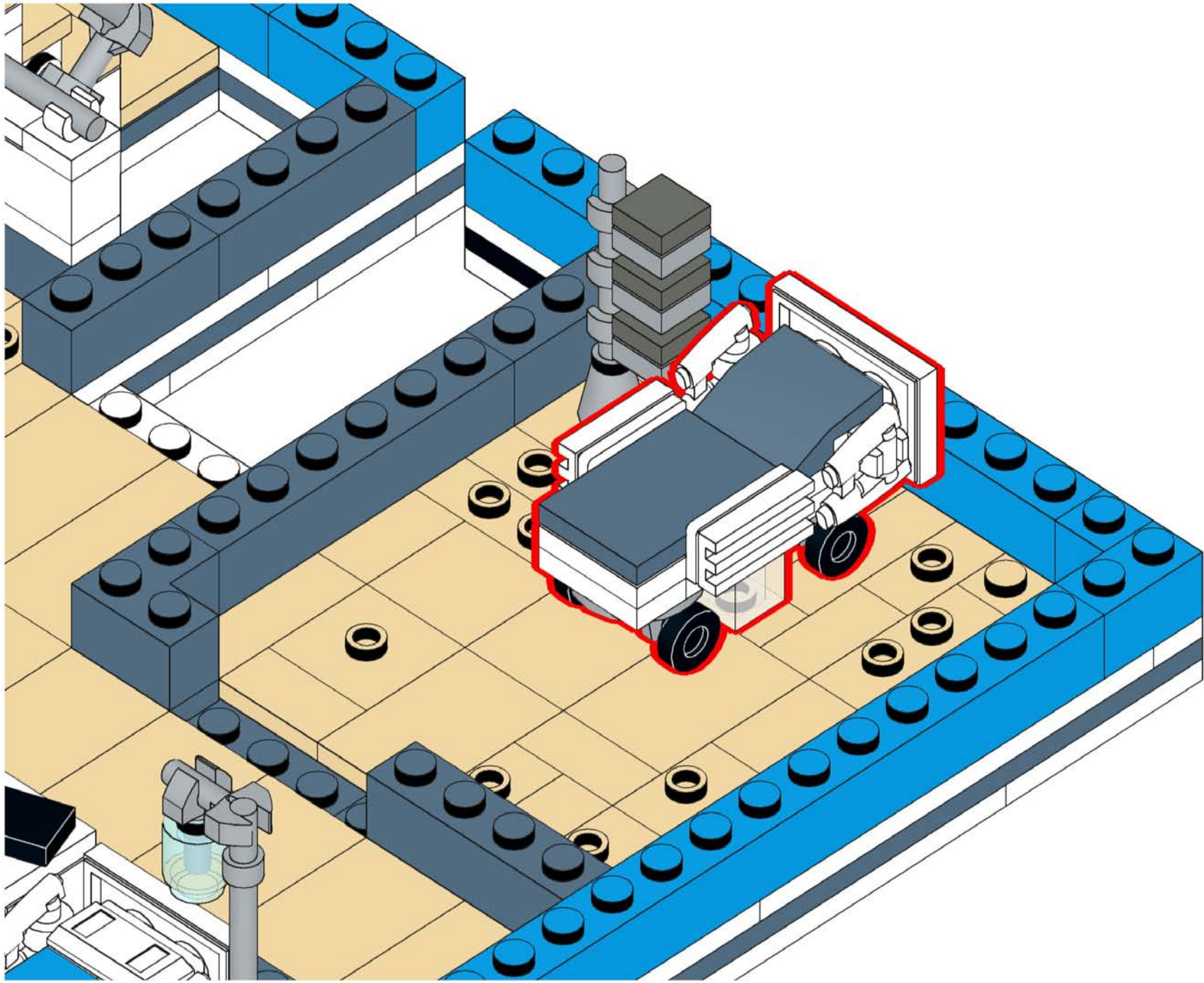

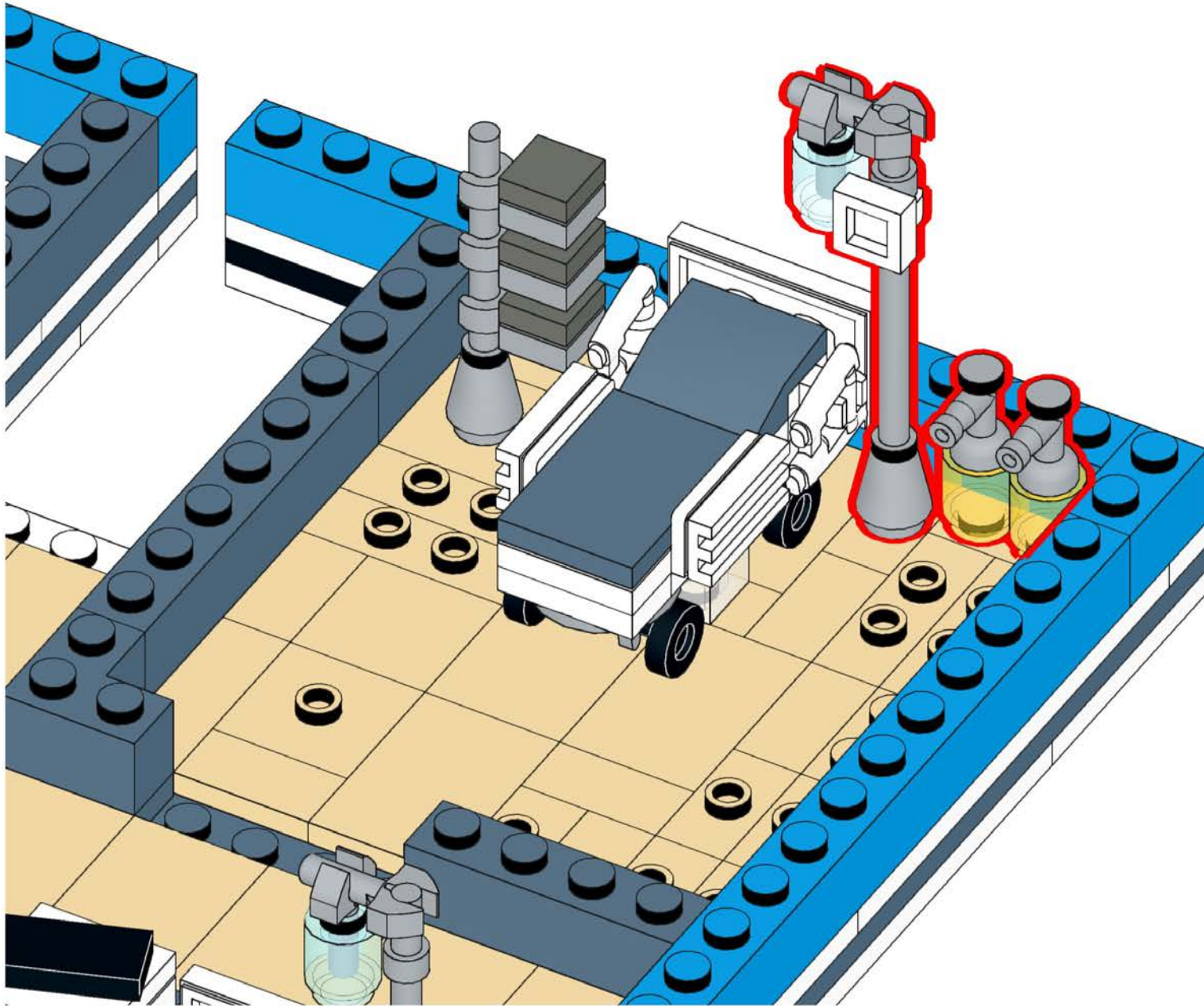

397



# 398

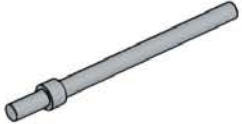

- 2x 
- 1x 
- 2x 
- 1x 
- 1x 
- 2x 
- 1x 

# 399

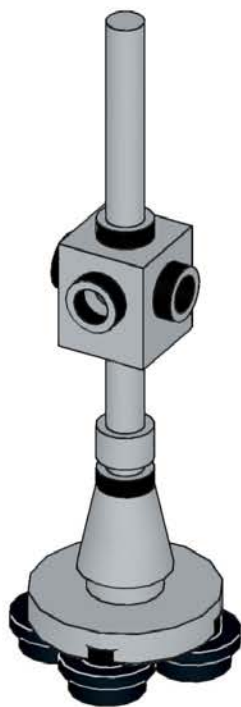
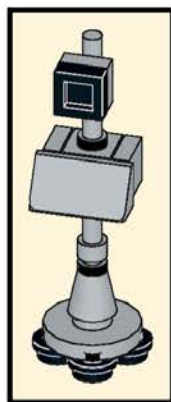
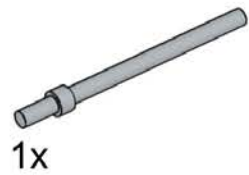
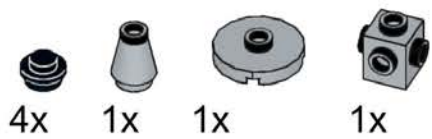

# 400

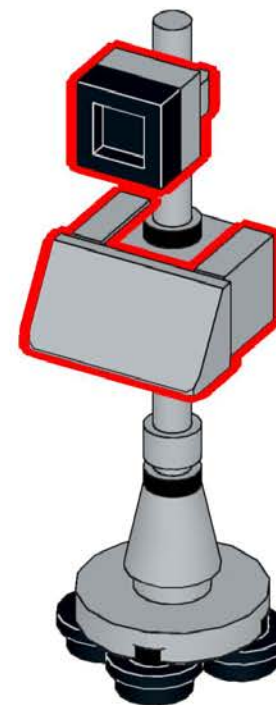
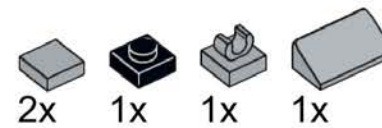

# 401

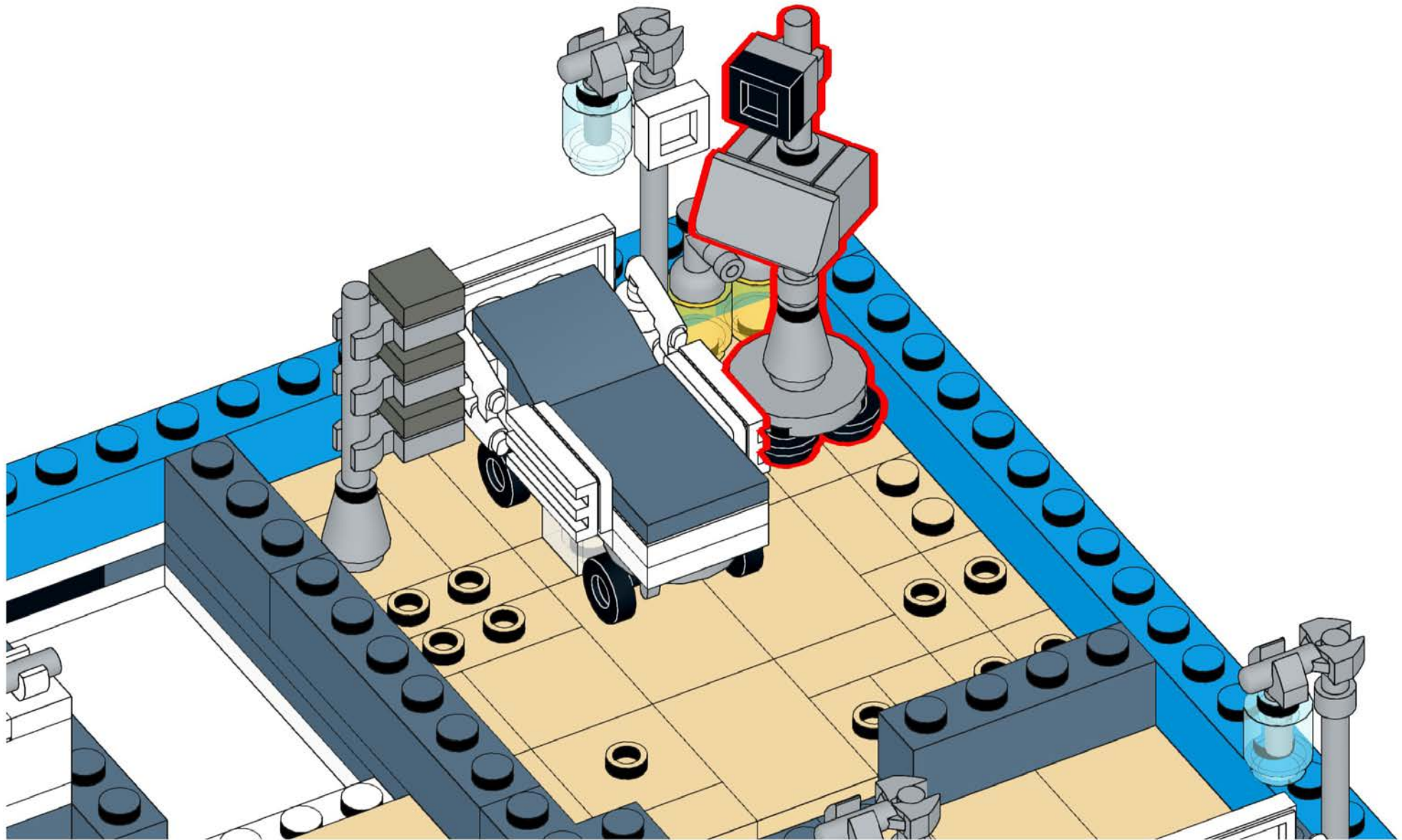



# 402

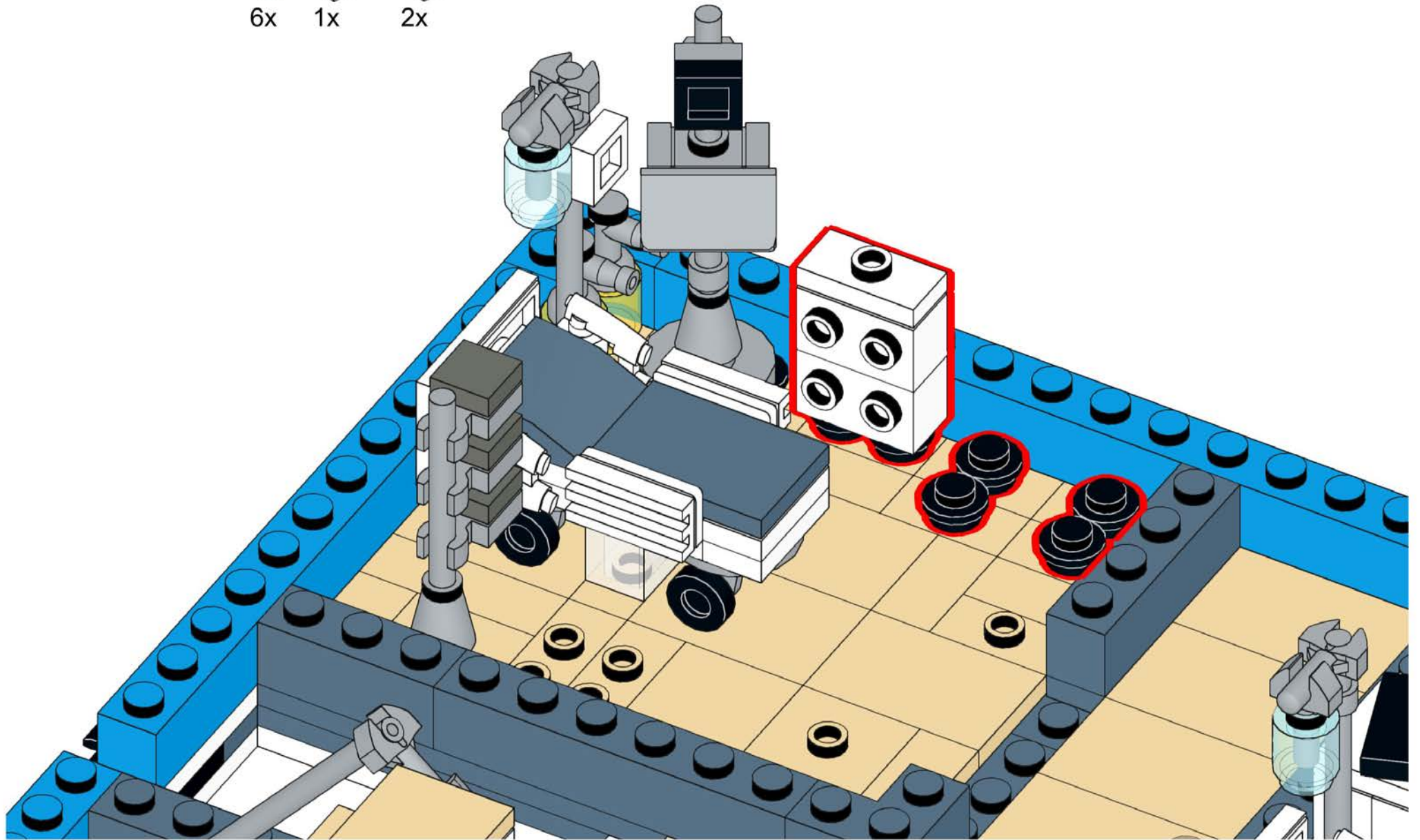
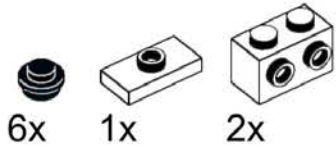

# 403

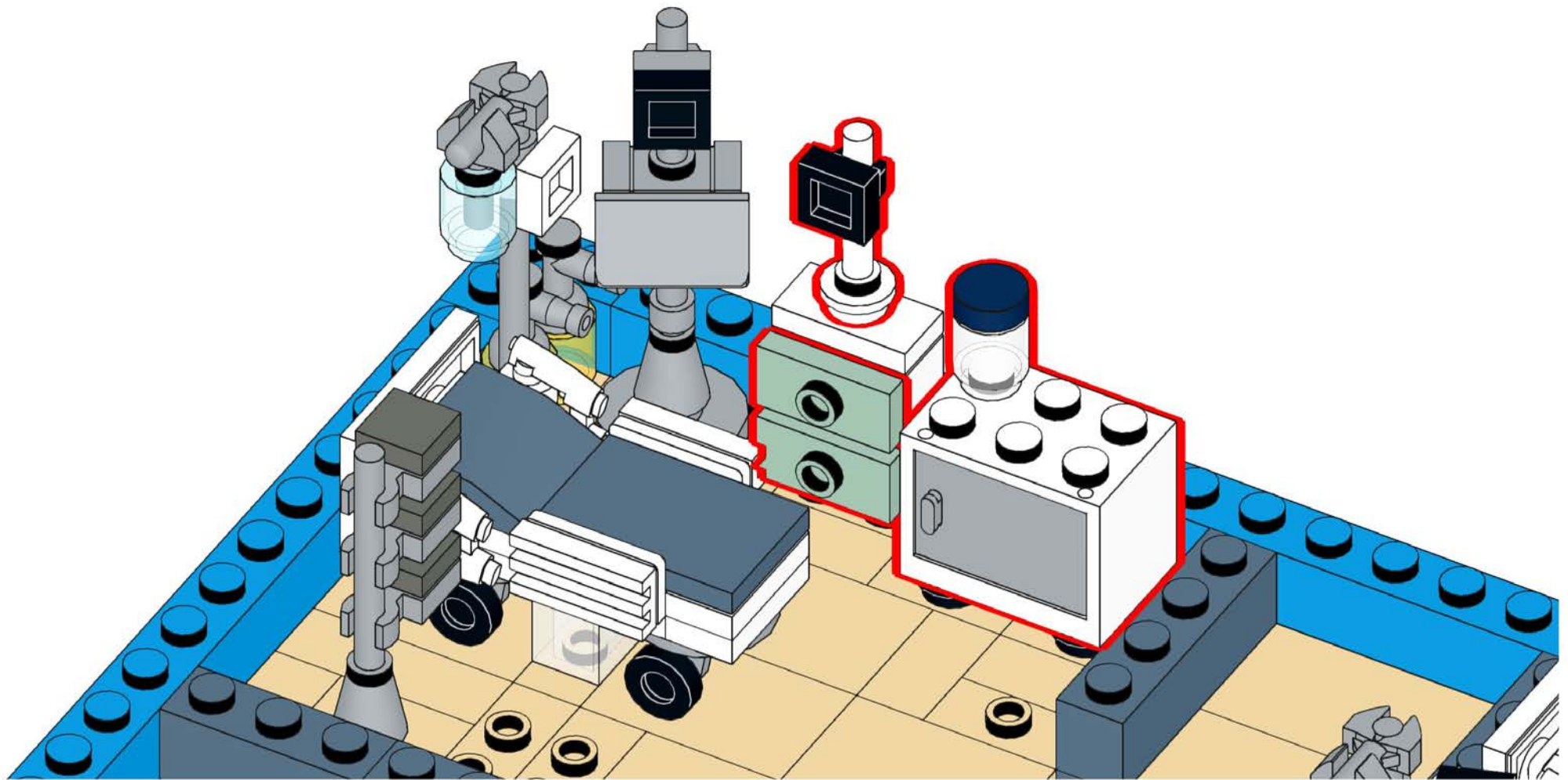
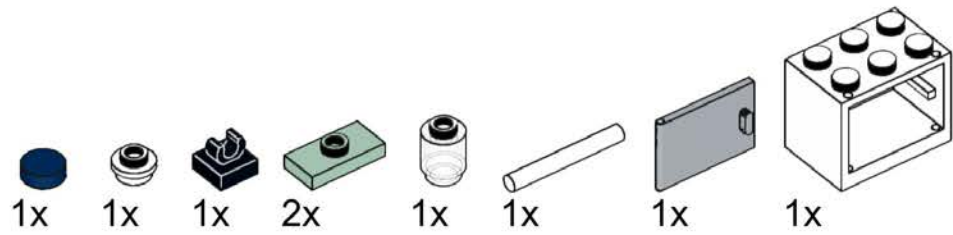

# 404

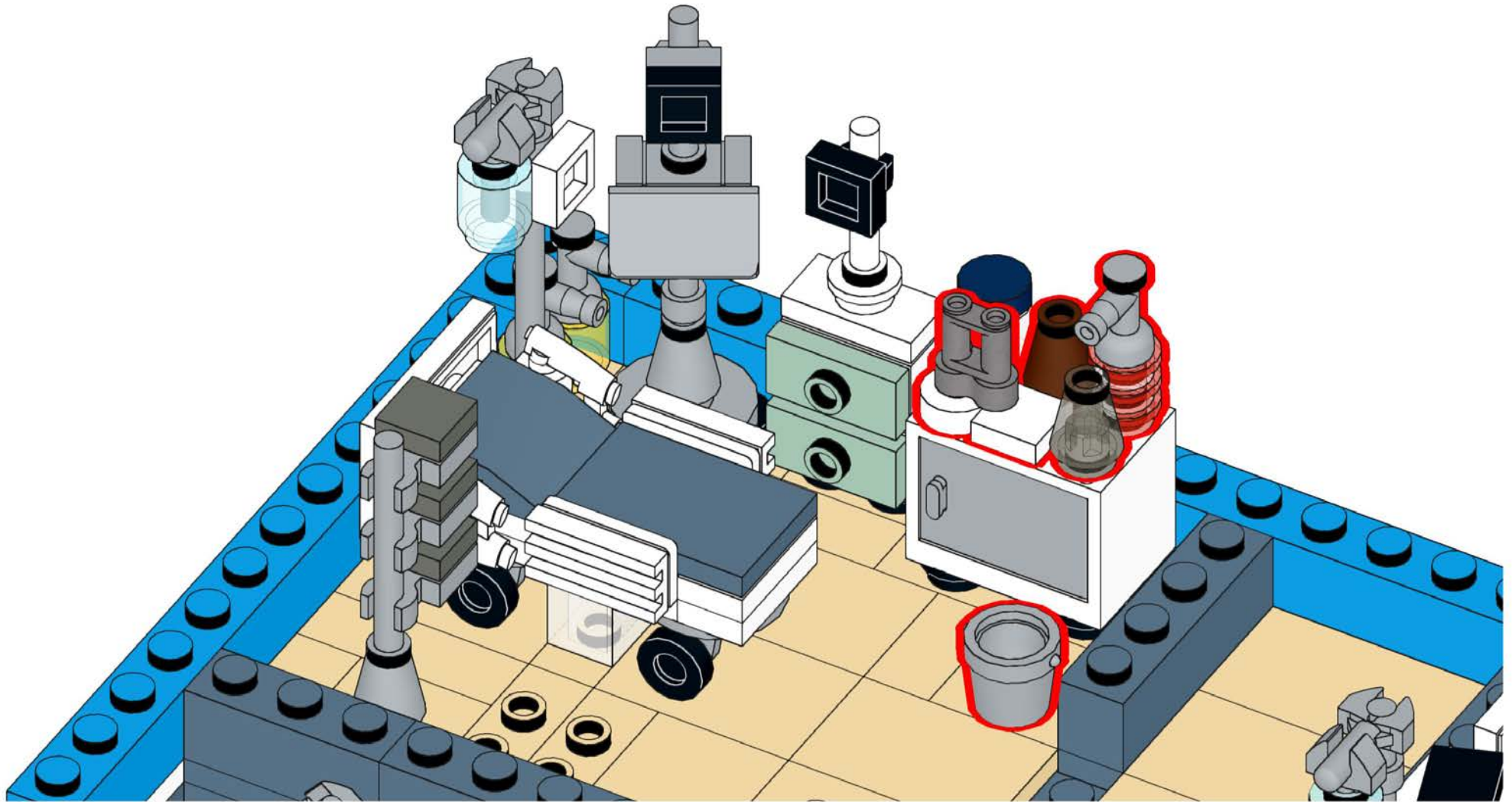

# 405

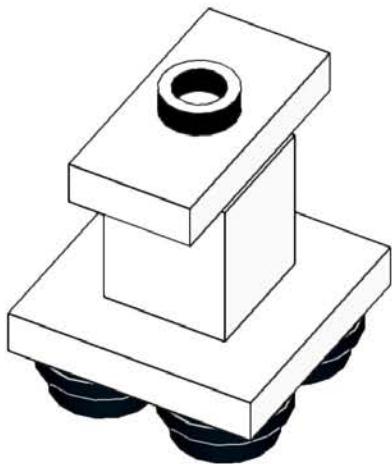
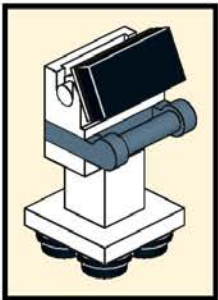
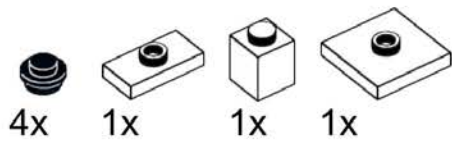

# 406

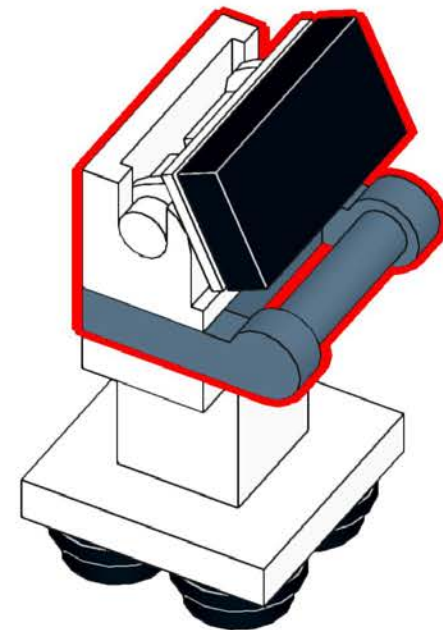
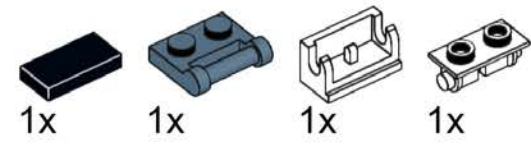

# 407

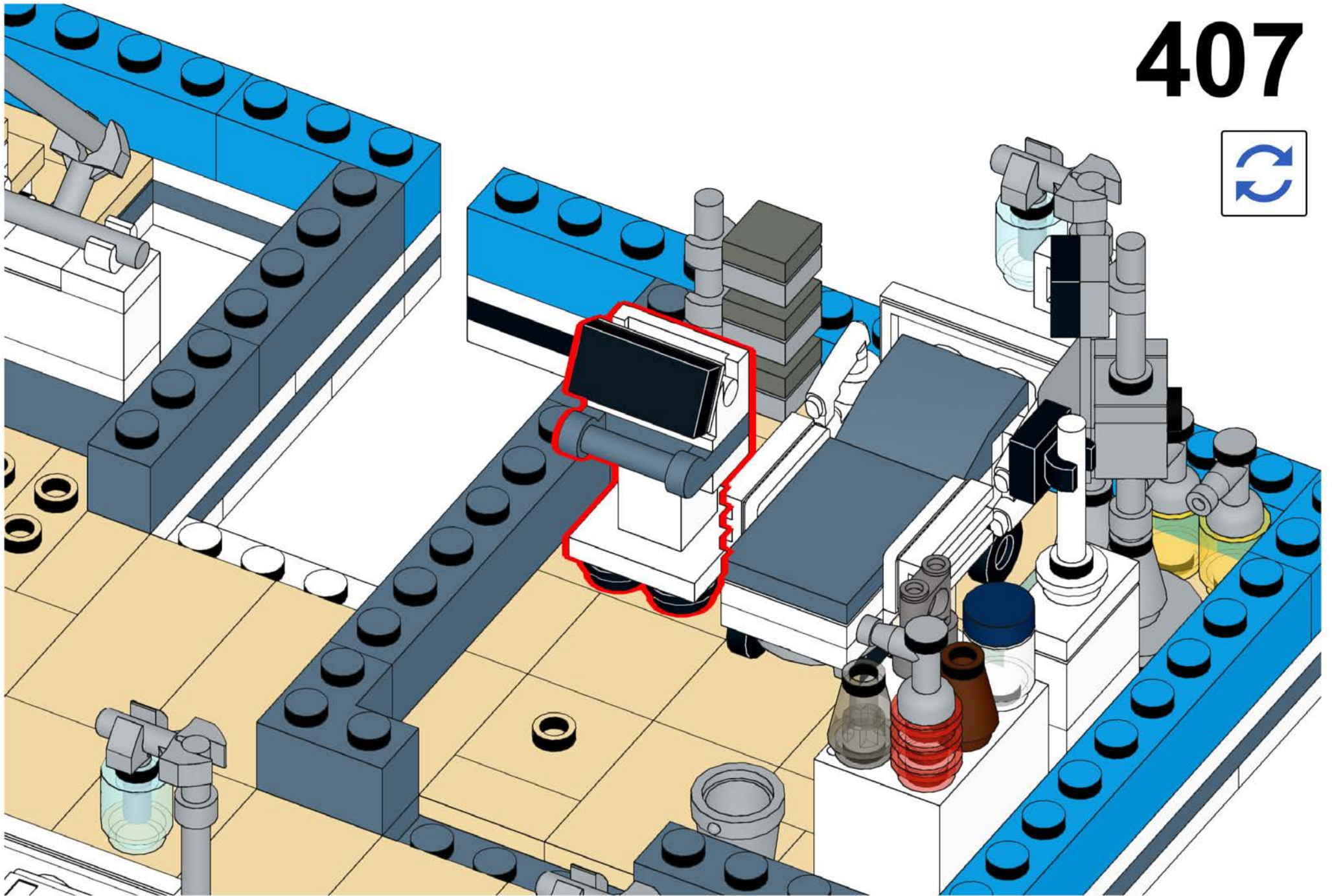

# 408

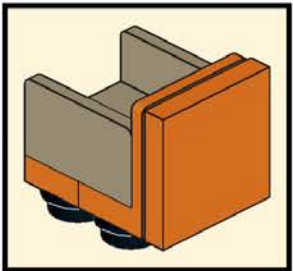
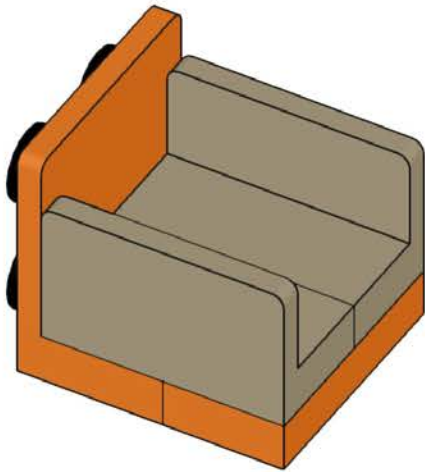
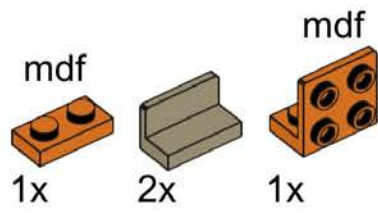

# 409

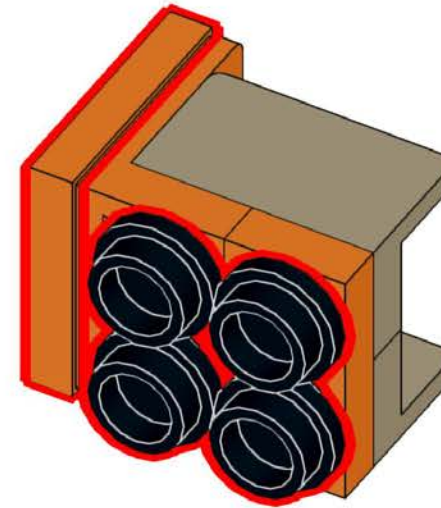
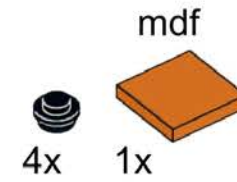

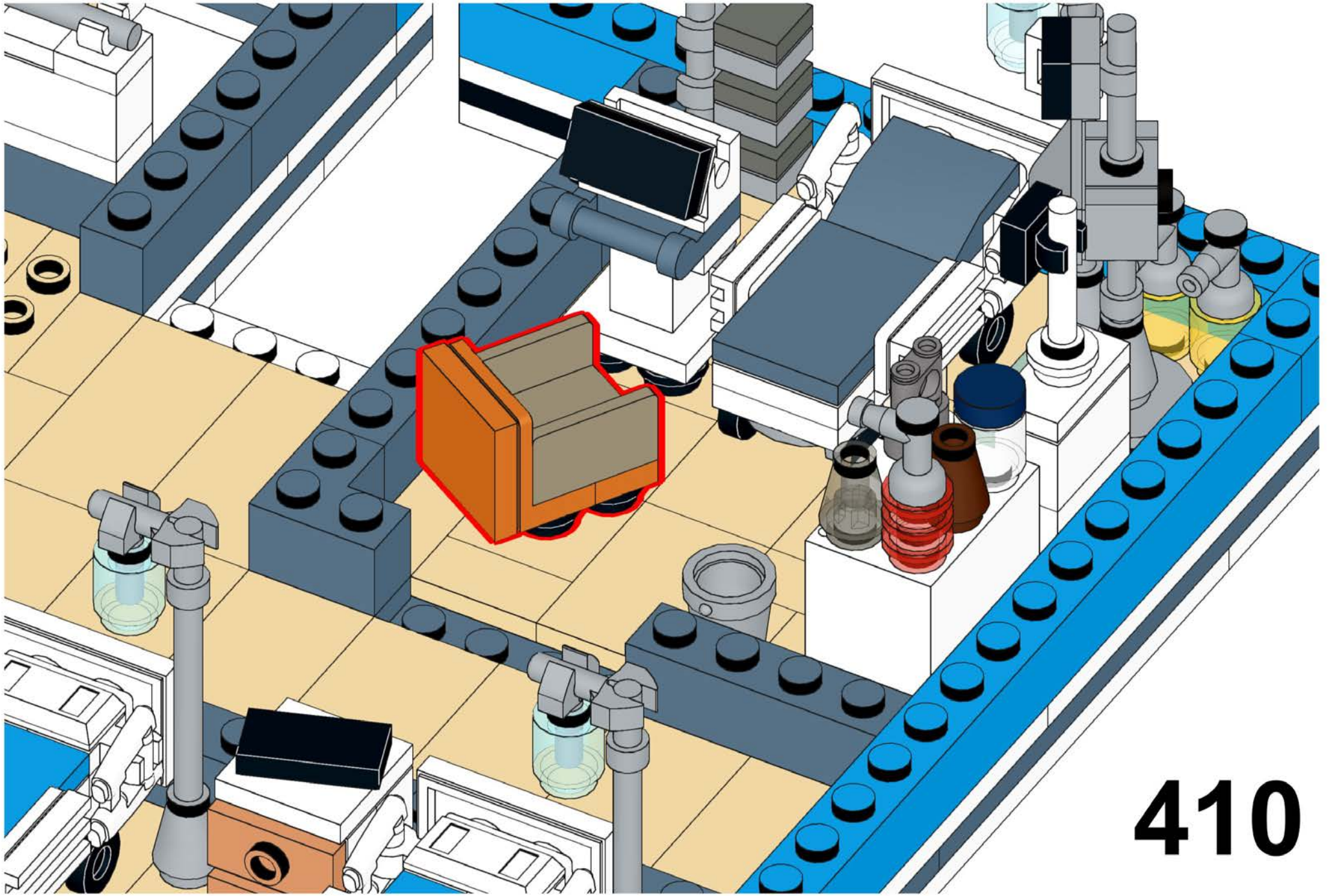

410

# 411

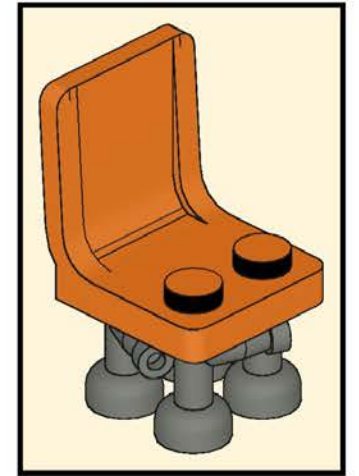
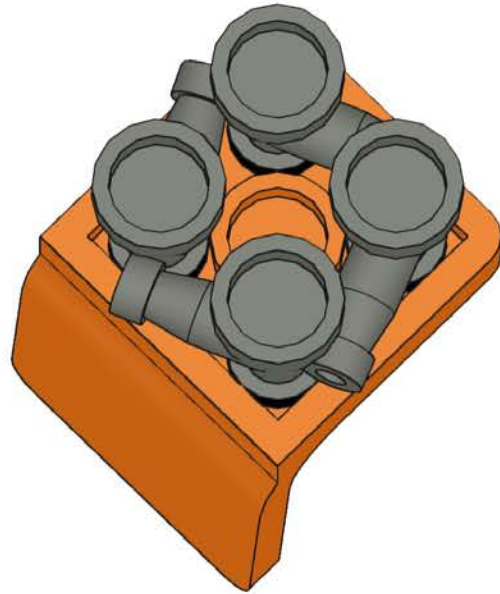
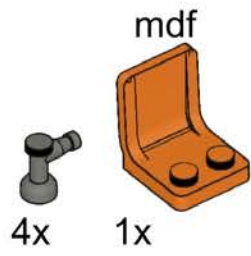

2x



# 412

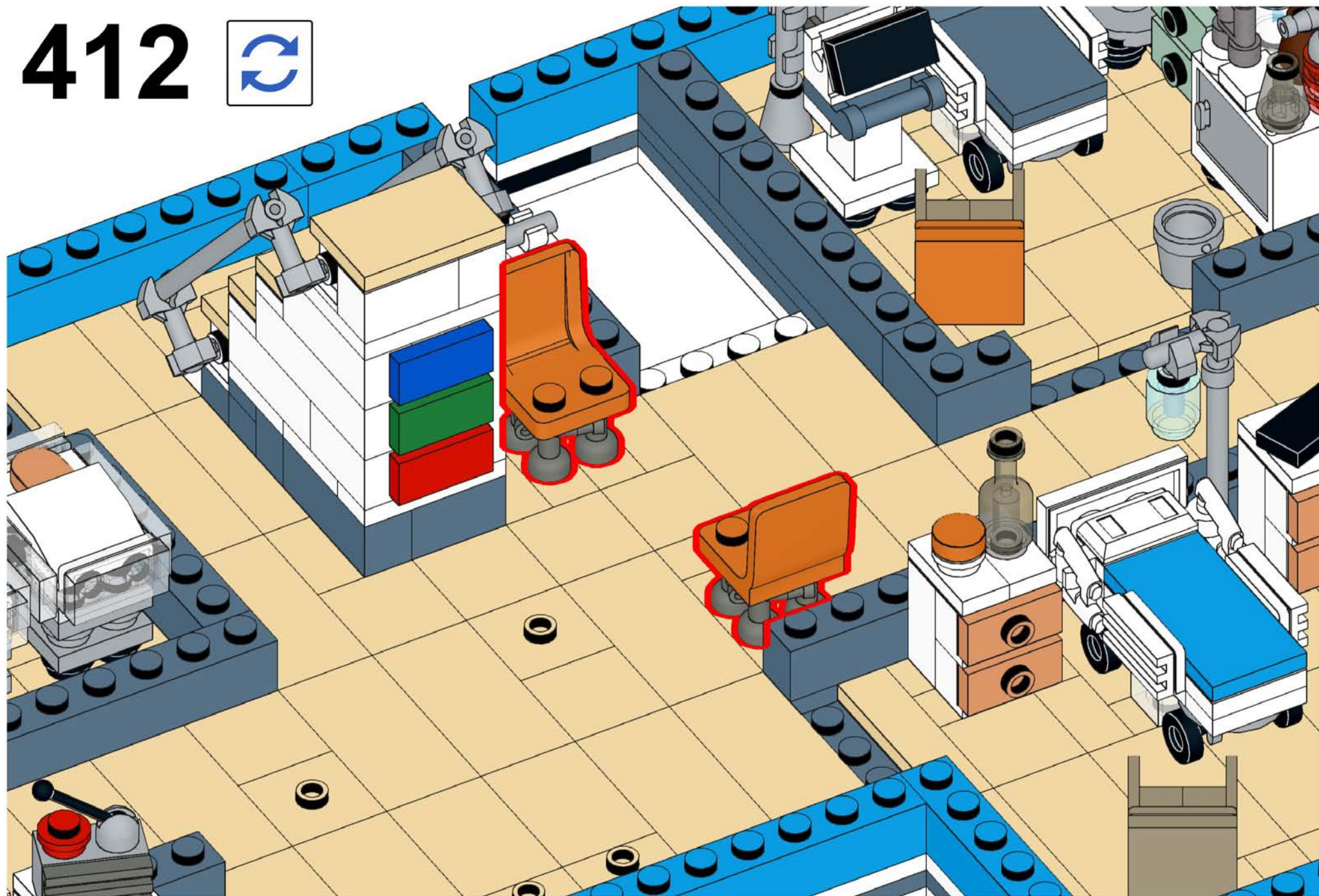

# 413

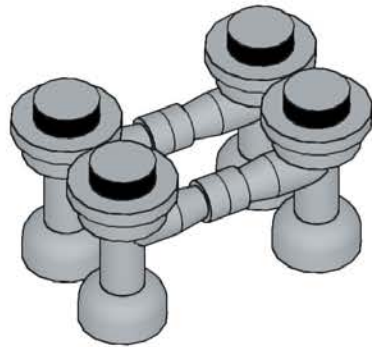
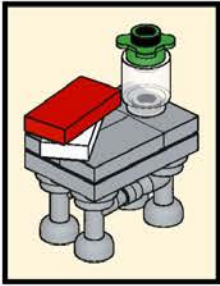

# 414

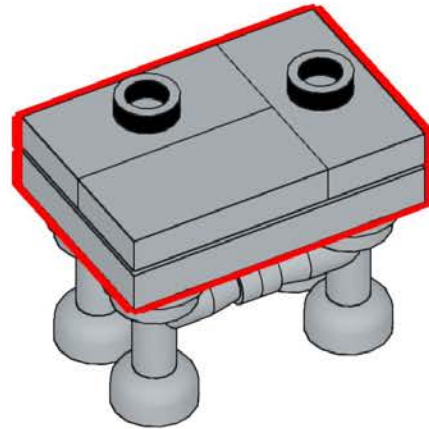
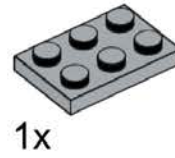
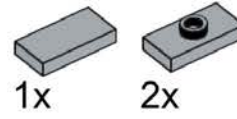

# 415

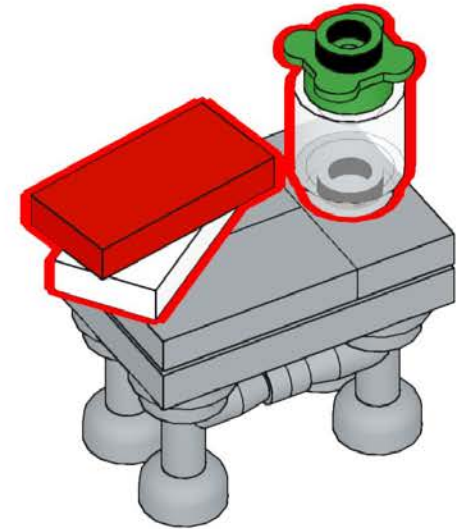
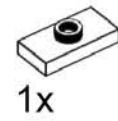
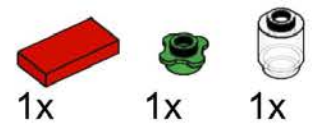

# 416

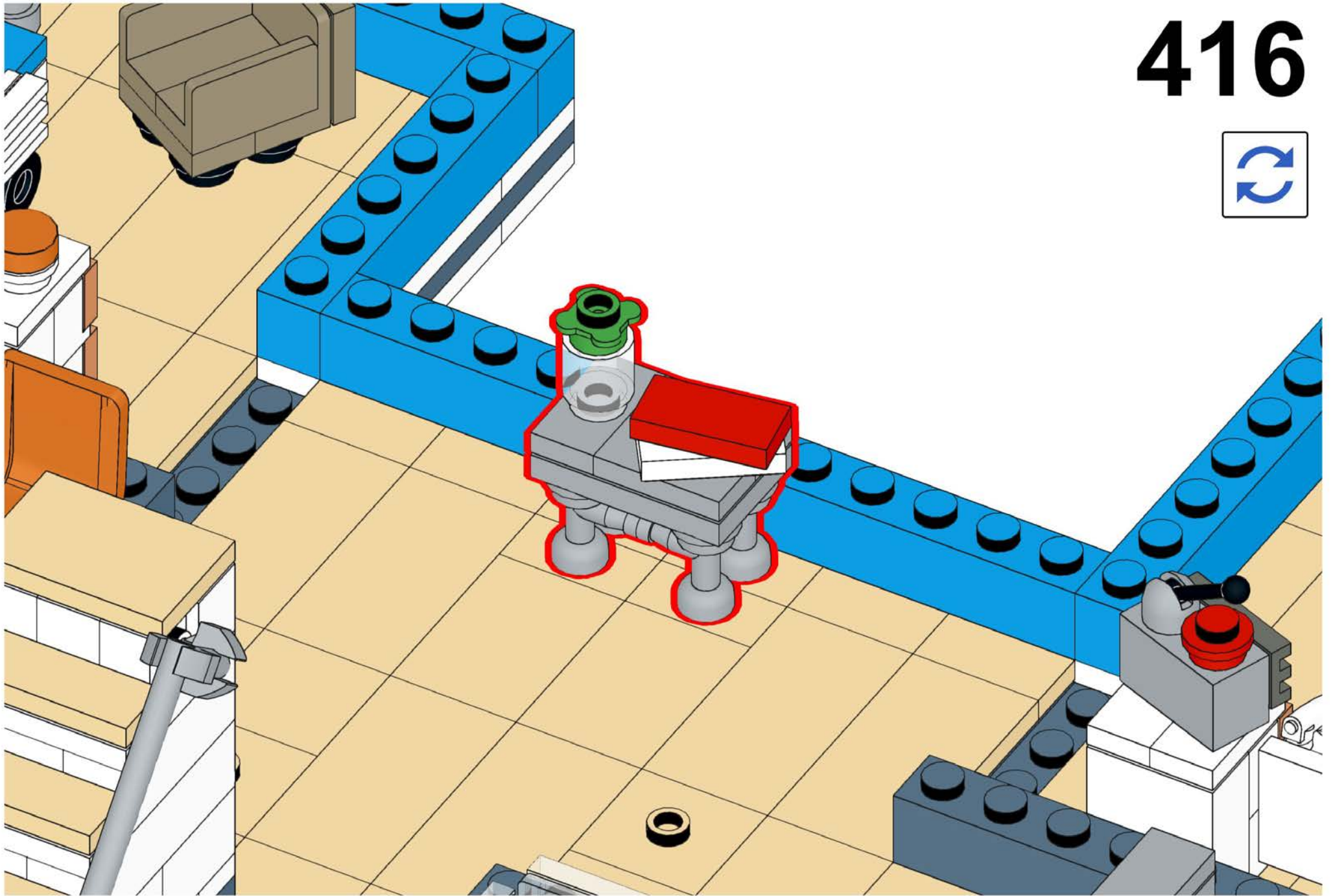

# 417

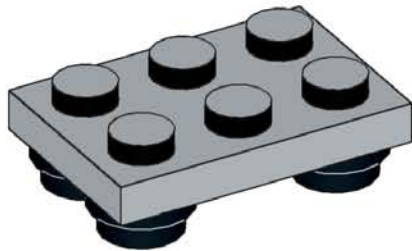
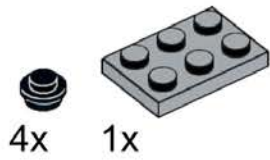

# 419

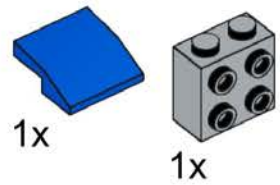
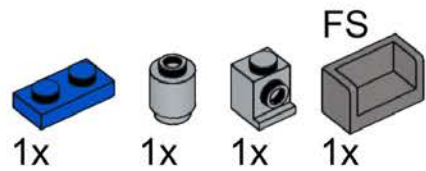
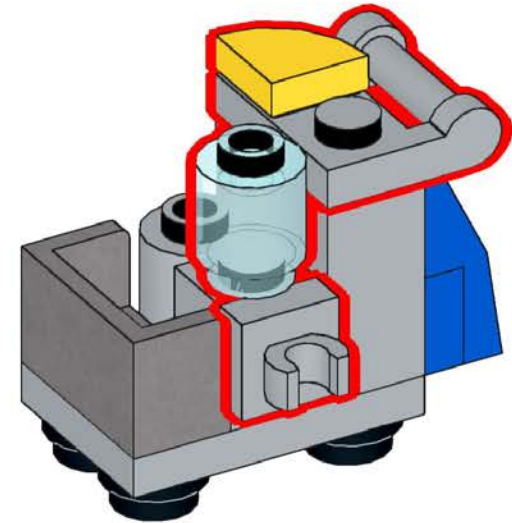

# 418

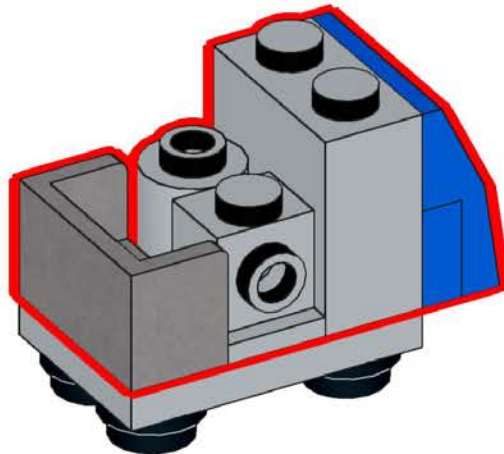

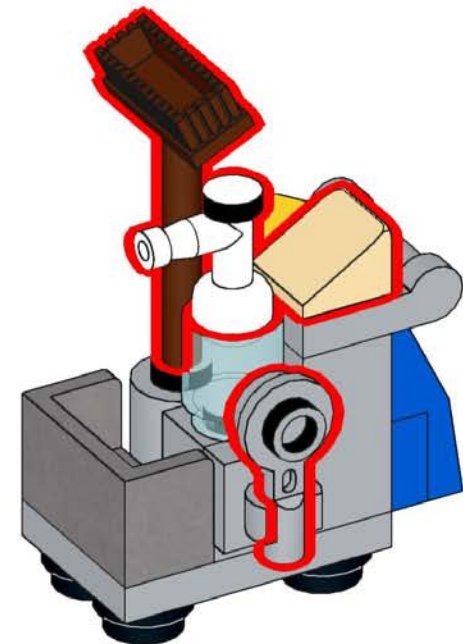
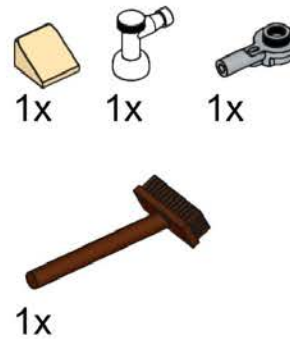

# 420





421



- 1x 
- 1x 

422

# 423

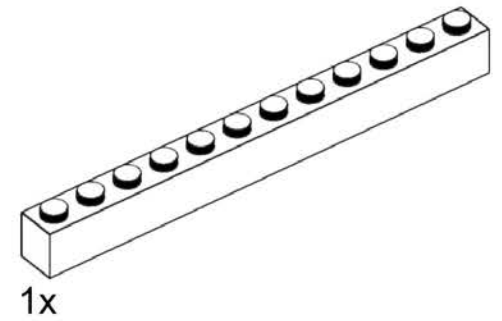
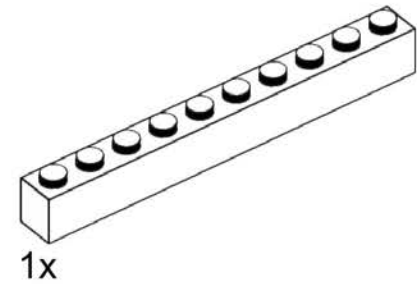
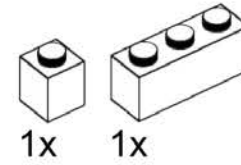
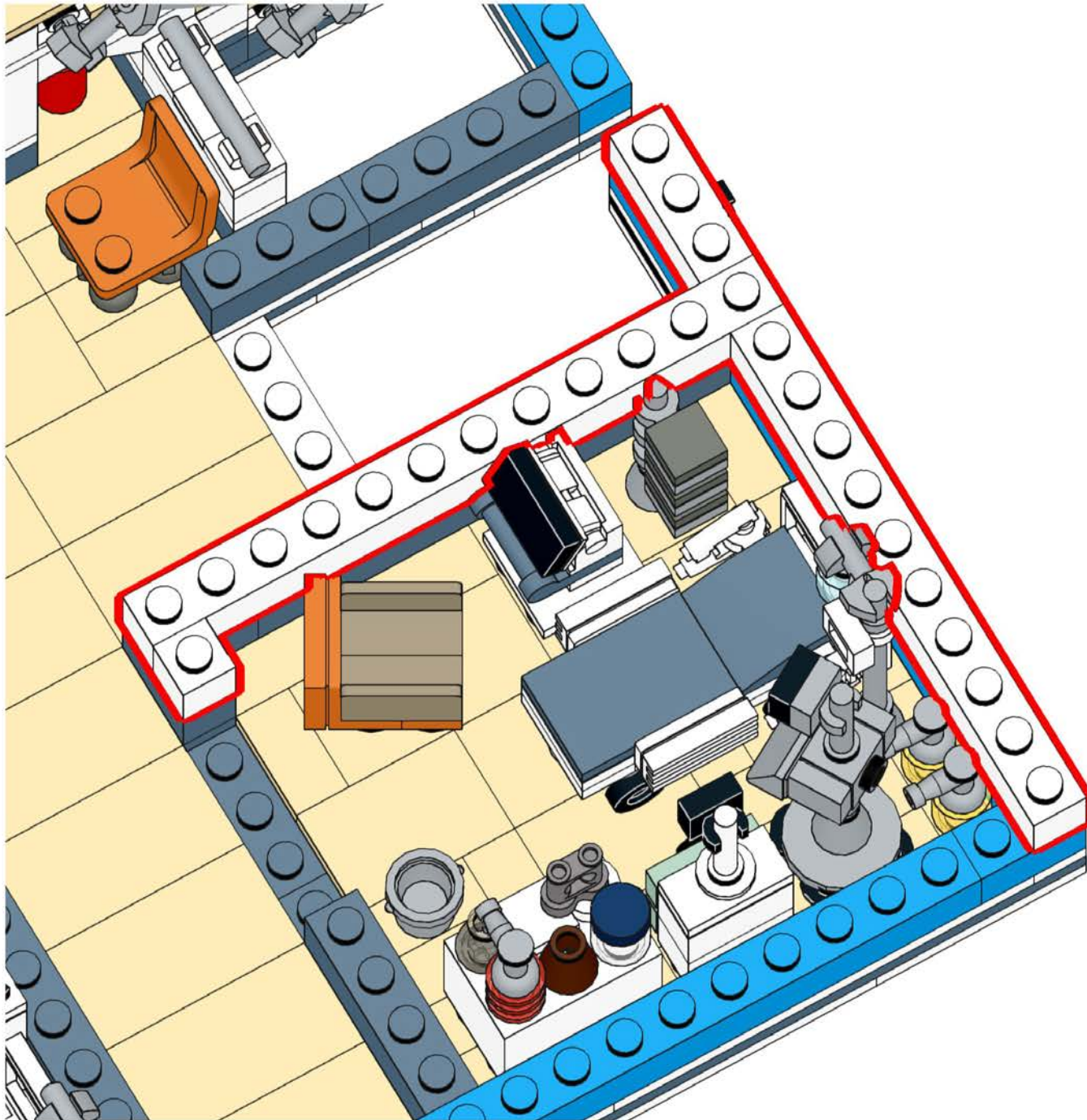

# 424

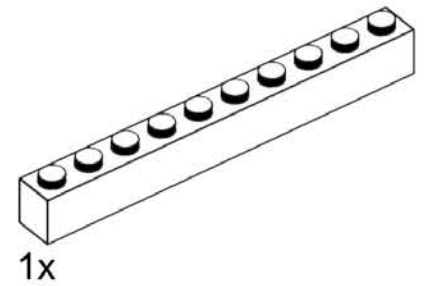
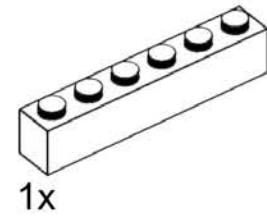
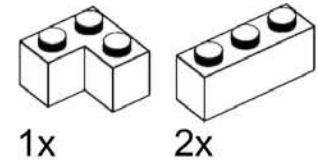
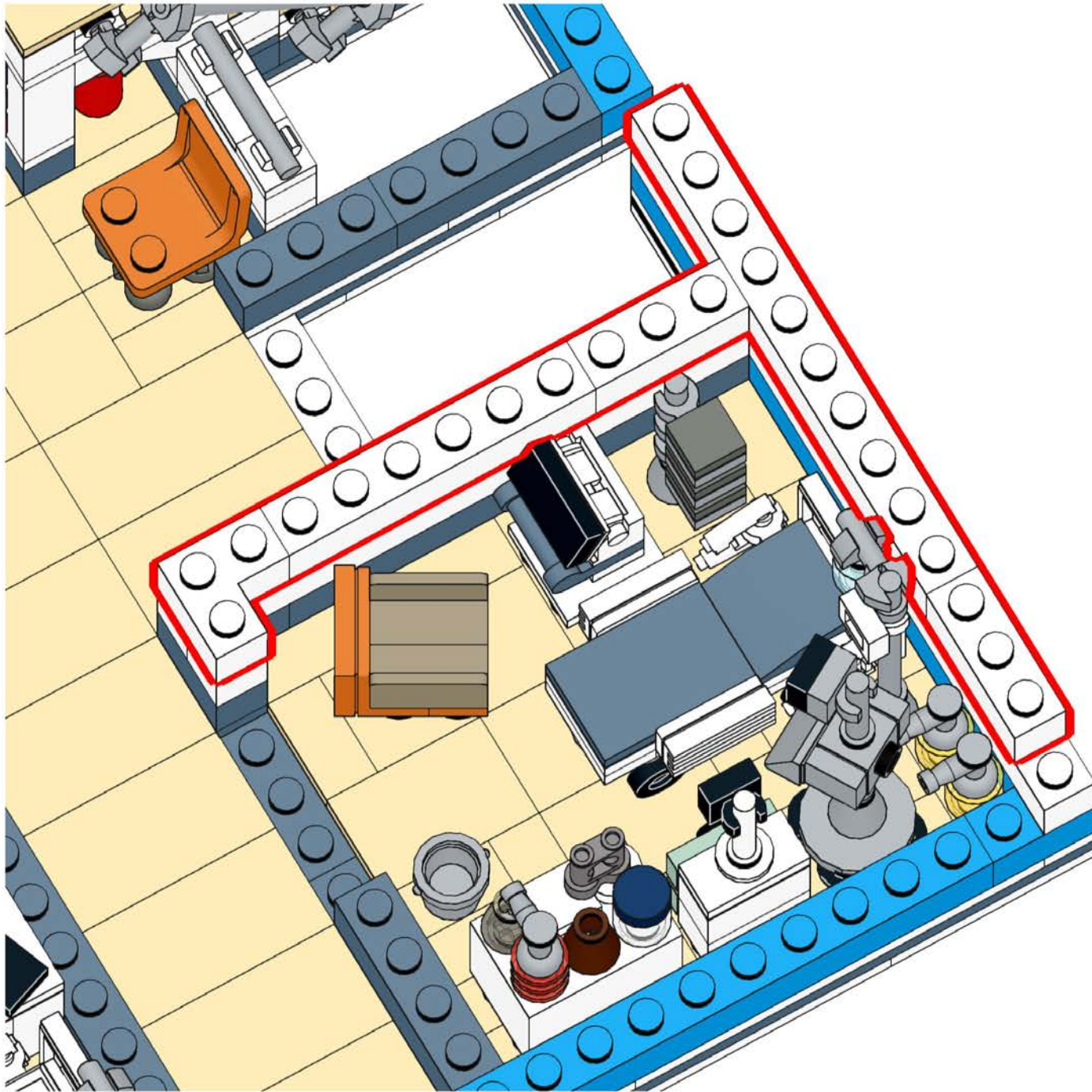



# 425

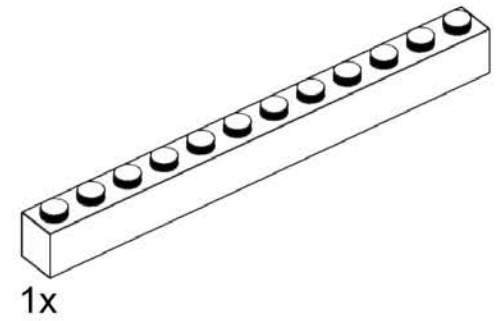
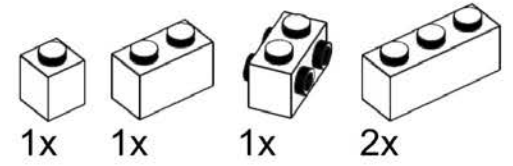
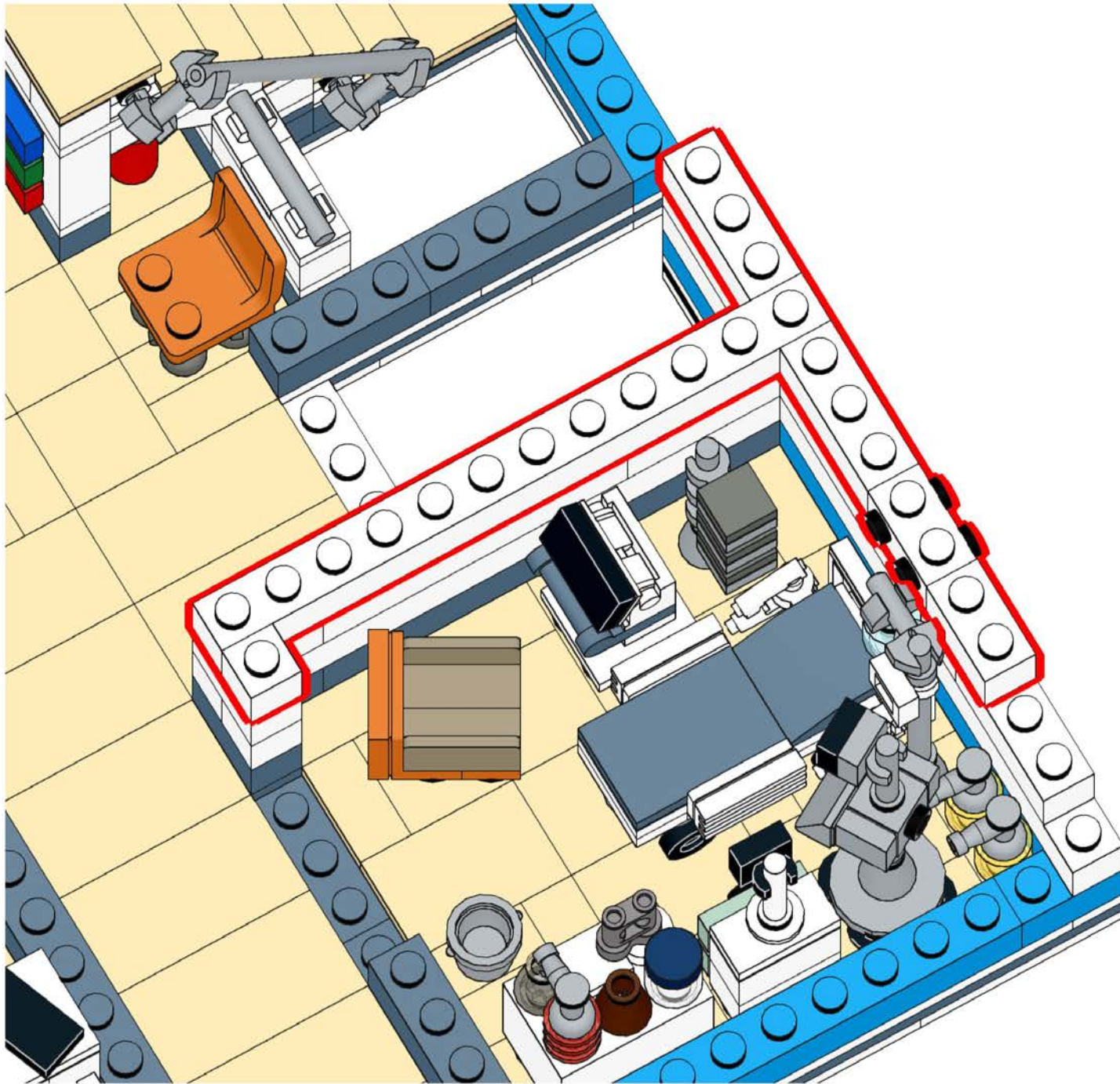

# 426

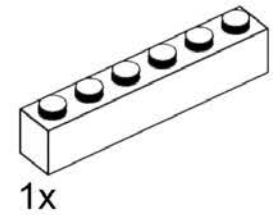
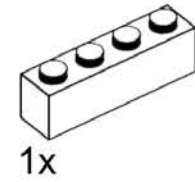
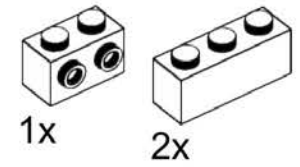
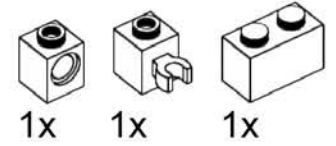
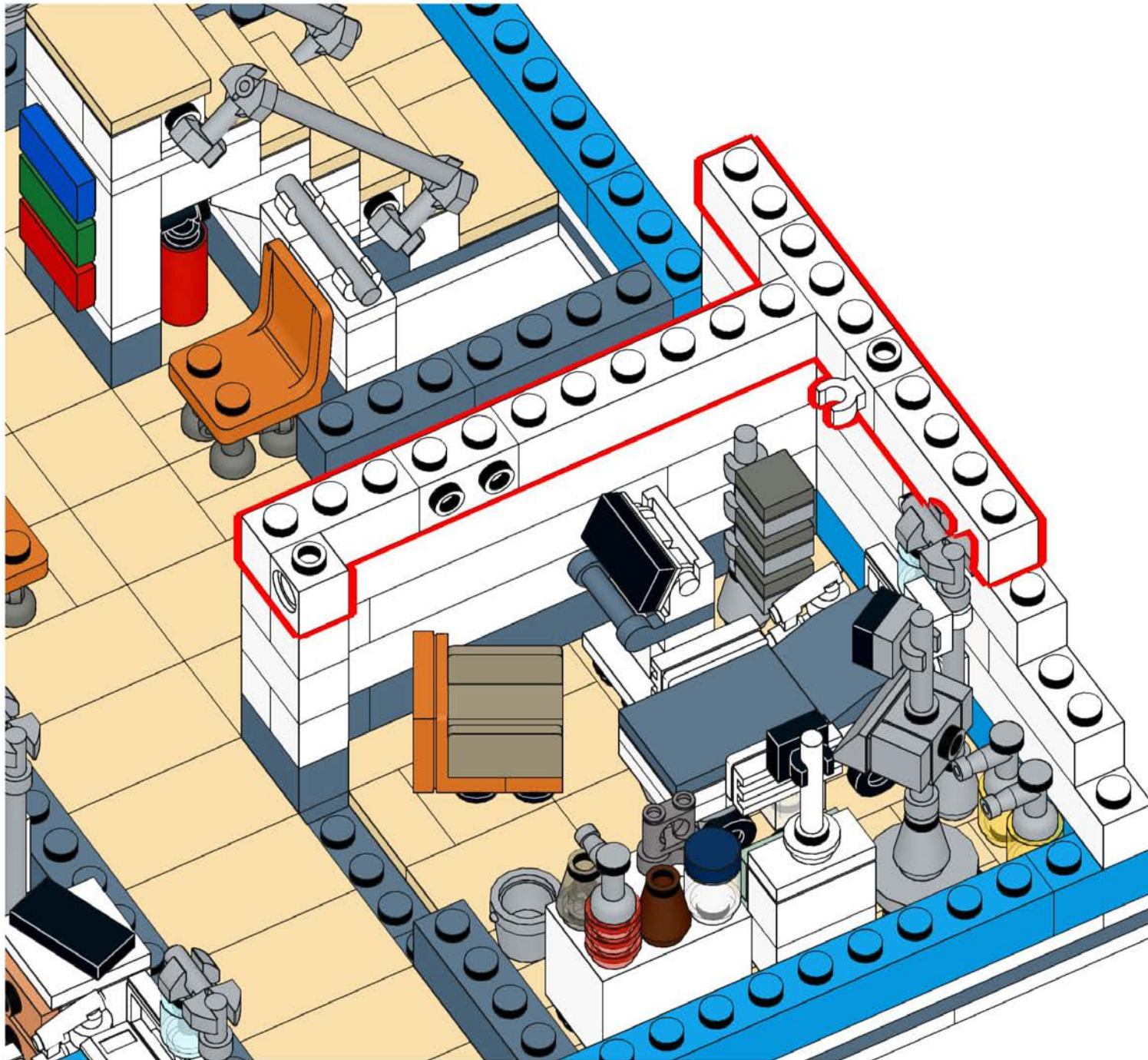

# 427

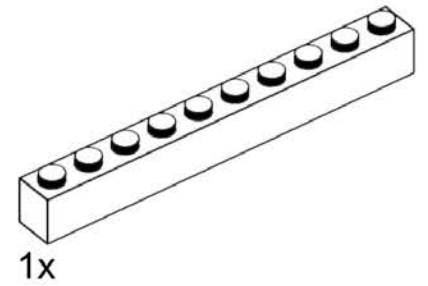
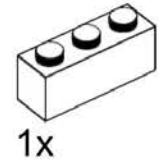
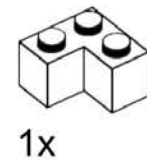
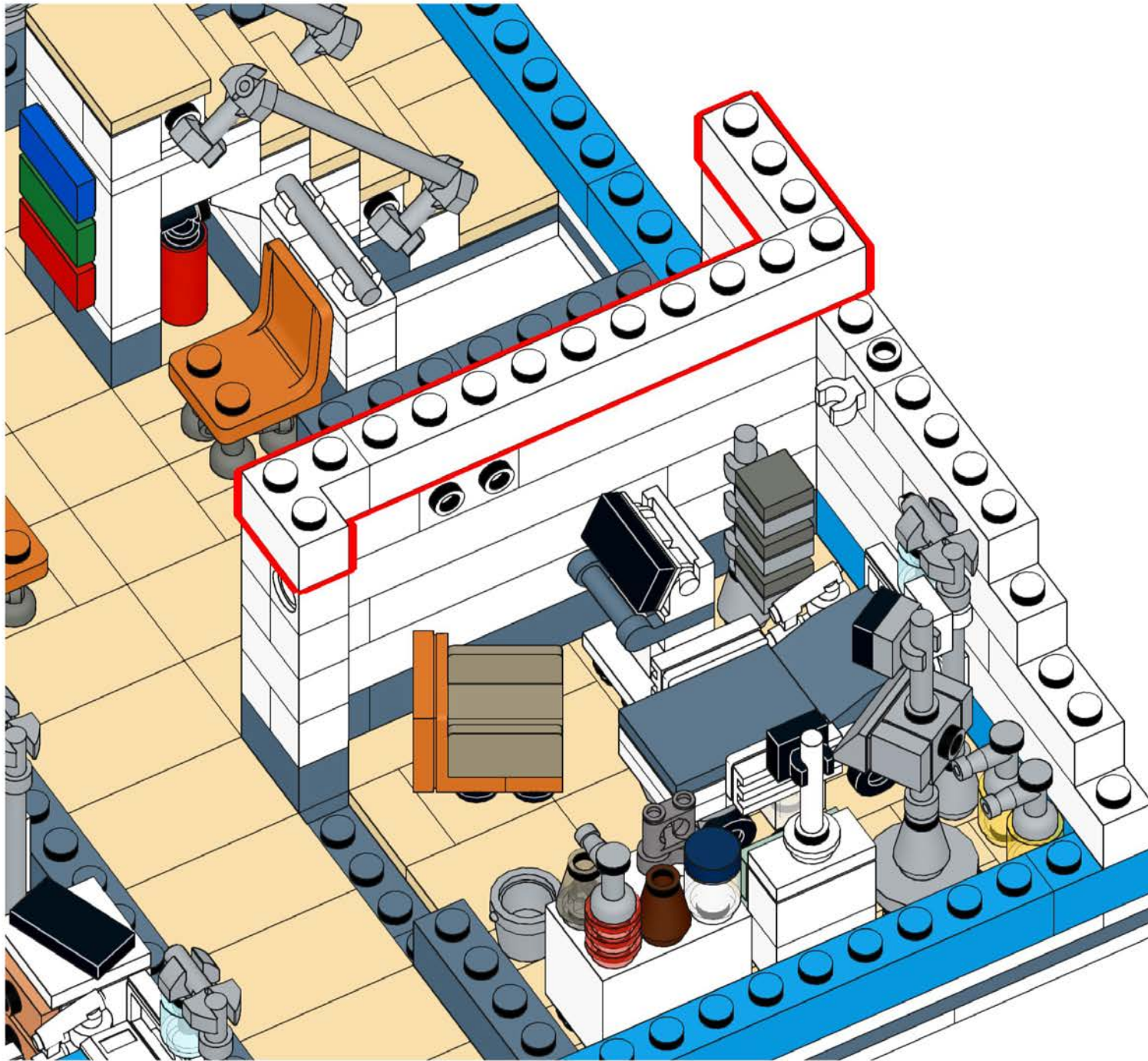

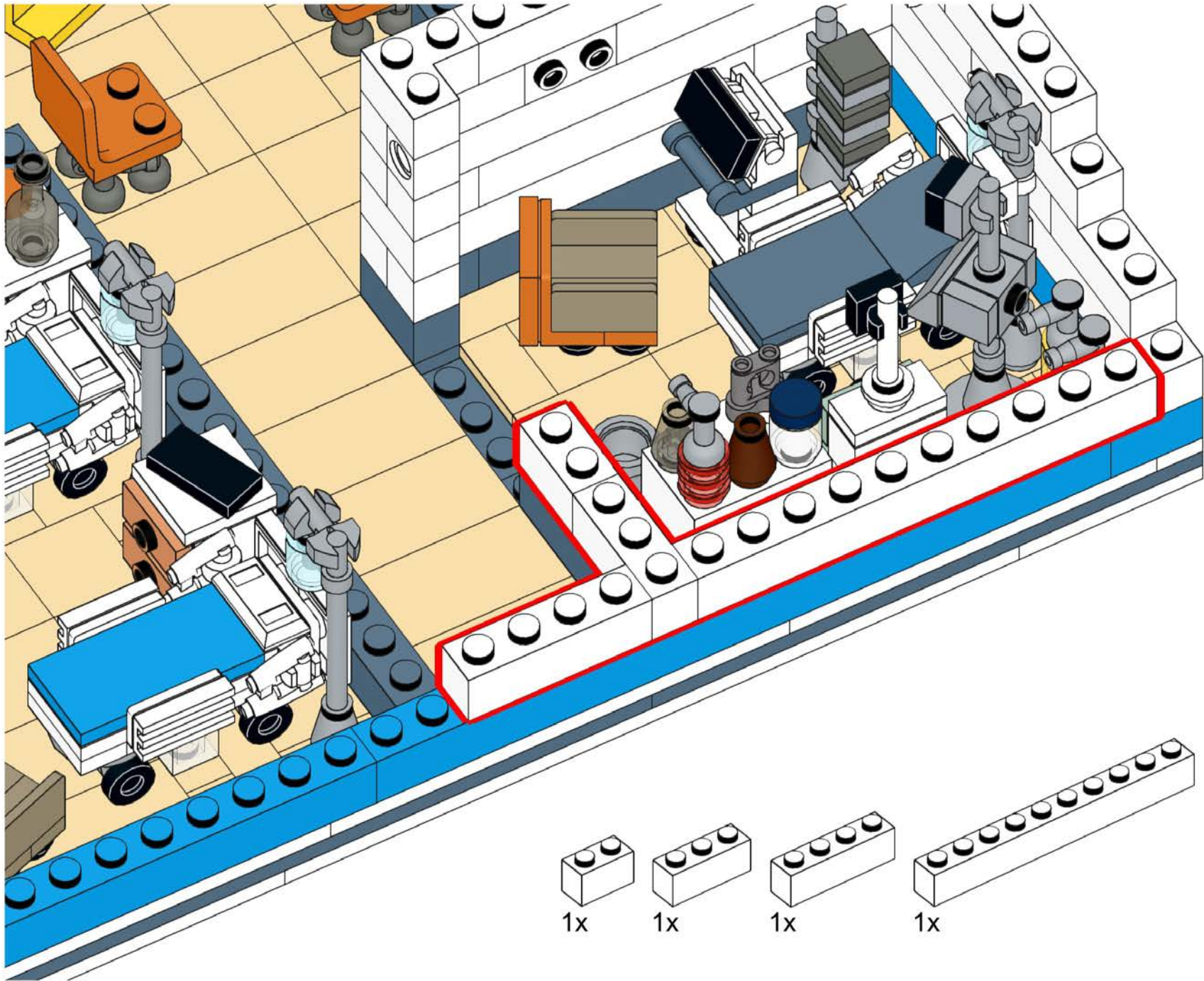

1x

1x

1x

1x

428

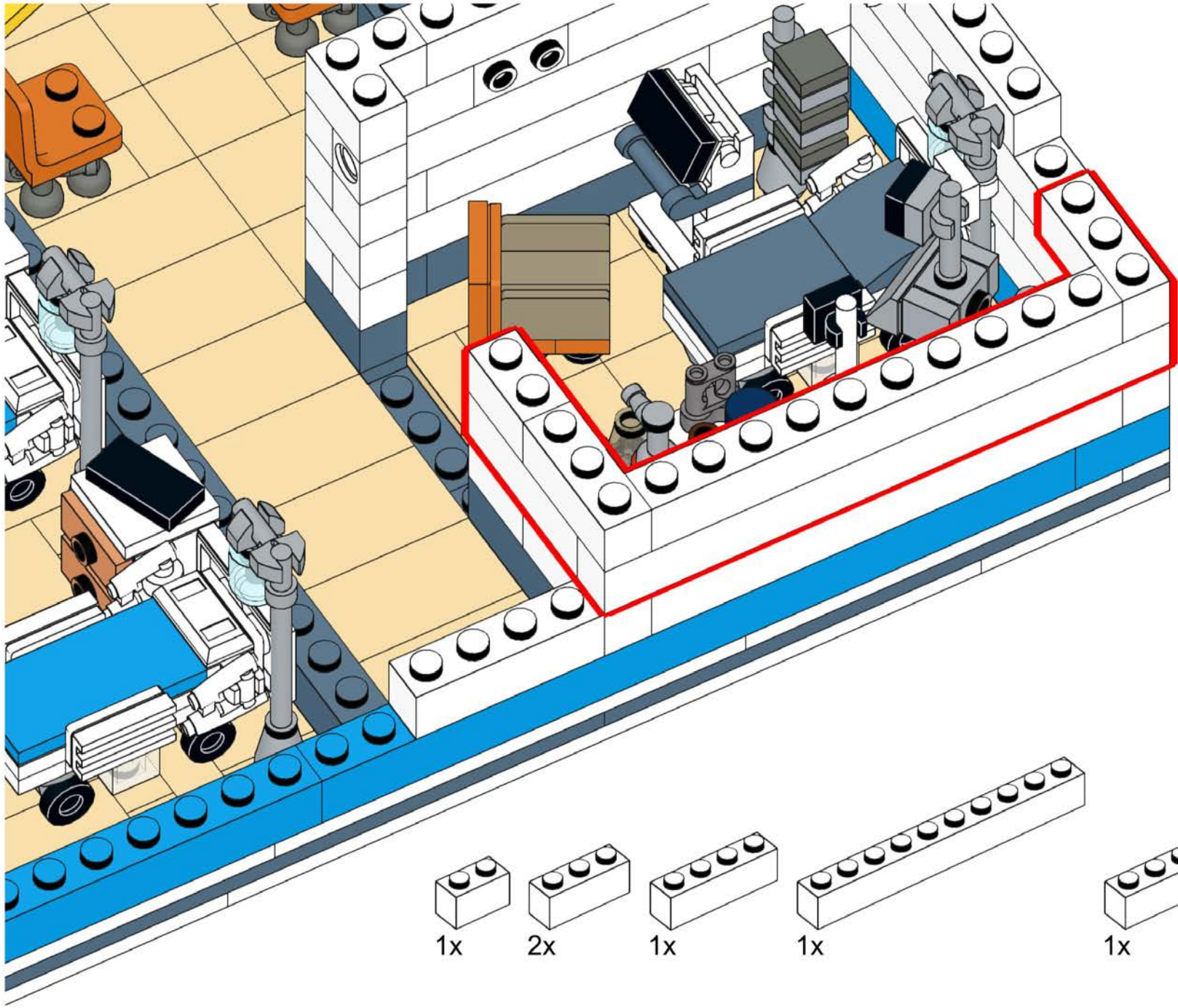

429

- 1x
- 2x
- 1x
- 1x
- 1x

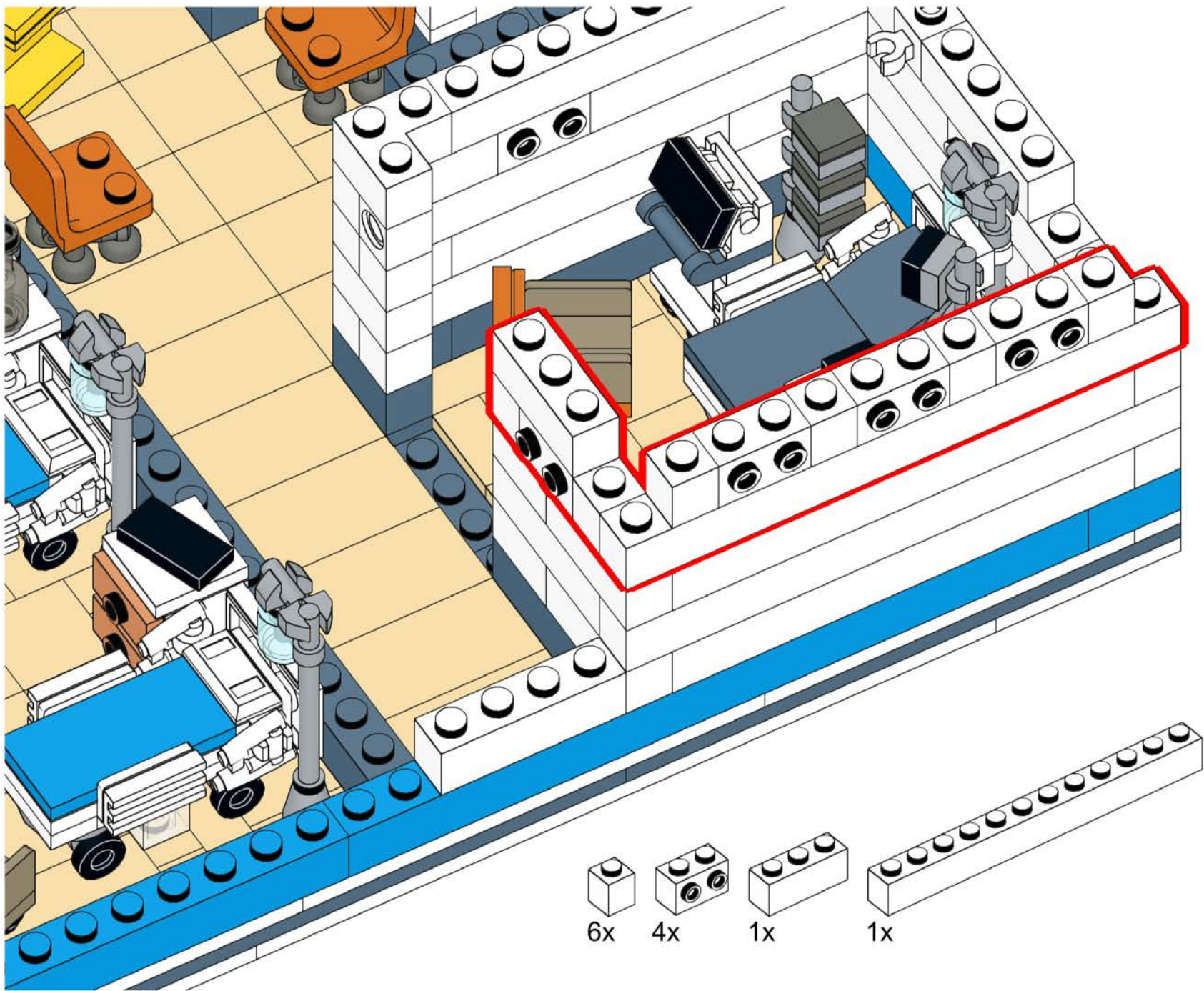

430

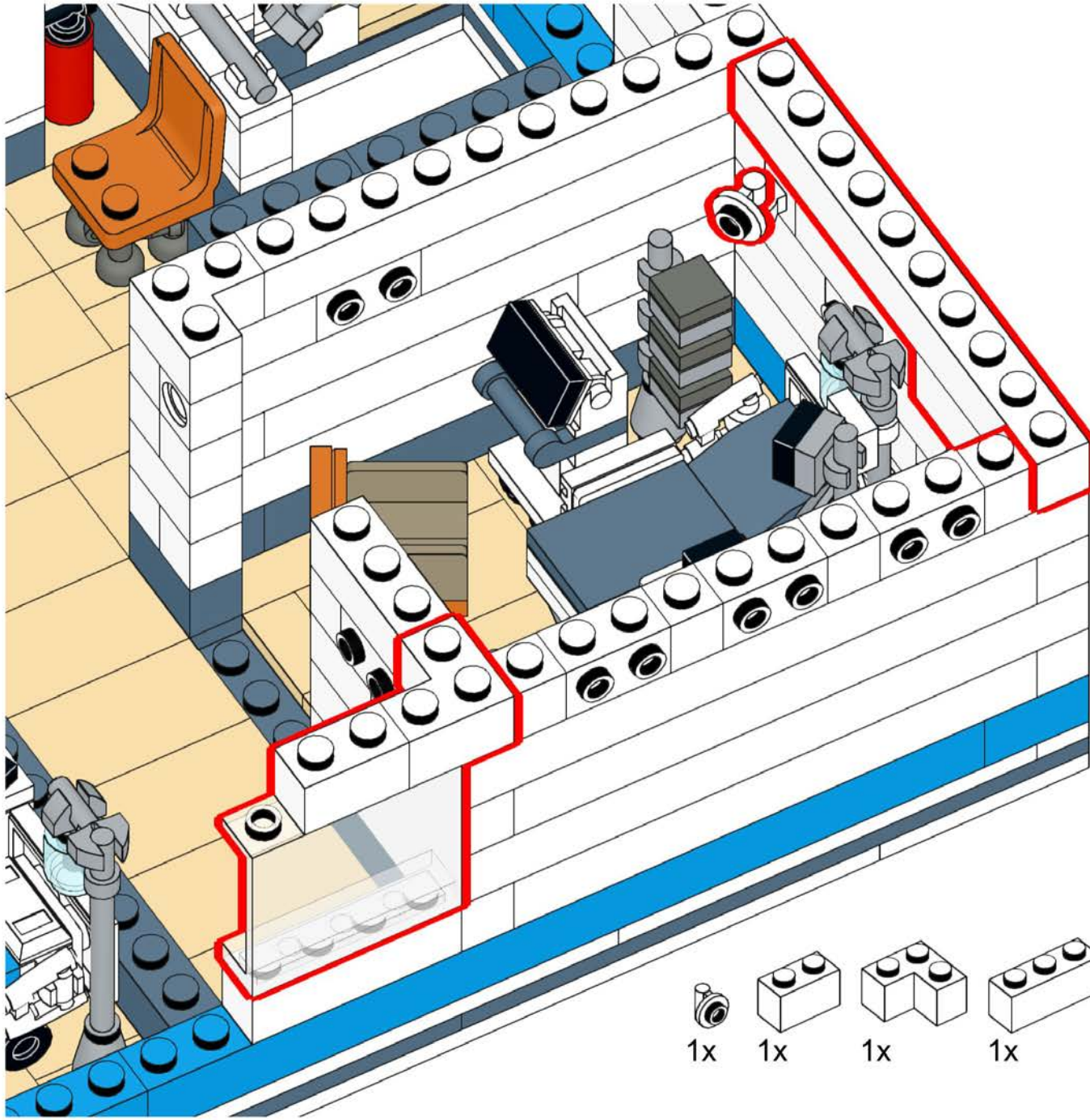

431

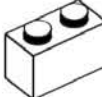
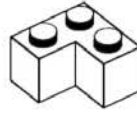
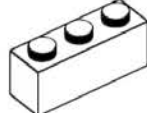
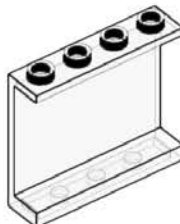
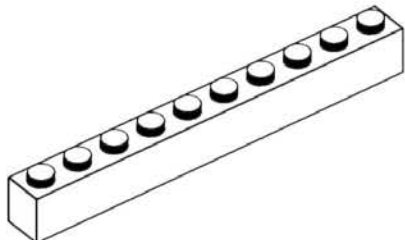
- 1x 
- 1x 
- 1x 
- 1x 
- 1x 
- 1x 

# 432

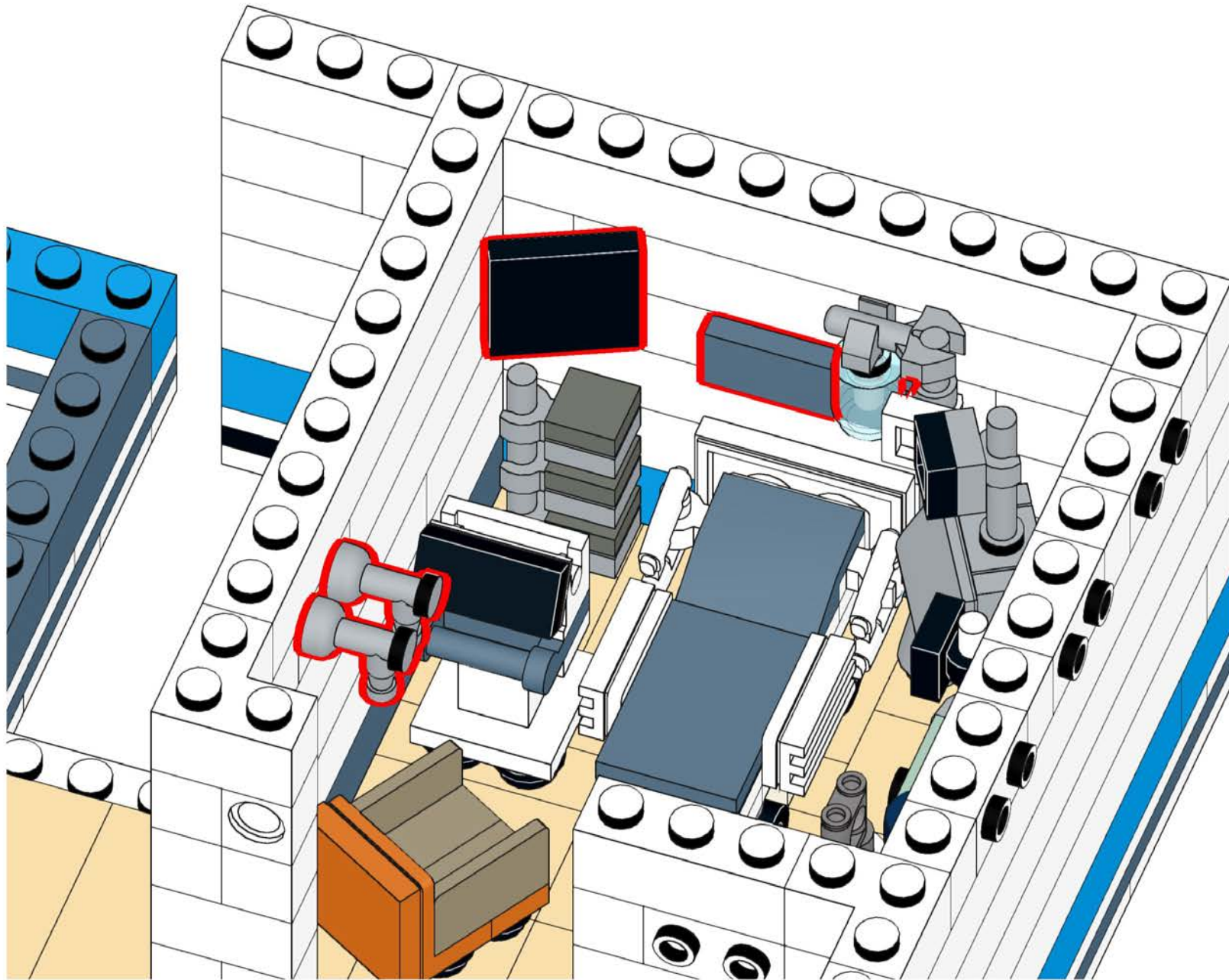

  
2x

  
1x

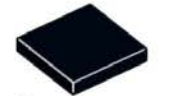
  
1x



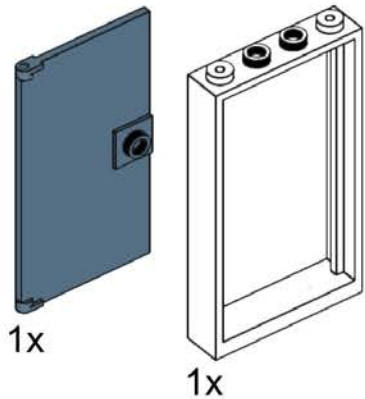
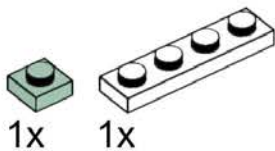
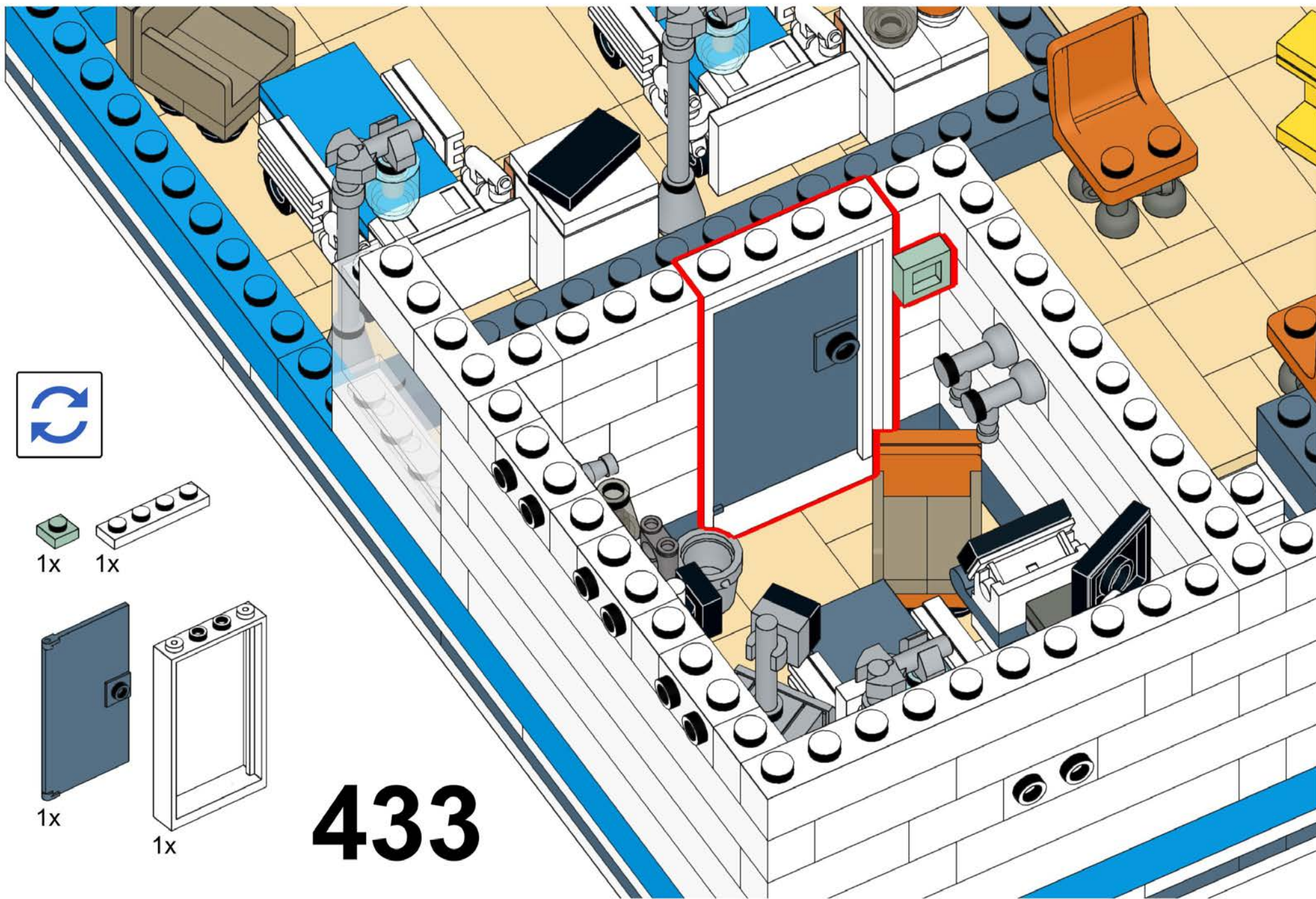

433

# 434

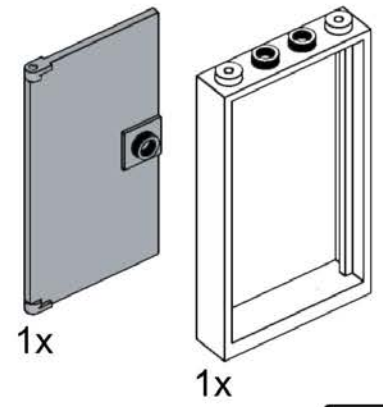
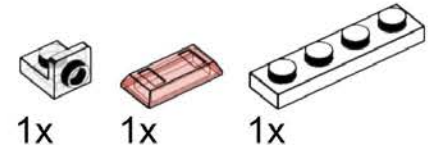
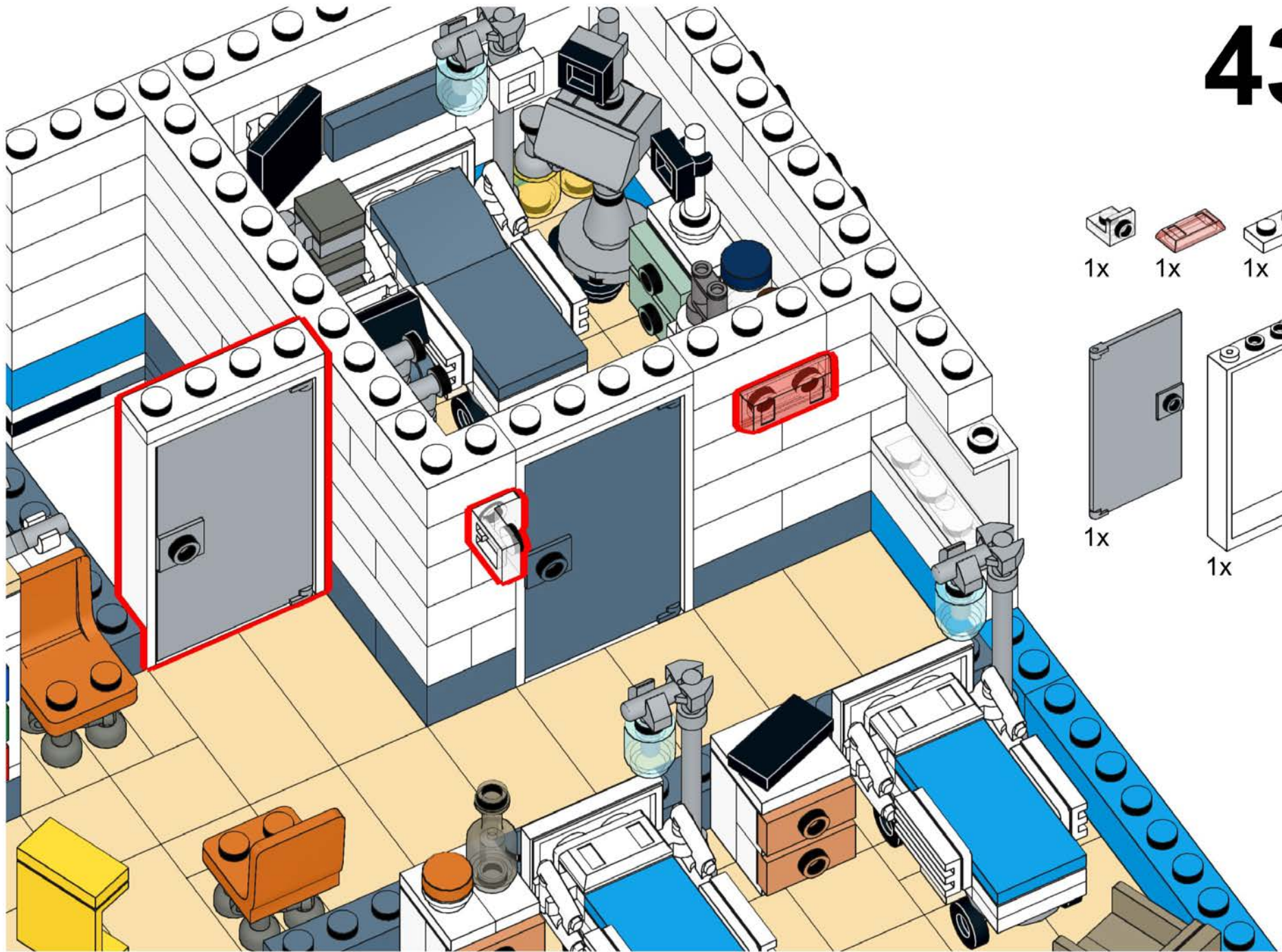

# 435

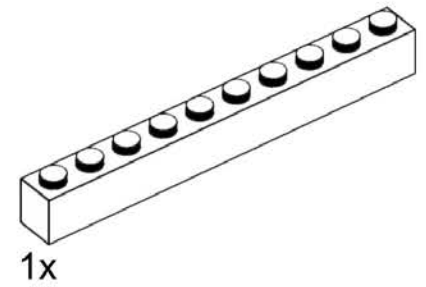
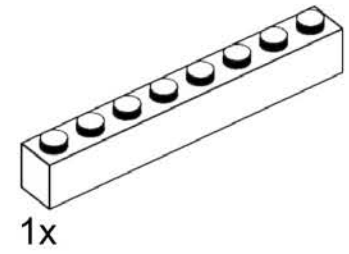
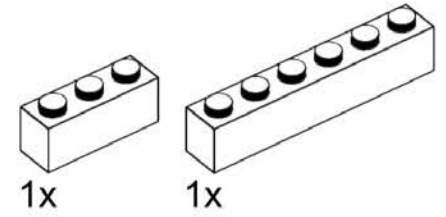

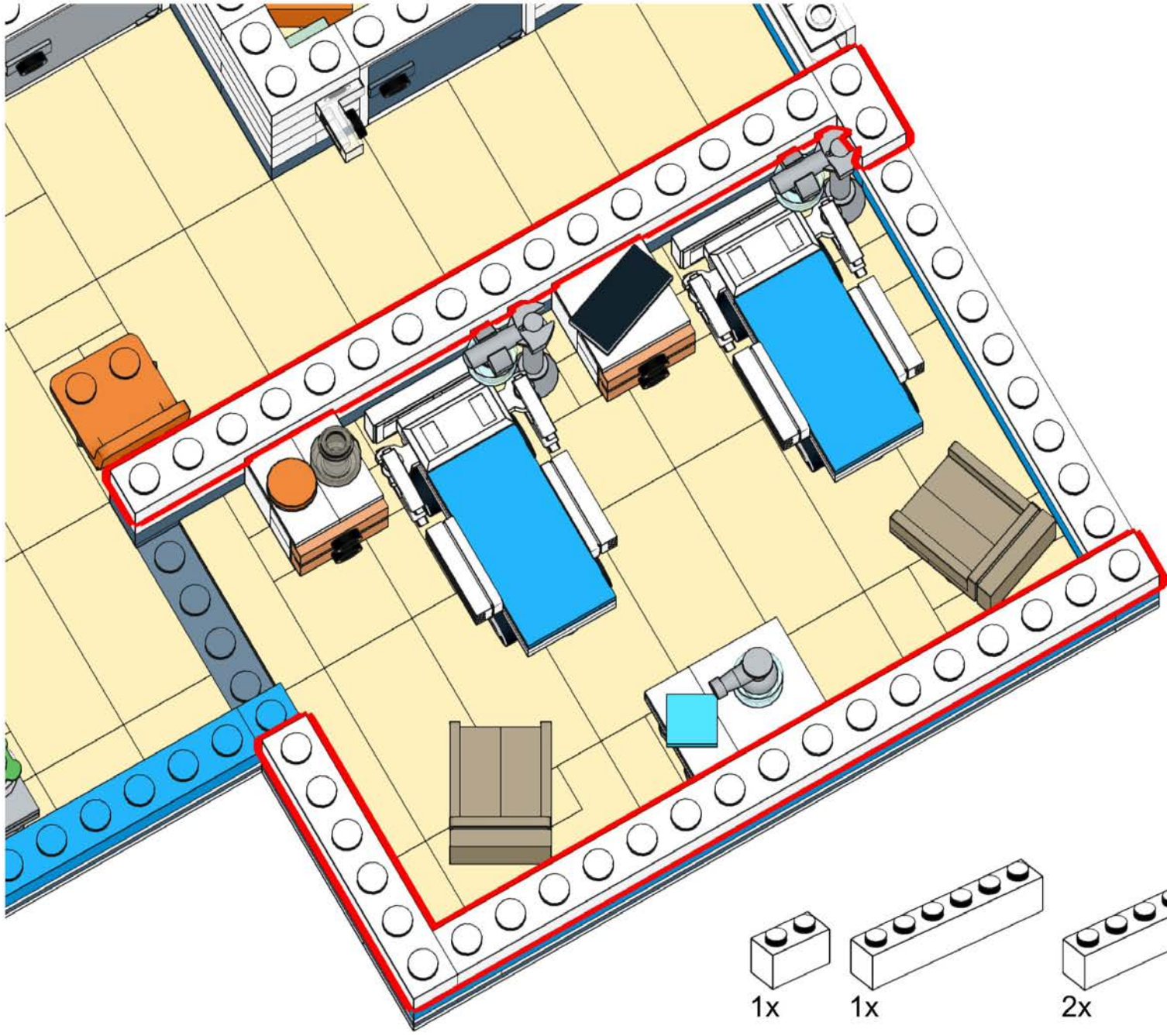

436

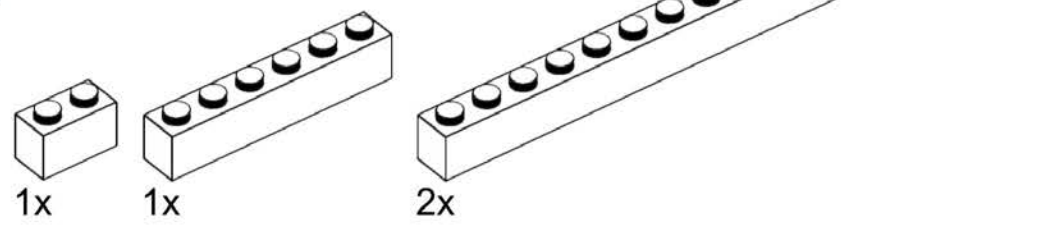

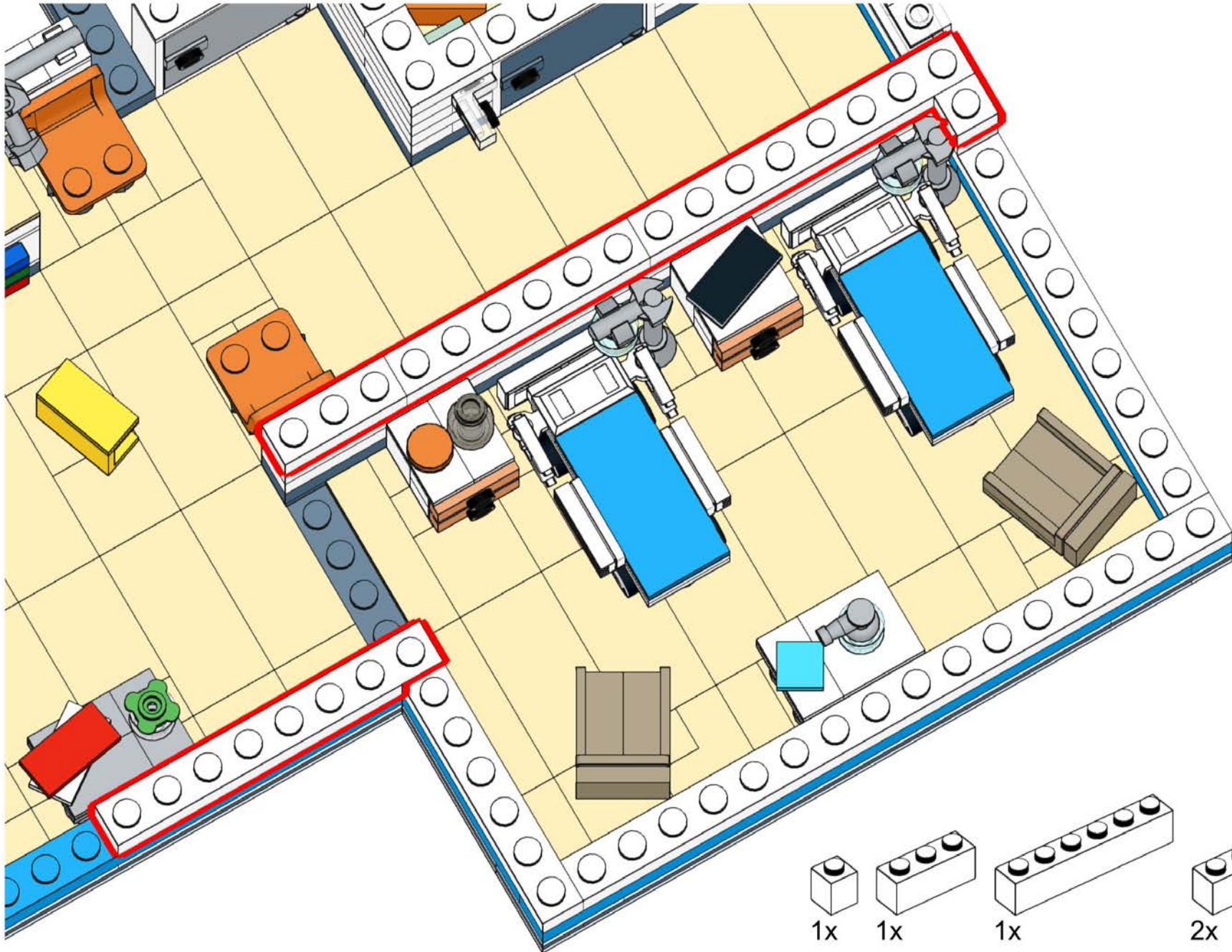

437



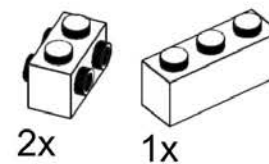
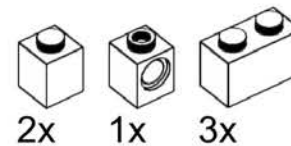
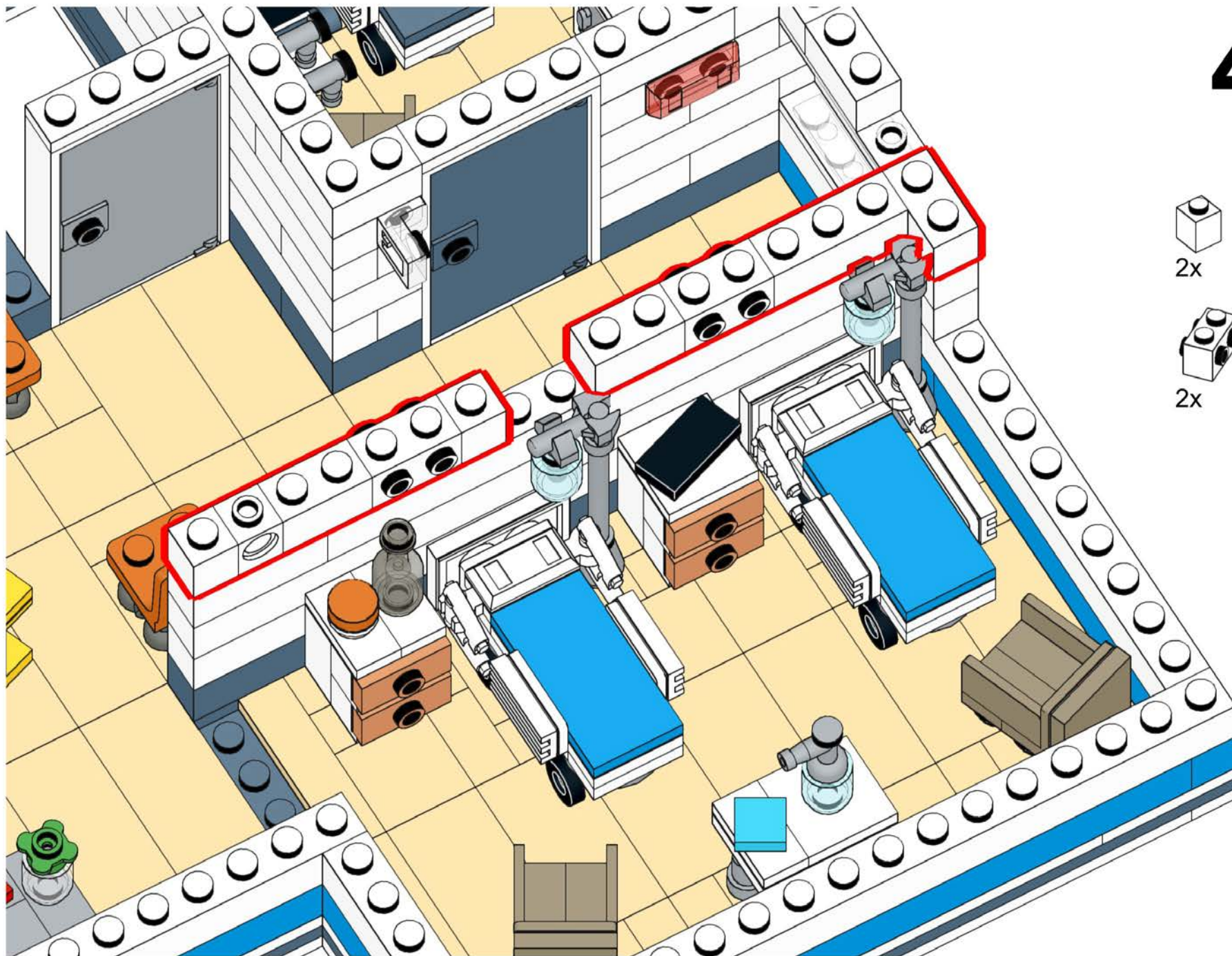

- 1x
- 1x
- 1x
- 2x

# 438



# 439

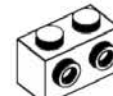

- 1x 
- 2x 
- 1x 
- 2x 

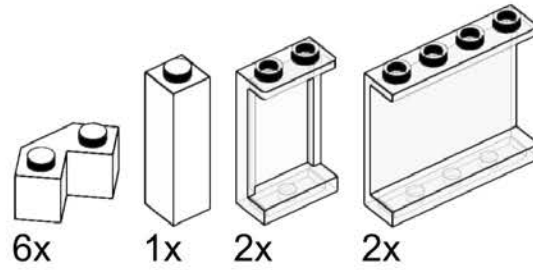
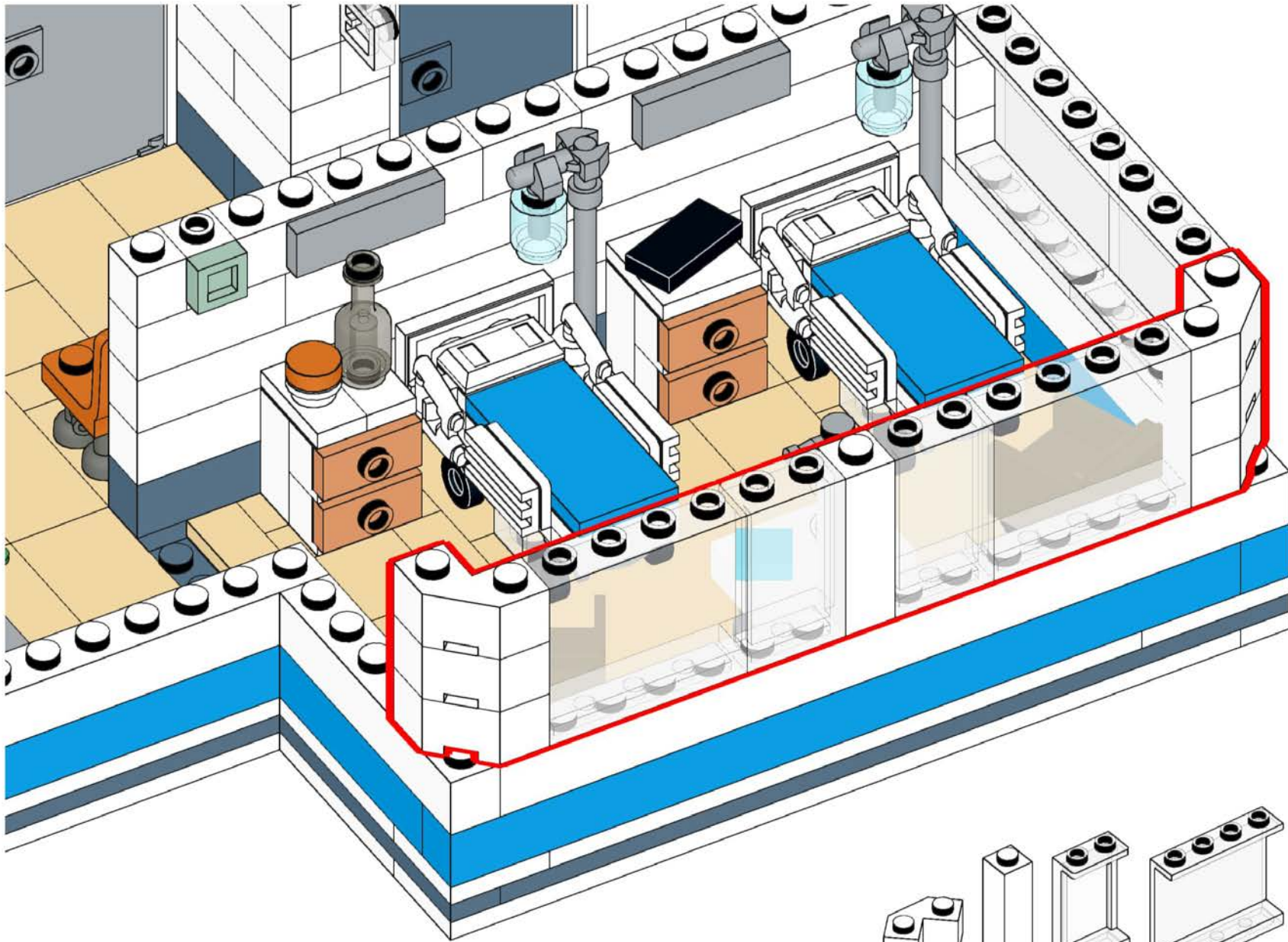

**440**



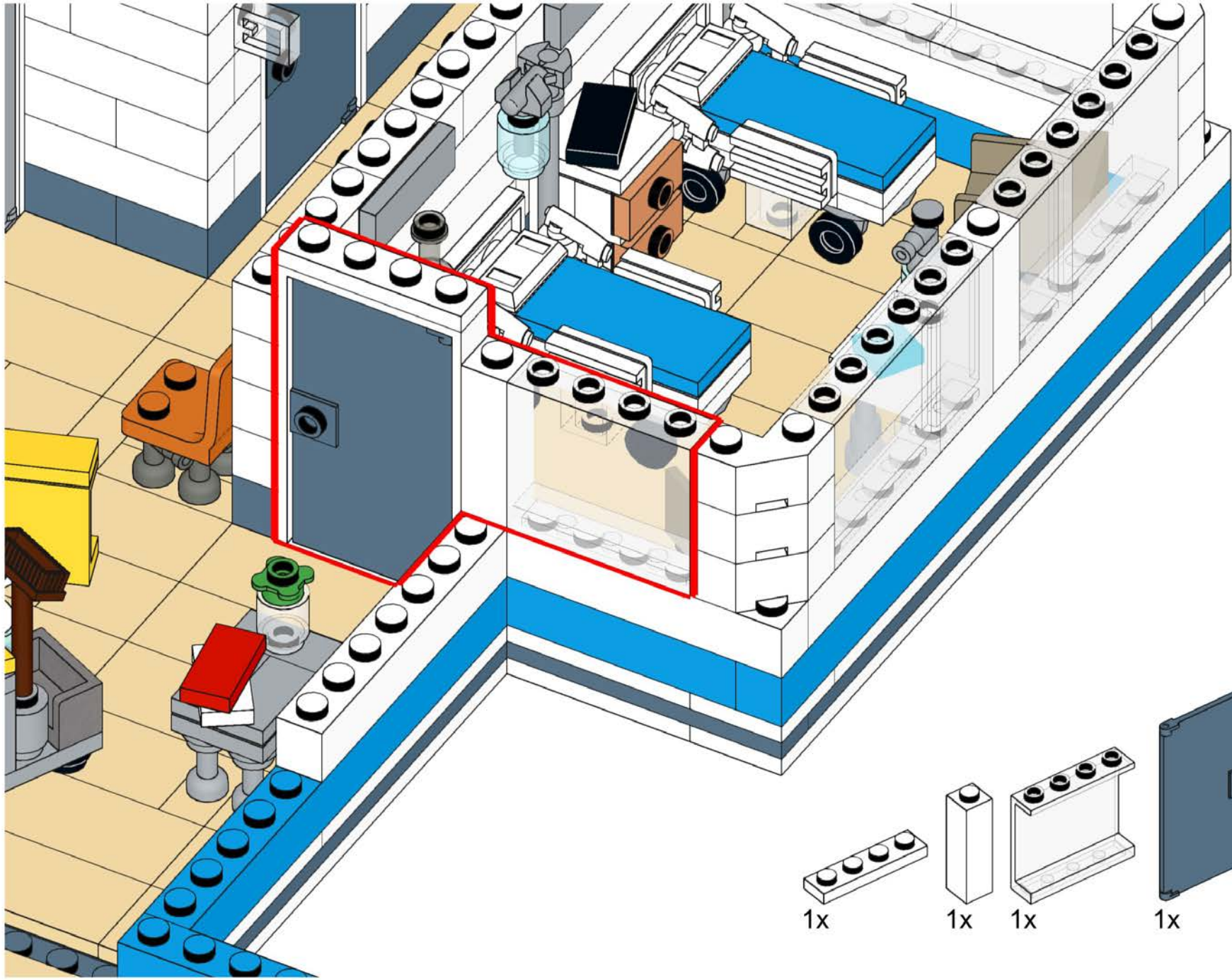

441

- 1x
- 1x
- 1x
- 1x
- 1x

# 442

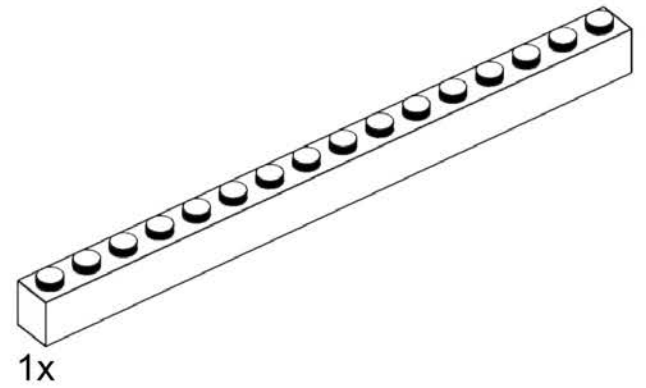
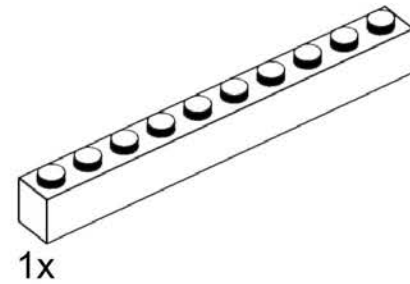
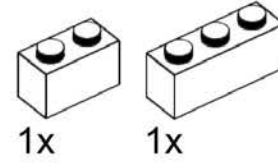
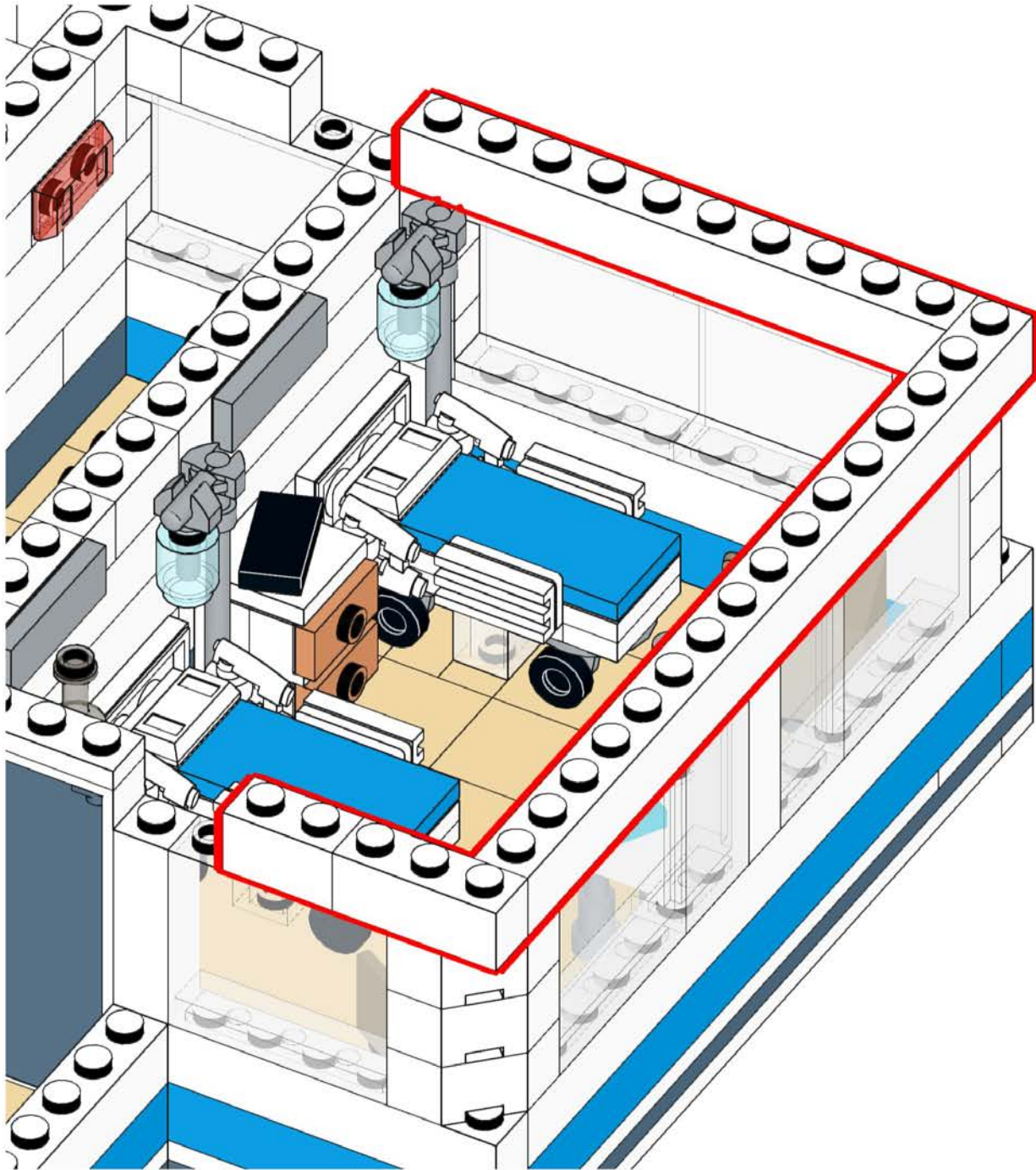

# 443

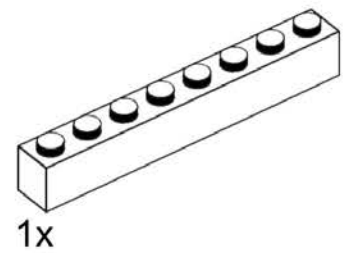
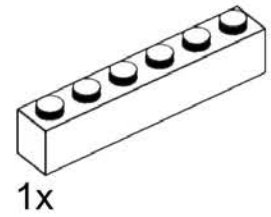
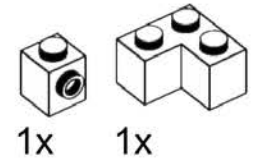
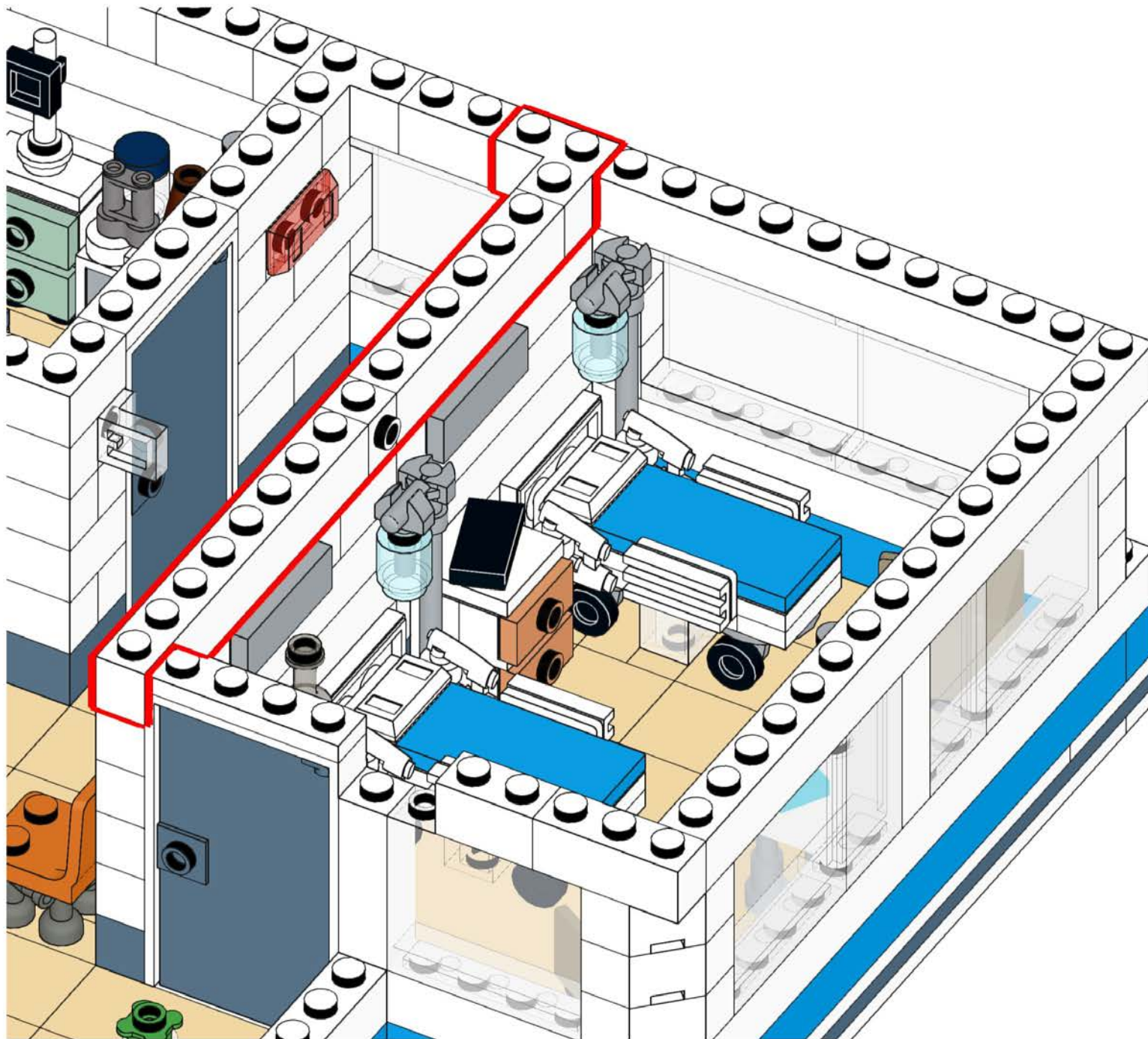

# 444

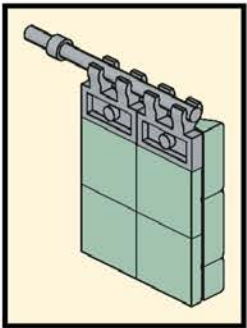
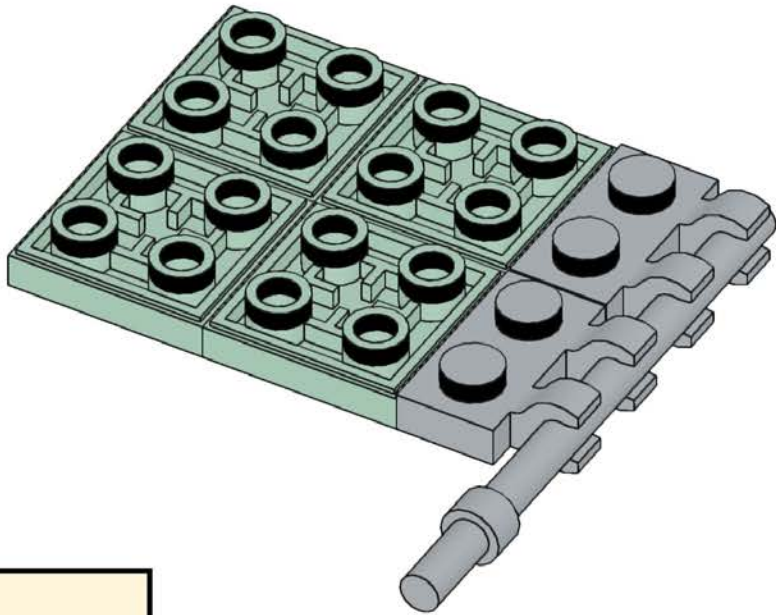
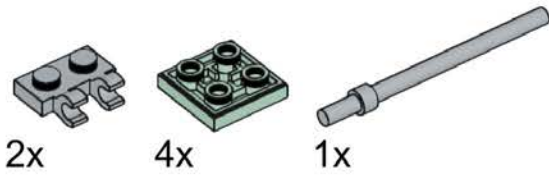

# 445

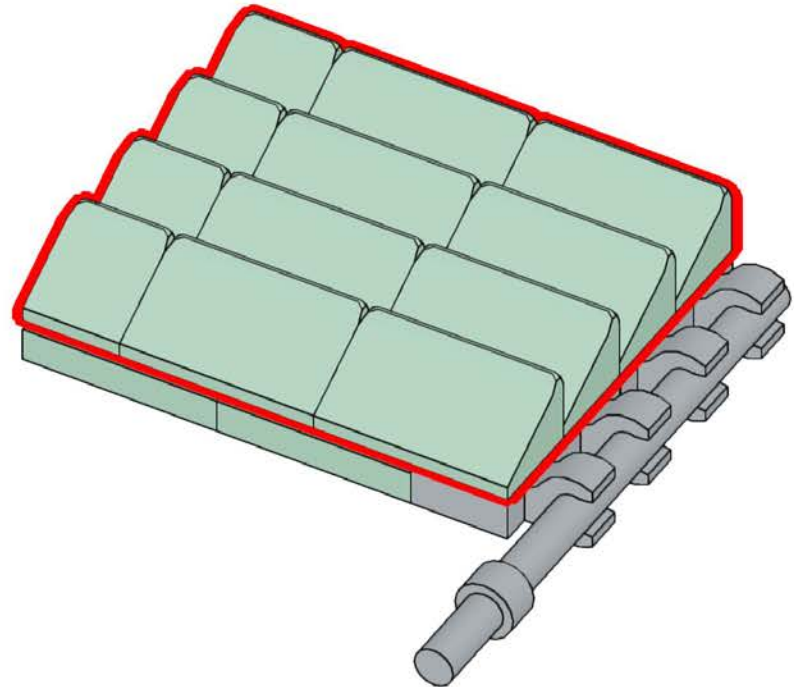
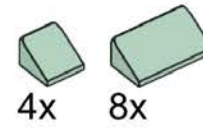

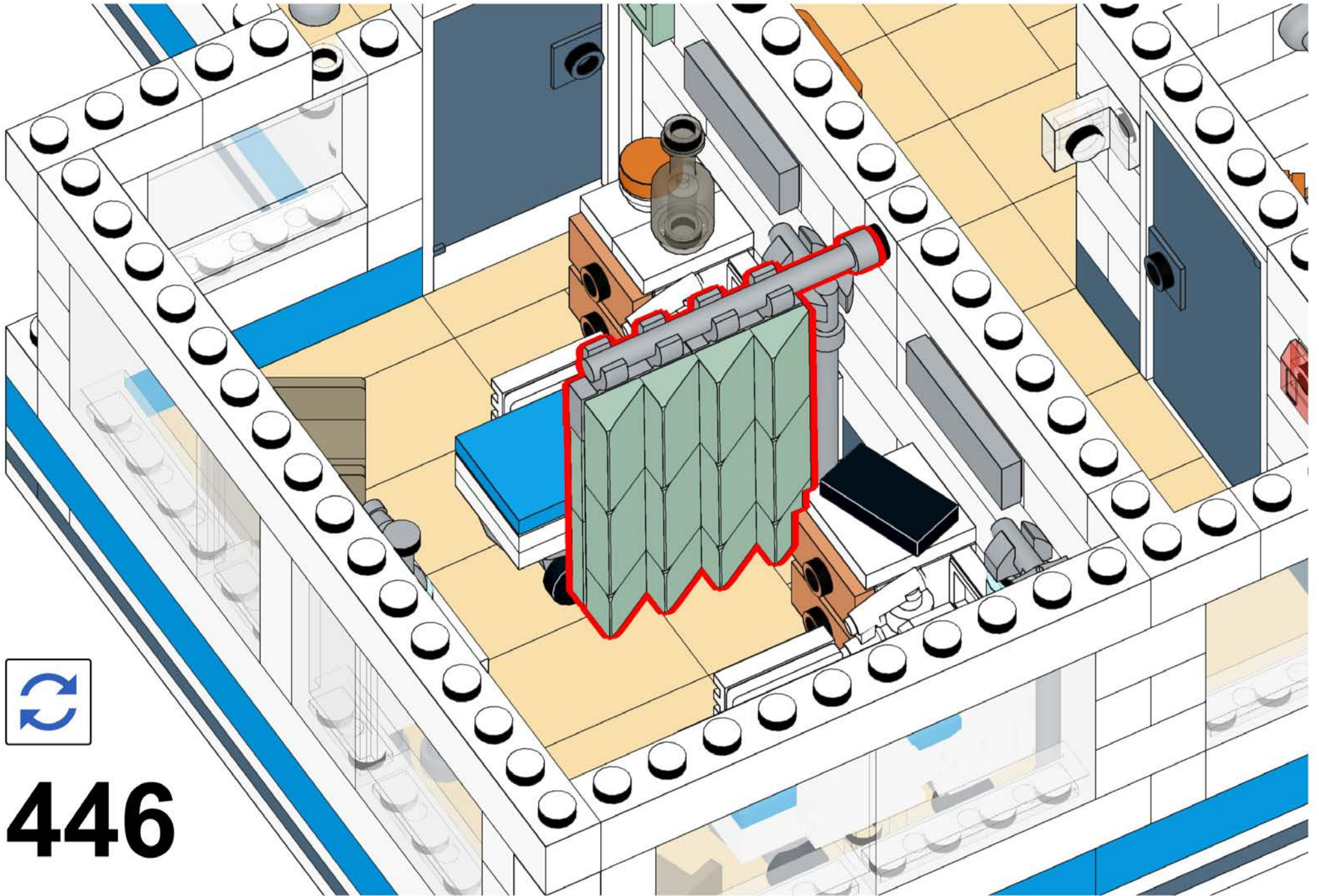



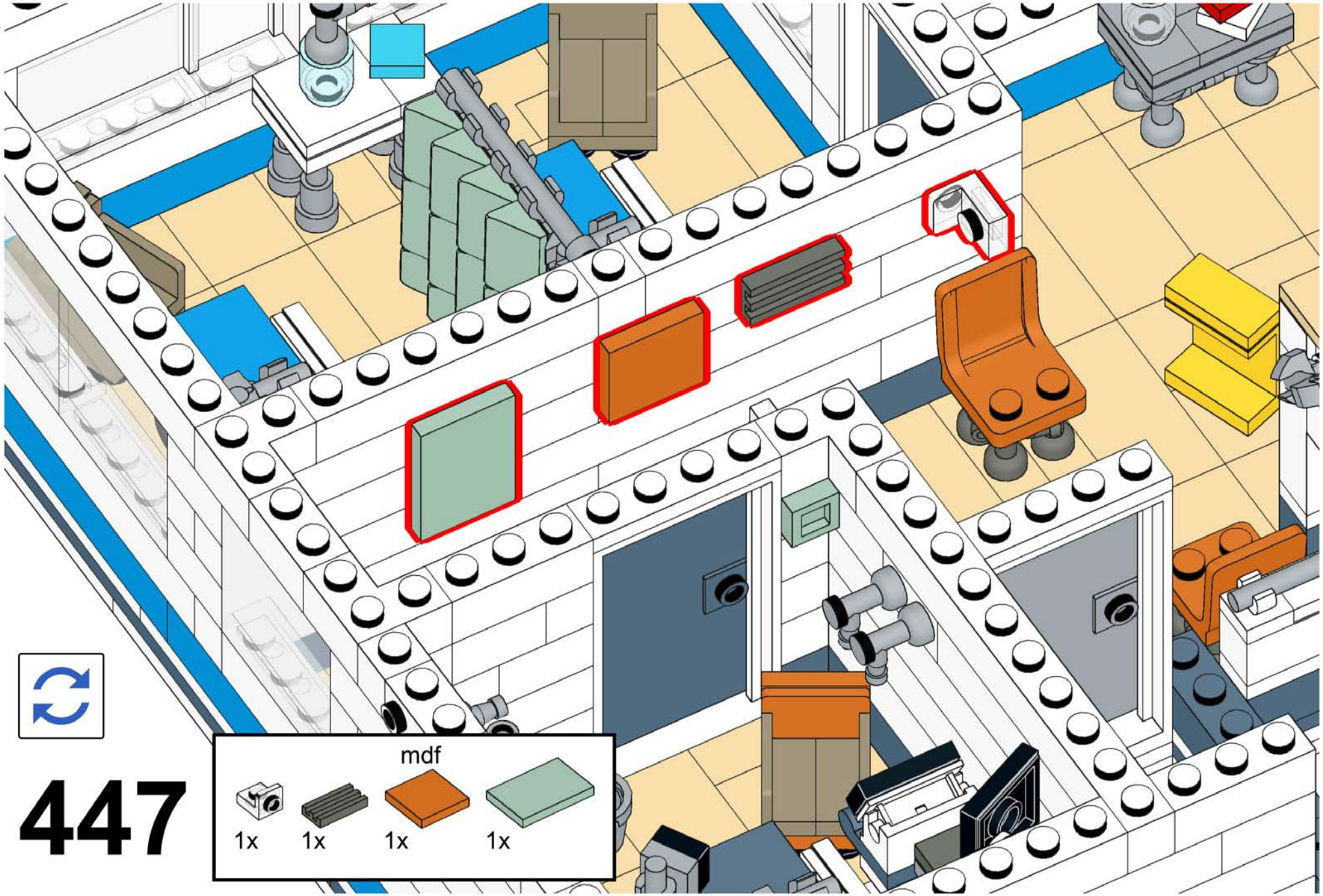

446



447

- |                                                                                     |                                                                                     |                                                                                     |                                                                                      |
|-------------------------------------------------------------------------------------|-------------------------------------------------------------------------------------|-------------------------------------------------------------------------------------|--------------------------------------------------------------------------------------|
|                                                                                     |                                                                                     | mdf                                                                                 |                                                                                      |
|  |  |  |  |
| 1x                                                                                  | 1x                                                                                  | 1x                                                                                  | 1x                                                                                   |

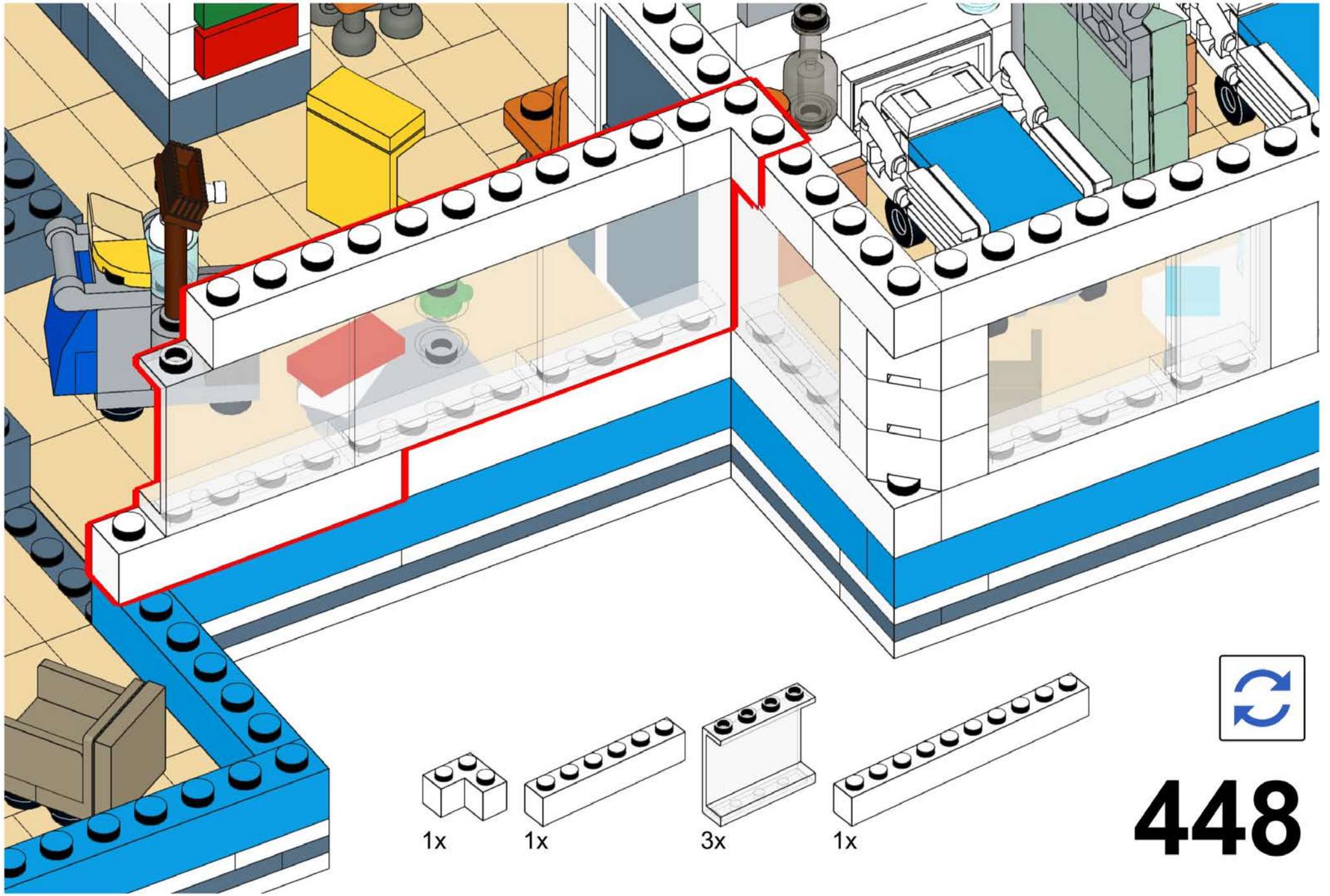

1x

1x

3x

1x



448

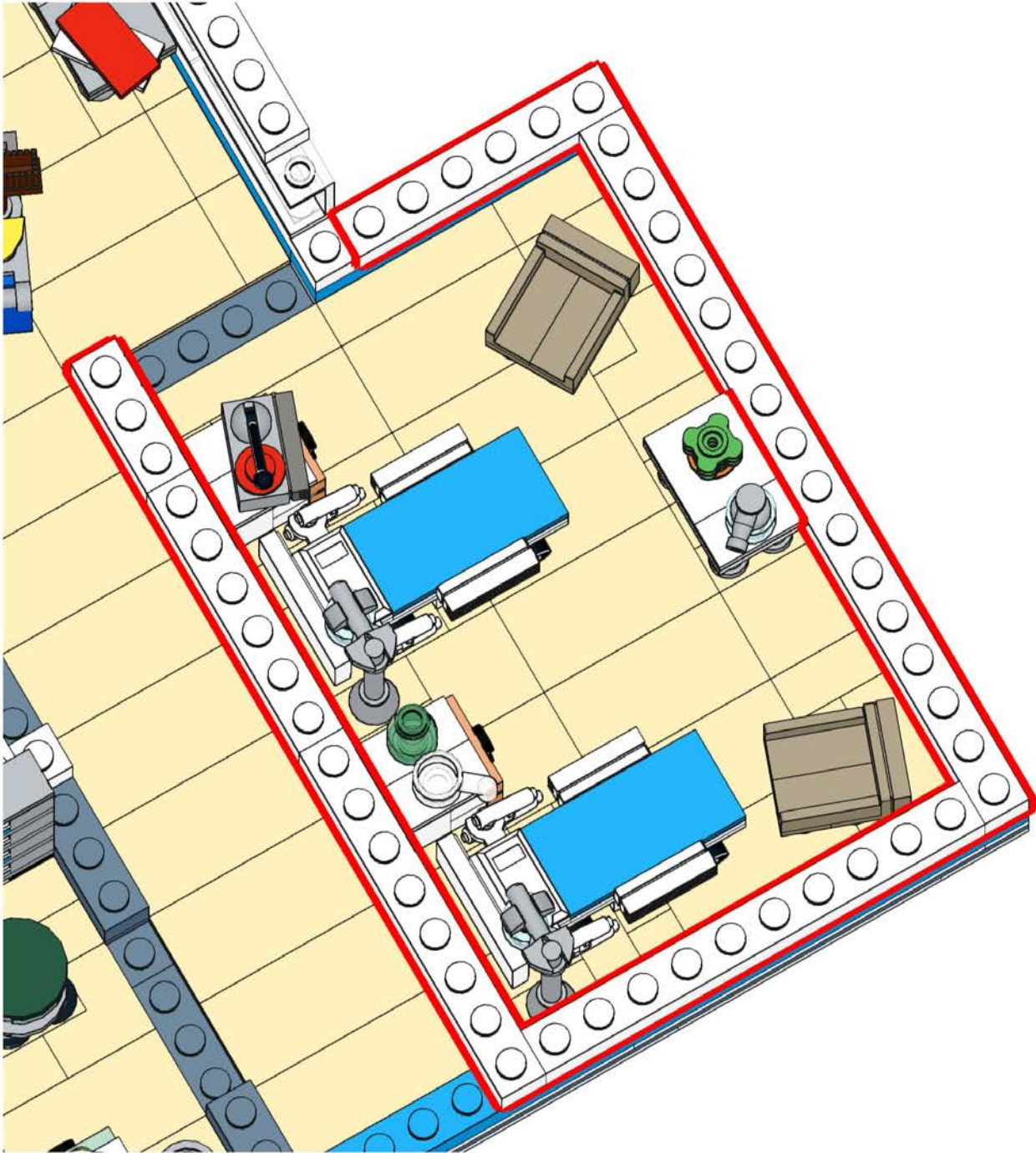

# 449



1x

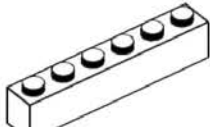

2x

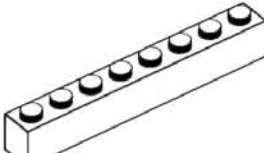

1x

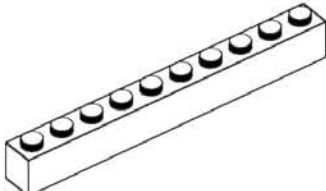

1x

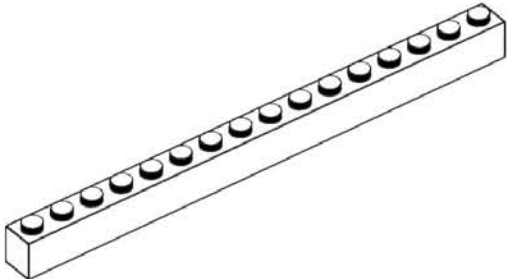

1x



# 450

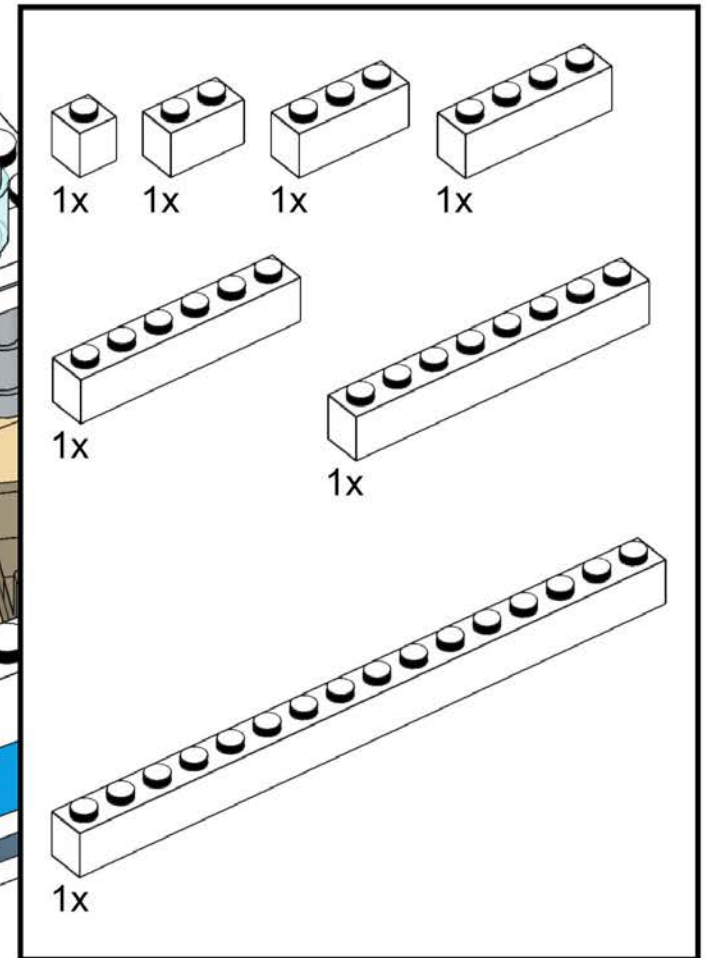
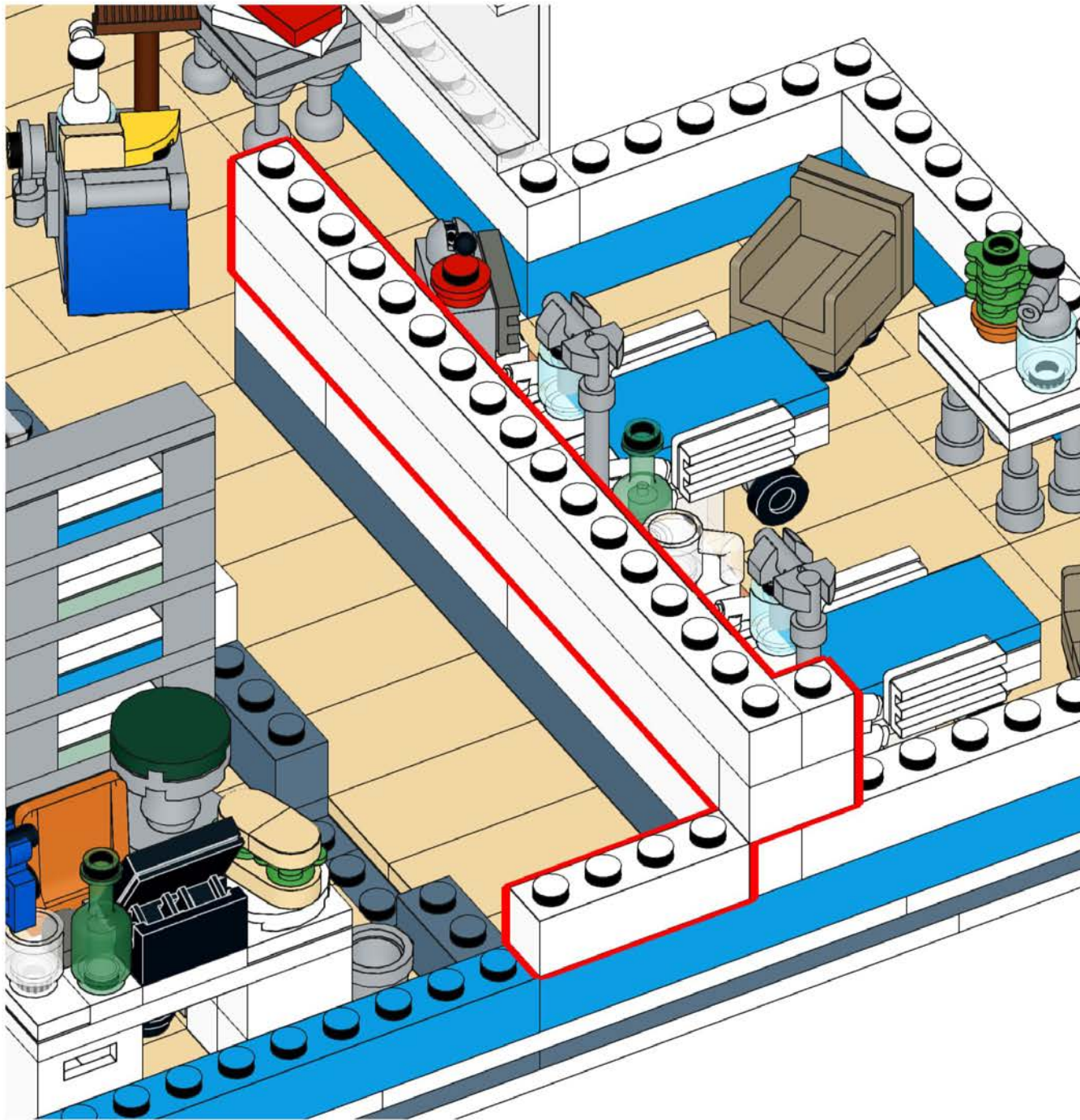



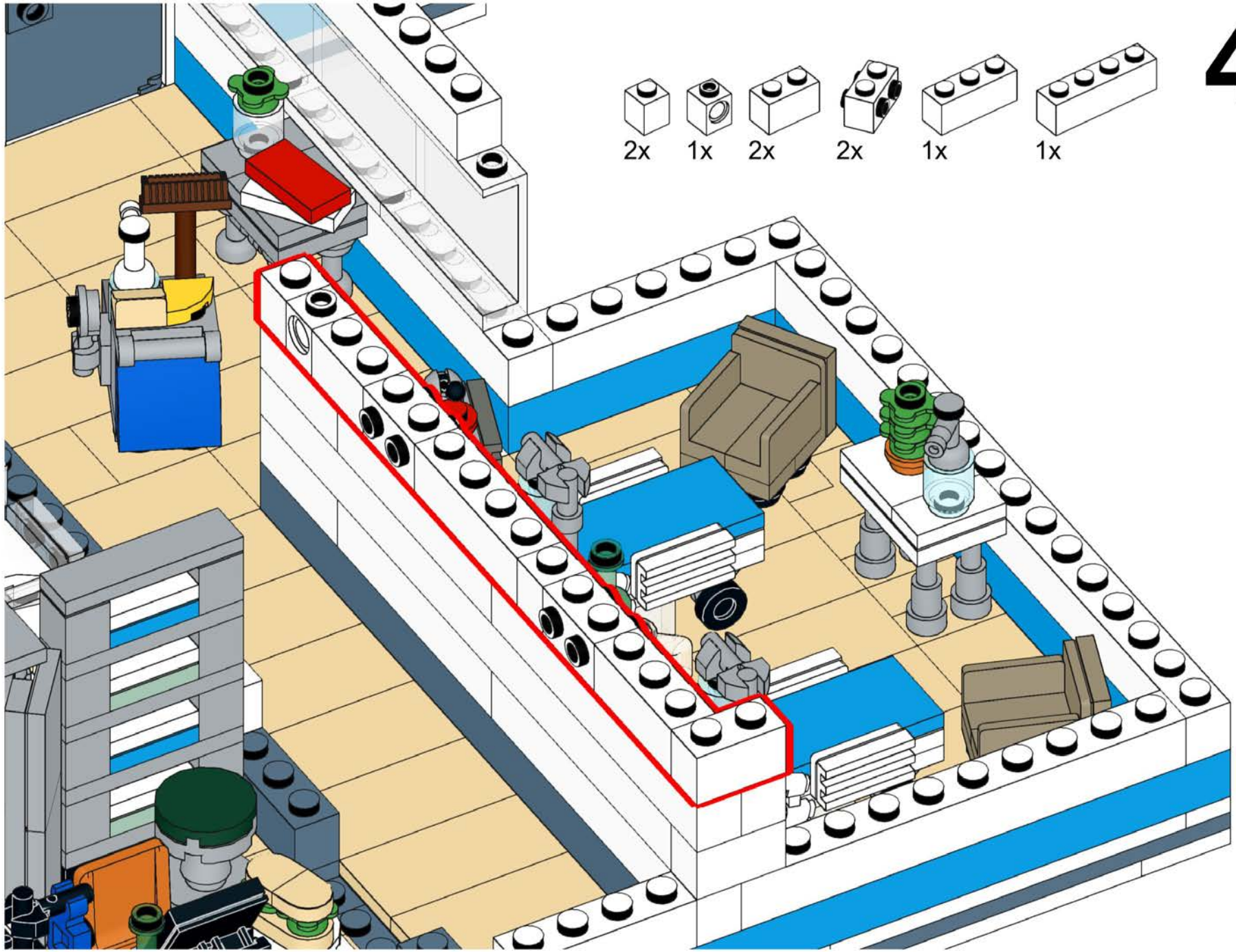

# 451

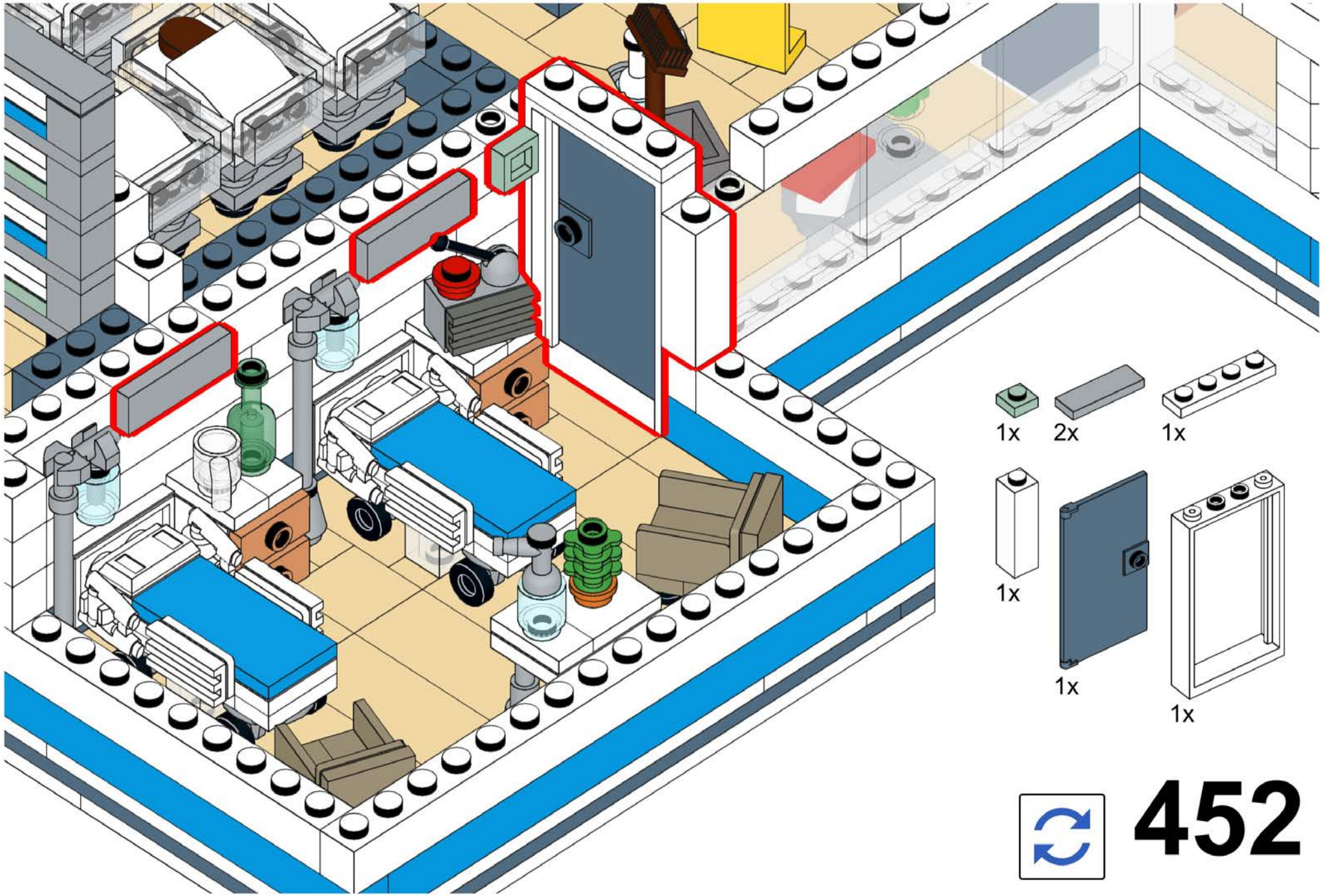
- 2x
- 1x
- 2x
- 2x
- 1x
- 1x



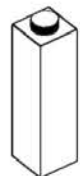

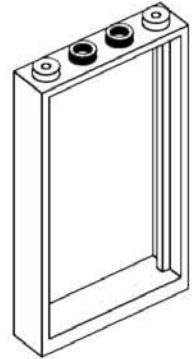



- 1x 
- 2x 
- 1x 
- 1x 
- 1x 
- 1x 

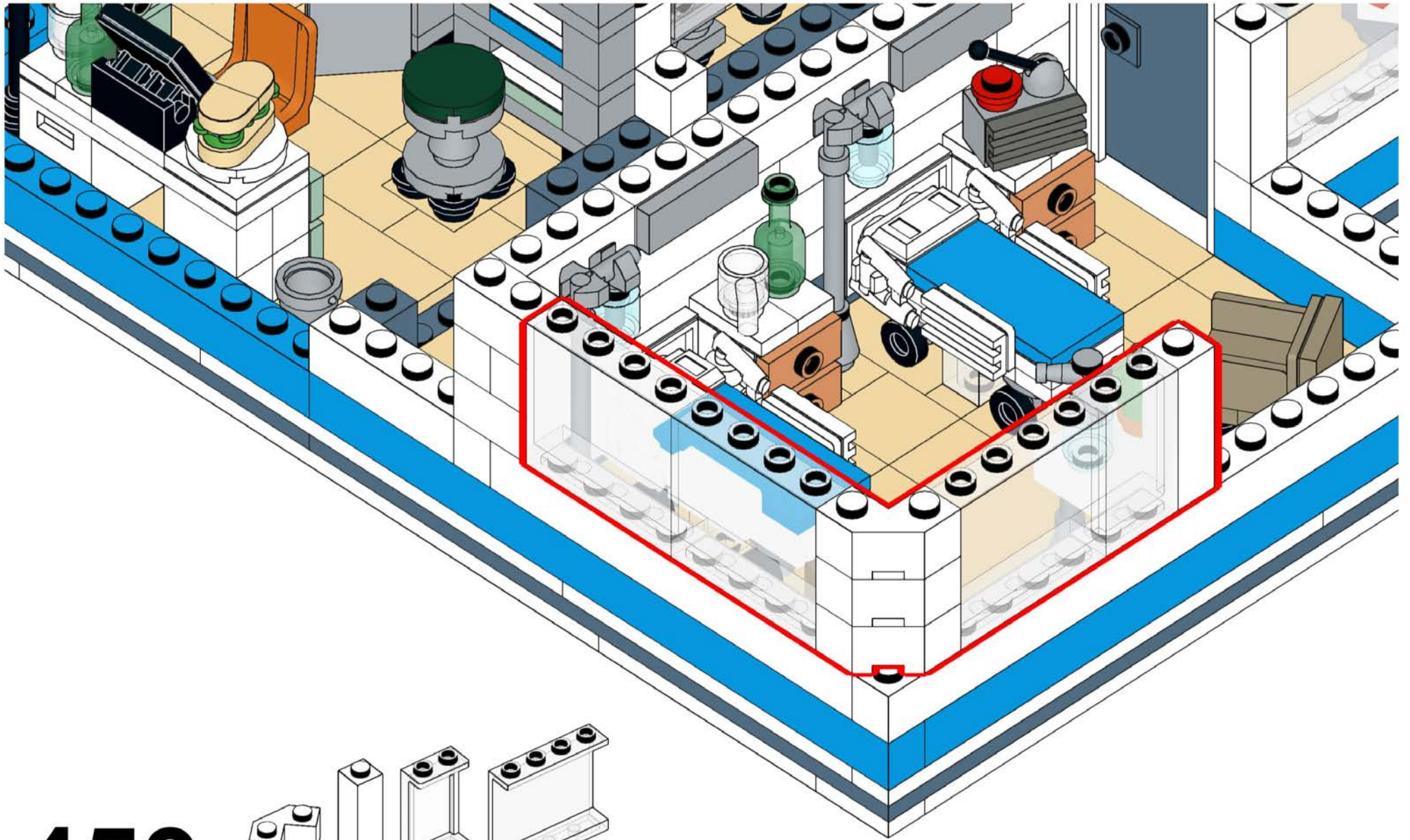

**452**

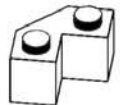

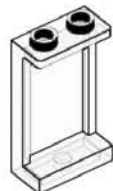
**453**

- 3x 
- 1x 
- 1x 
- 3x 

# 454

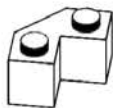

3x

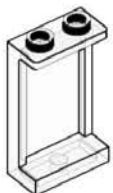

1x



2x

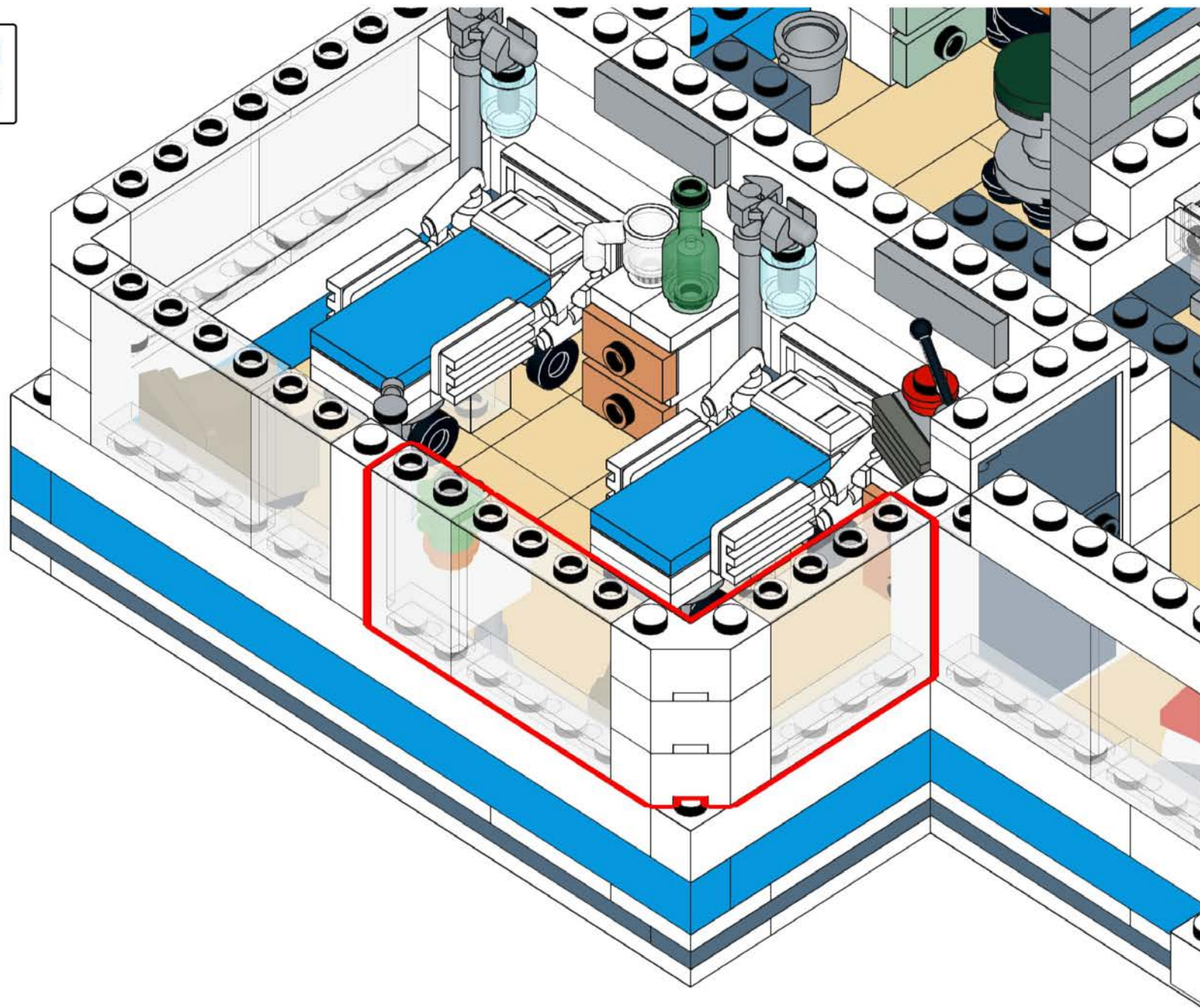

# 455

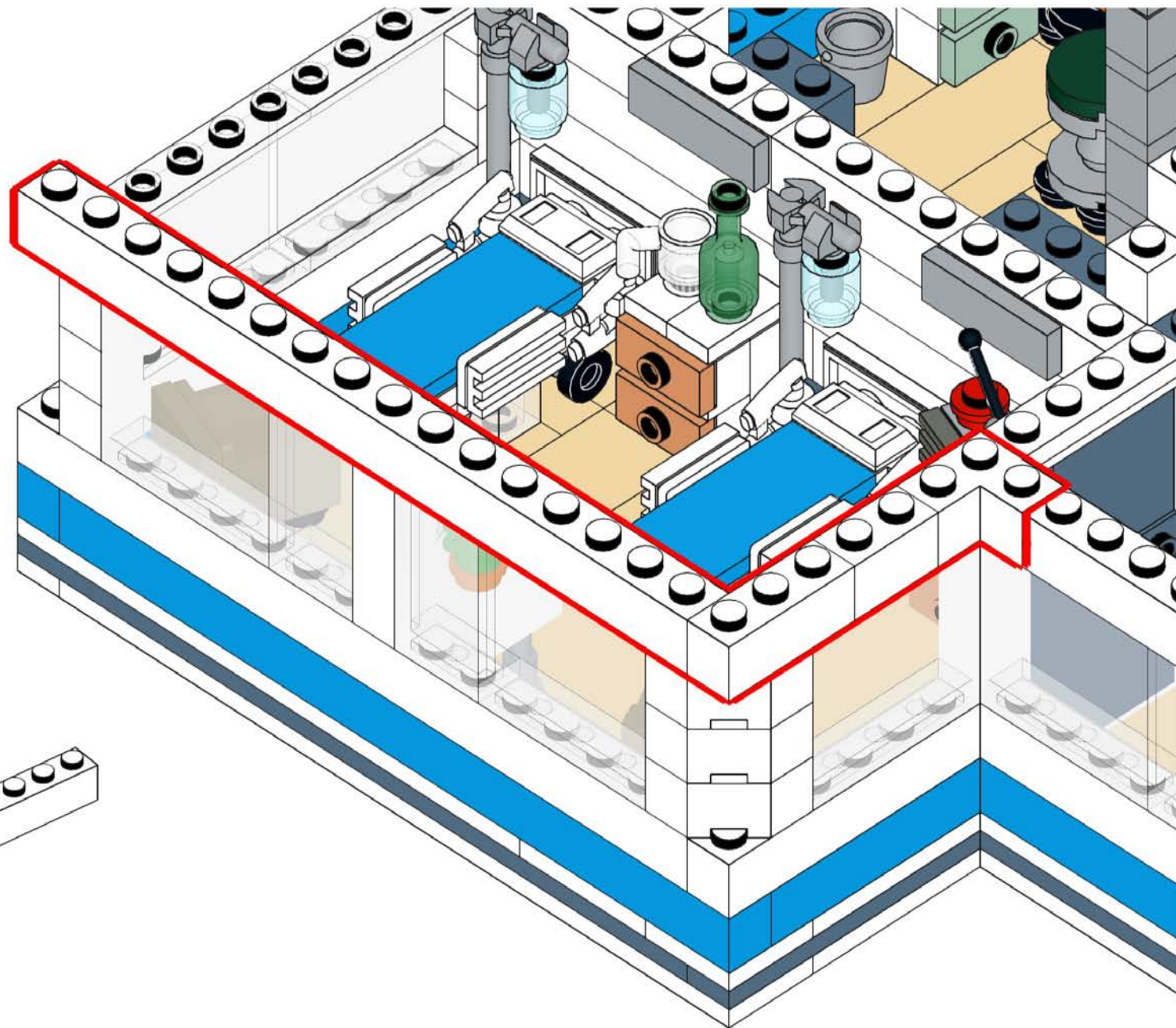
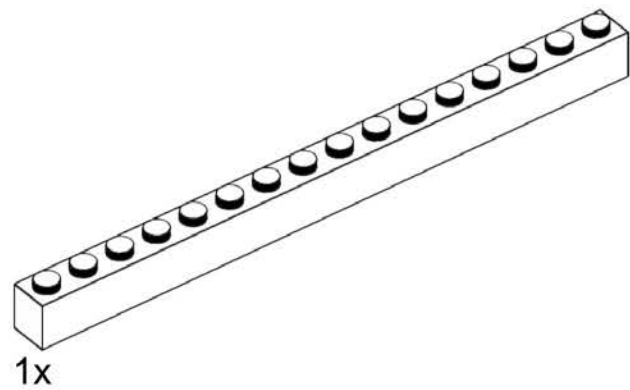
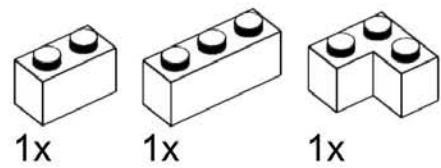

# 456

1x

1x

1x

1x

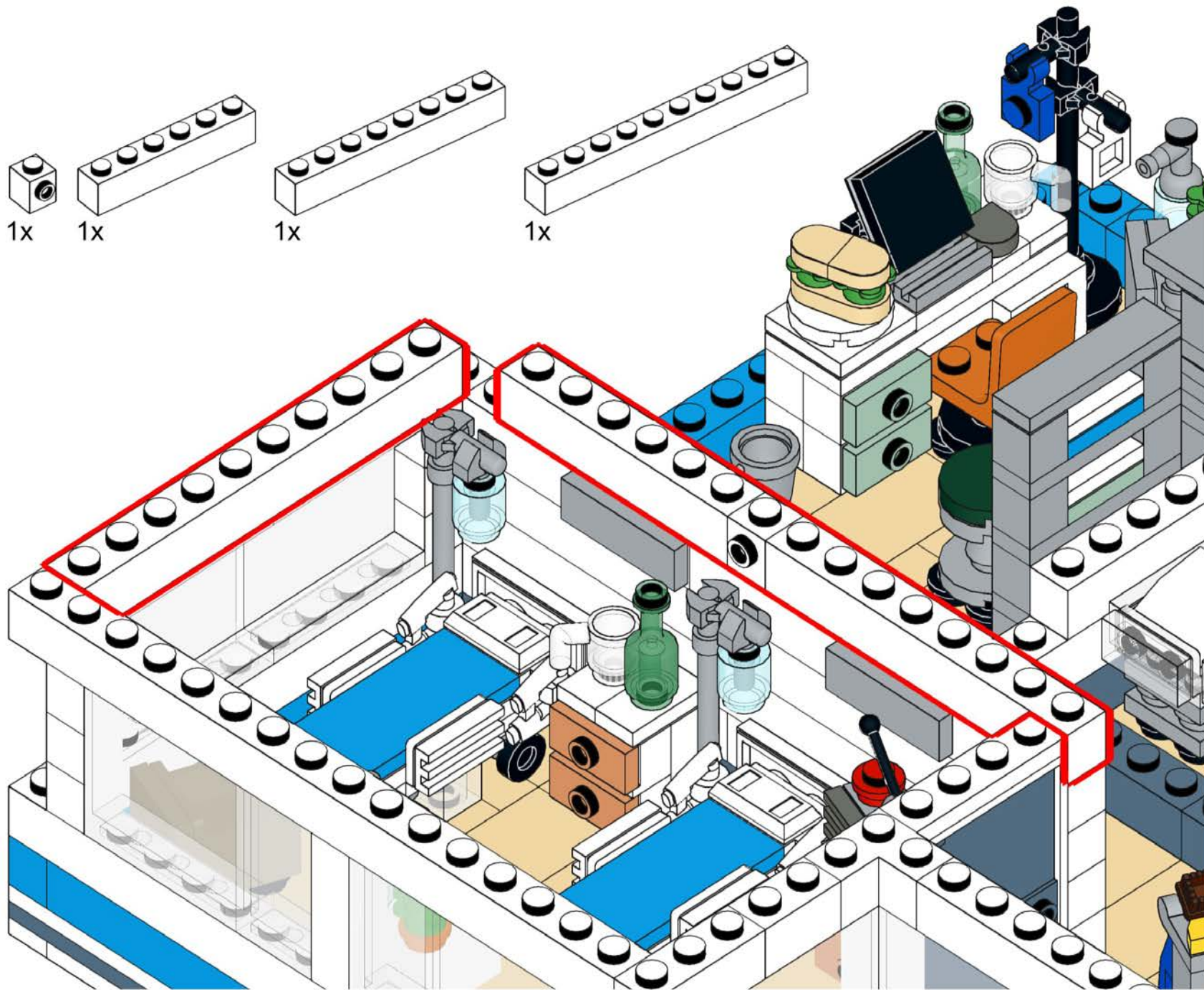

# 457

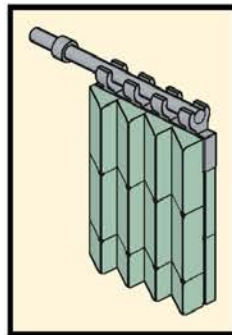
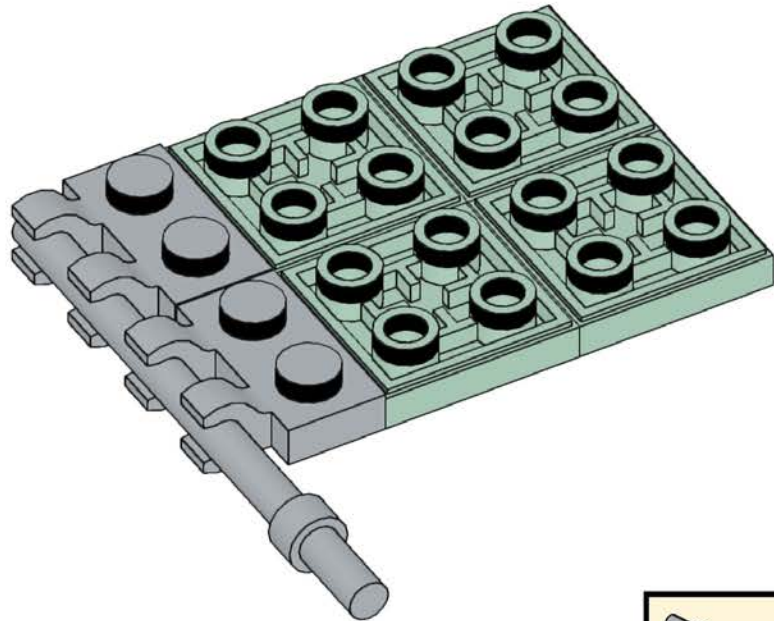
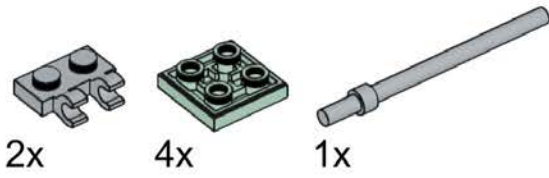

# 458

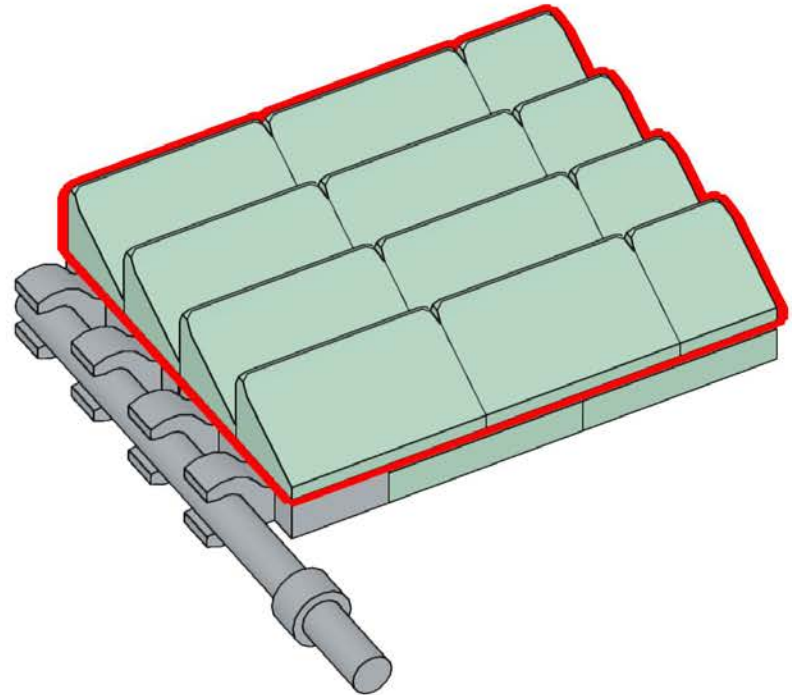
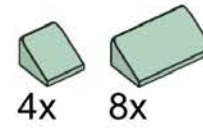



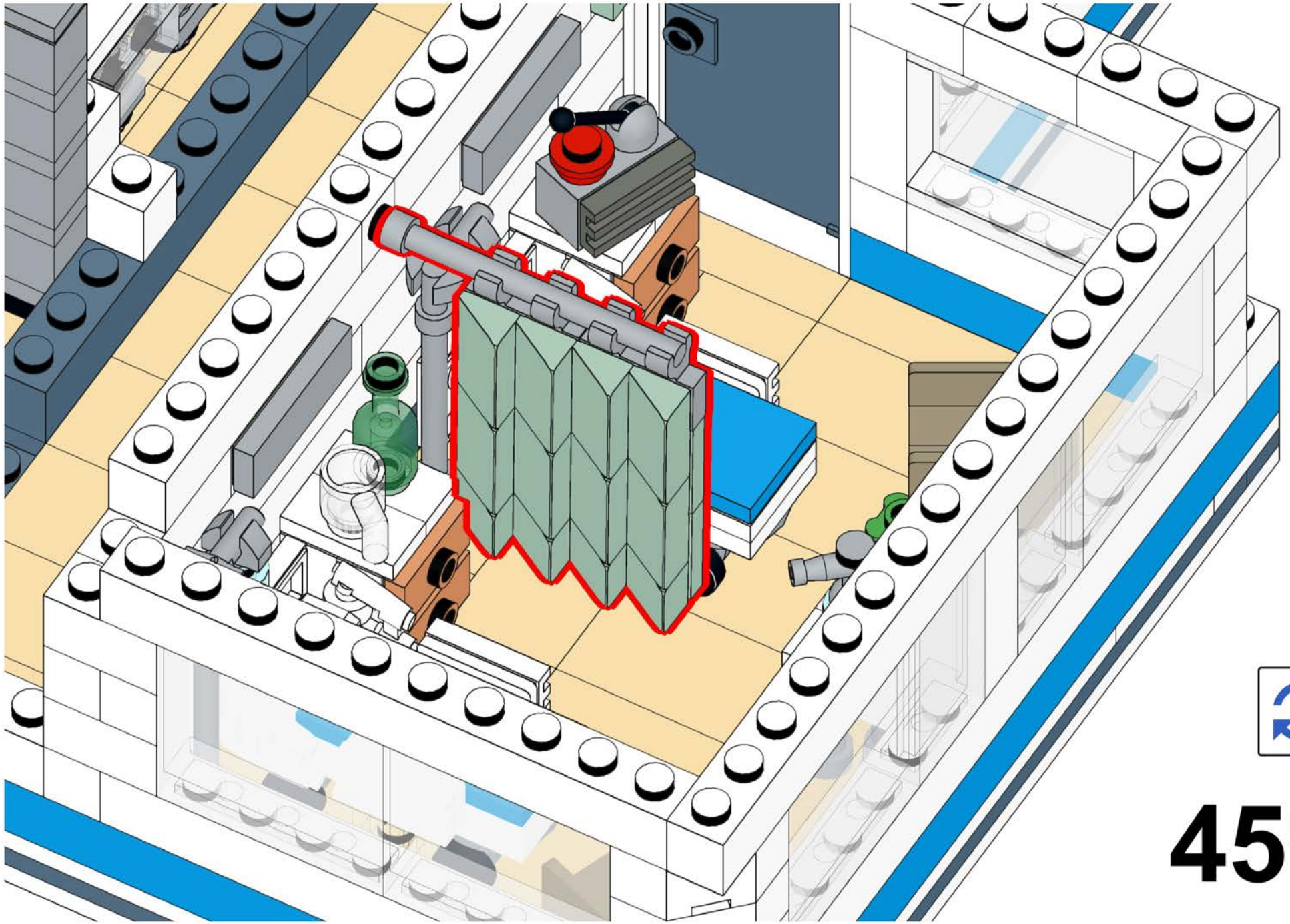

**459**

# 460

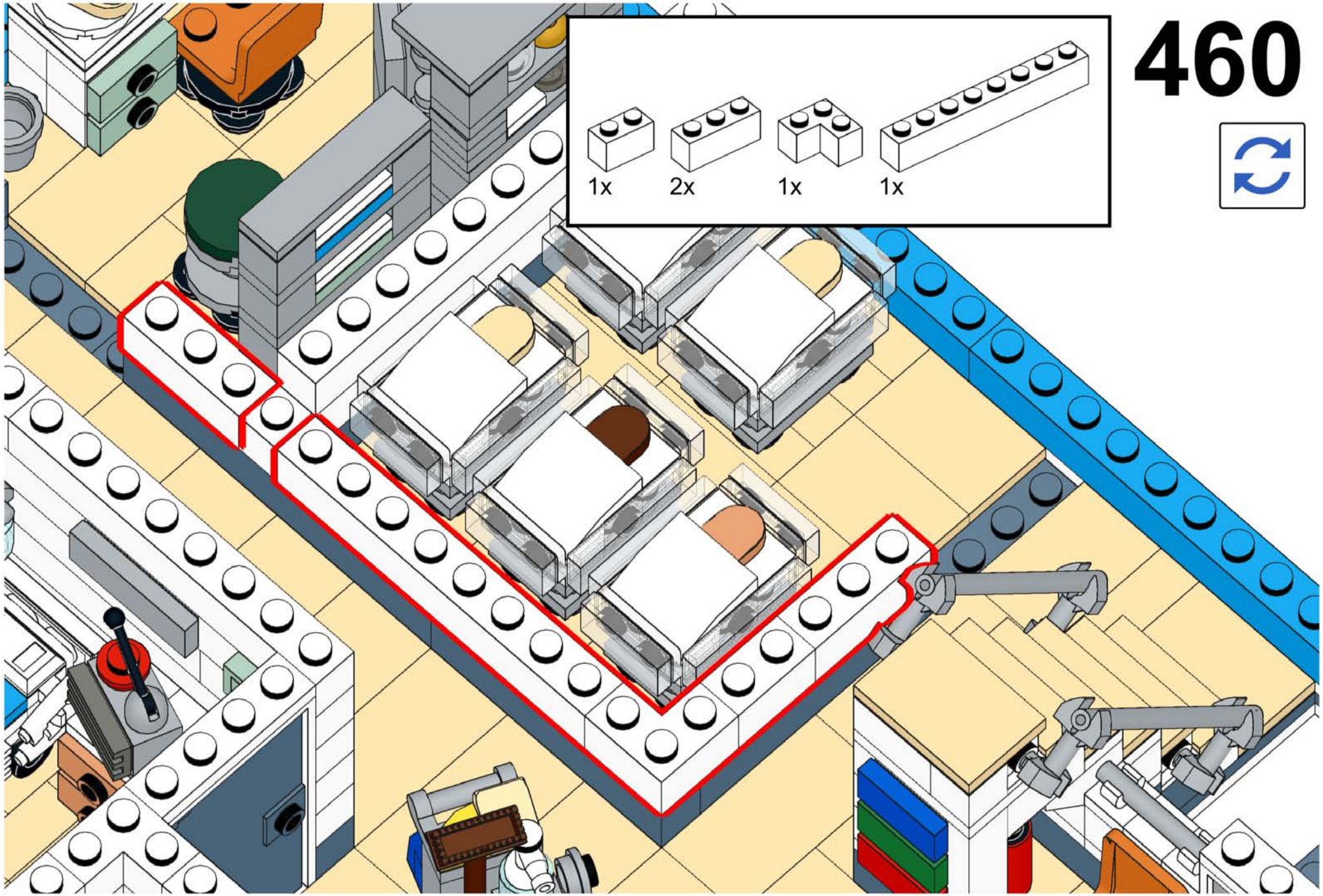
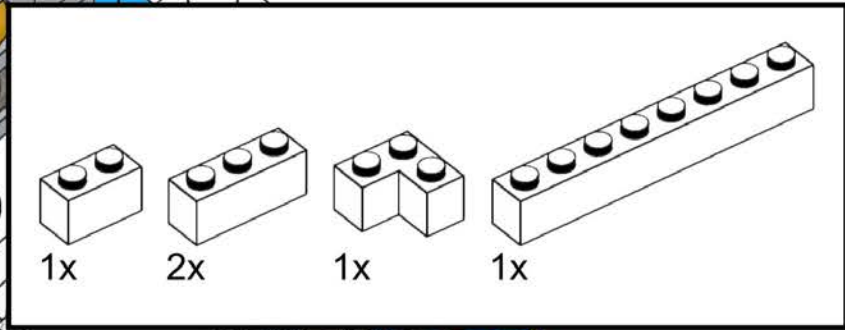

# 461

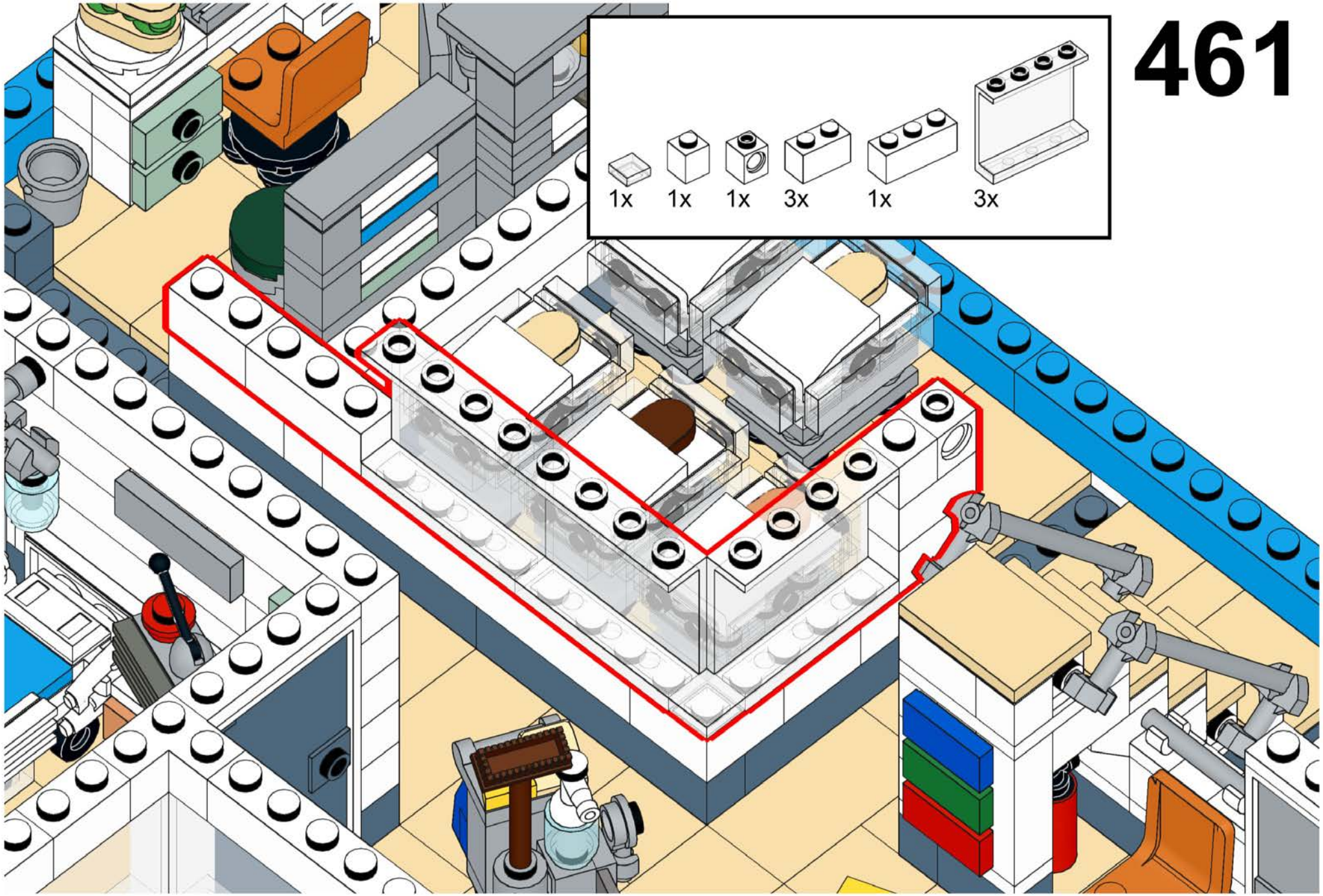
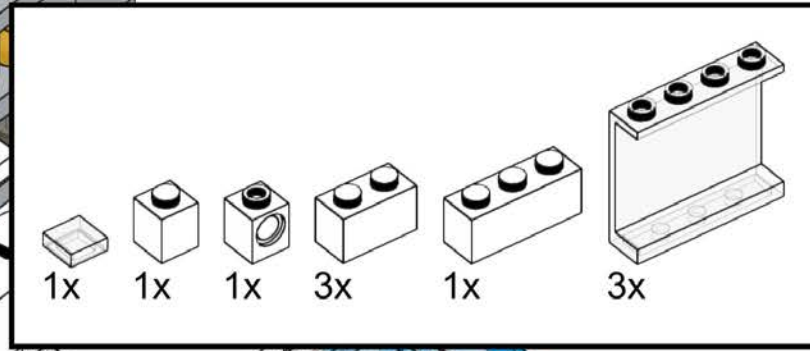

# 462

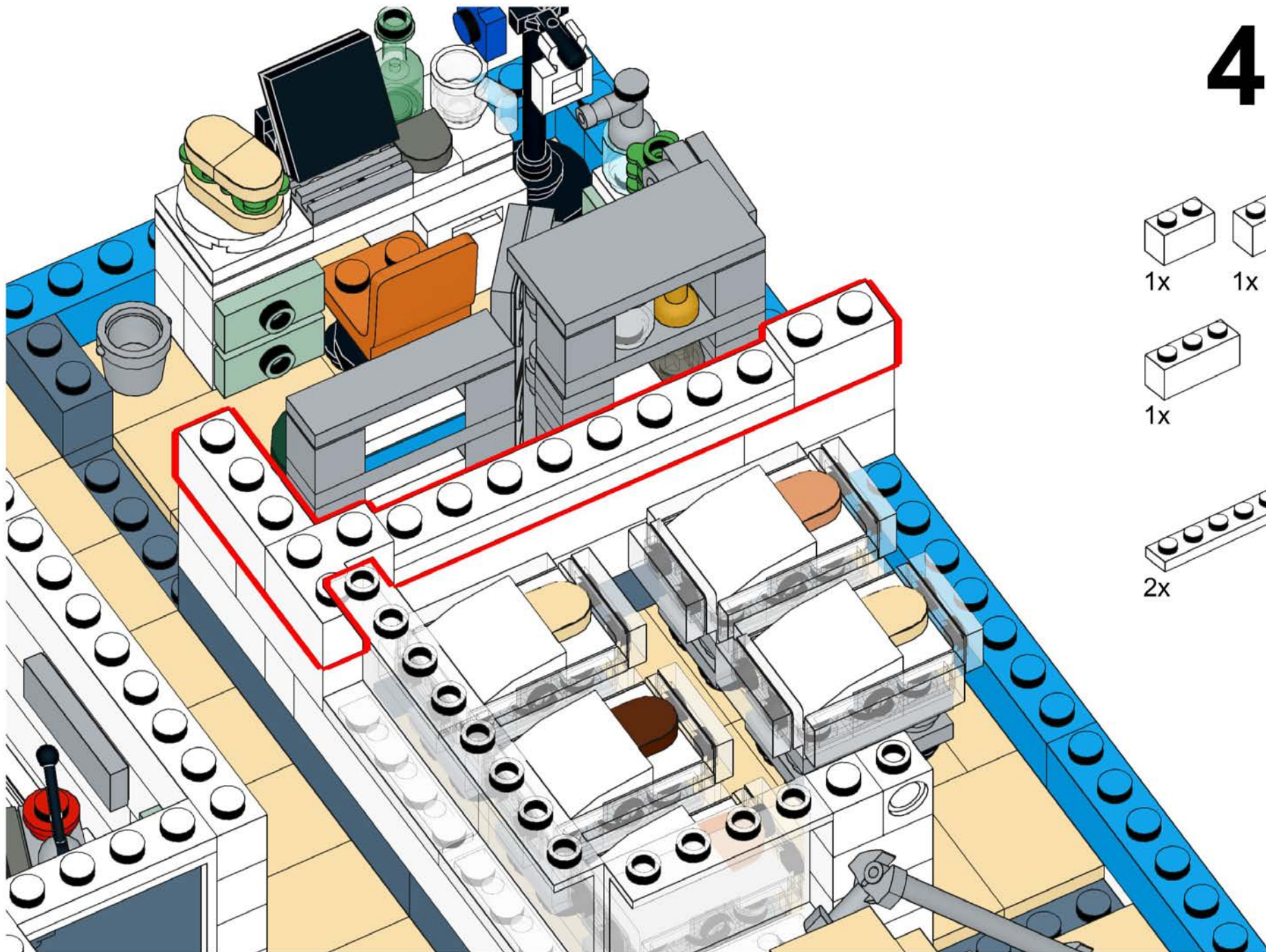

# 463

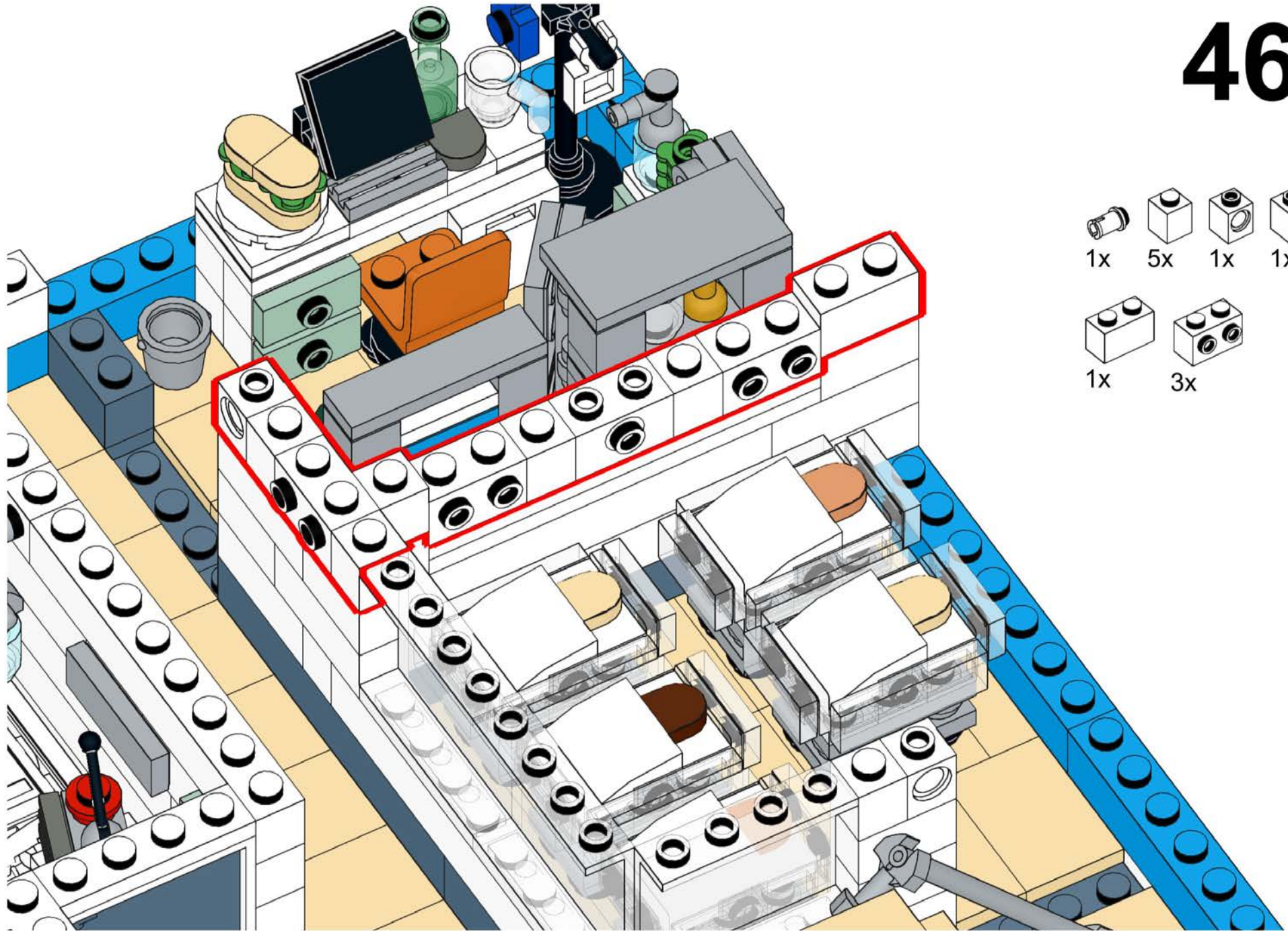

# 464

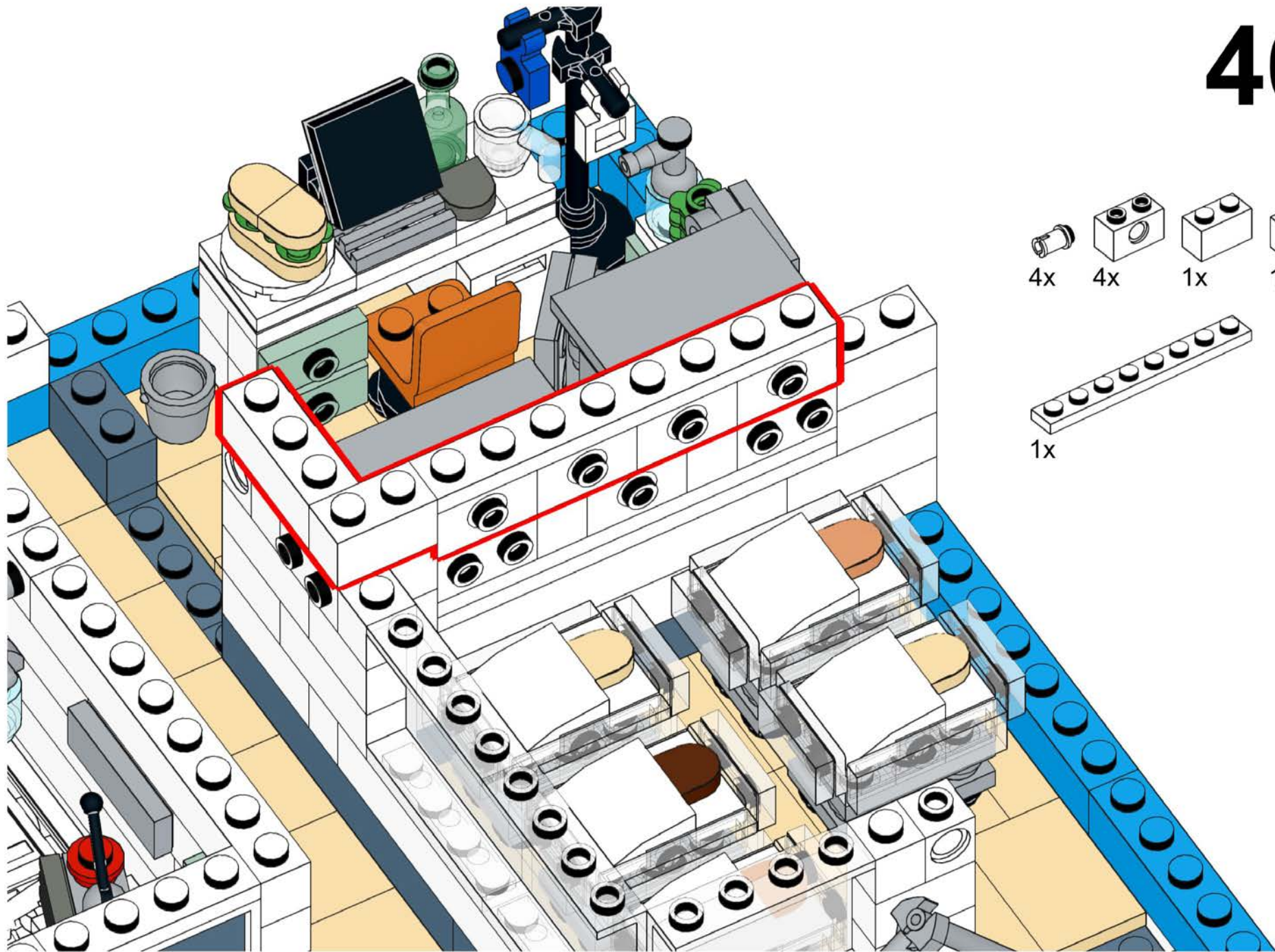

# 465

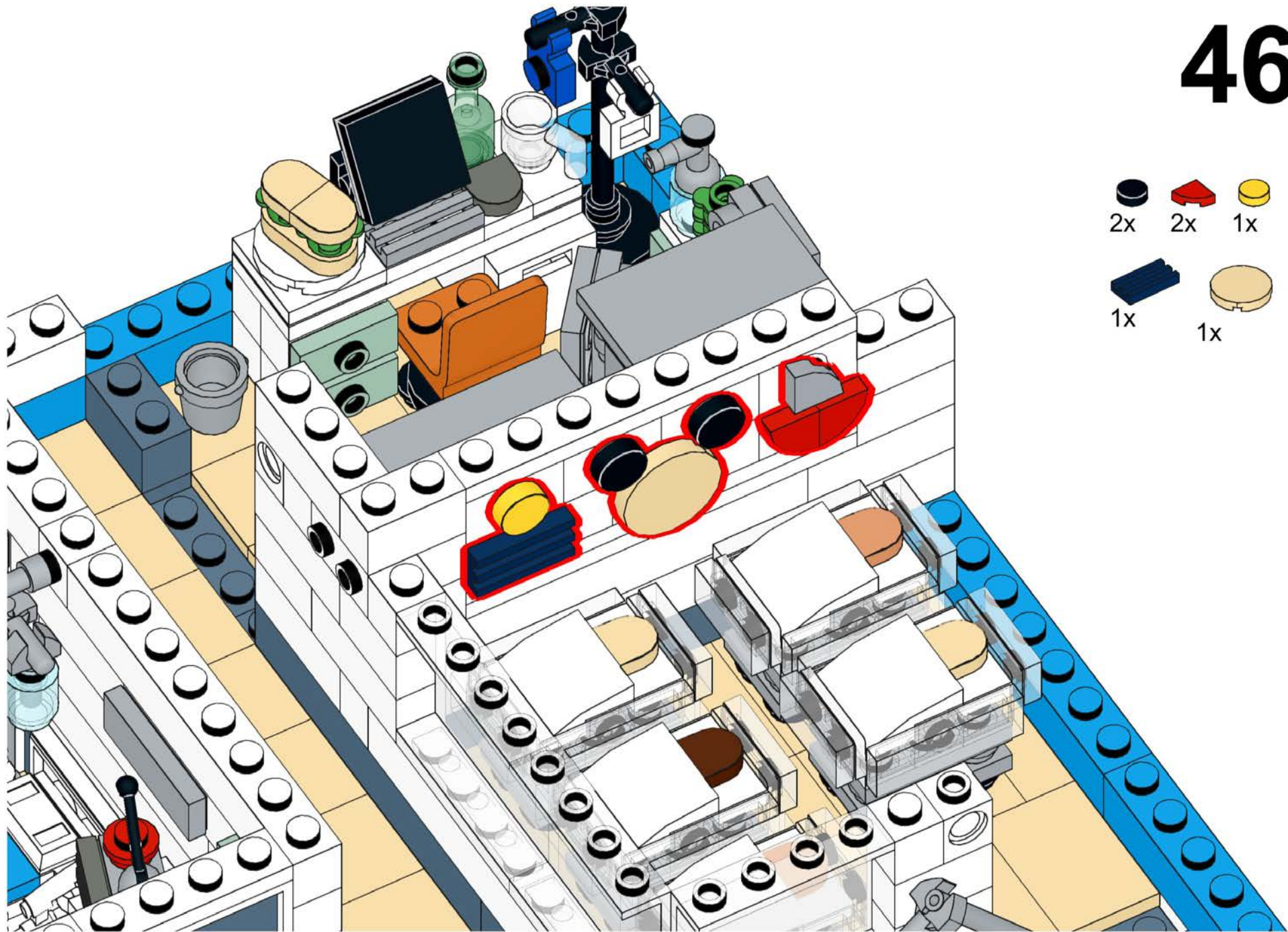

# 466

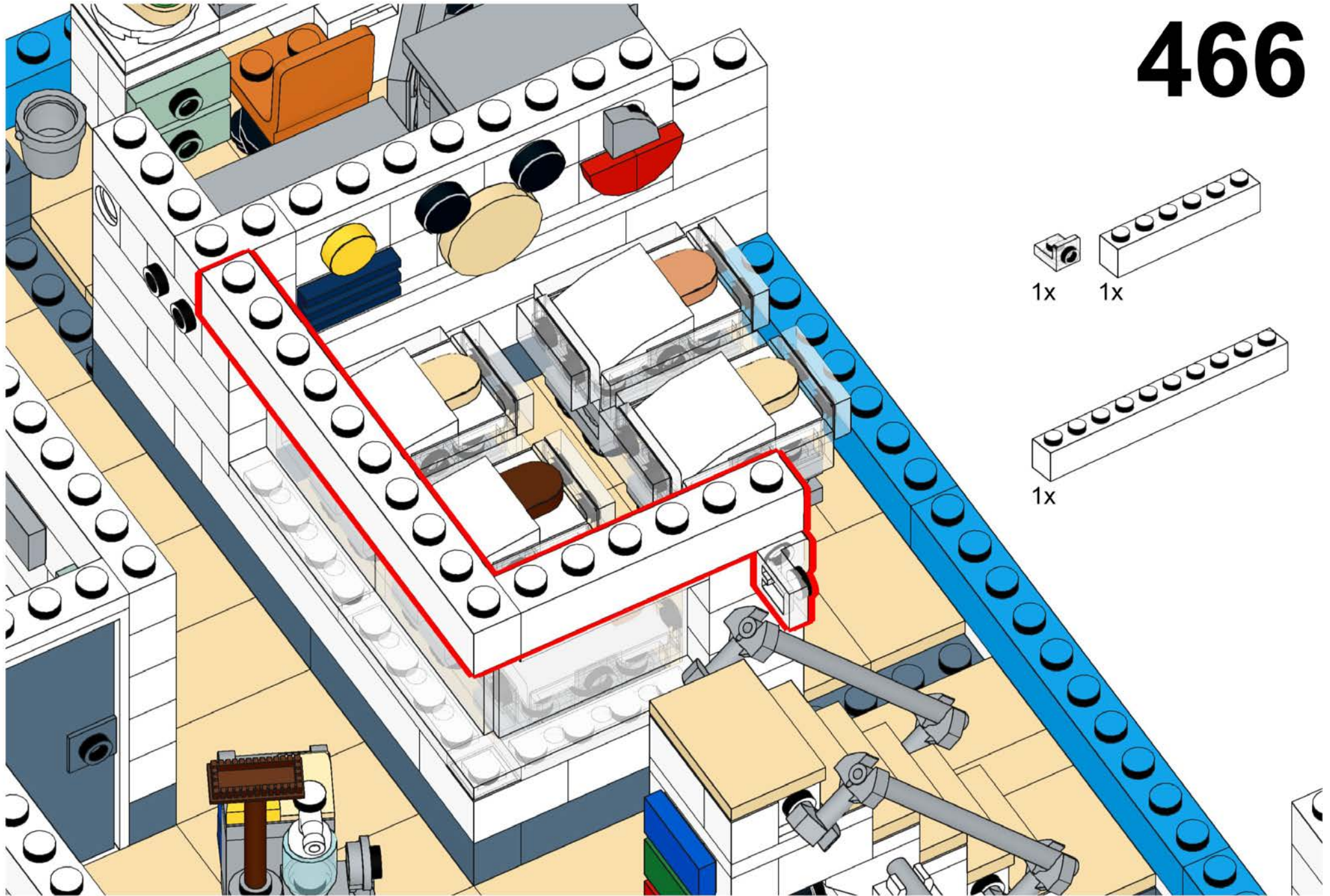





467

1x

1x

1x

1x

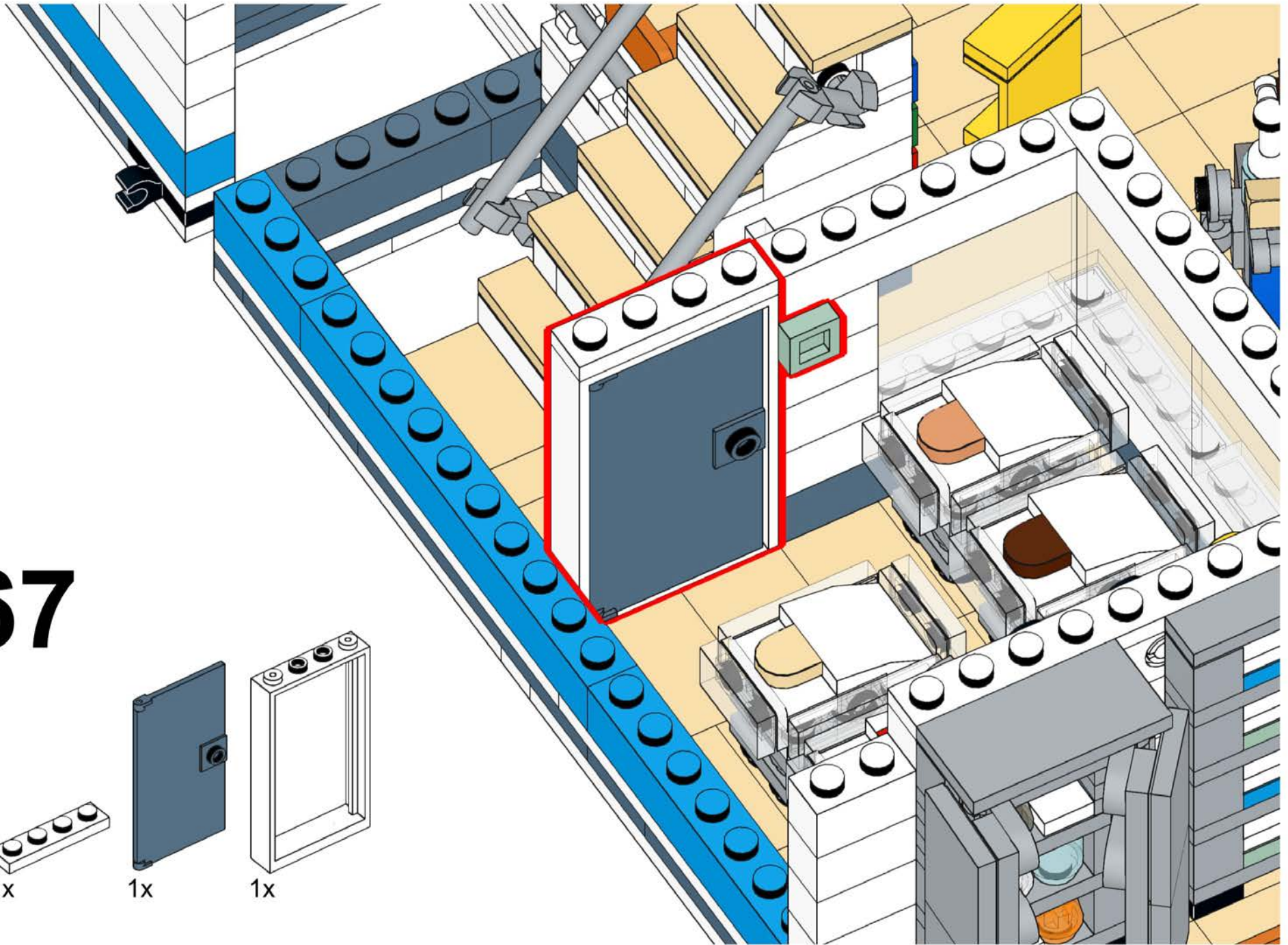

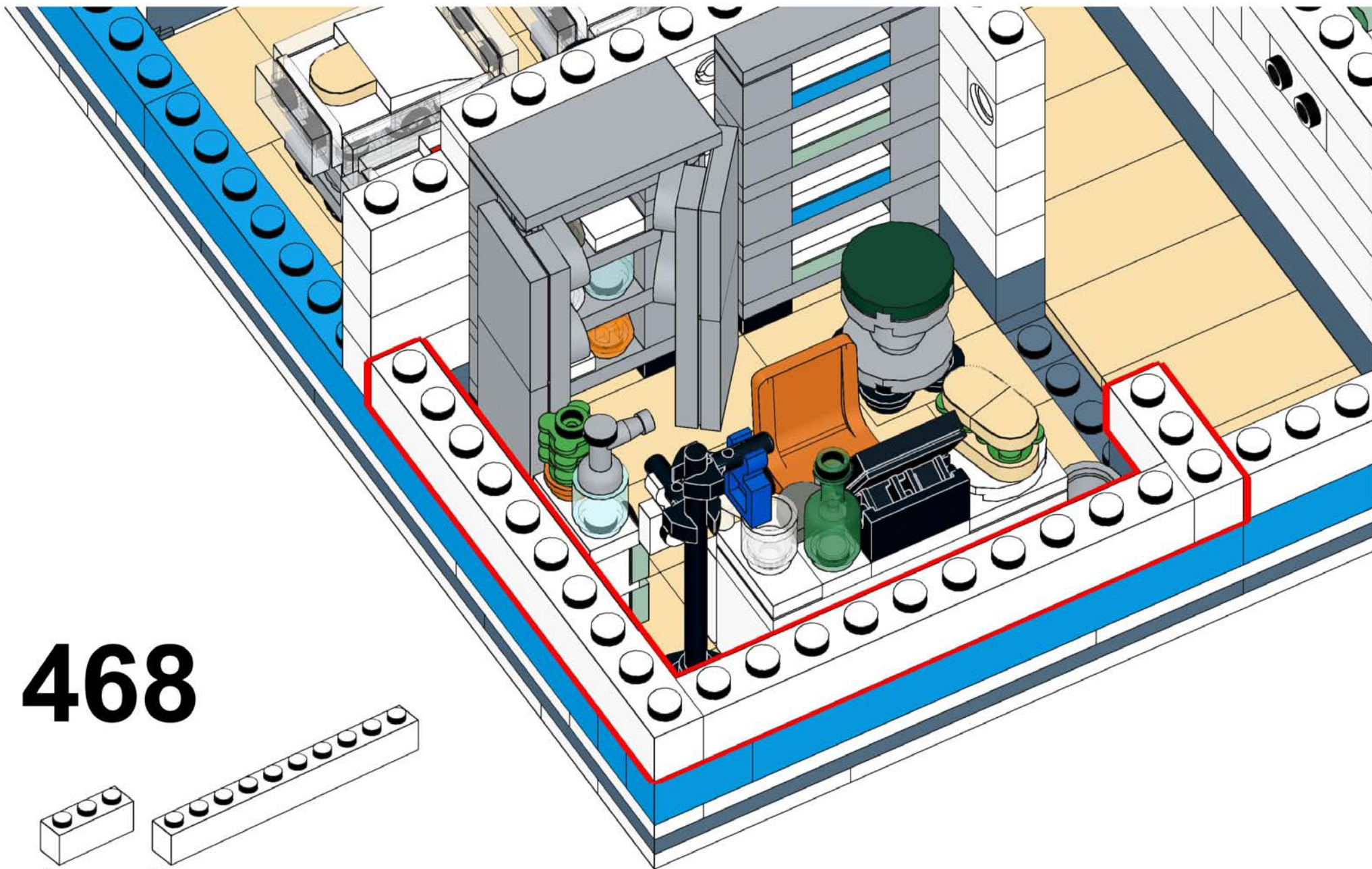

468

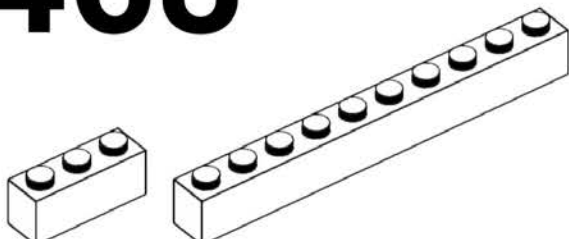

1x

2x

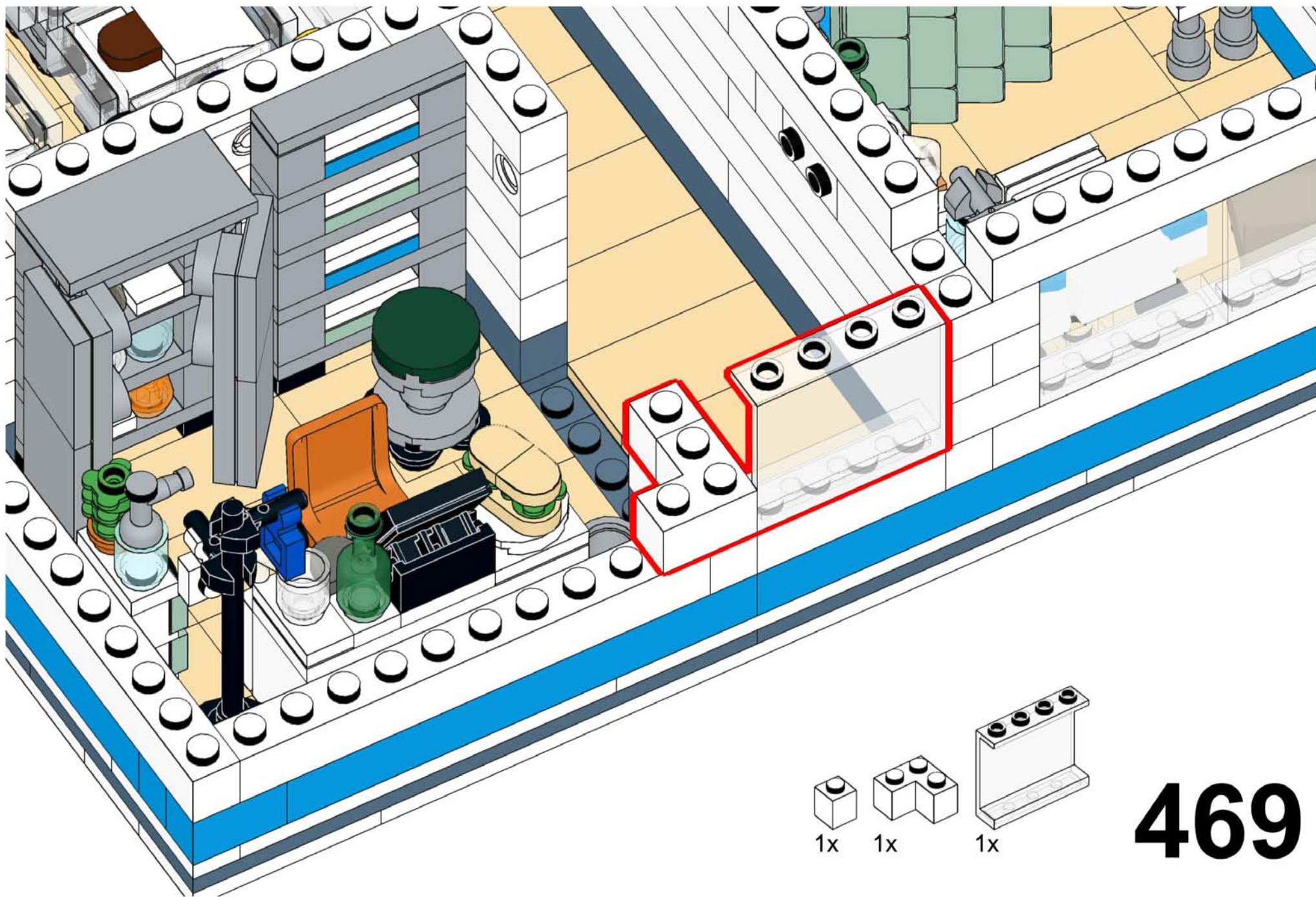

1x

1x

1x

469

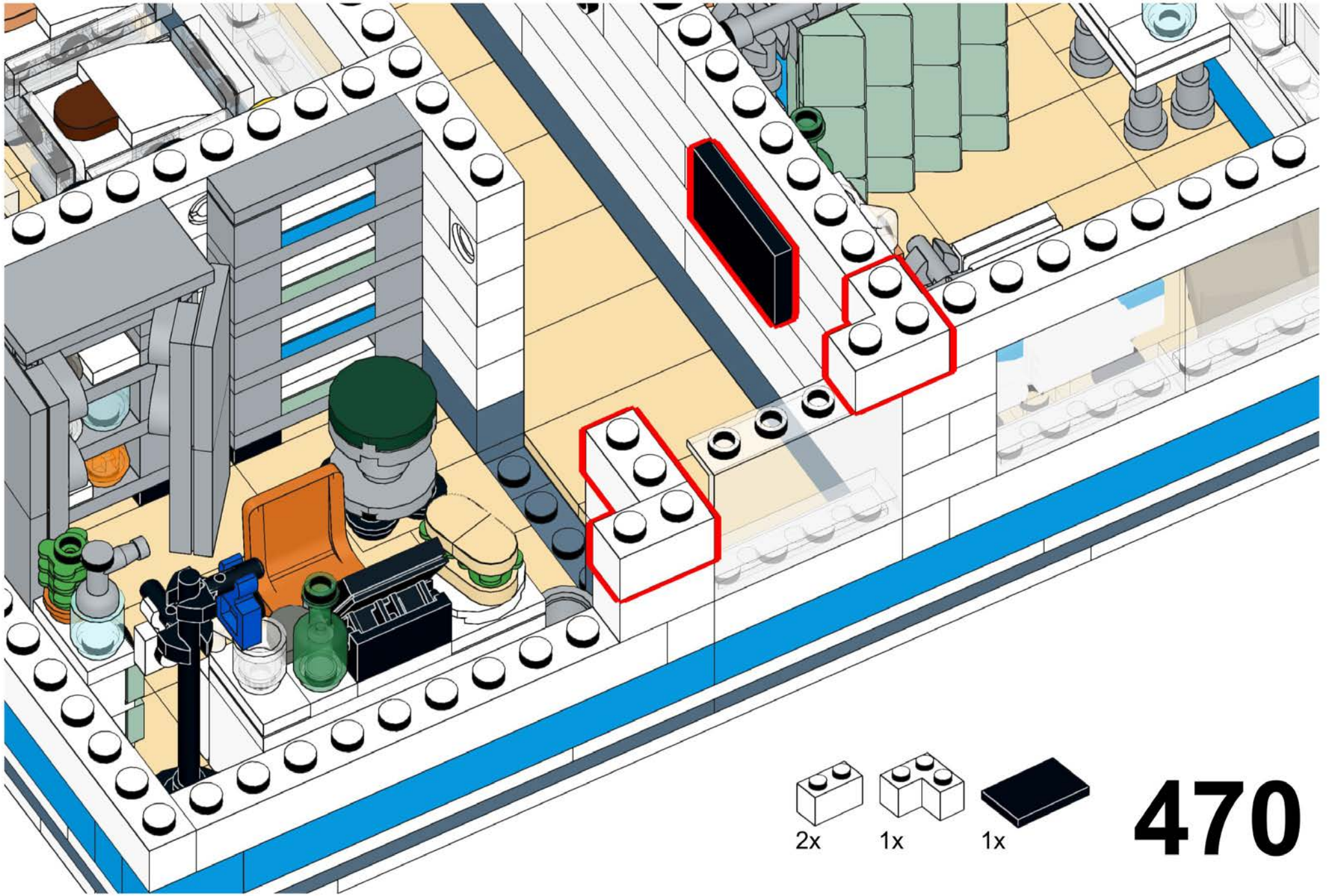

2x

1x

1x

470

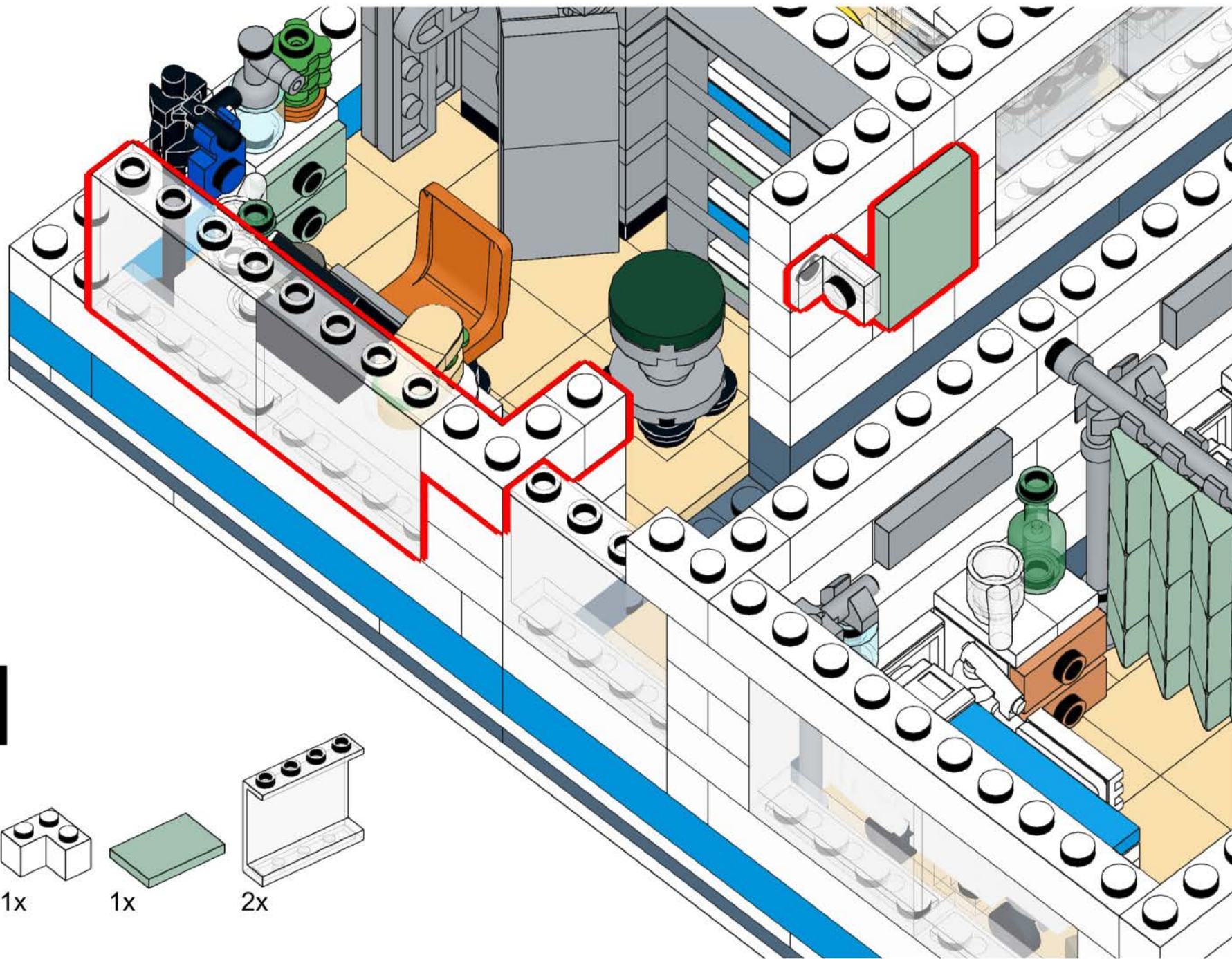

# 471

- 1x
- 1x
- 1x
- 1x
- 2x

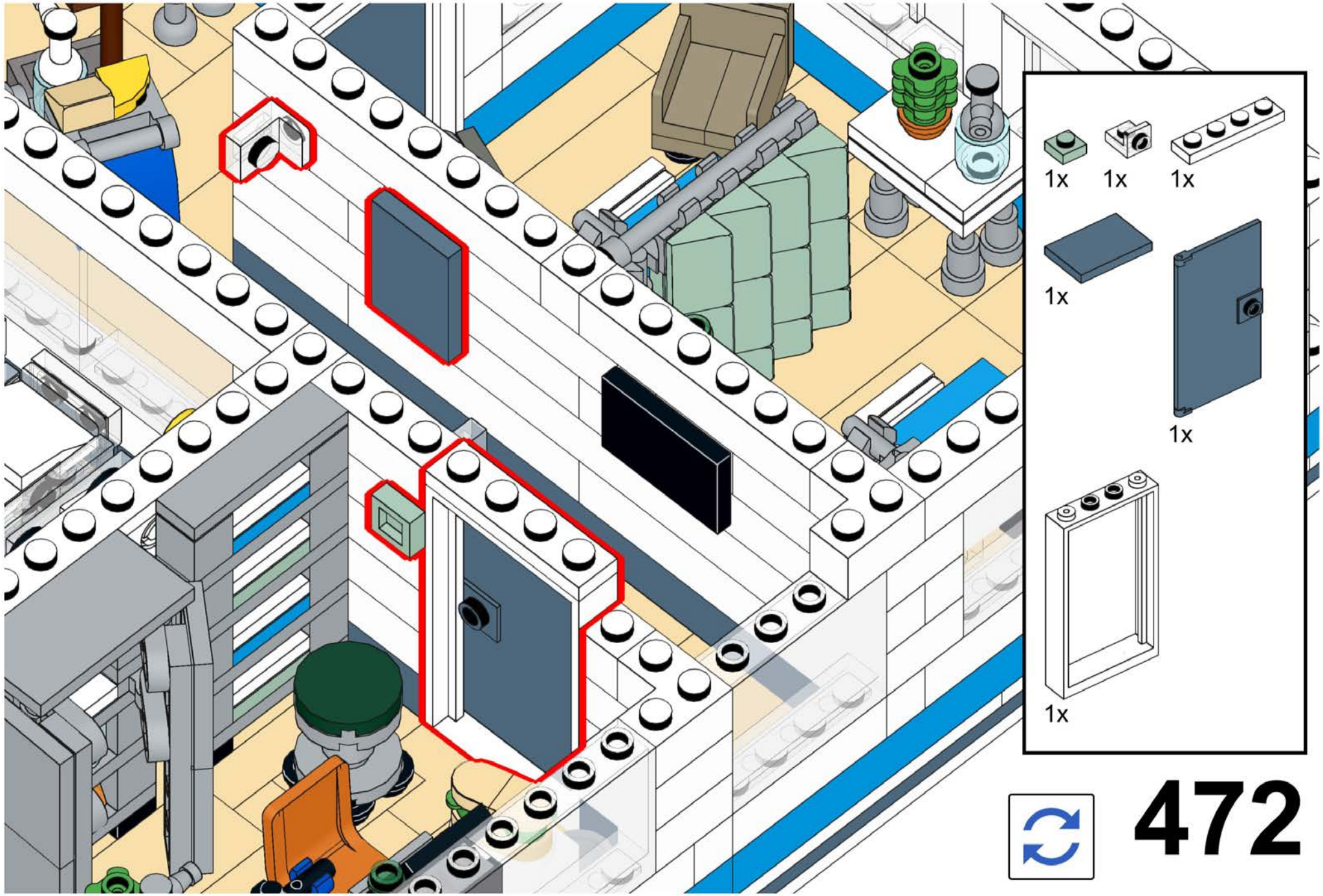

- 1x
- 1x
- 1x
- 1x
- 1x
- 1x



472

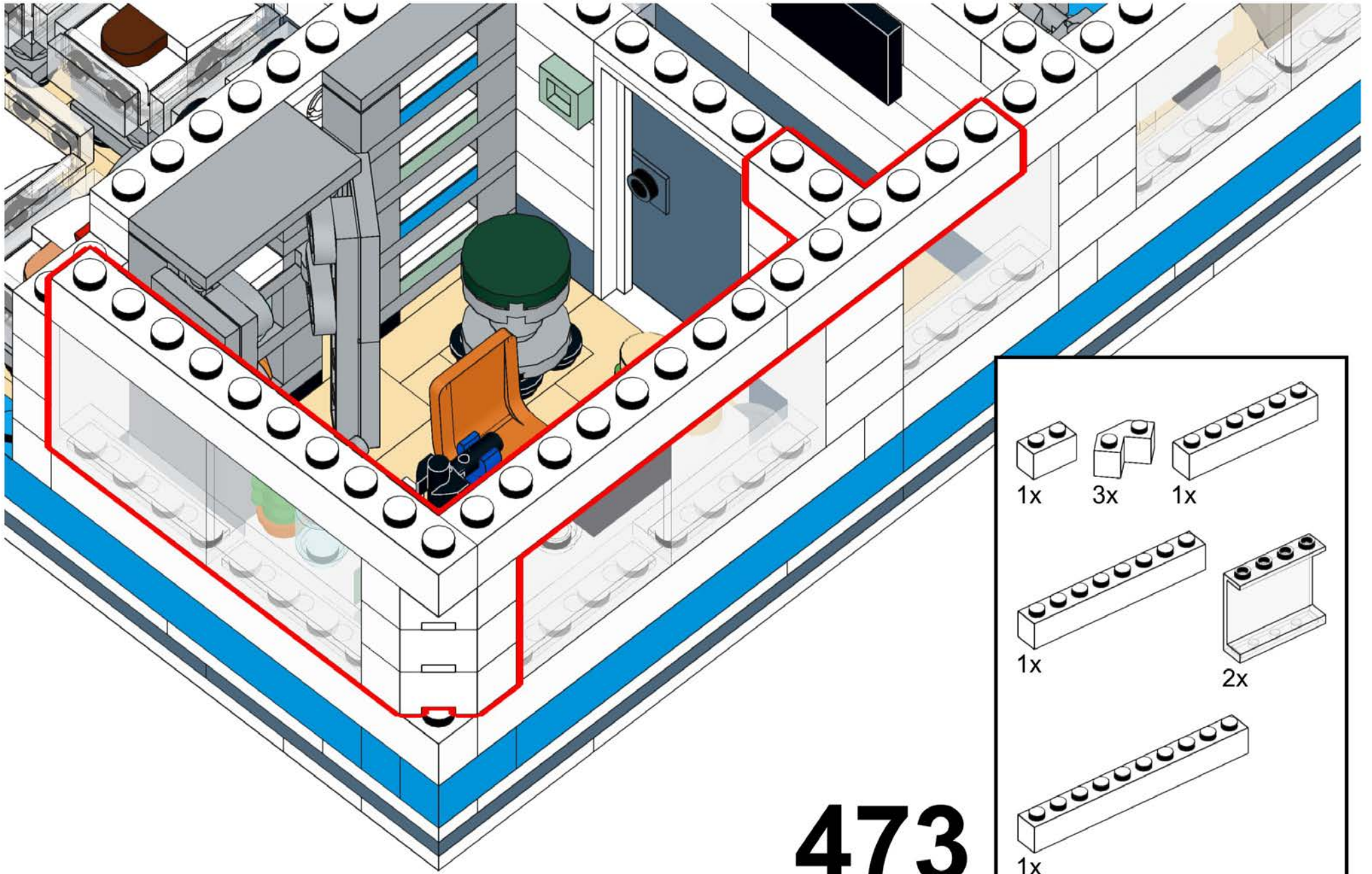

473

- 1x 1x2 brick
- 3x 1x2 brick with hole
- 1x 1x6 brick
- 1x 1x6 brick with hole
- 2x 1x4 brick with hole
- 1x 1x6 brick

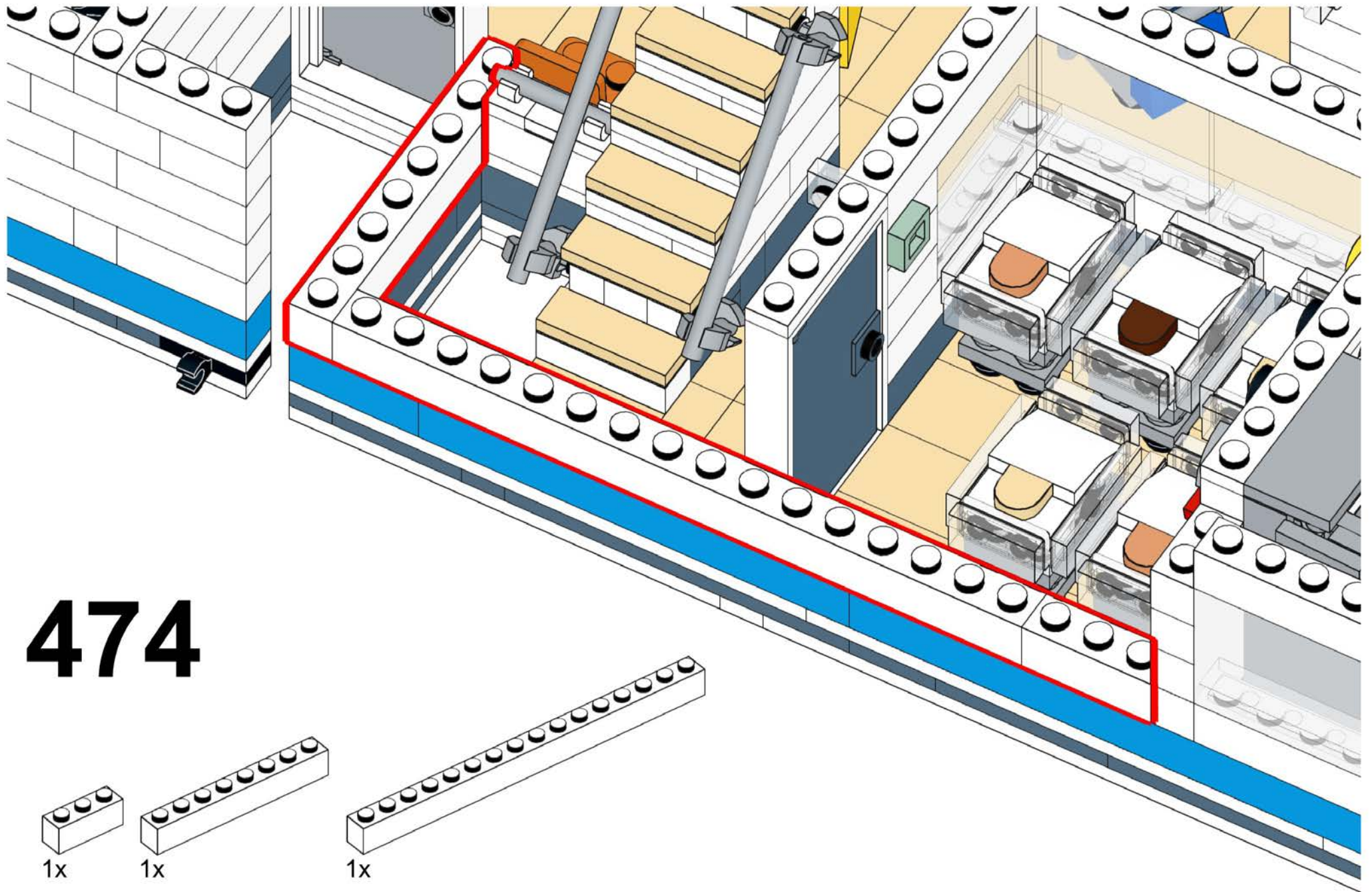



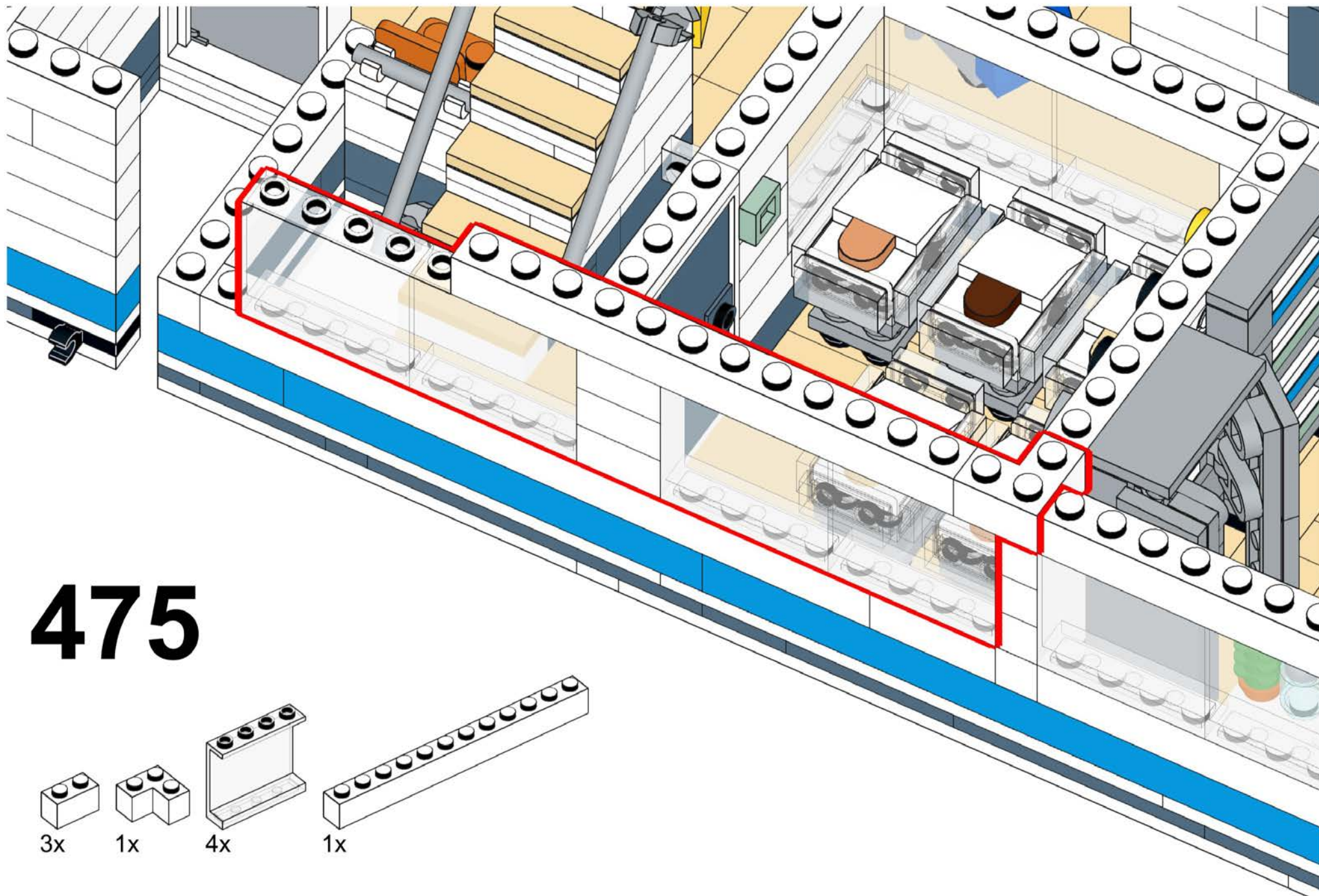

475

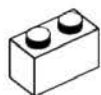

3x

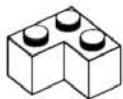

1x



4x

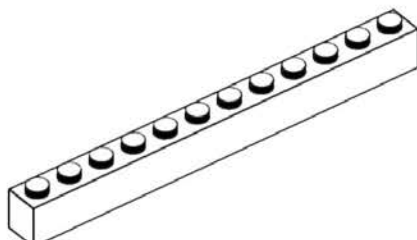

1x

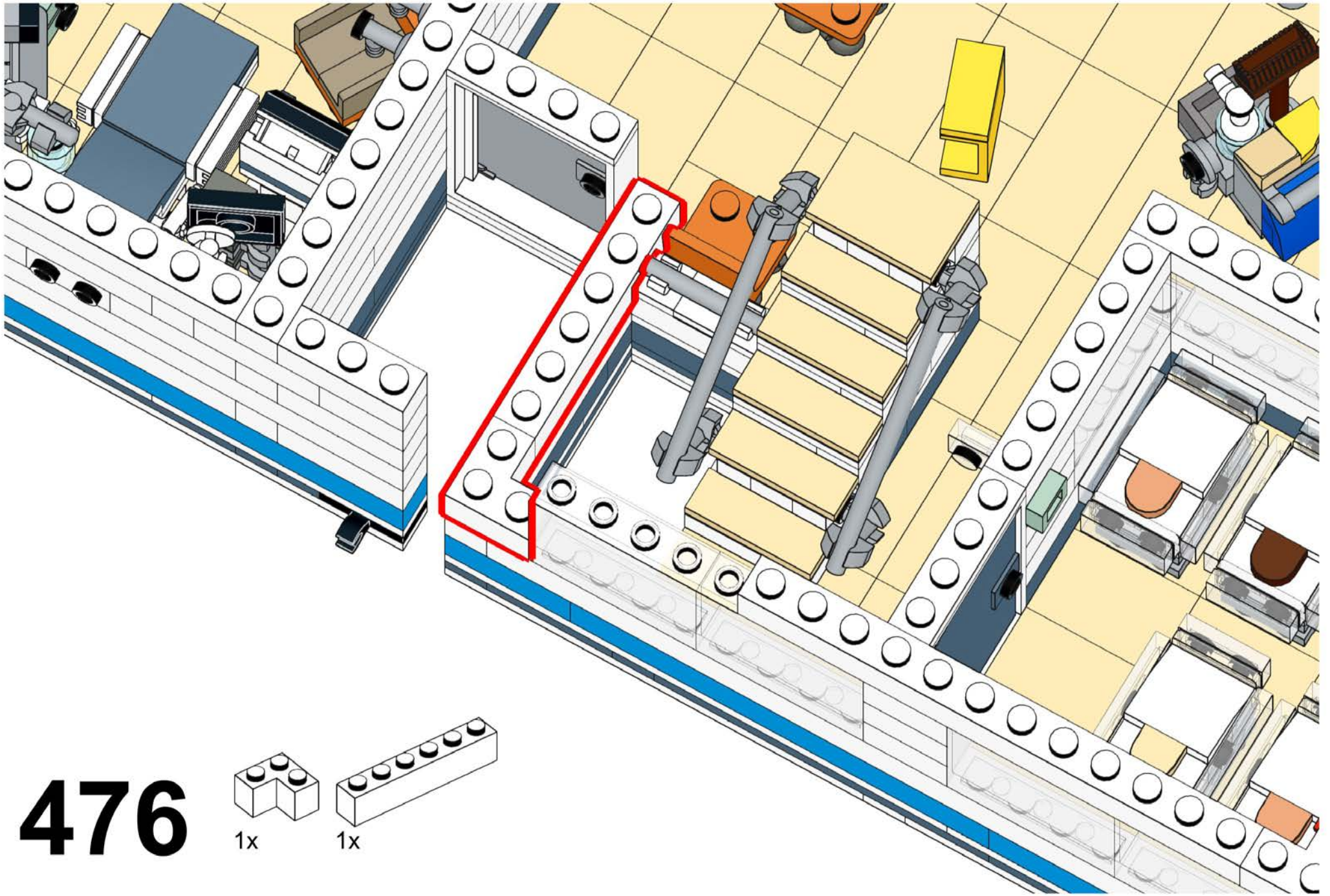

**476**

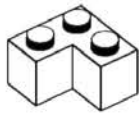

1x

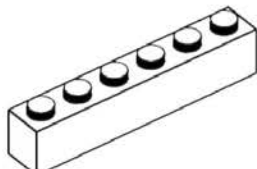

1x

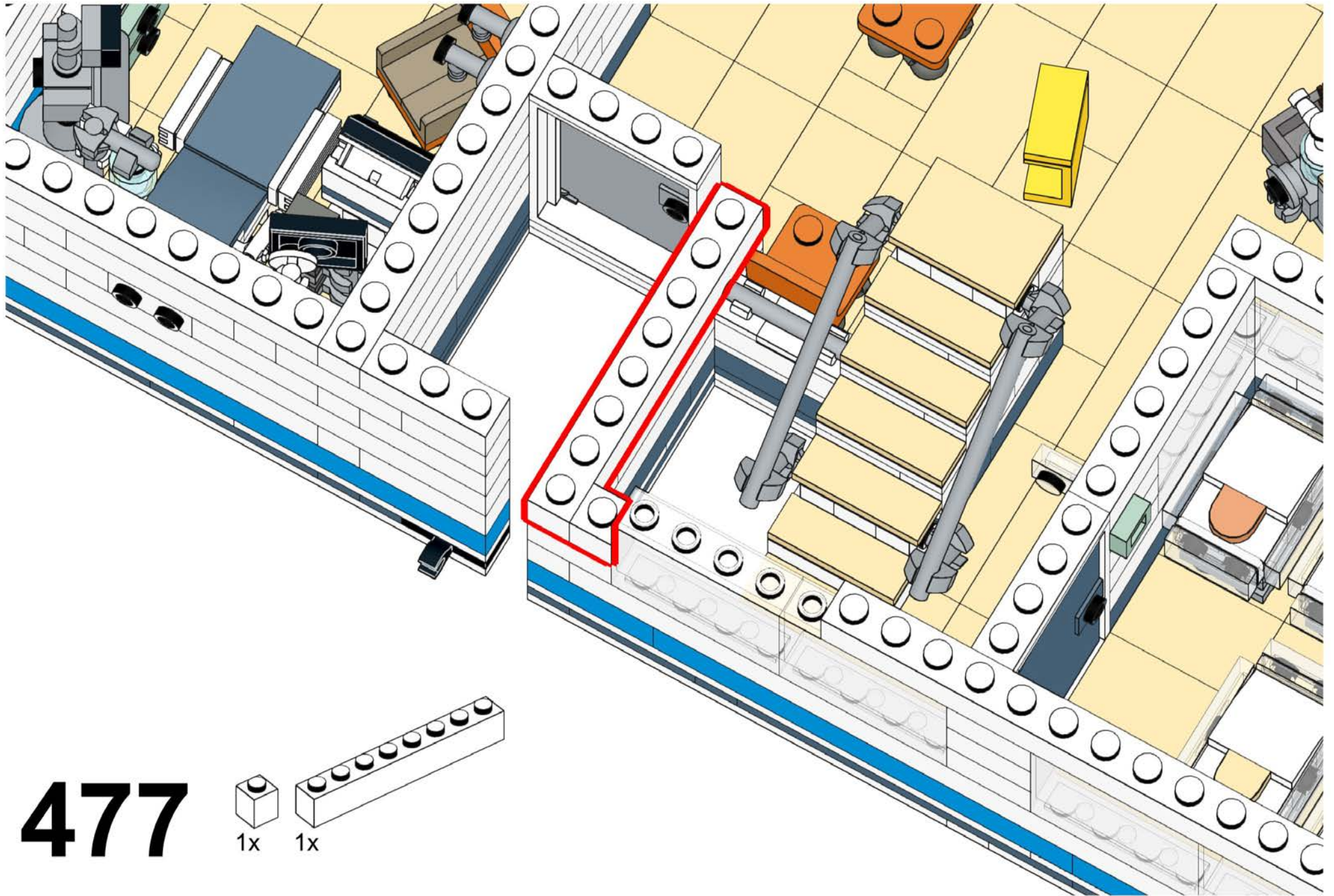

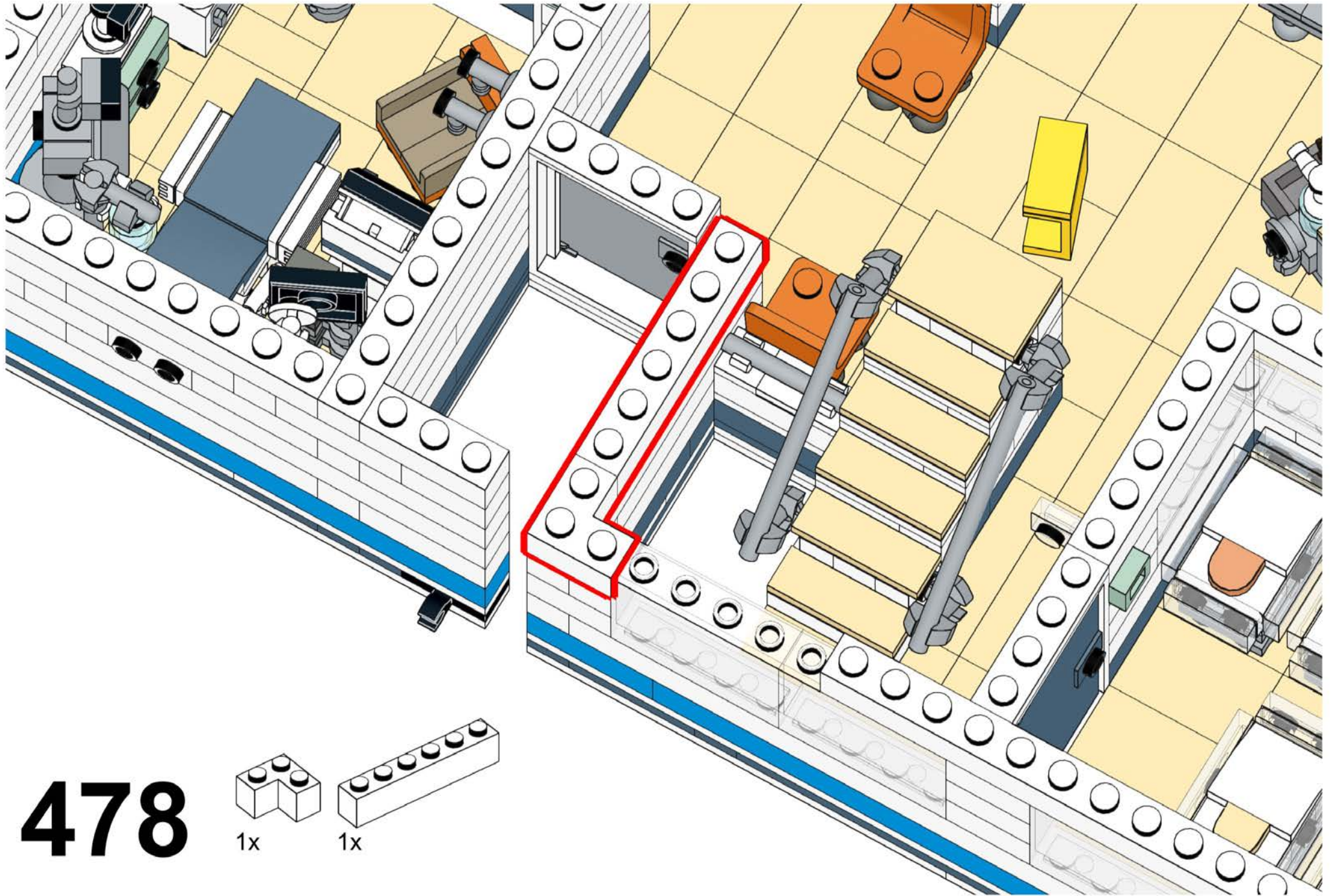

478

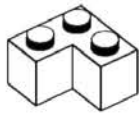

1x

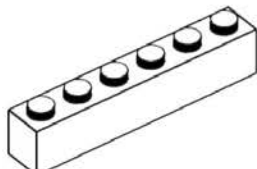

1x

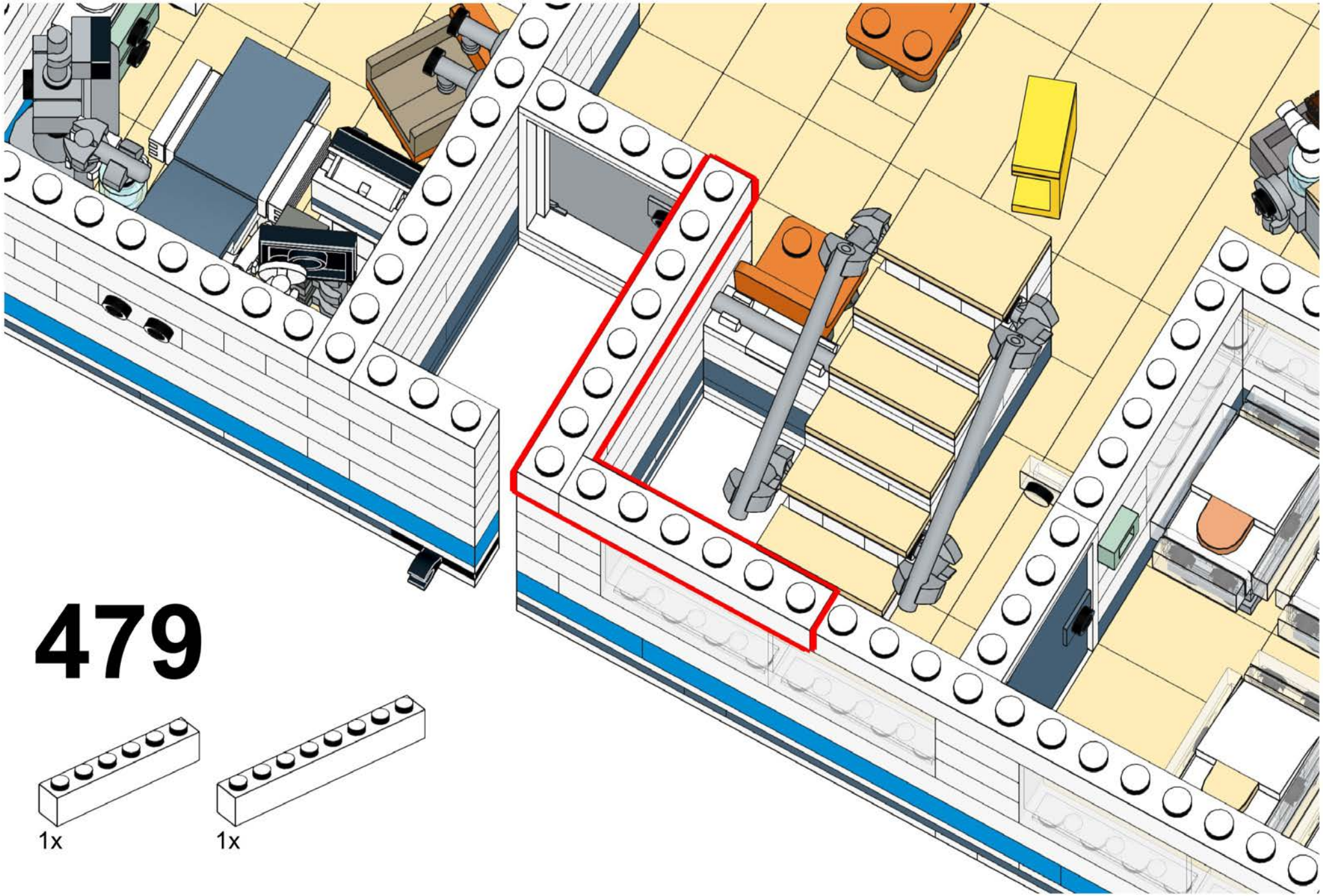

**479**

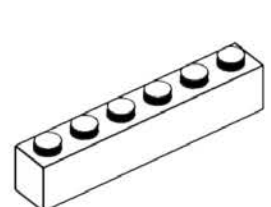

1x

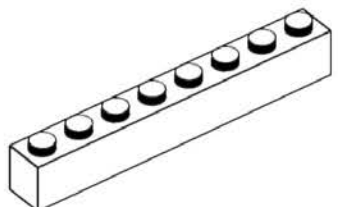

1x

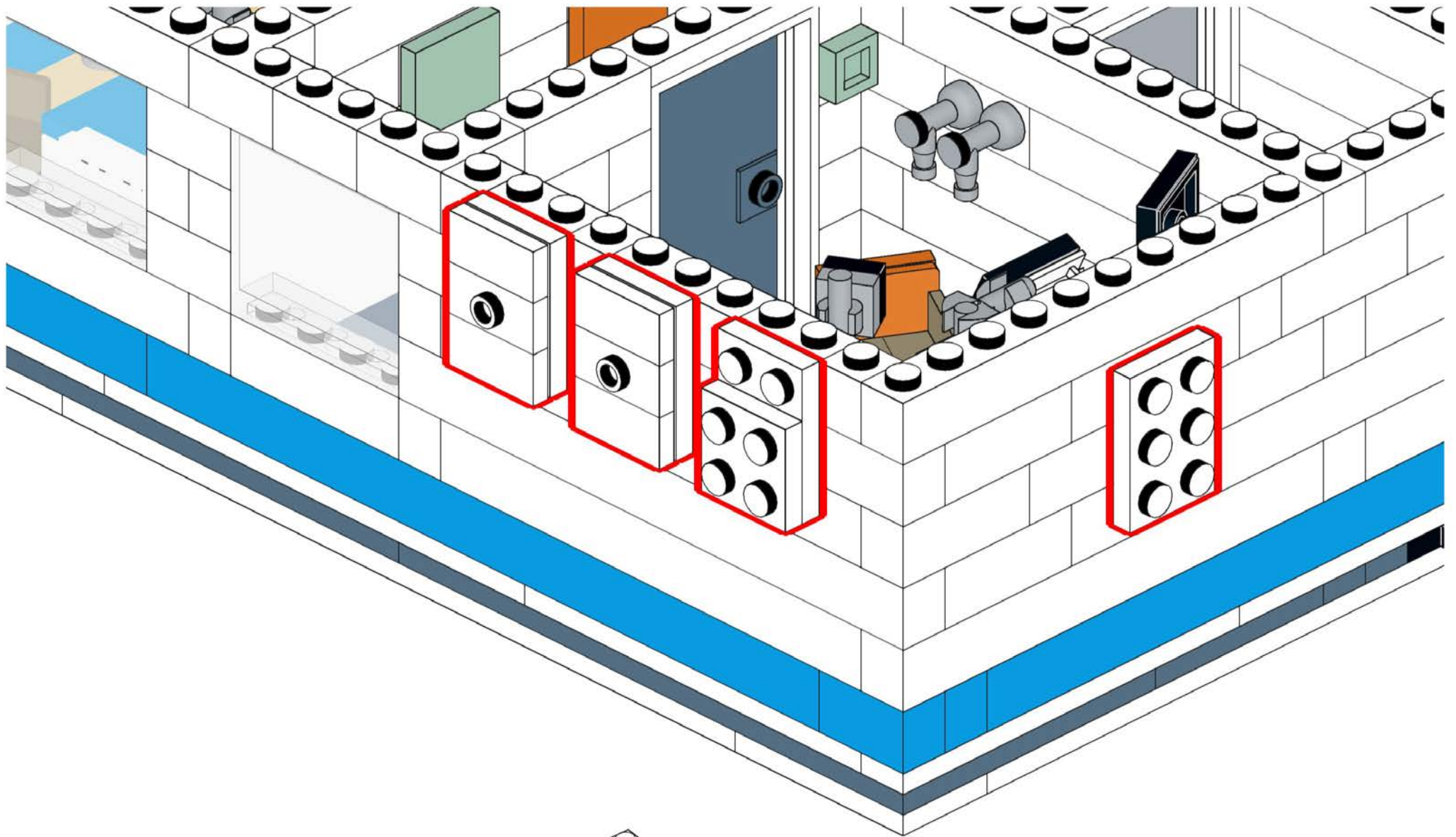

480

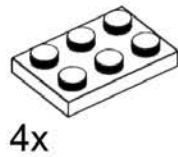
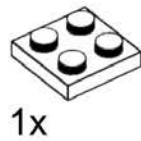
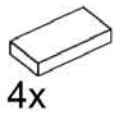

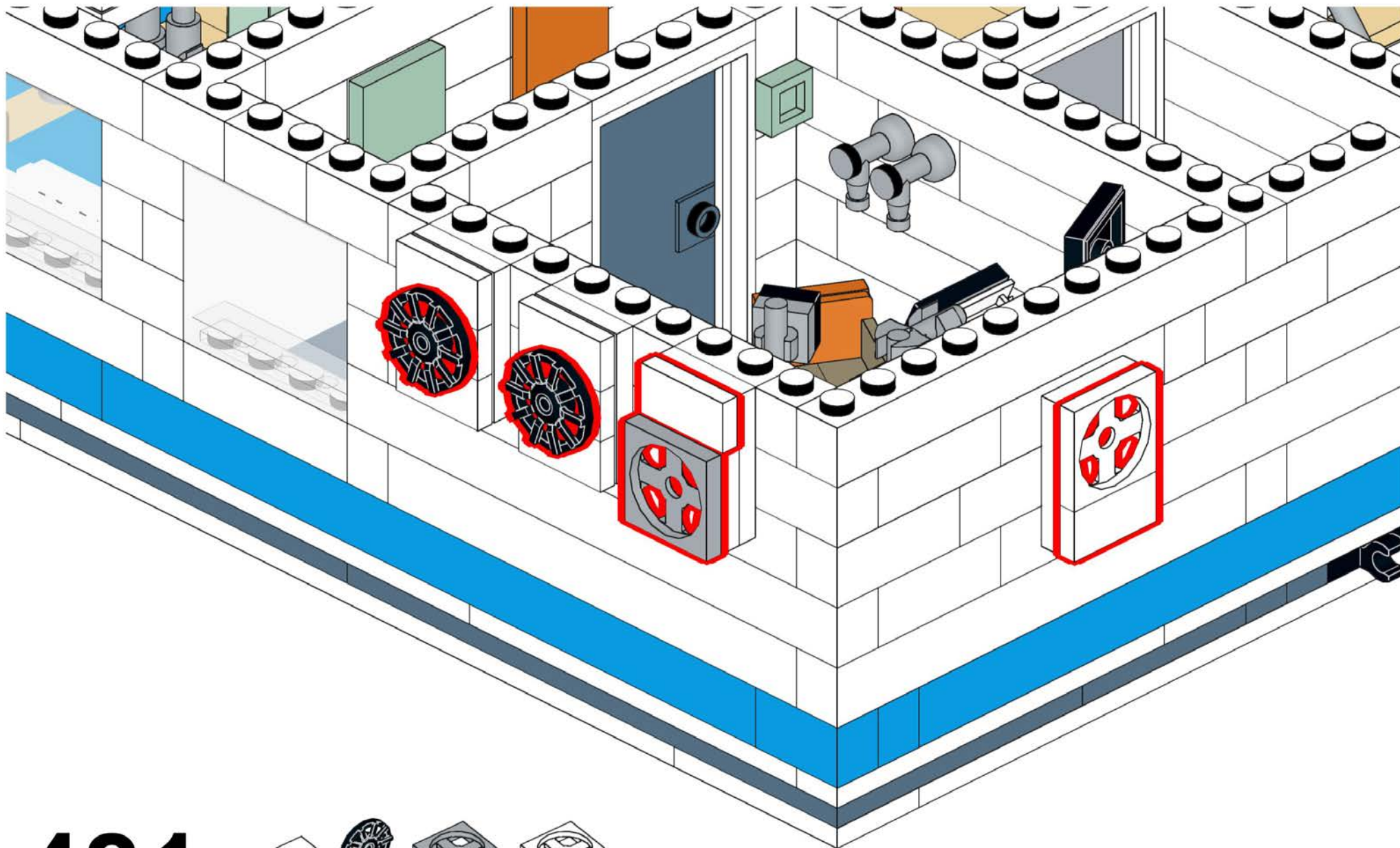

481

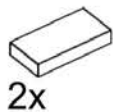

2x



2x



1x



1x

# 482

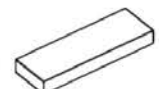
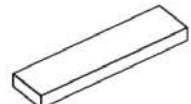
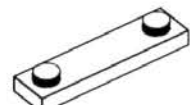
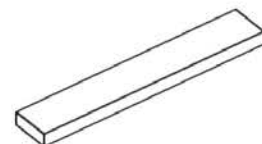
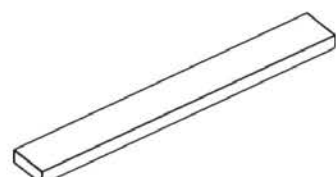
- 1x 
- 1x 
- 1x 
- 1x 
- 4x 
- 1x 

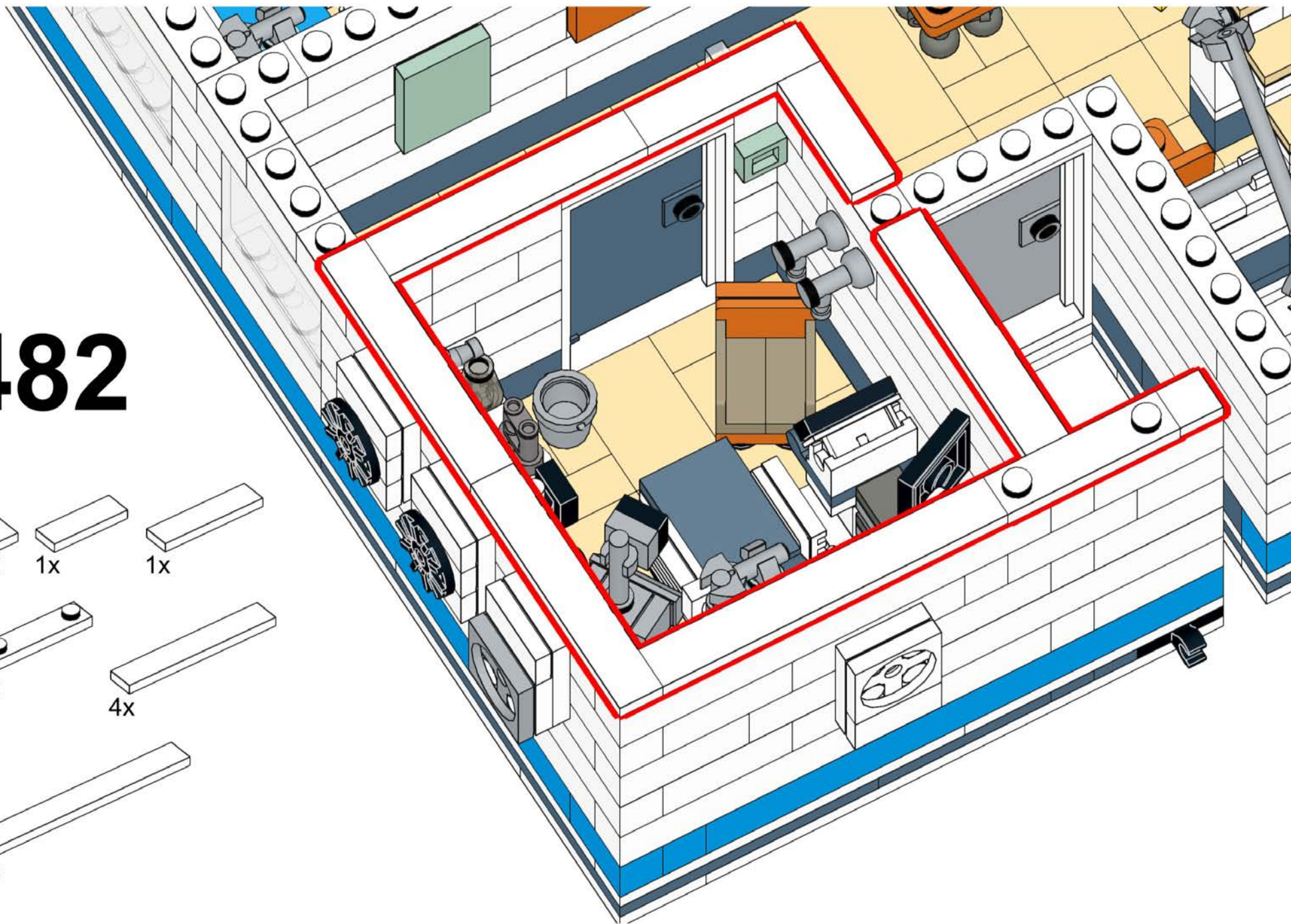



# 483

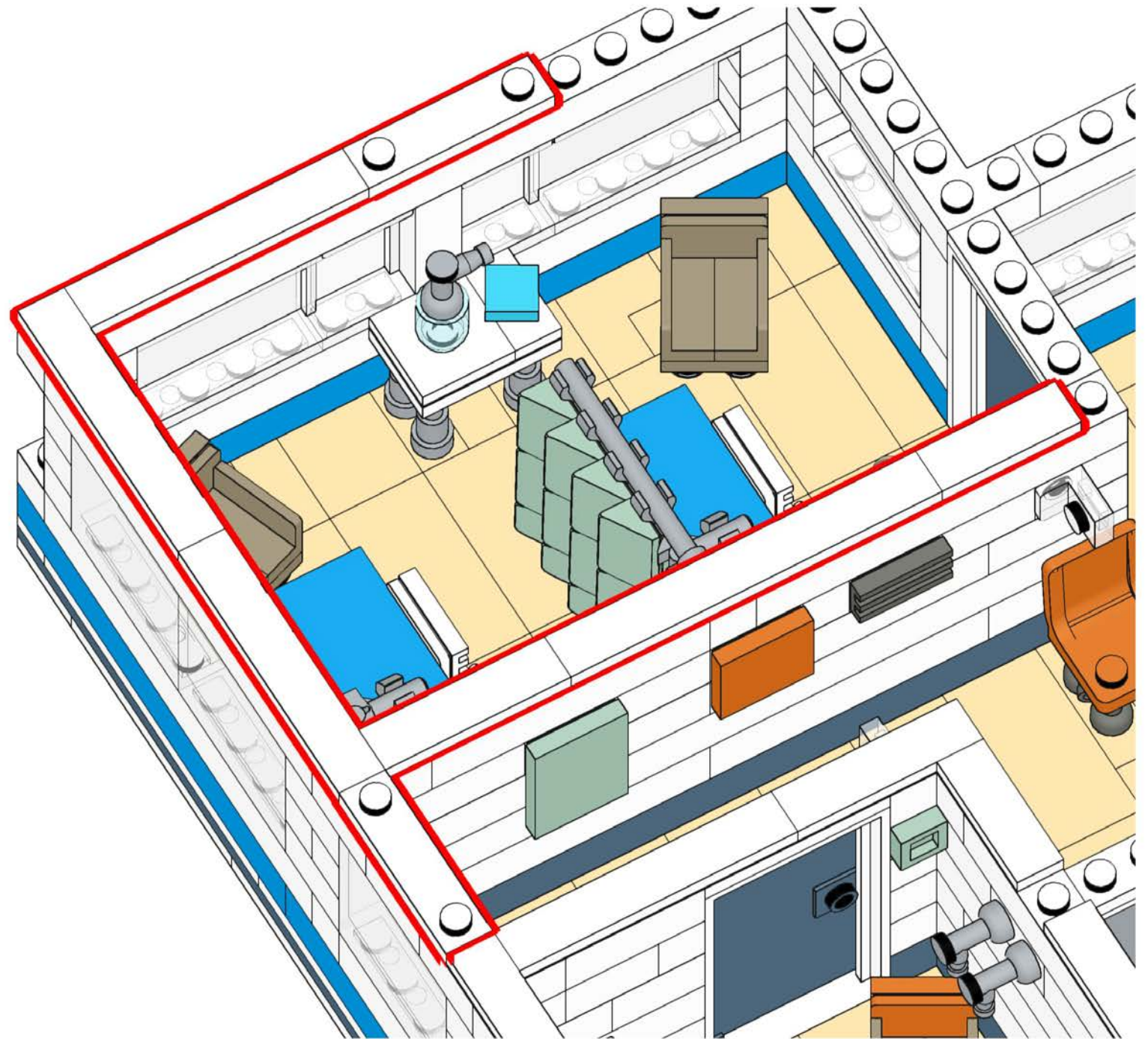
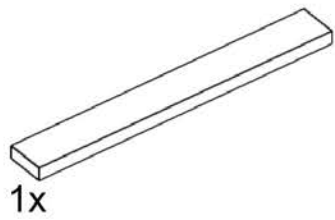
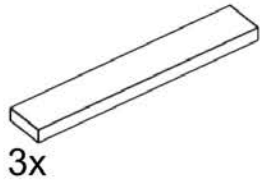
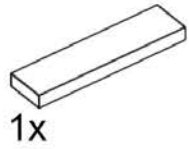
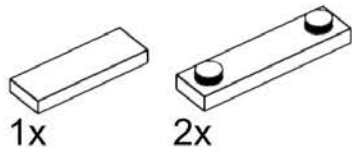

# 484

2x

2x

1x

2x

2x

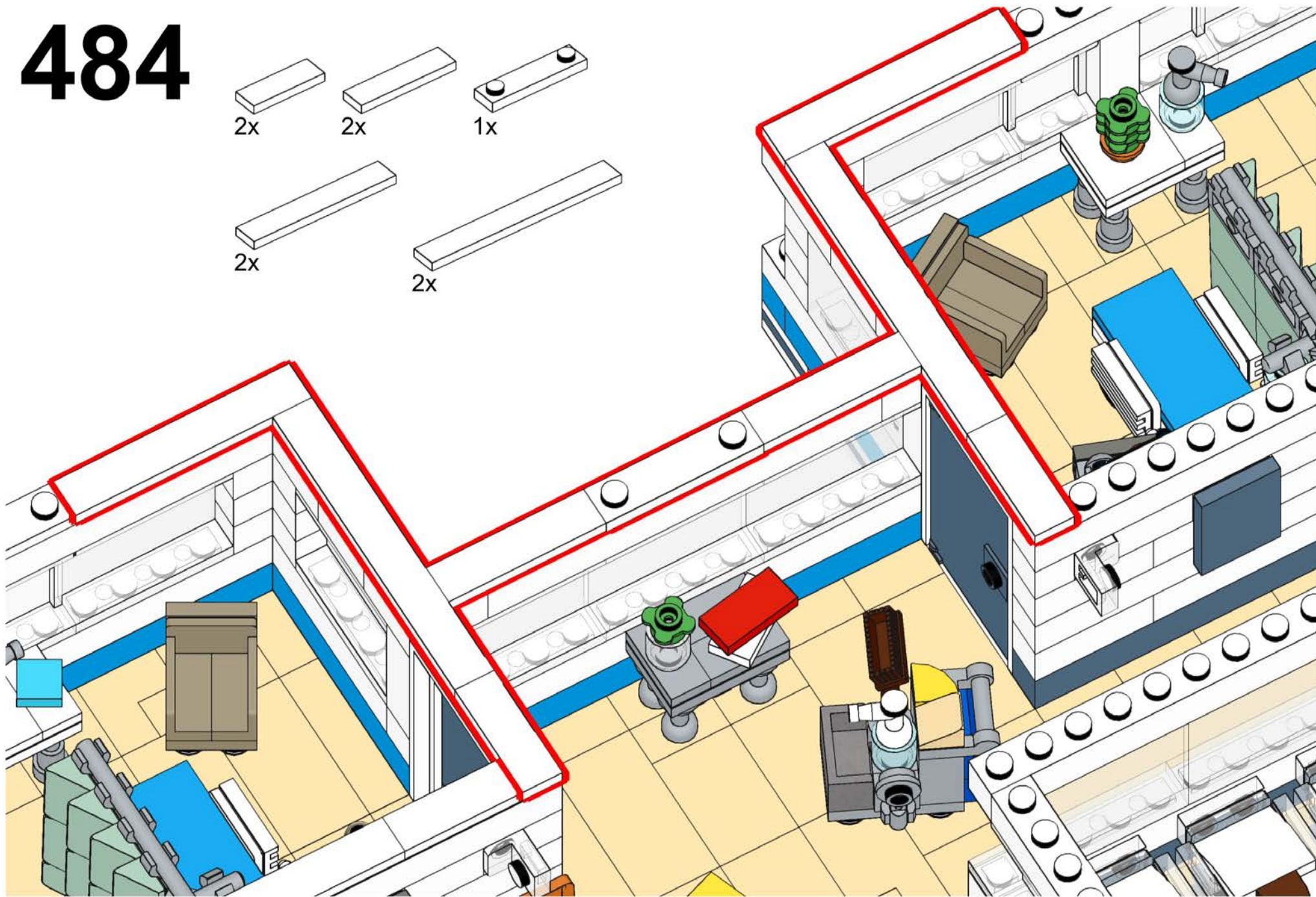

# 485

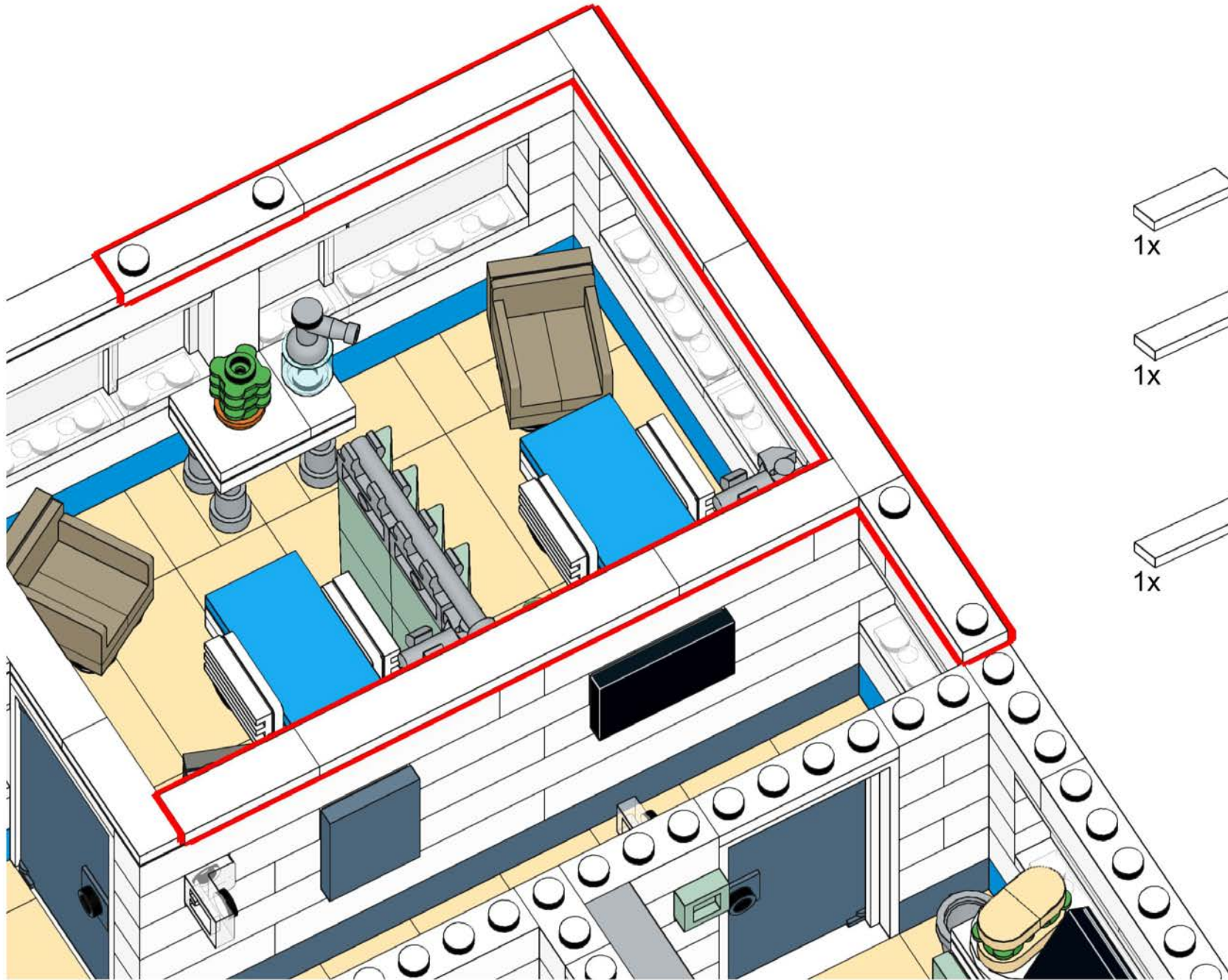

- 1x
- 2x
- 1x
- 3x
- 1x

# 486

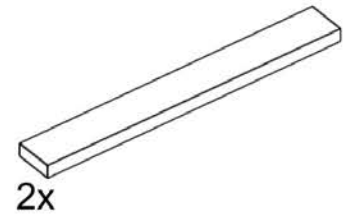
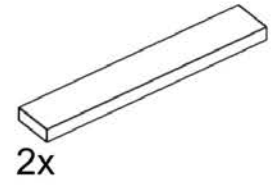
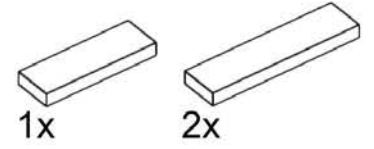
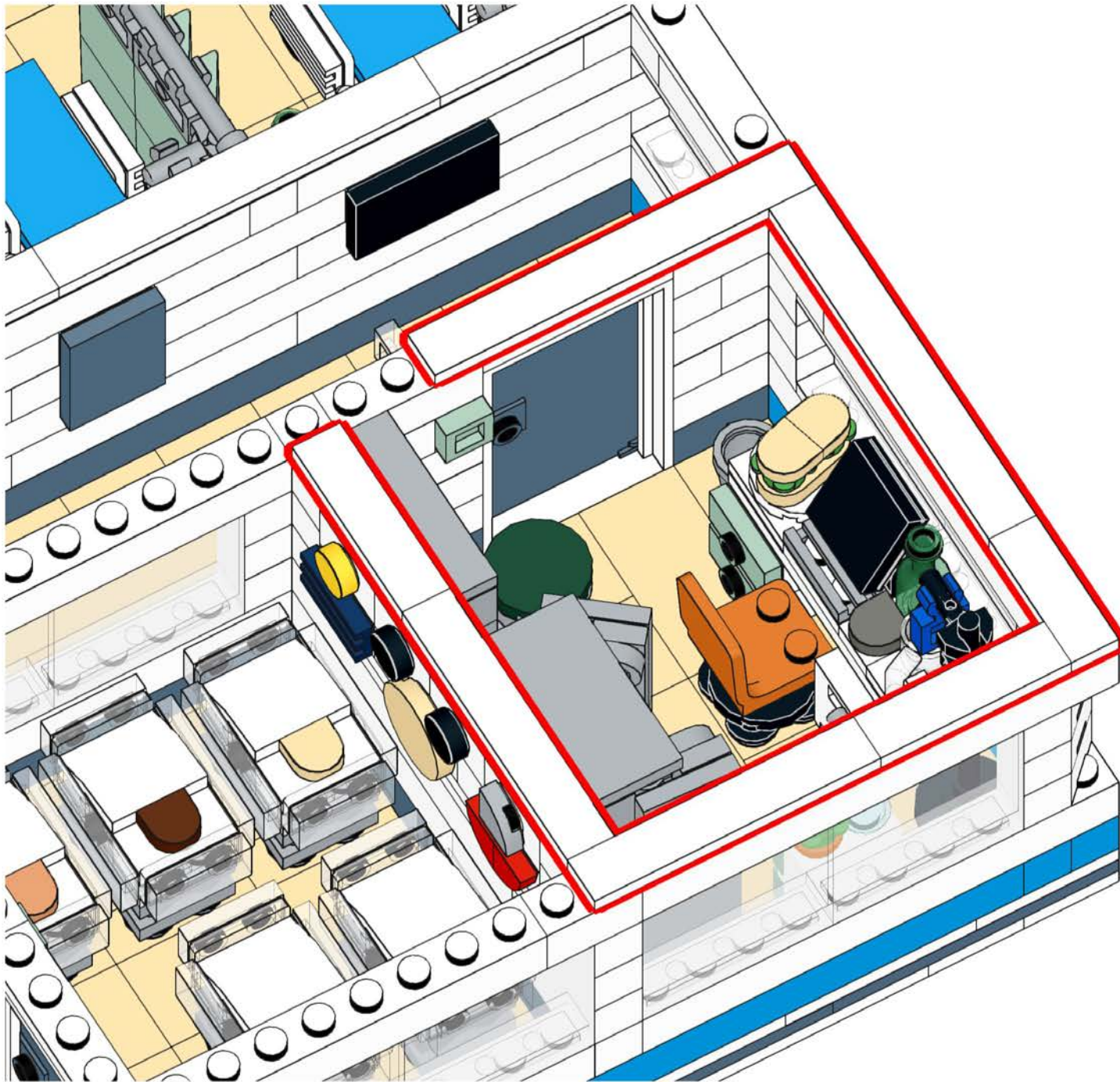

# 487

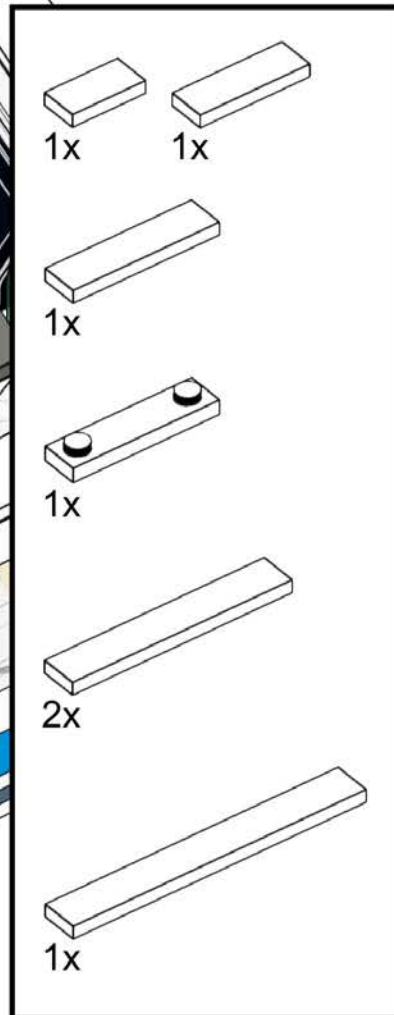
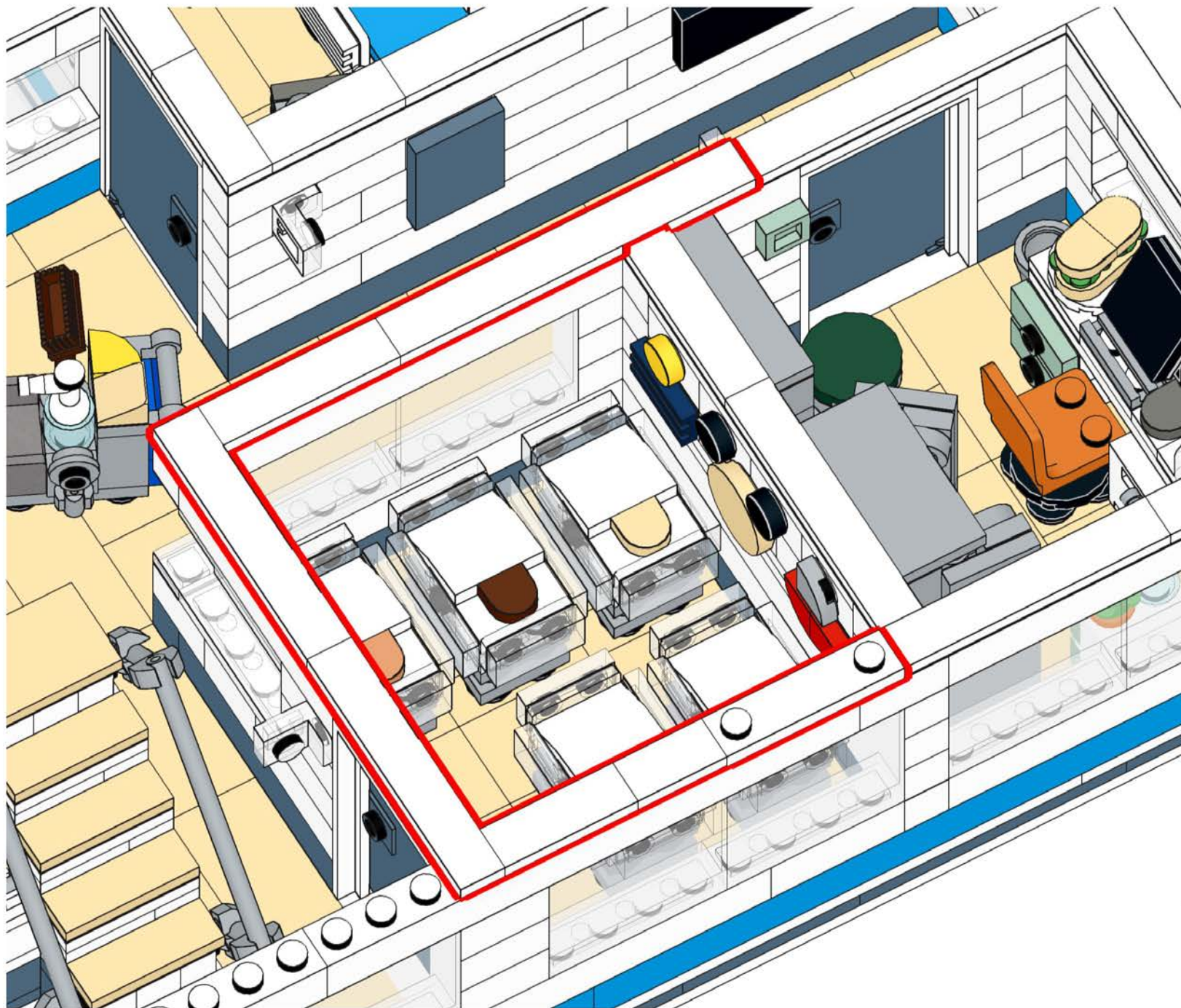

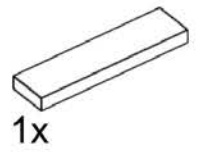
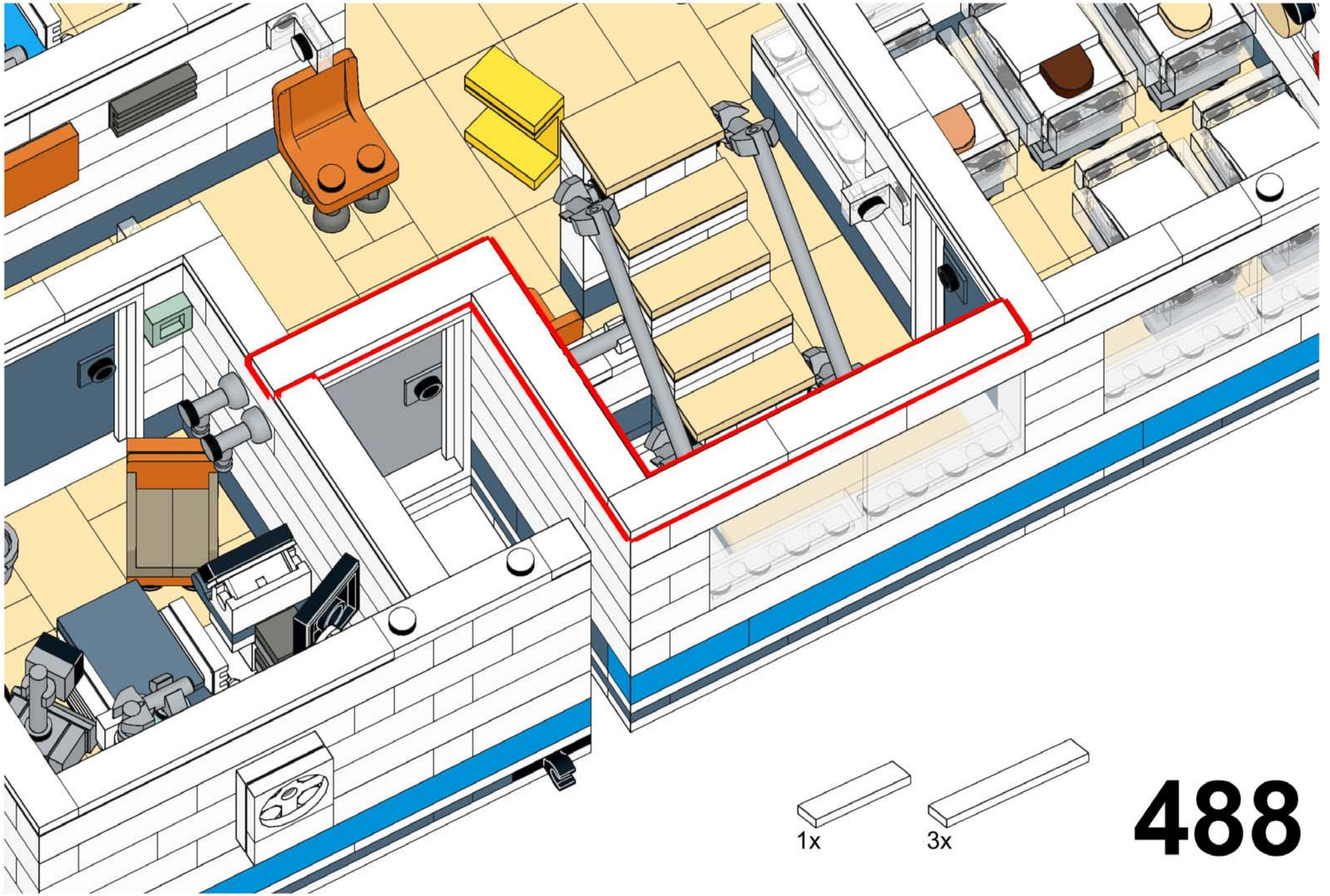

1x

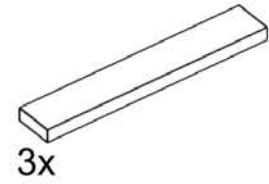

3x

# 488

# 489

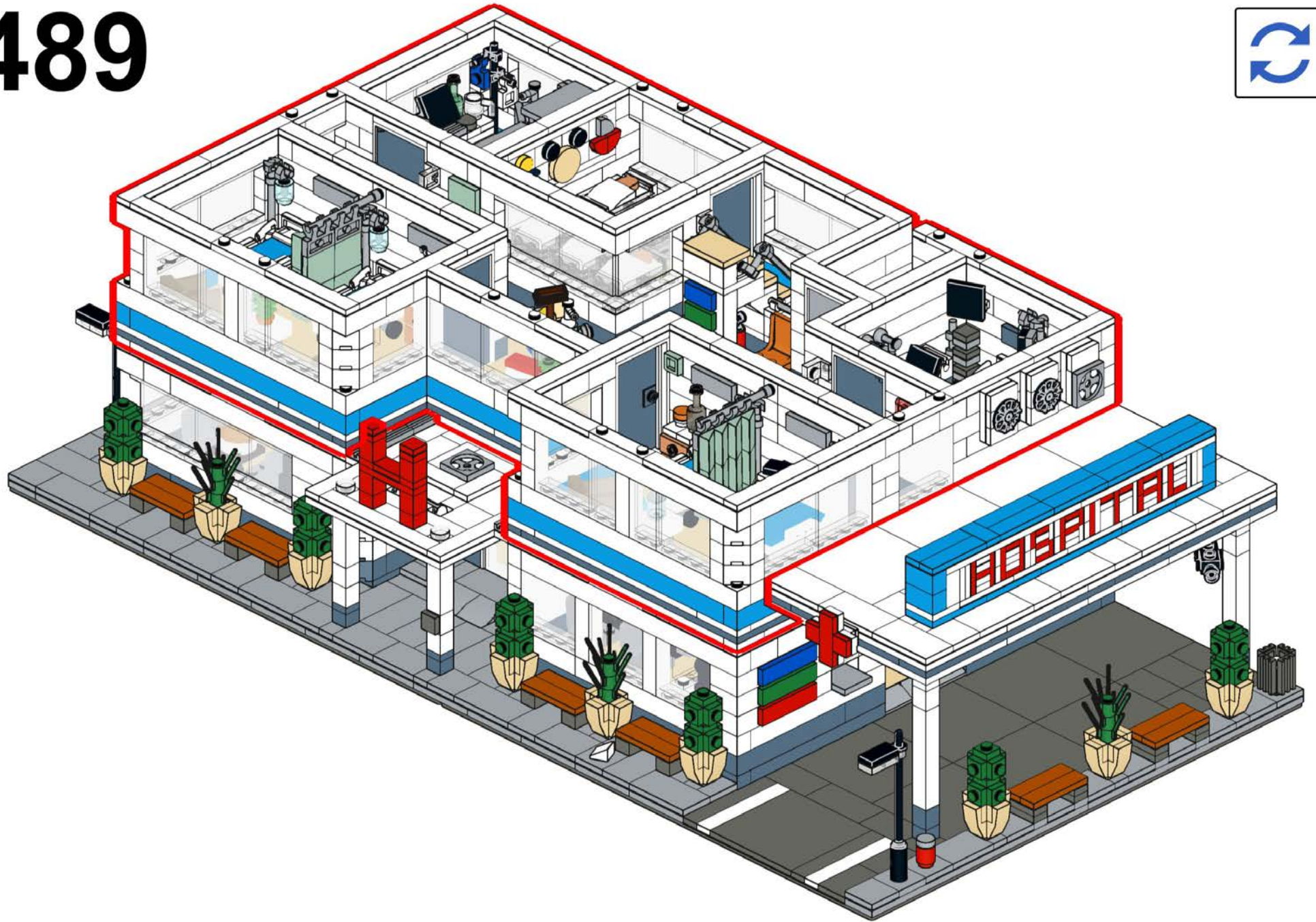

# 490

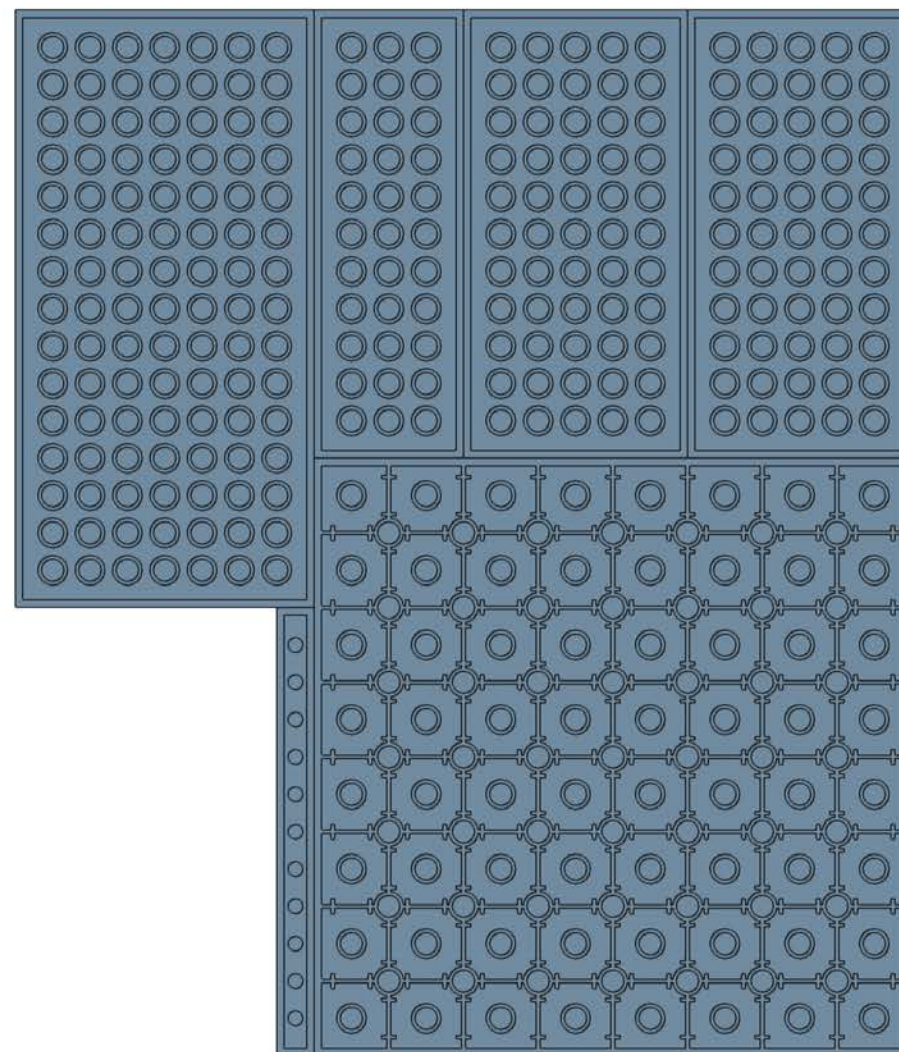
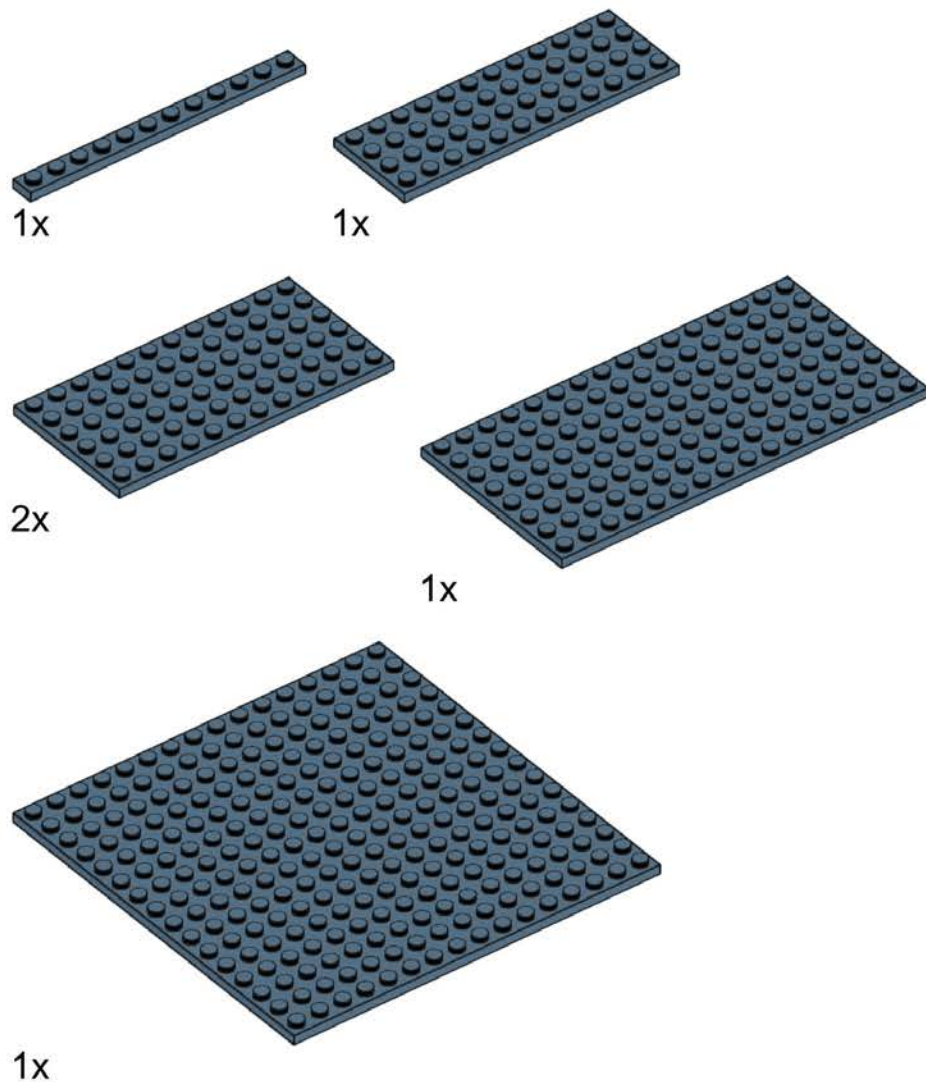
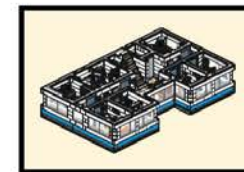



# 491

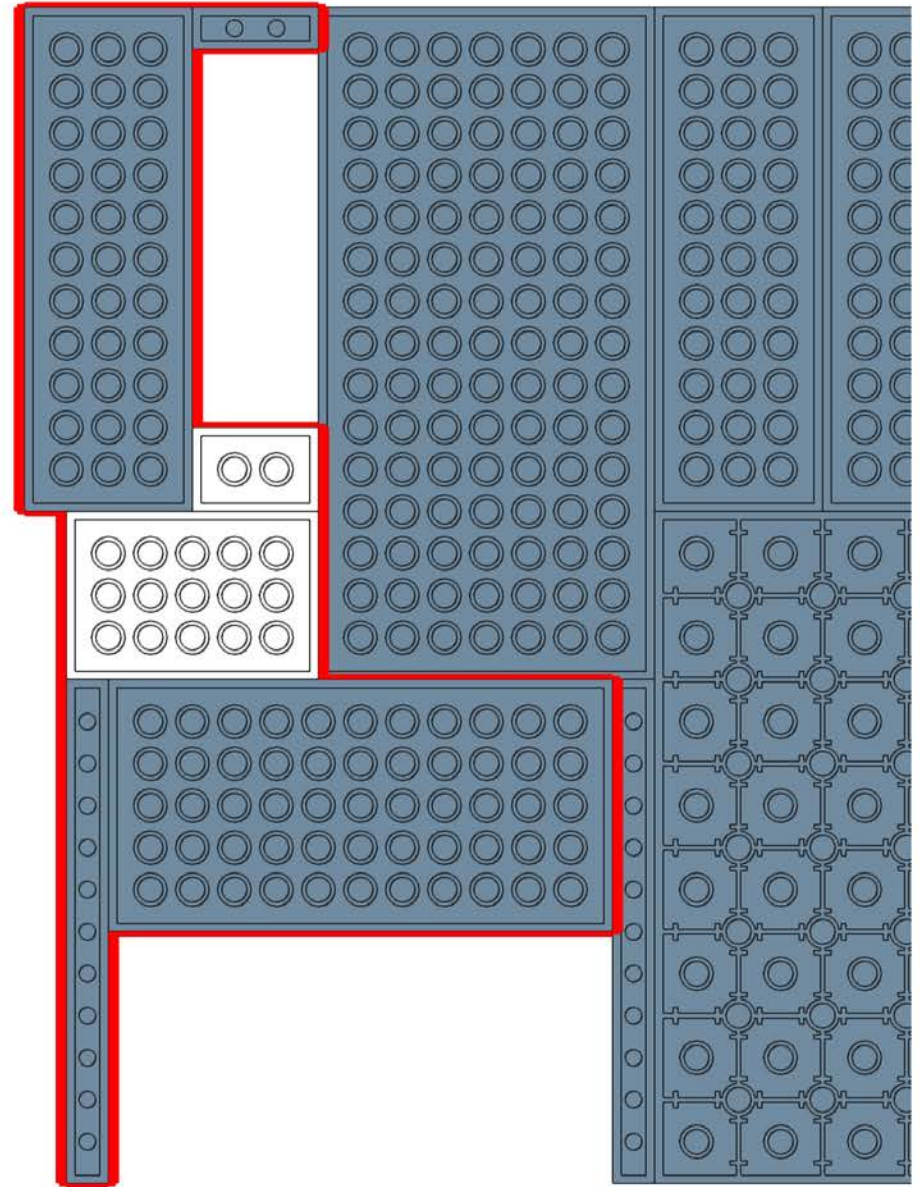
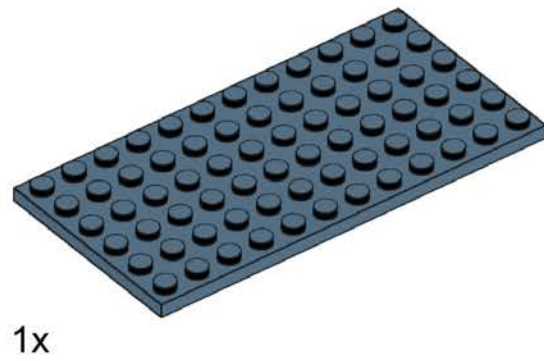
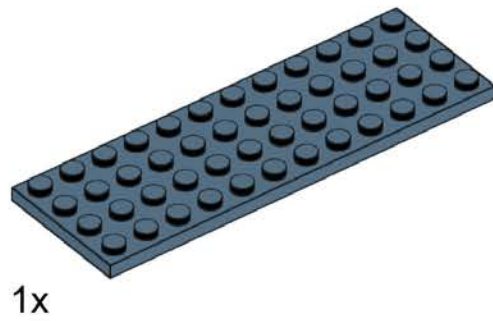
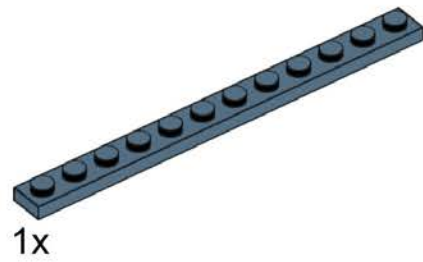
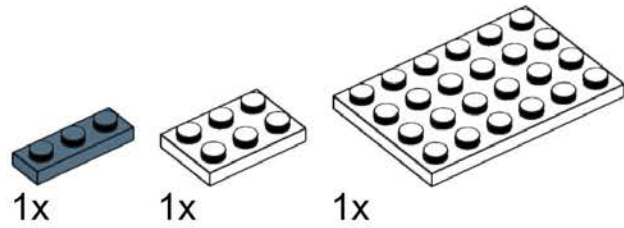

# 492

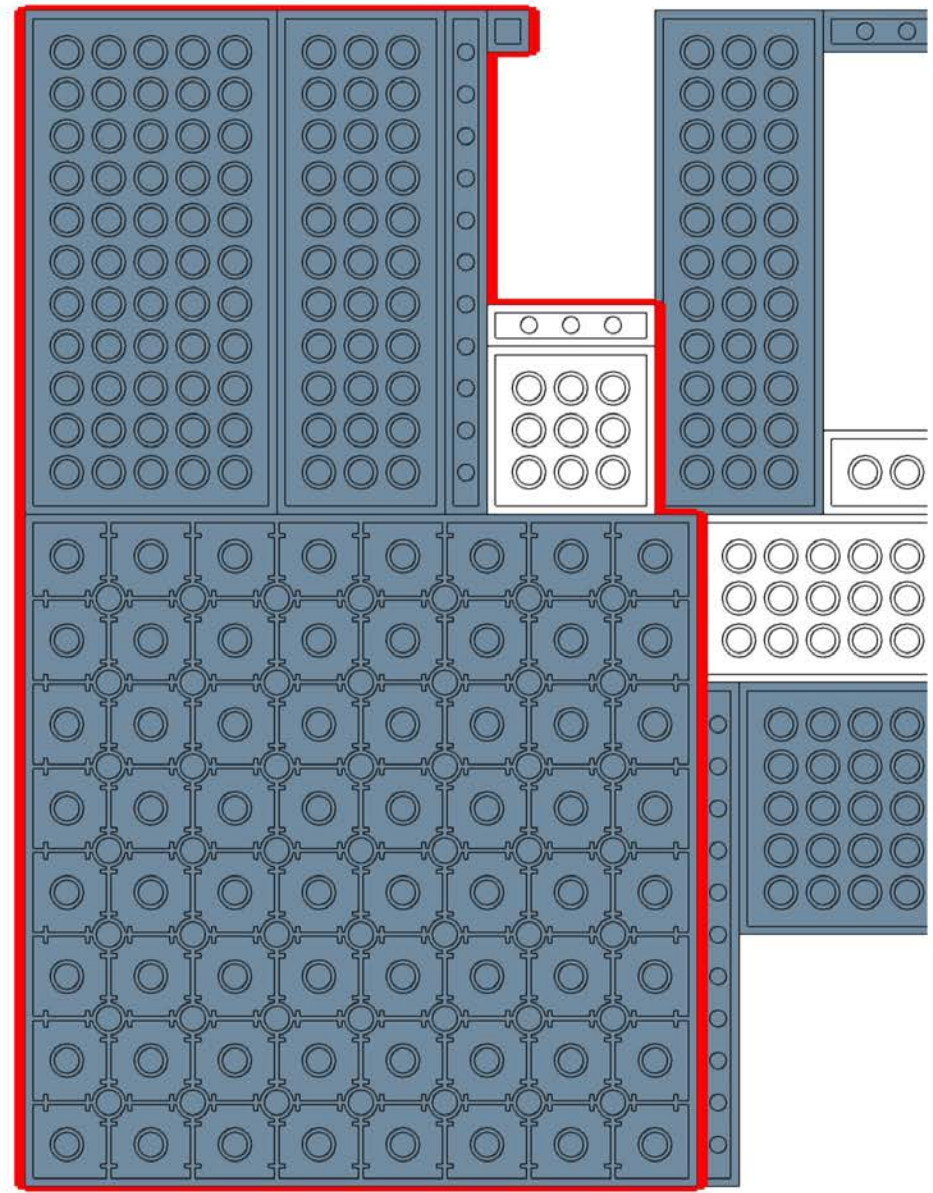
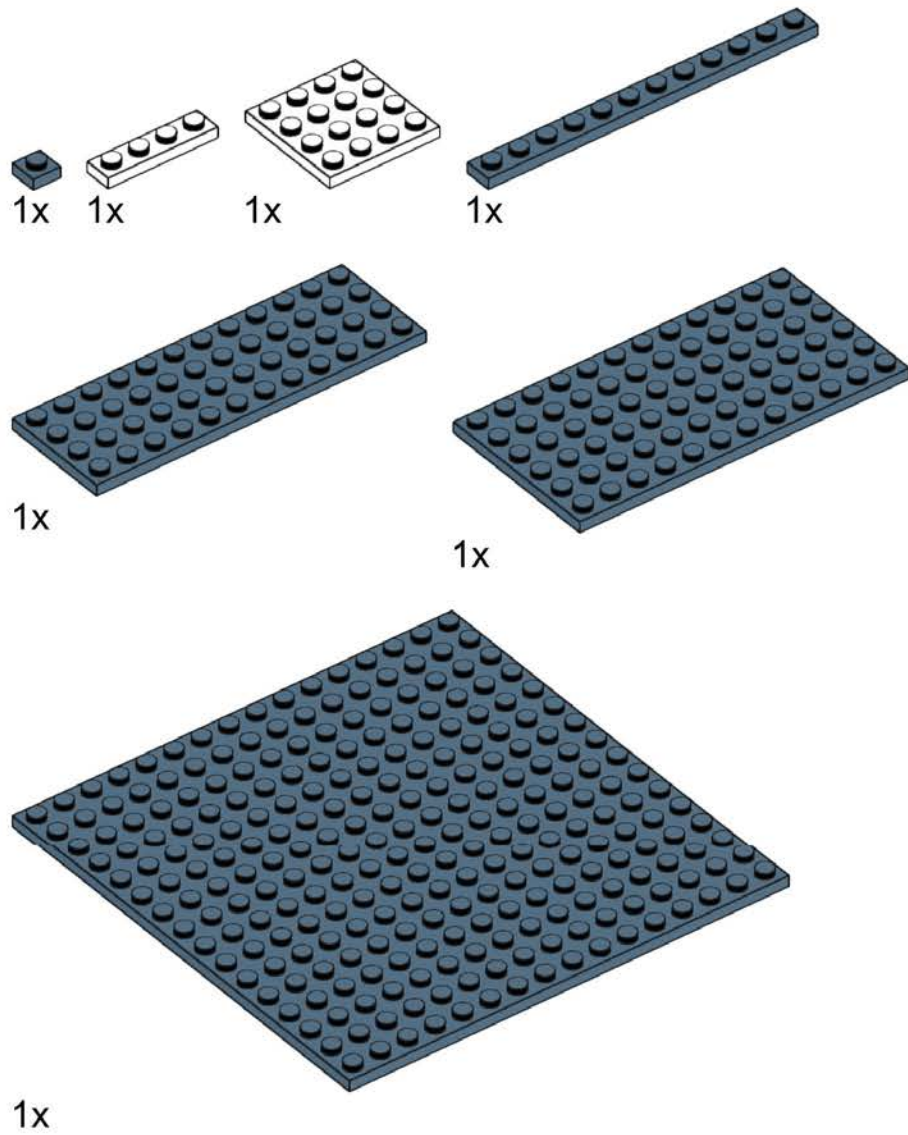

# 493

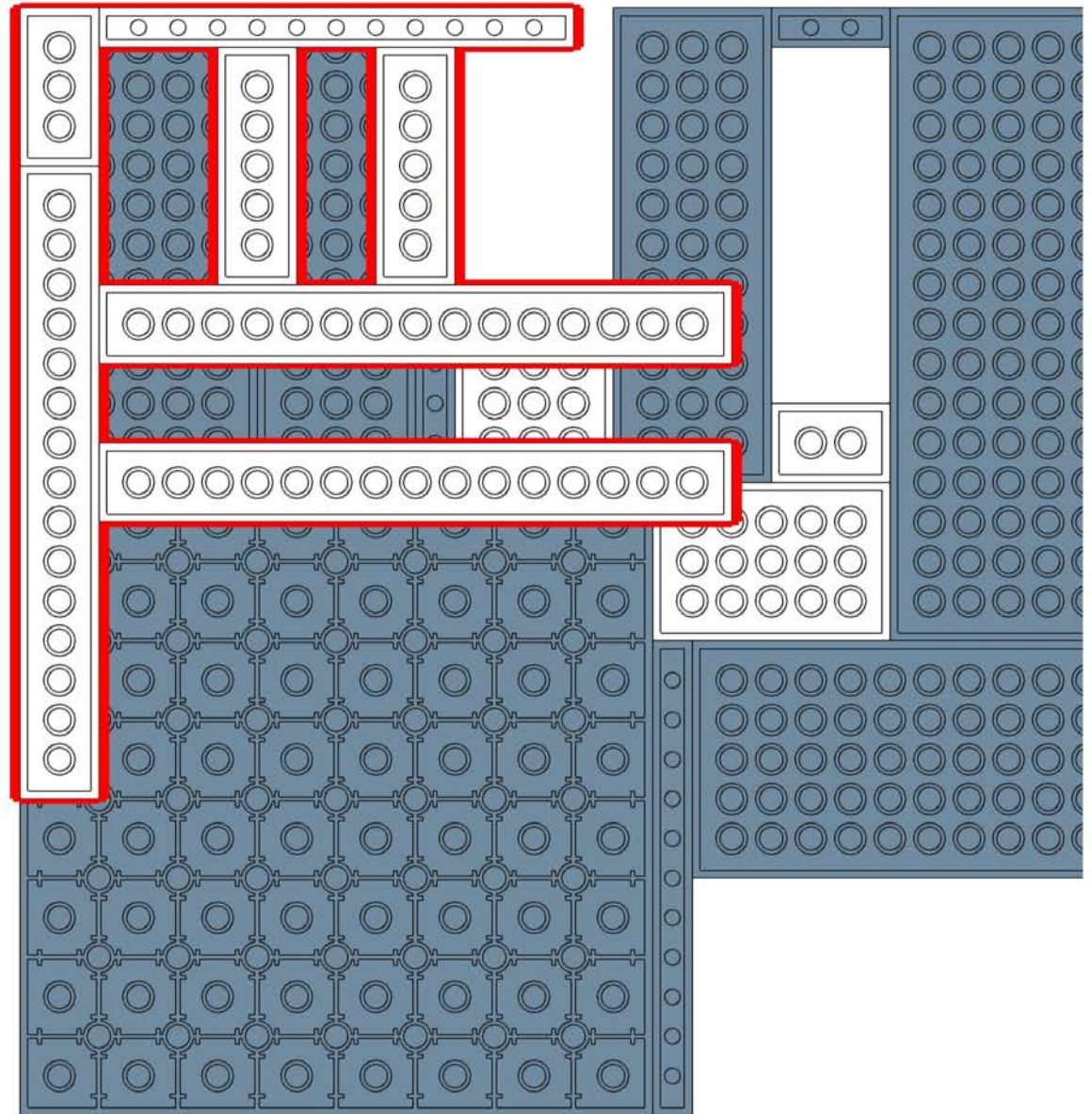
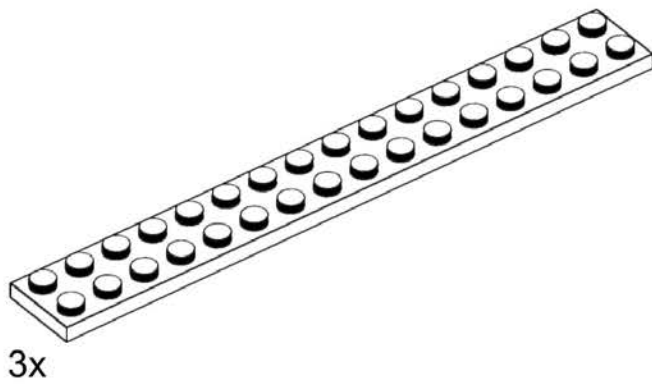
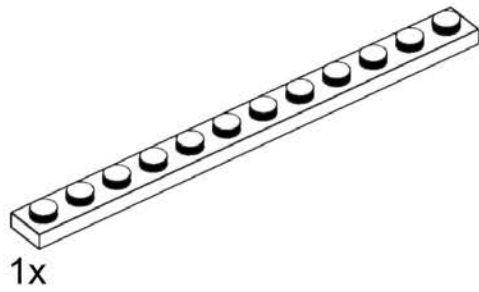
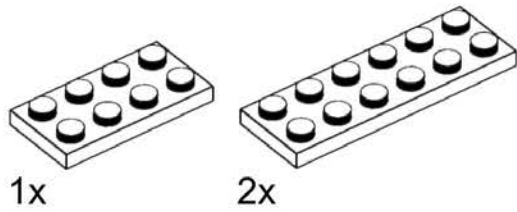

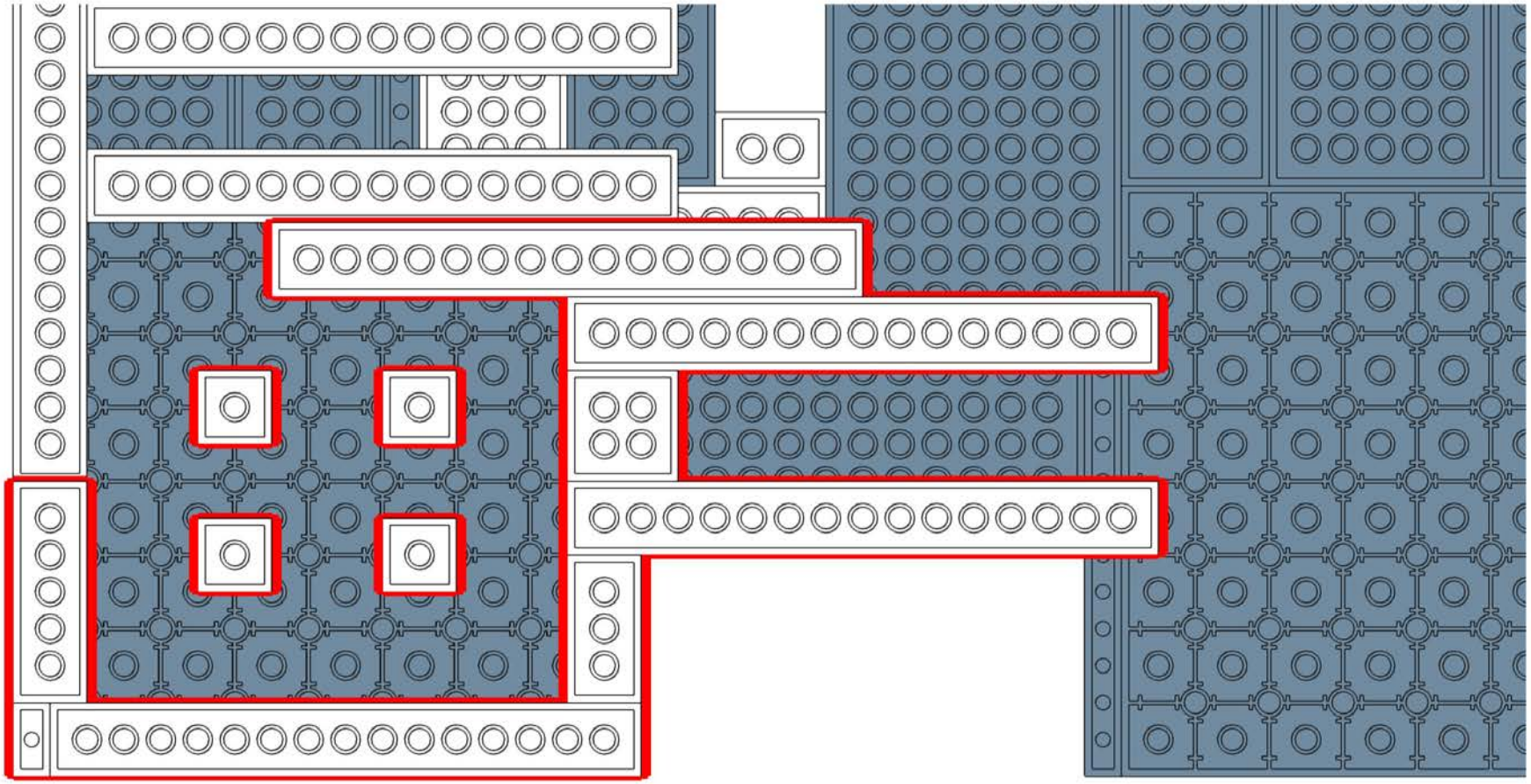

494

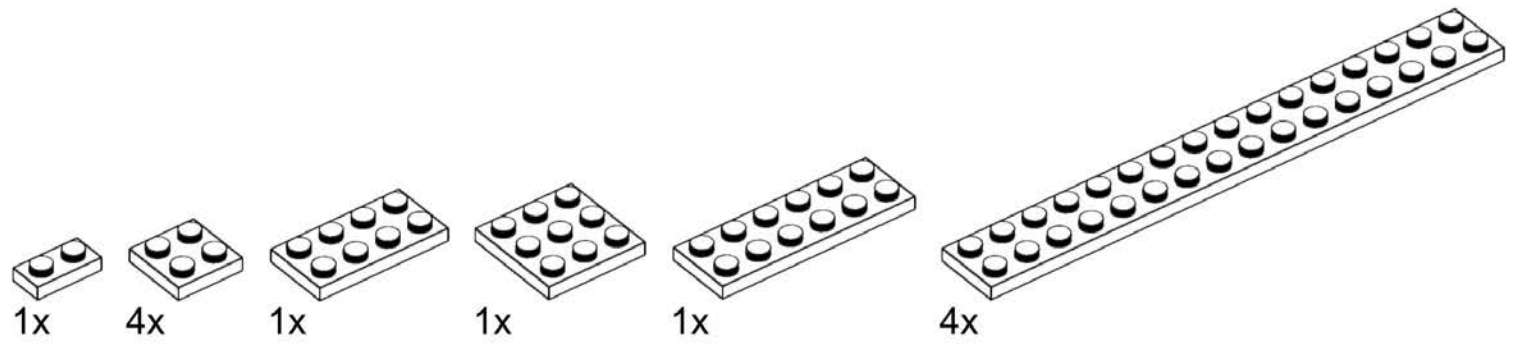

# 495

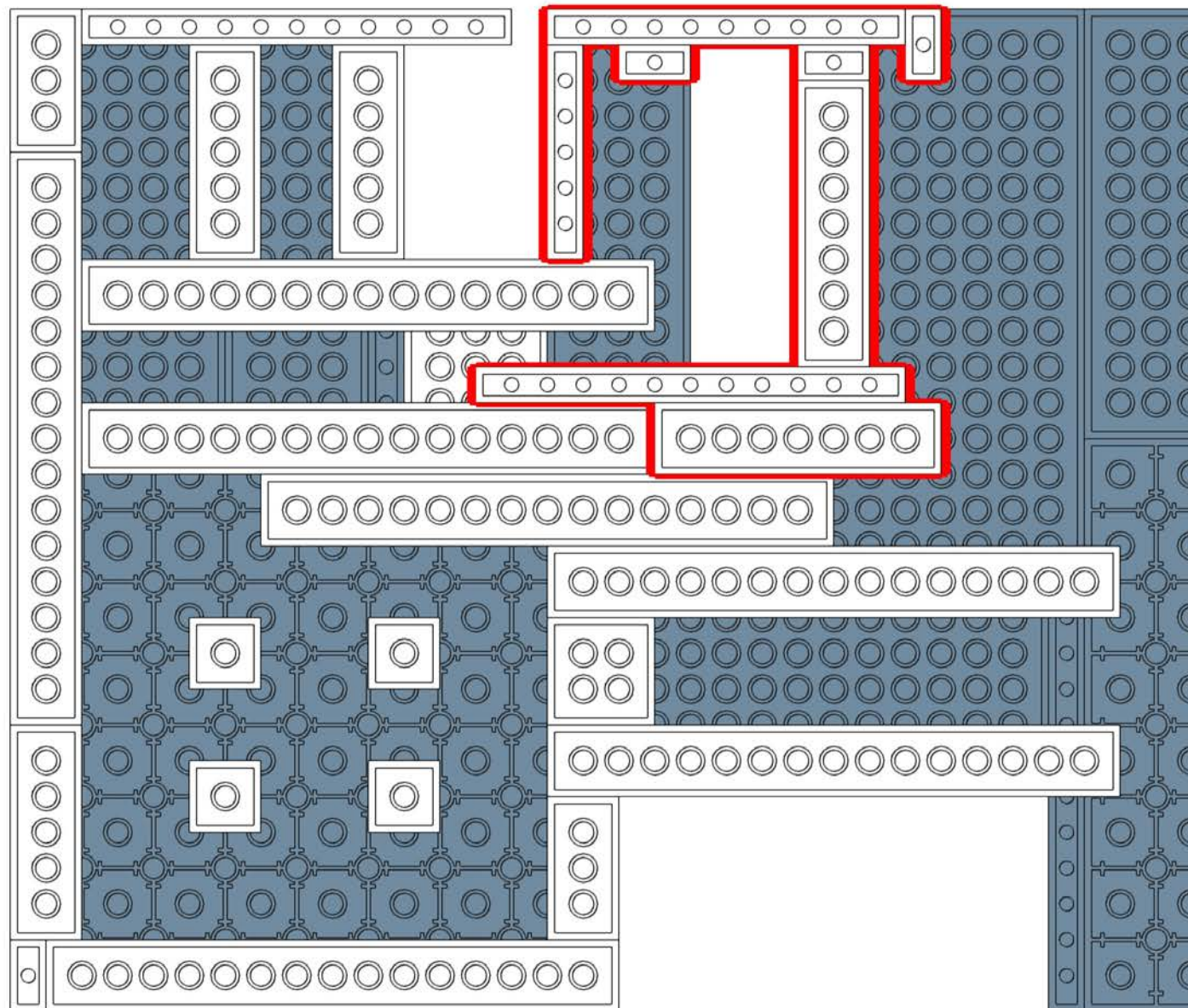
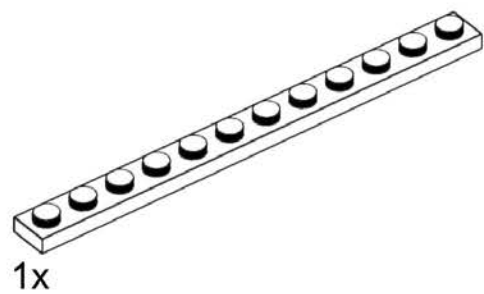
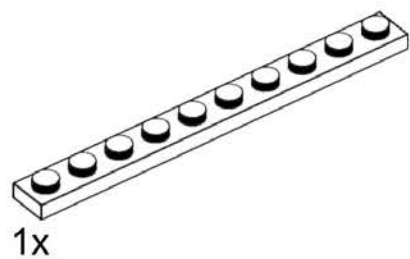
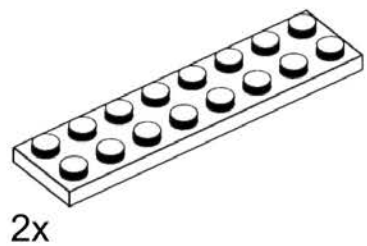
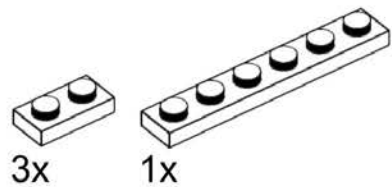

# 496

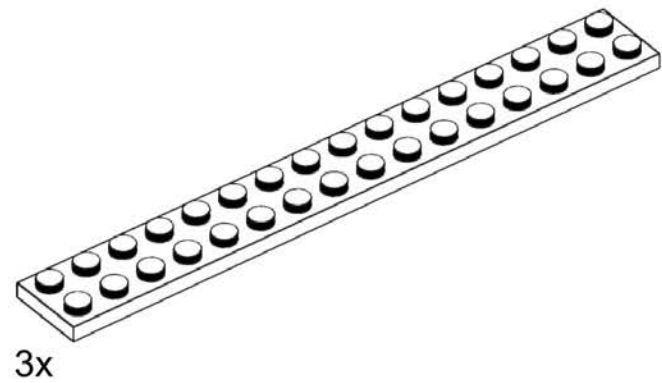
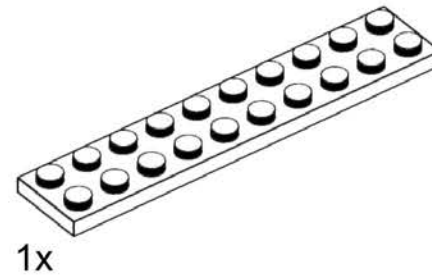
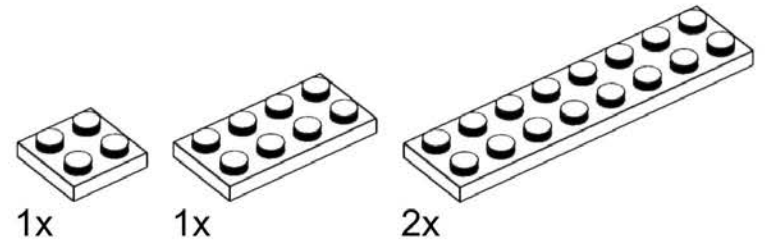
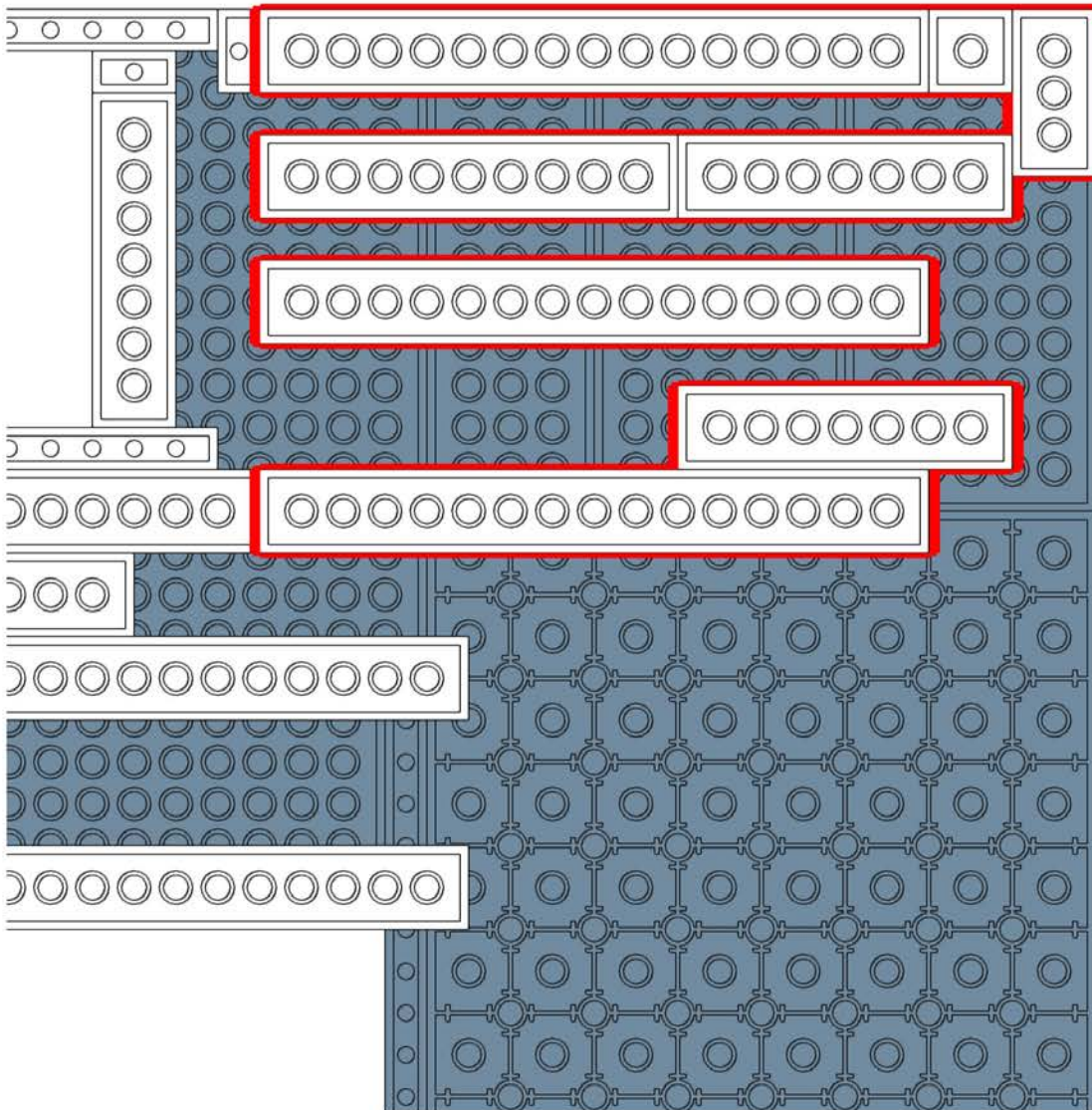

# 497

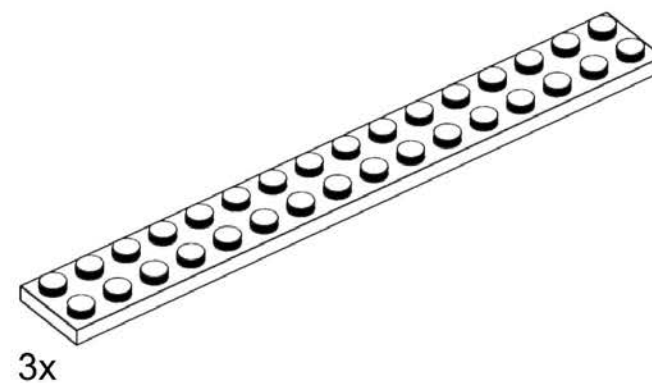
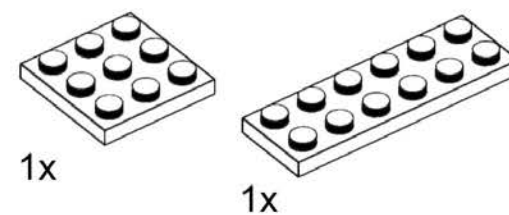
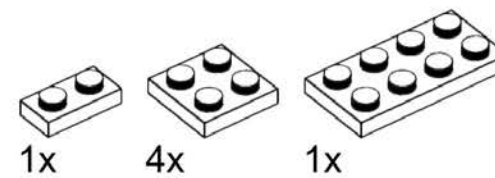
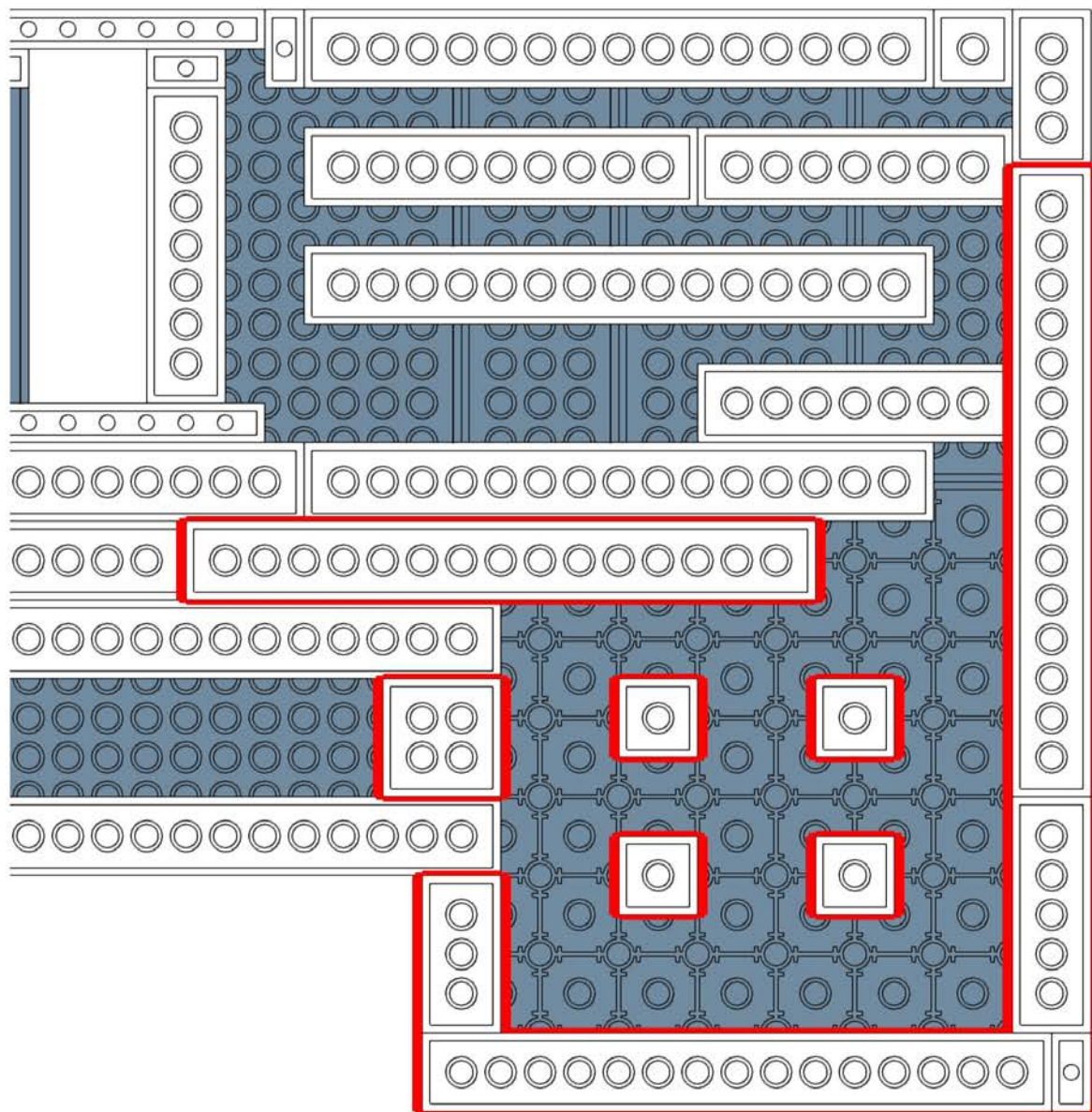

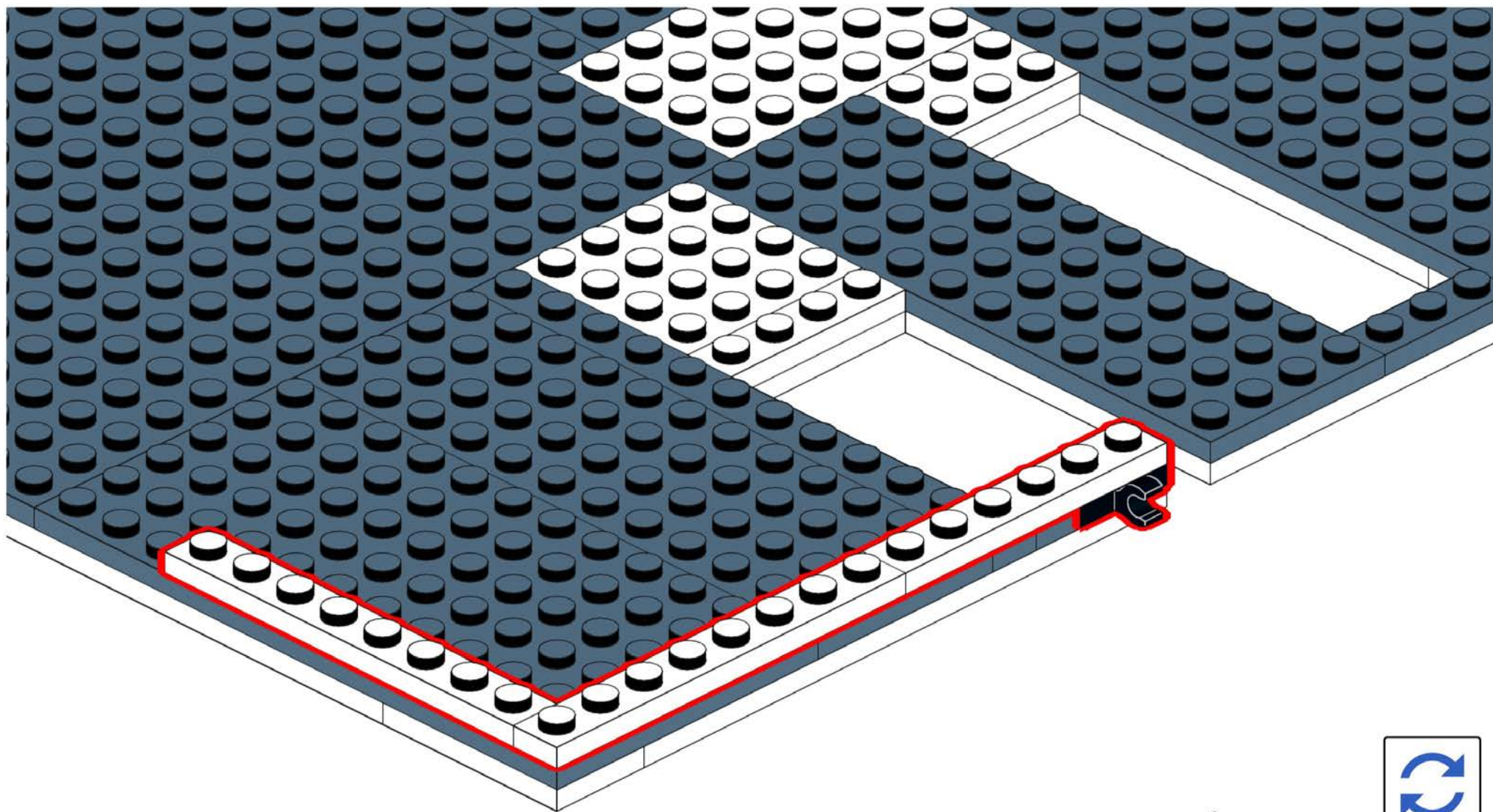

1x

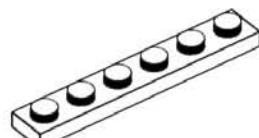

1x

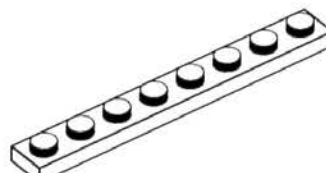

2x



# 498



# 499

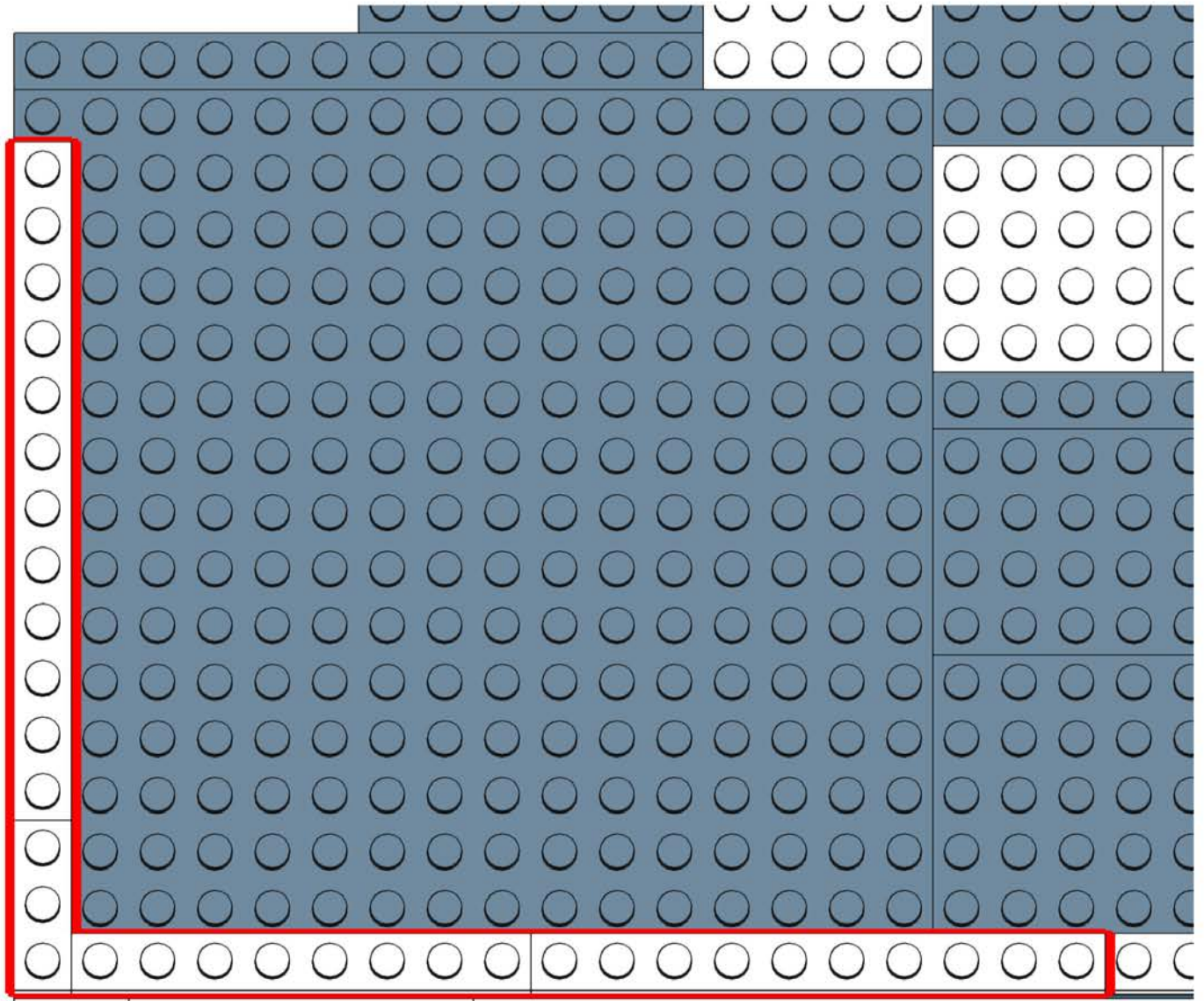
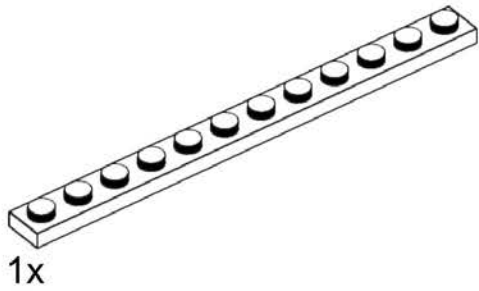
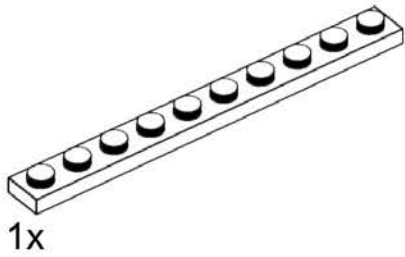
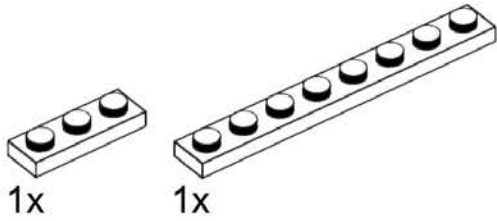

# 500

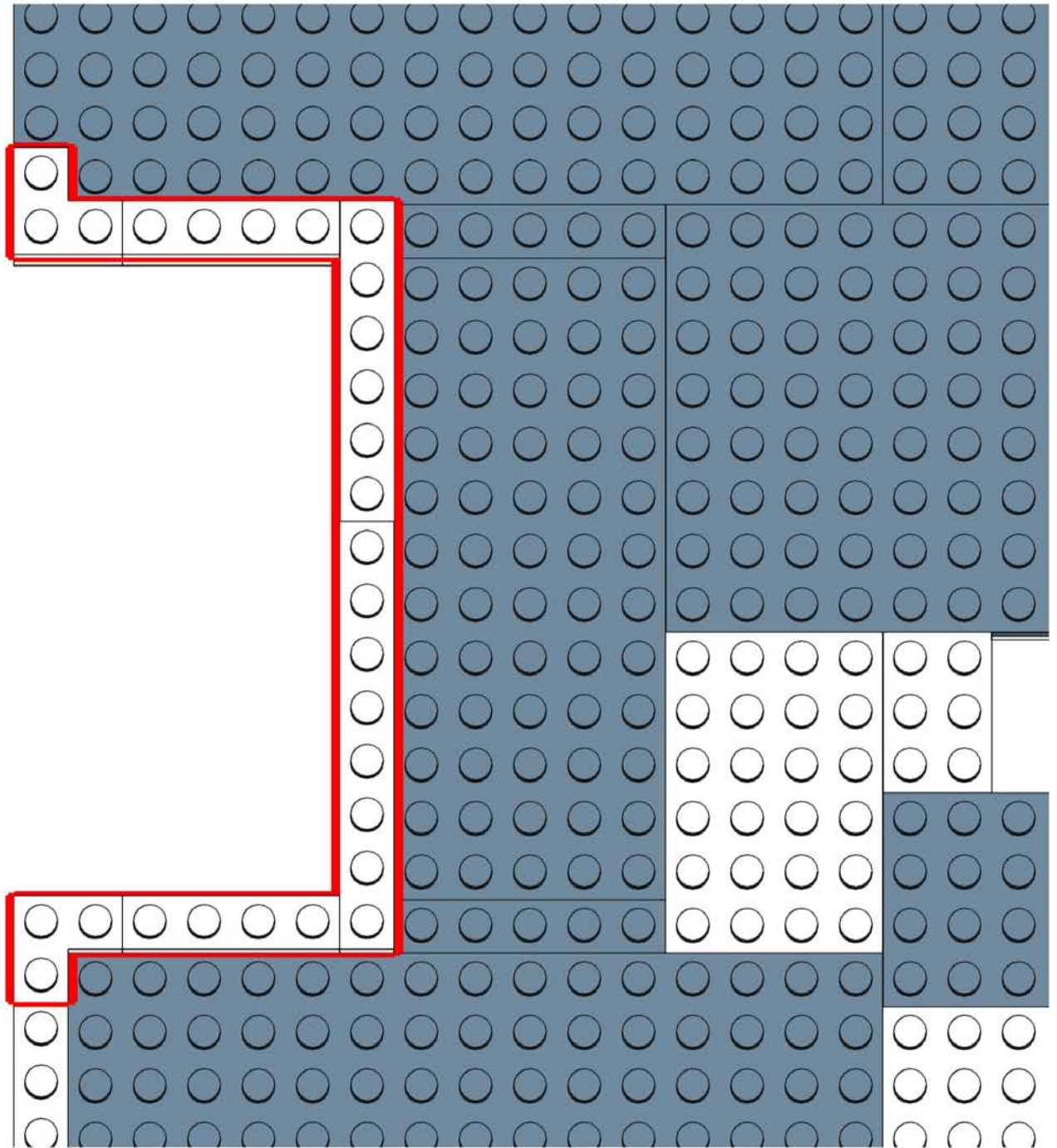
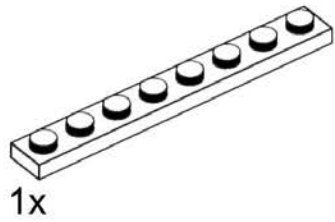
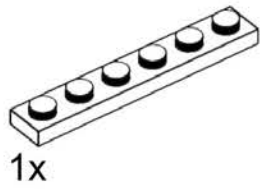
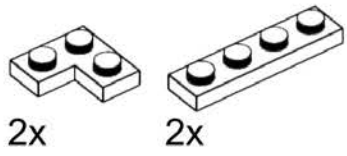

# 501

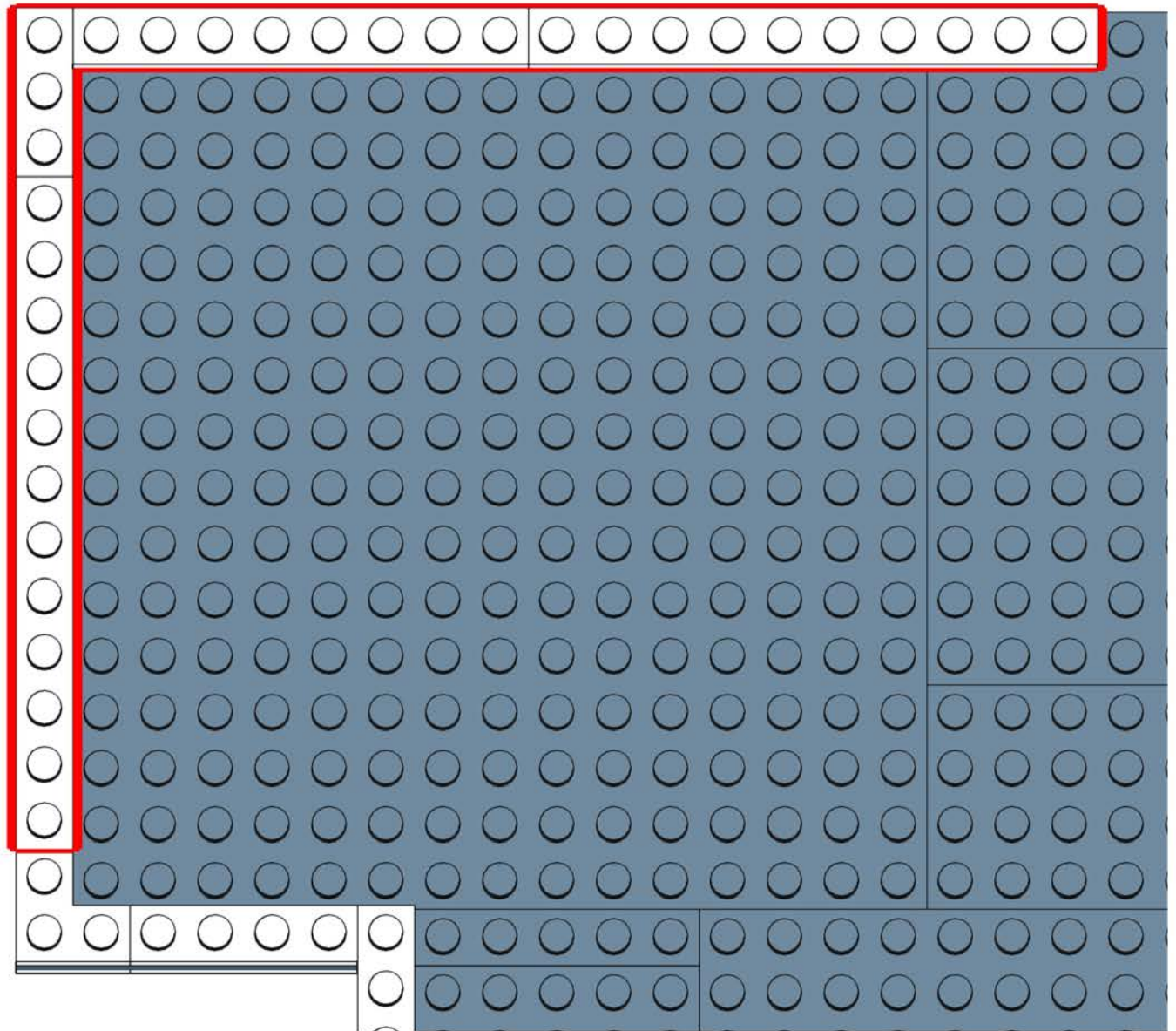
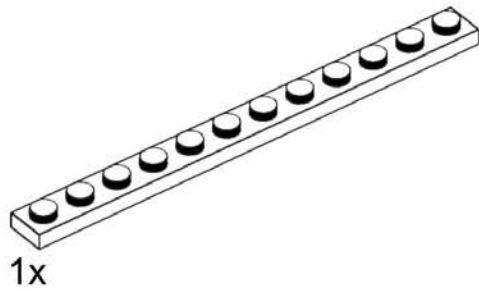
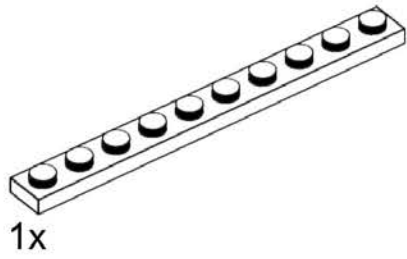
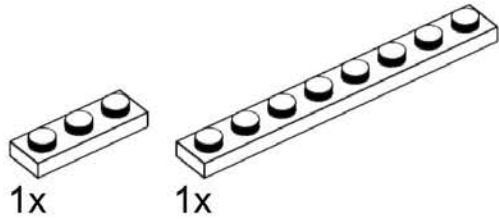

# 502

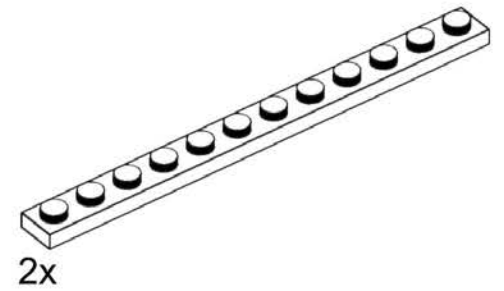
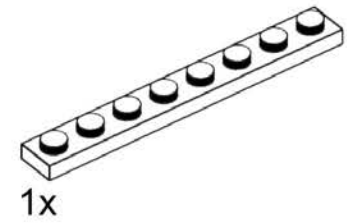
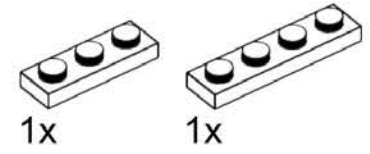
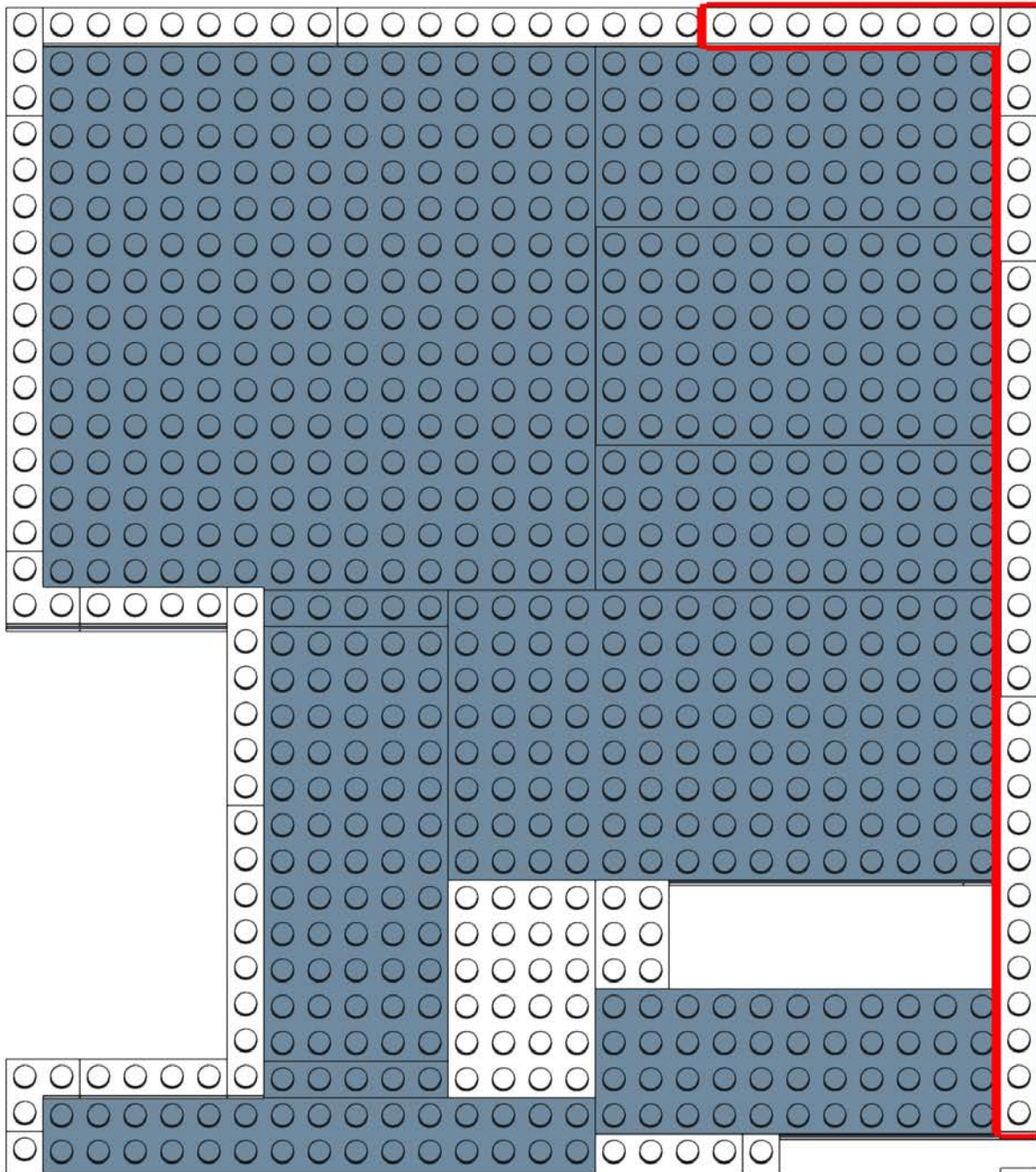

# 503

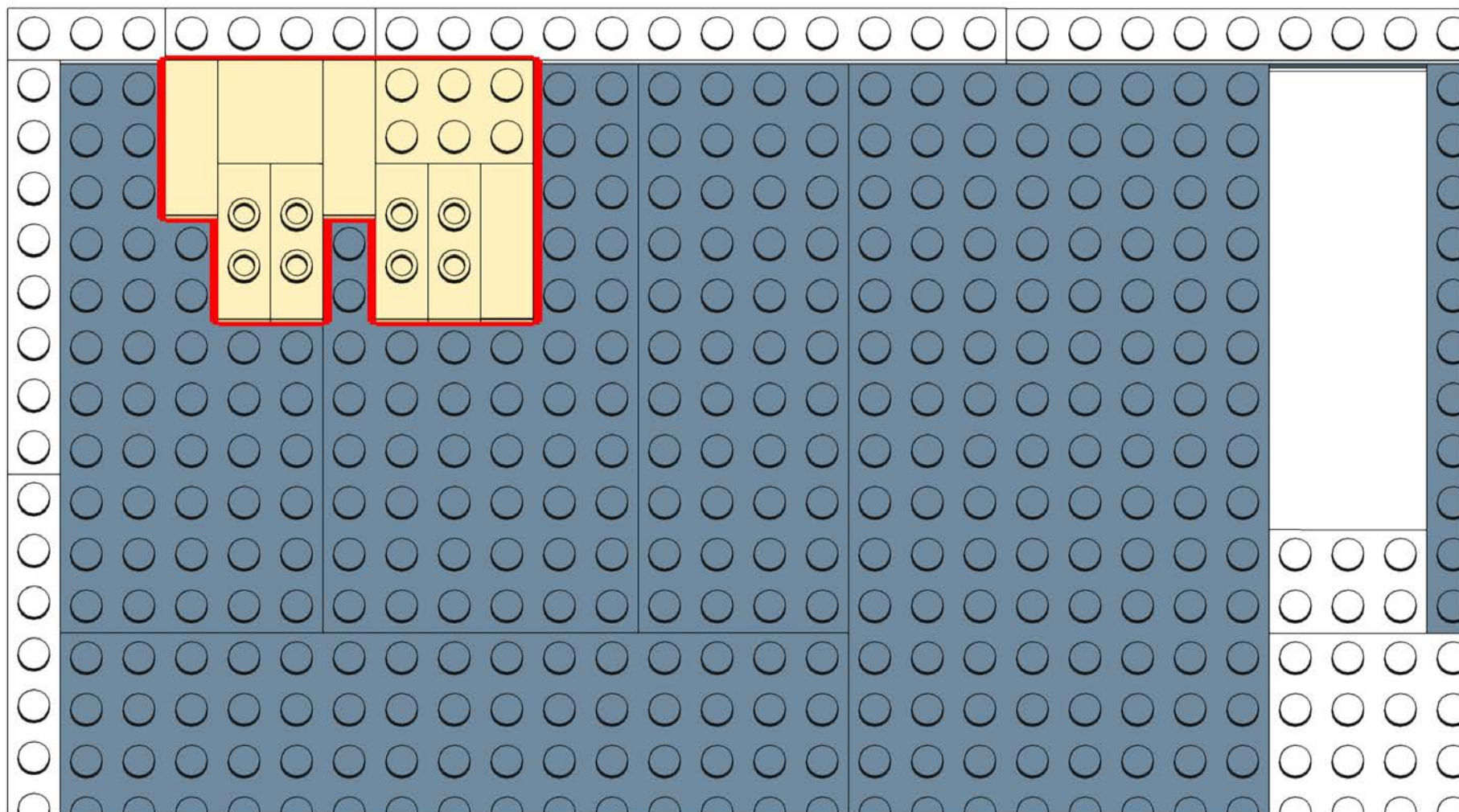
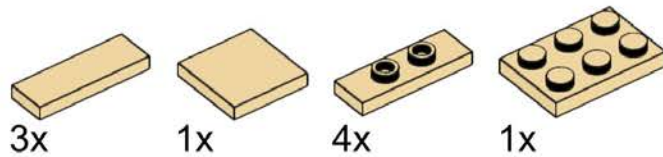

# 504

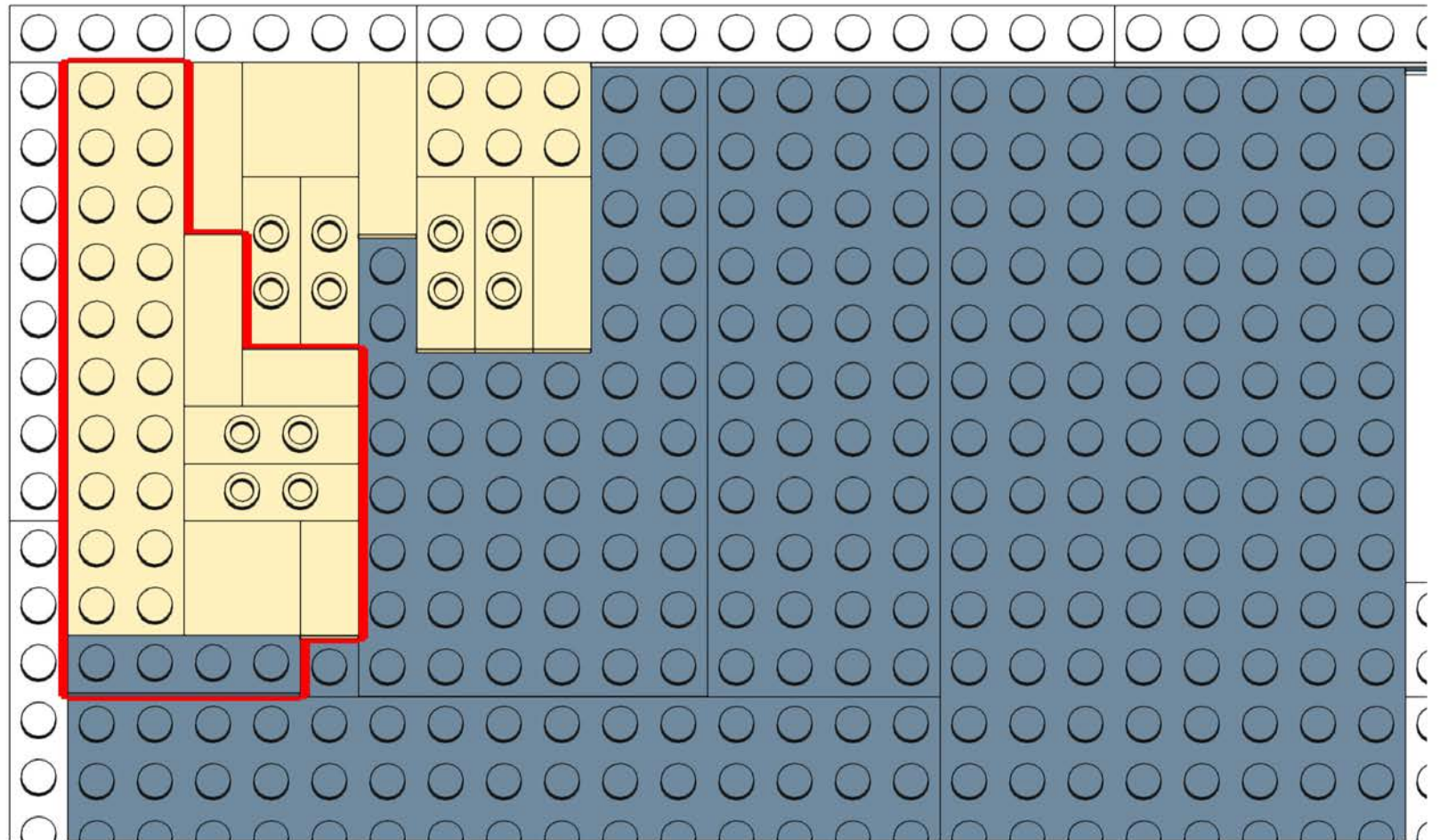
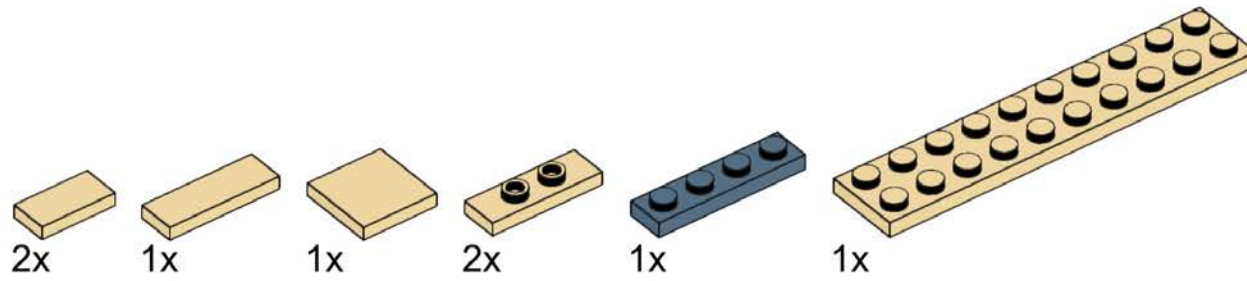

# 505

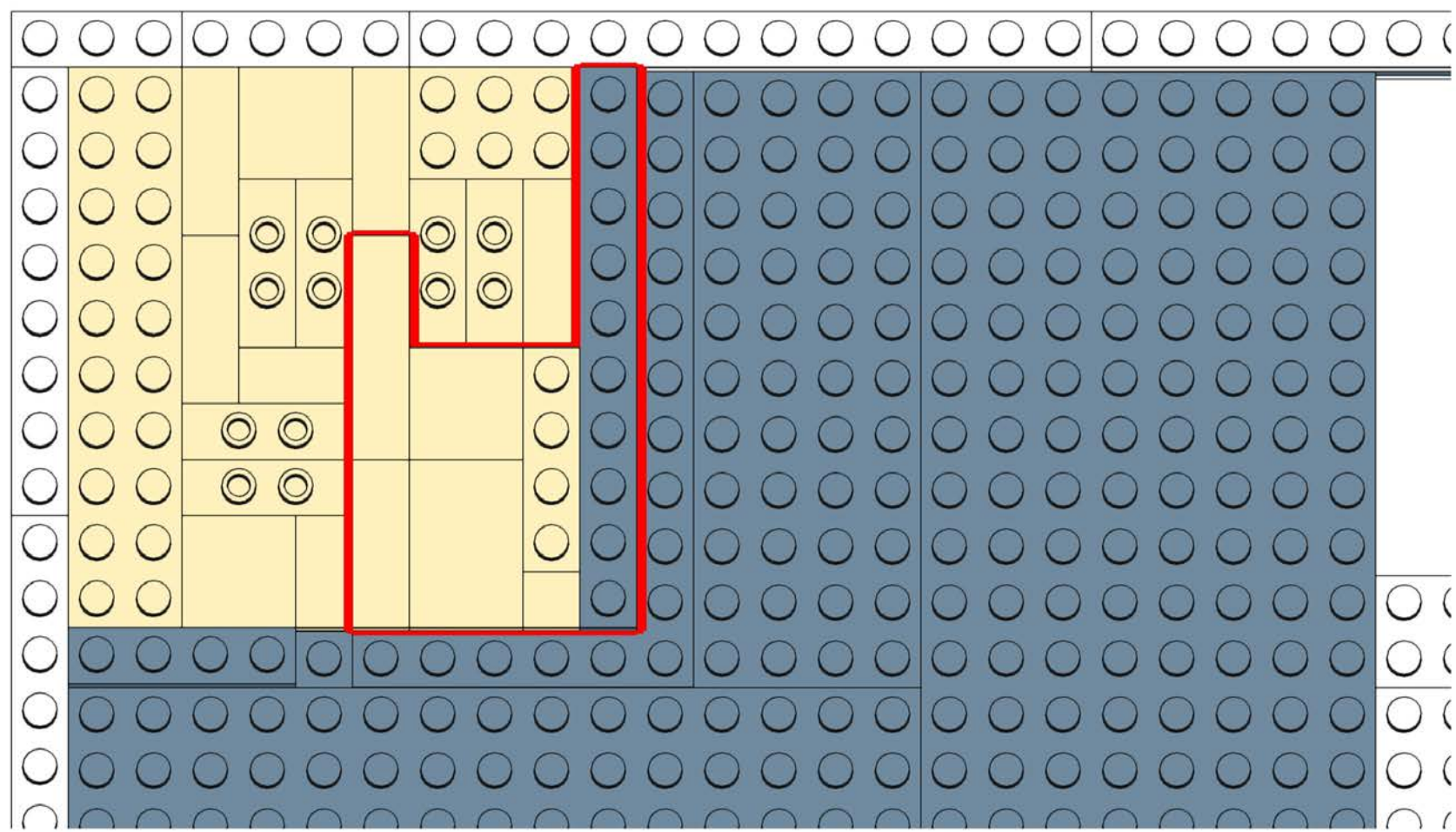
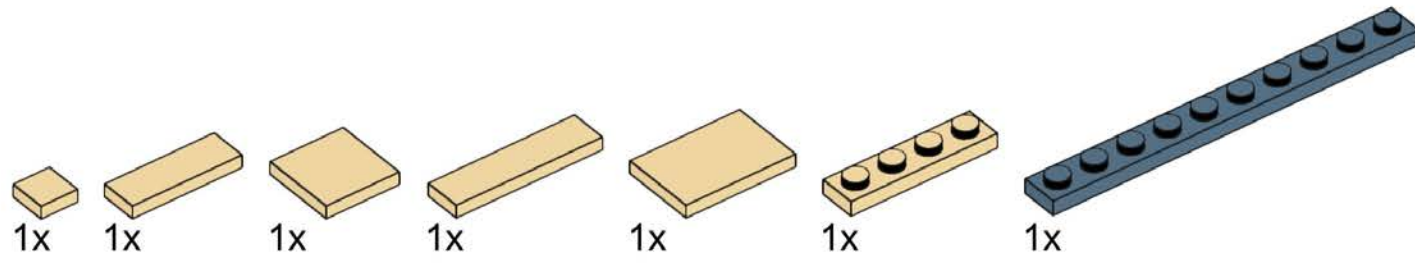

# 506

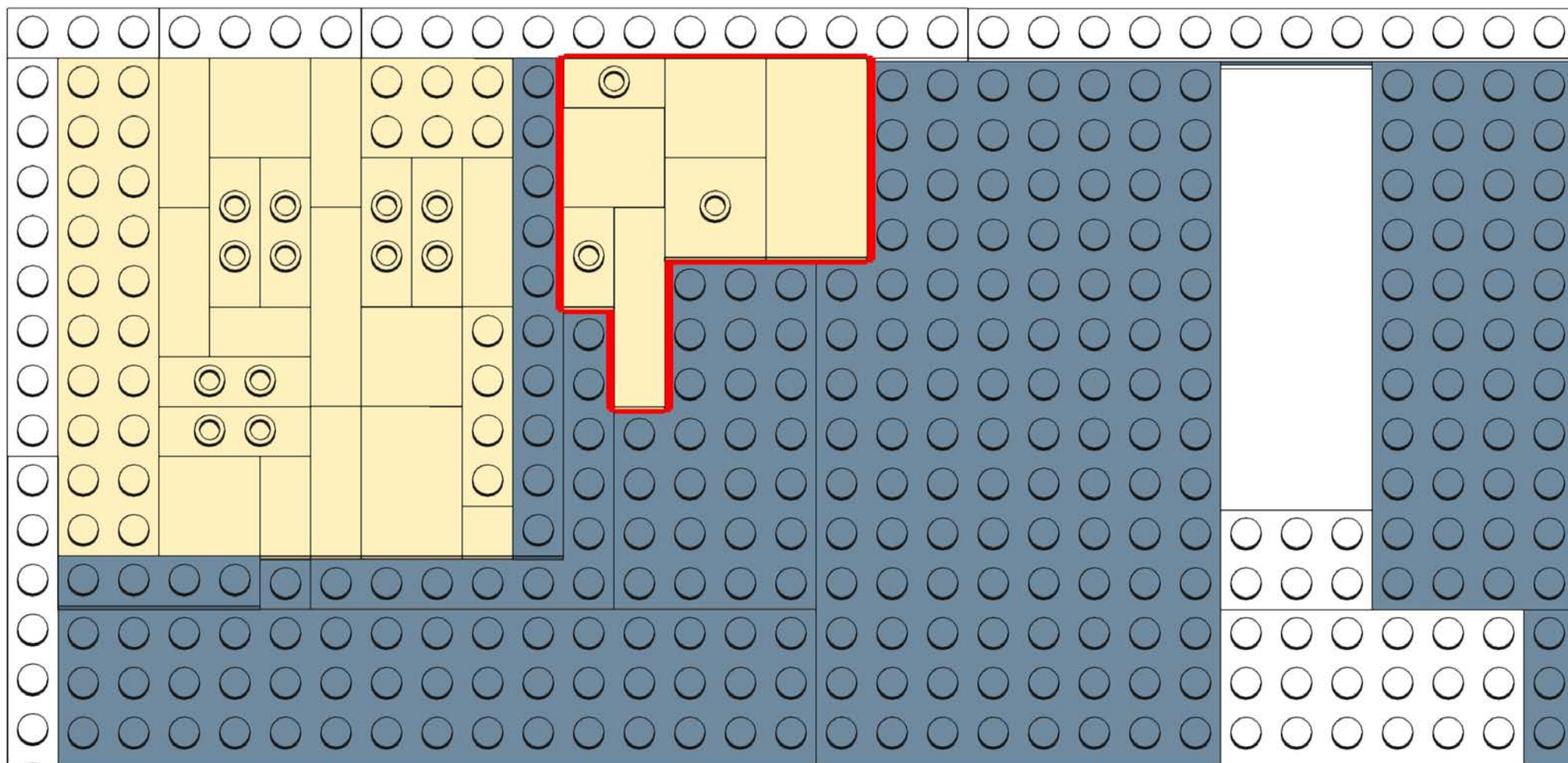
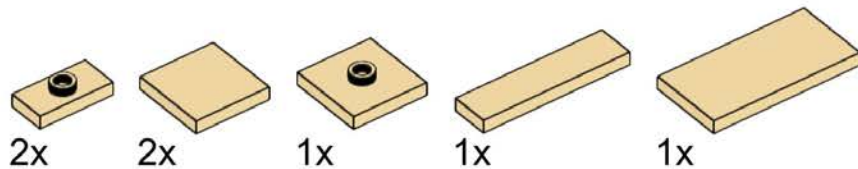



# 507

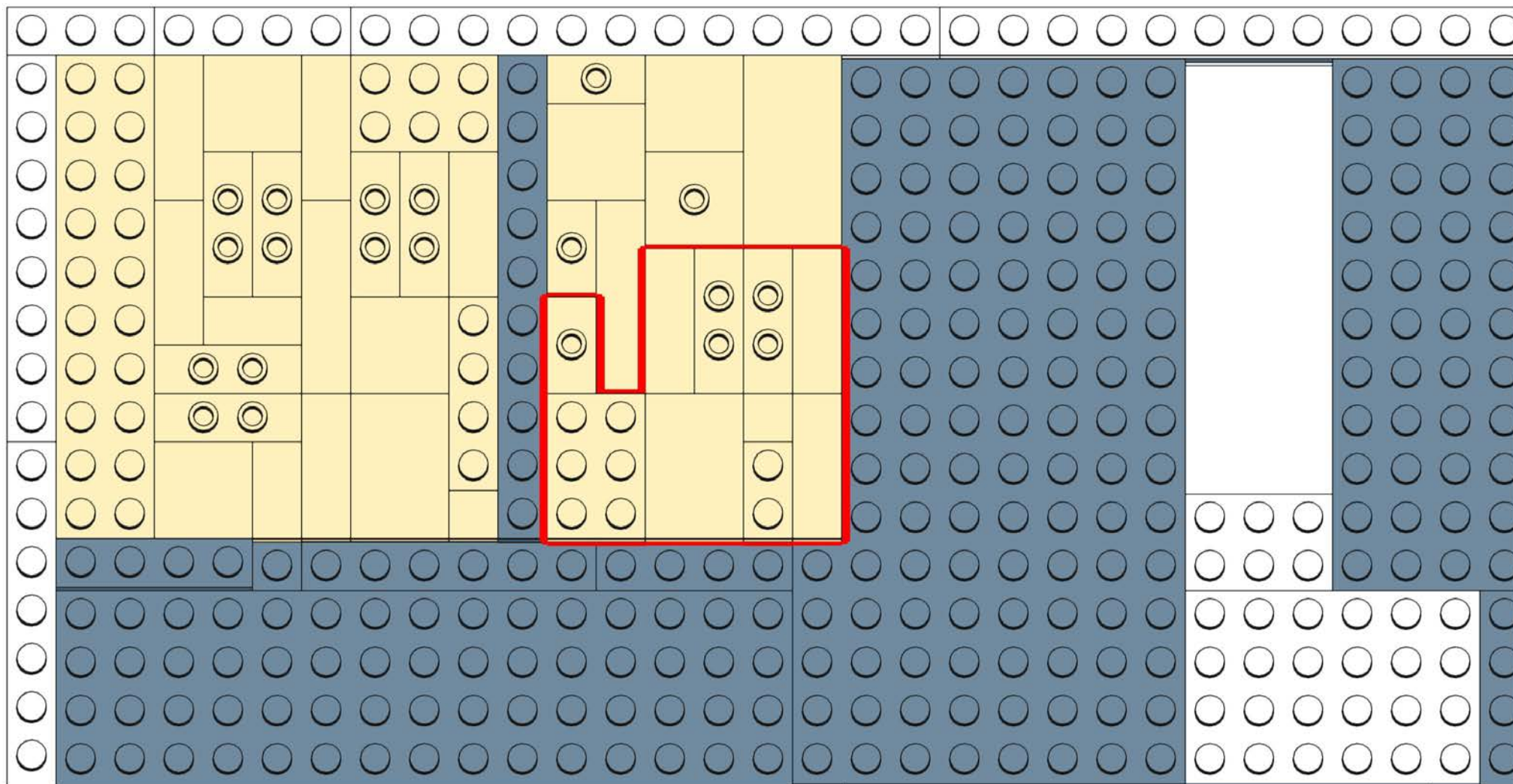
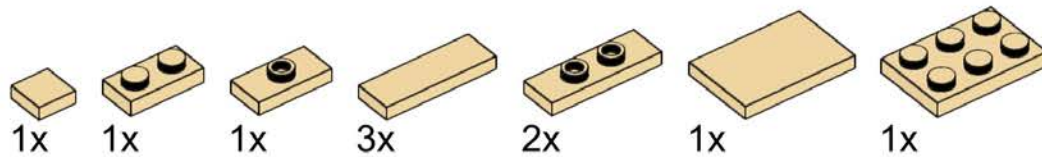

# 508

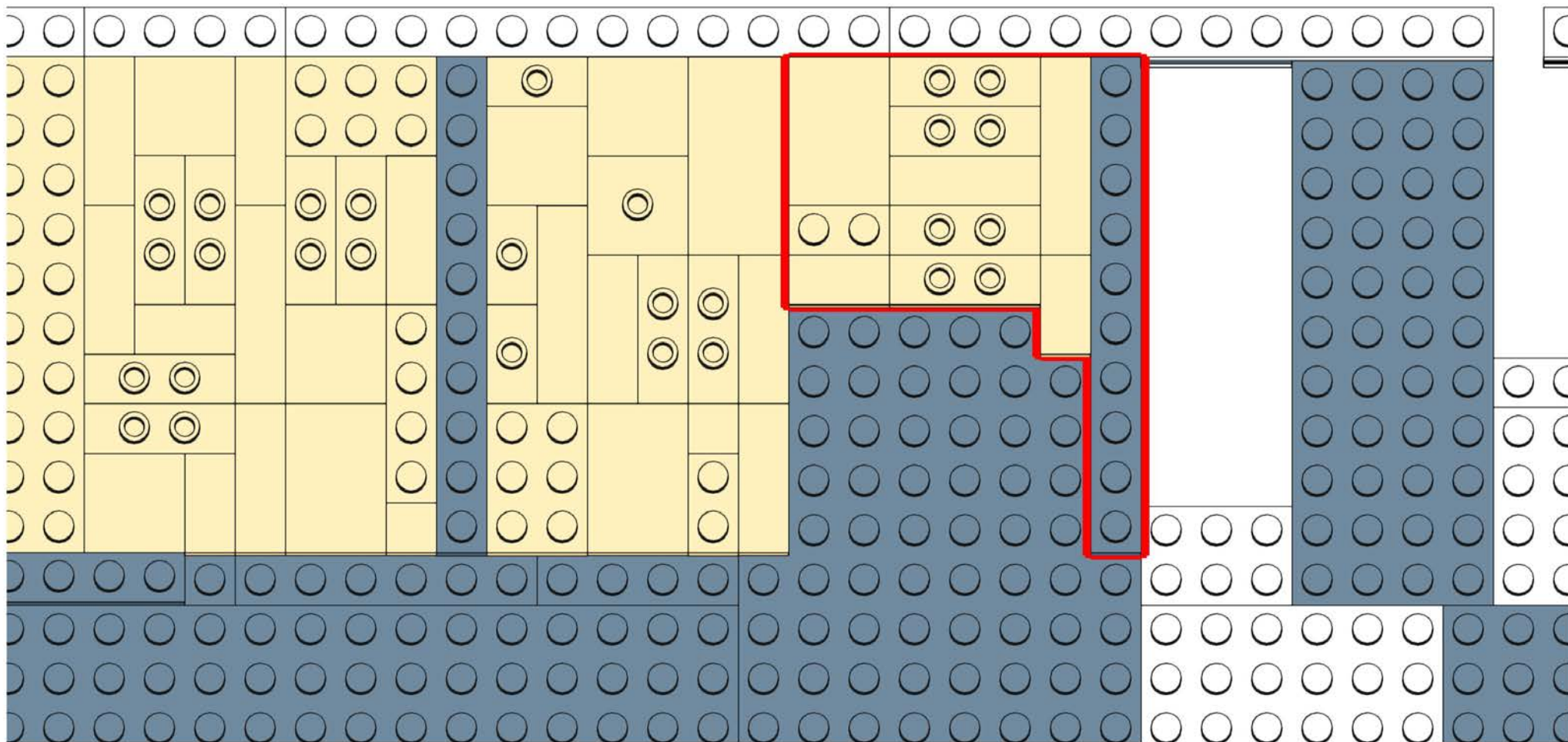
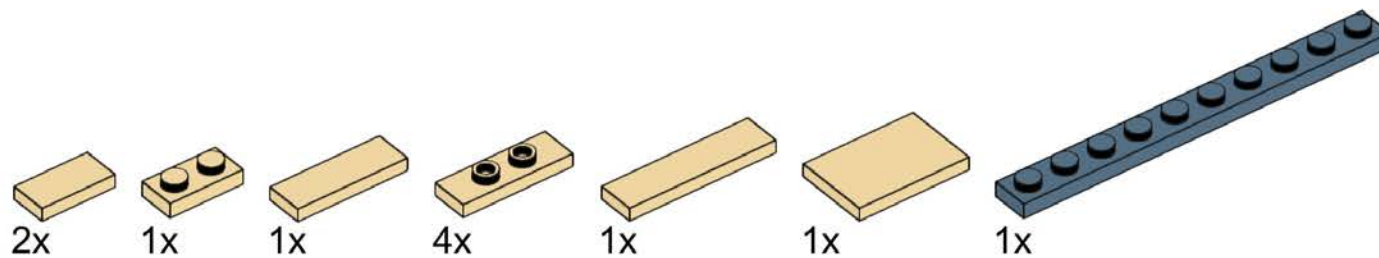



# 510



1x

2x



8x

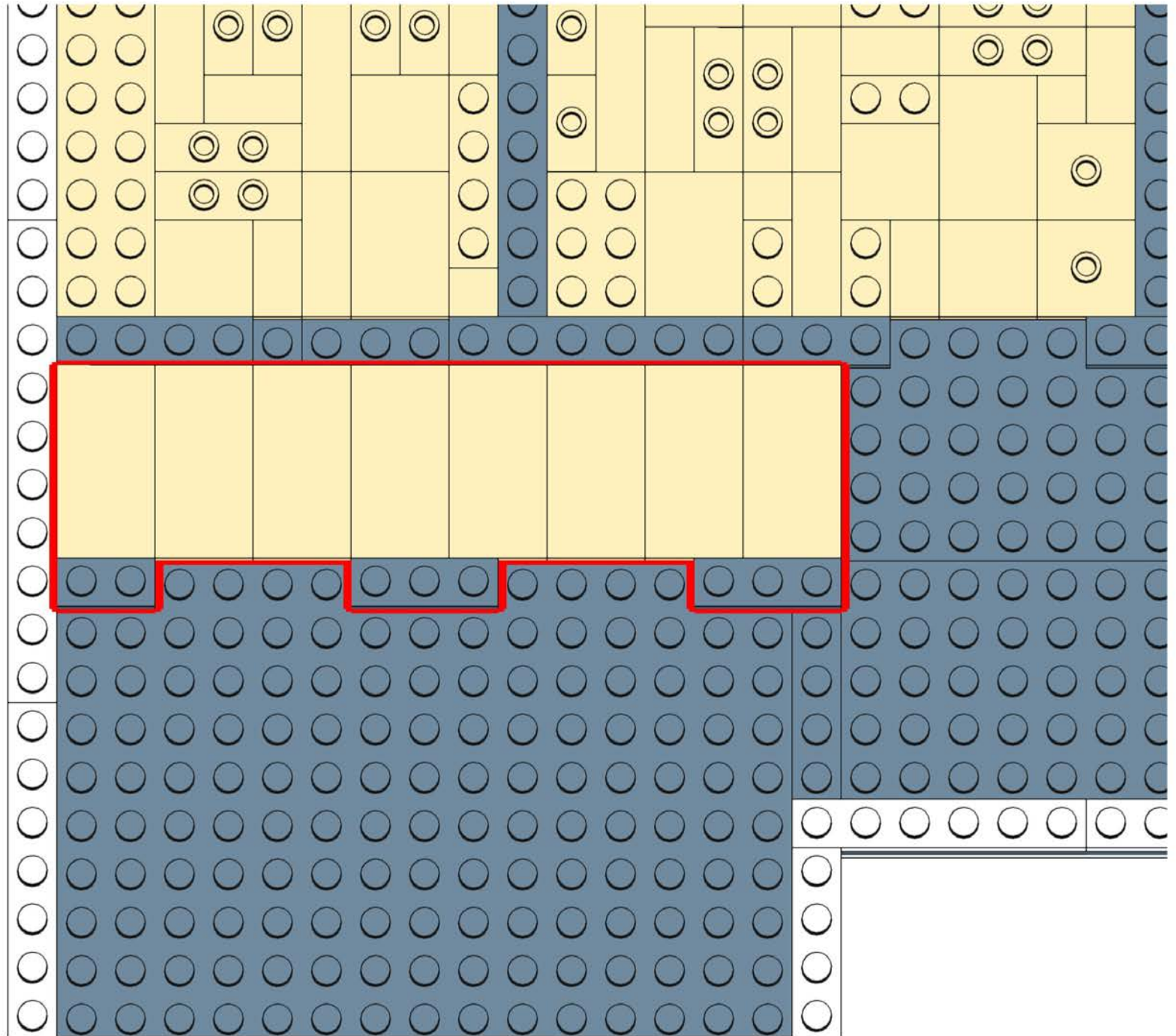

# 511

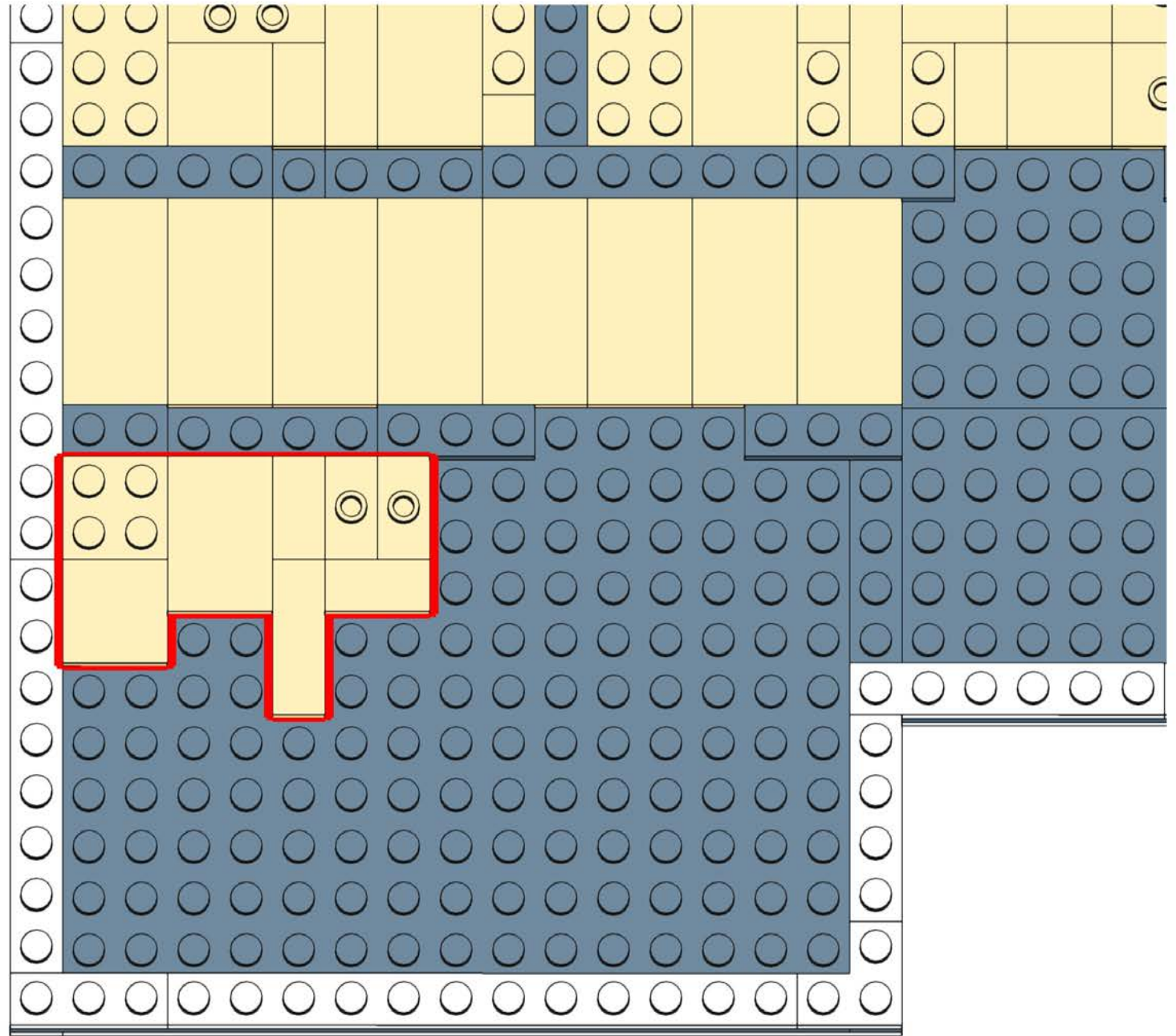
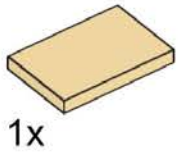
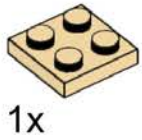
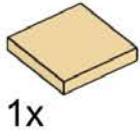
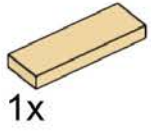
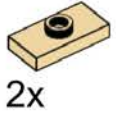
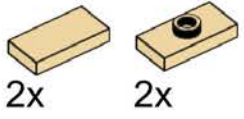

# 512

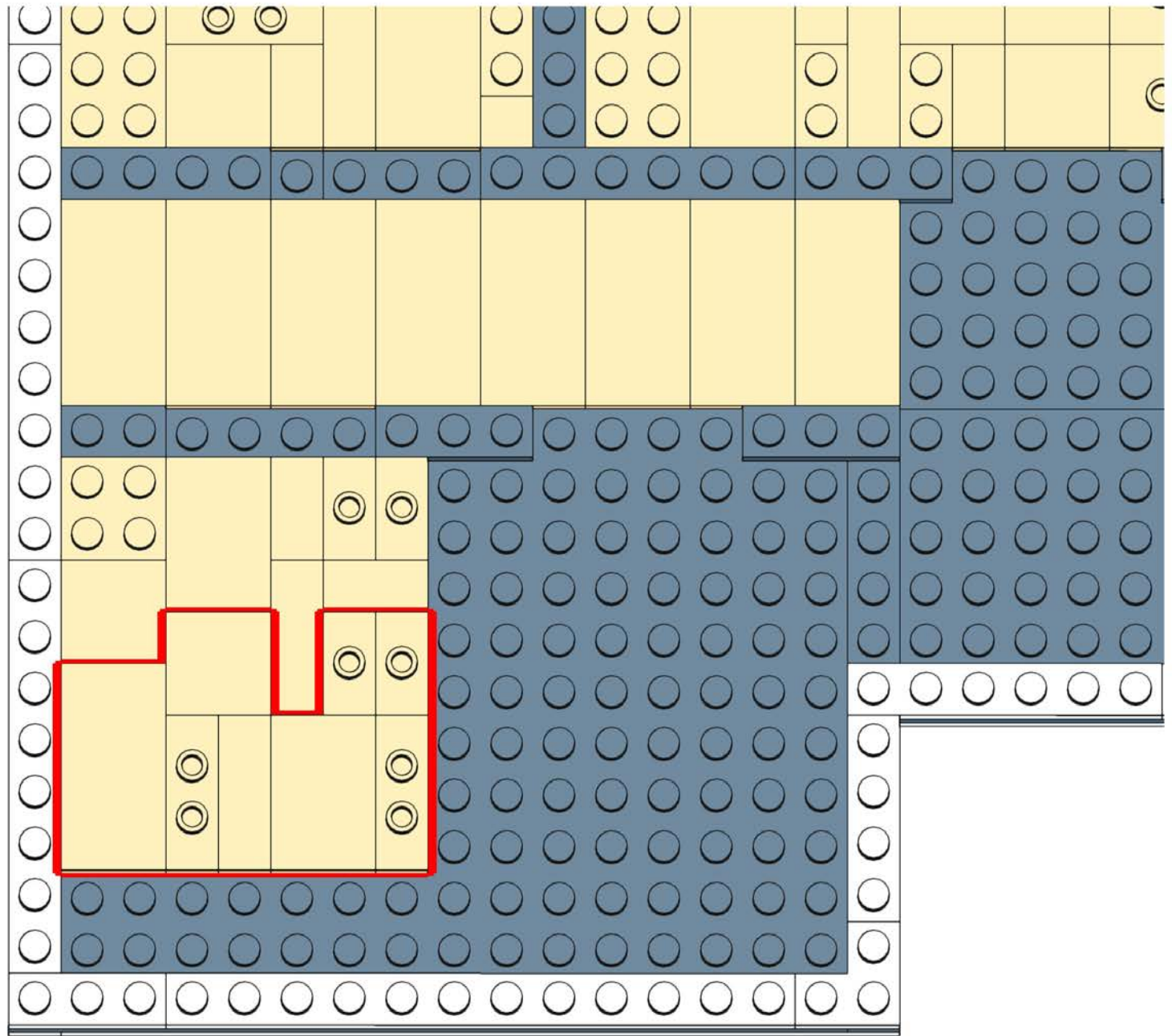
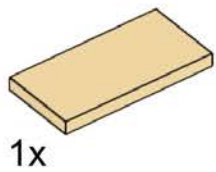
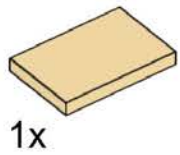
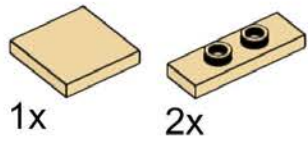
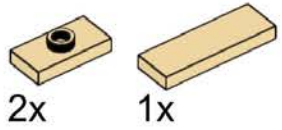

# 513

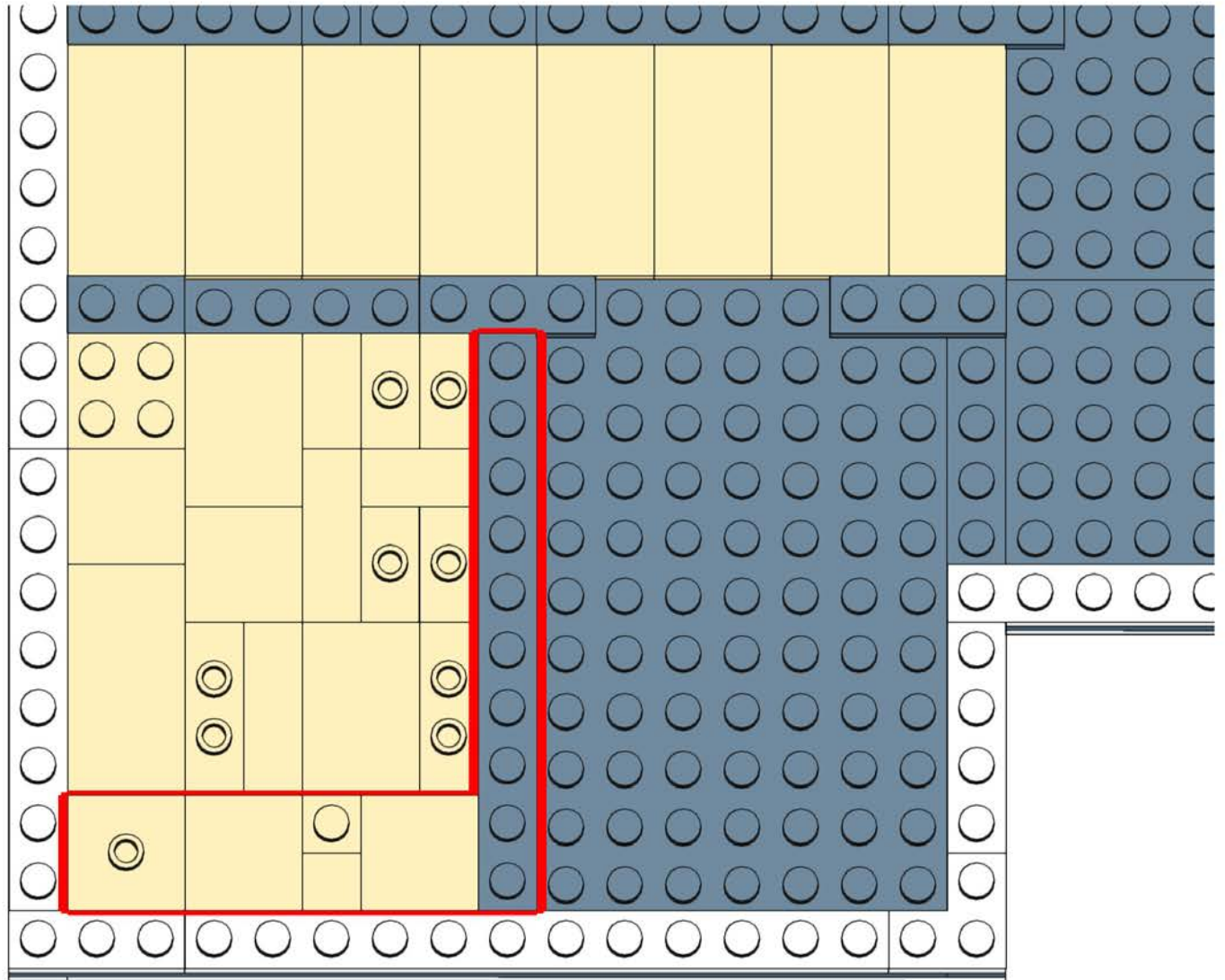
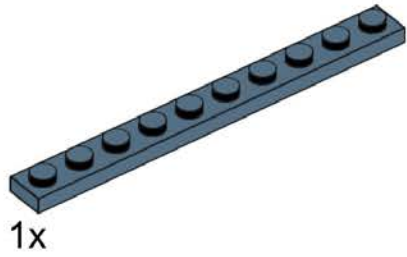
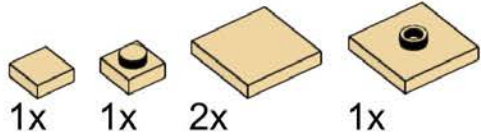

# 514

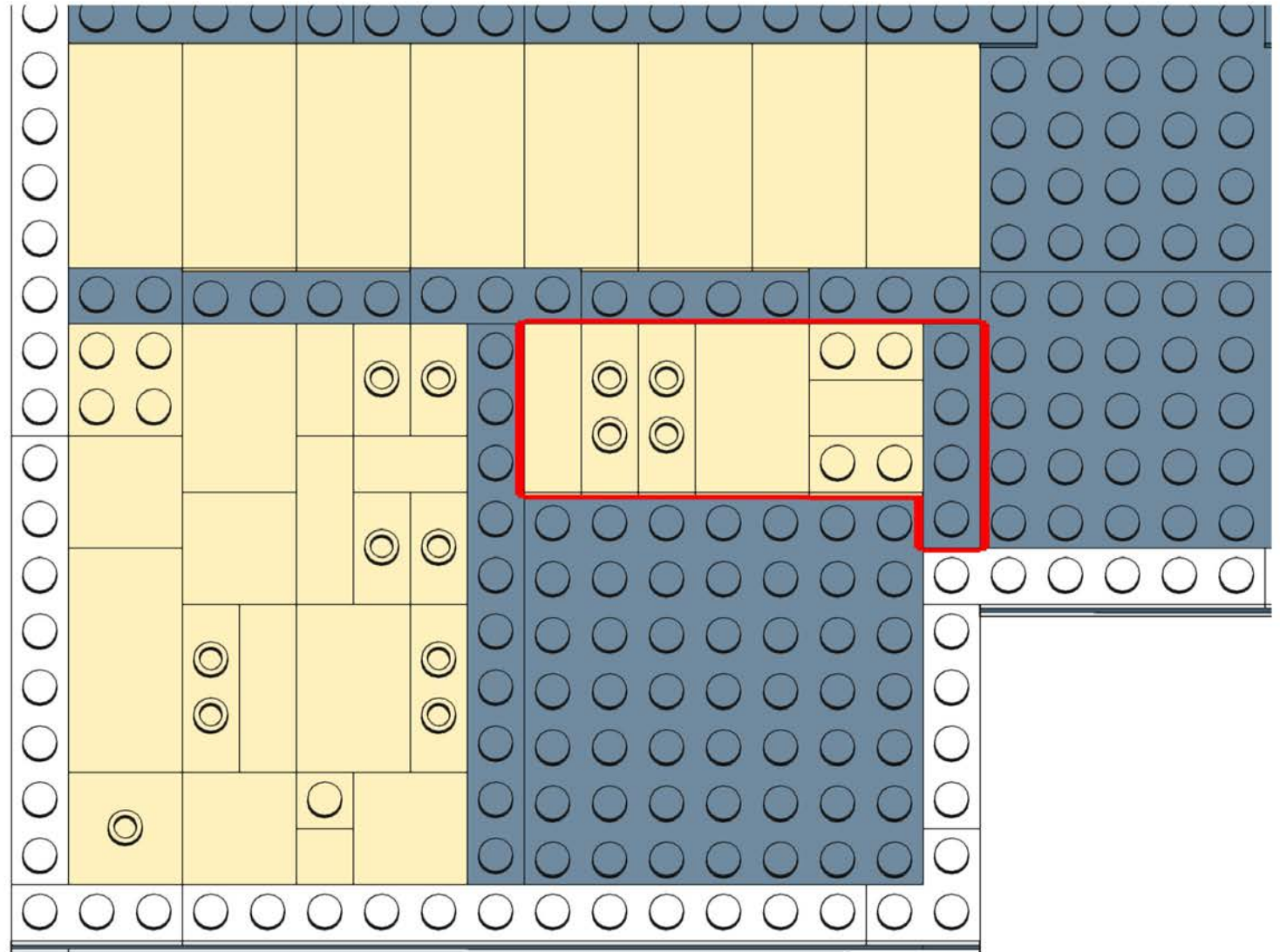
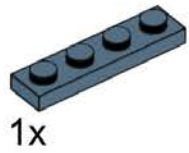
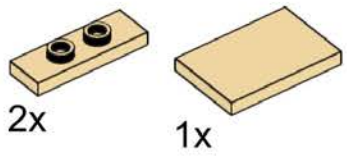
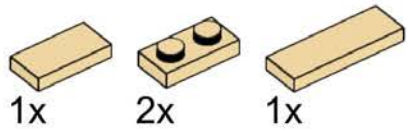



# 515

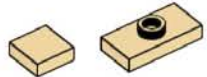

1x 1x



3x

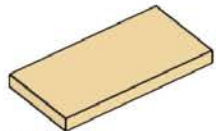

2x

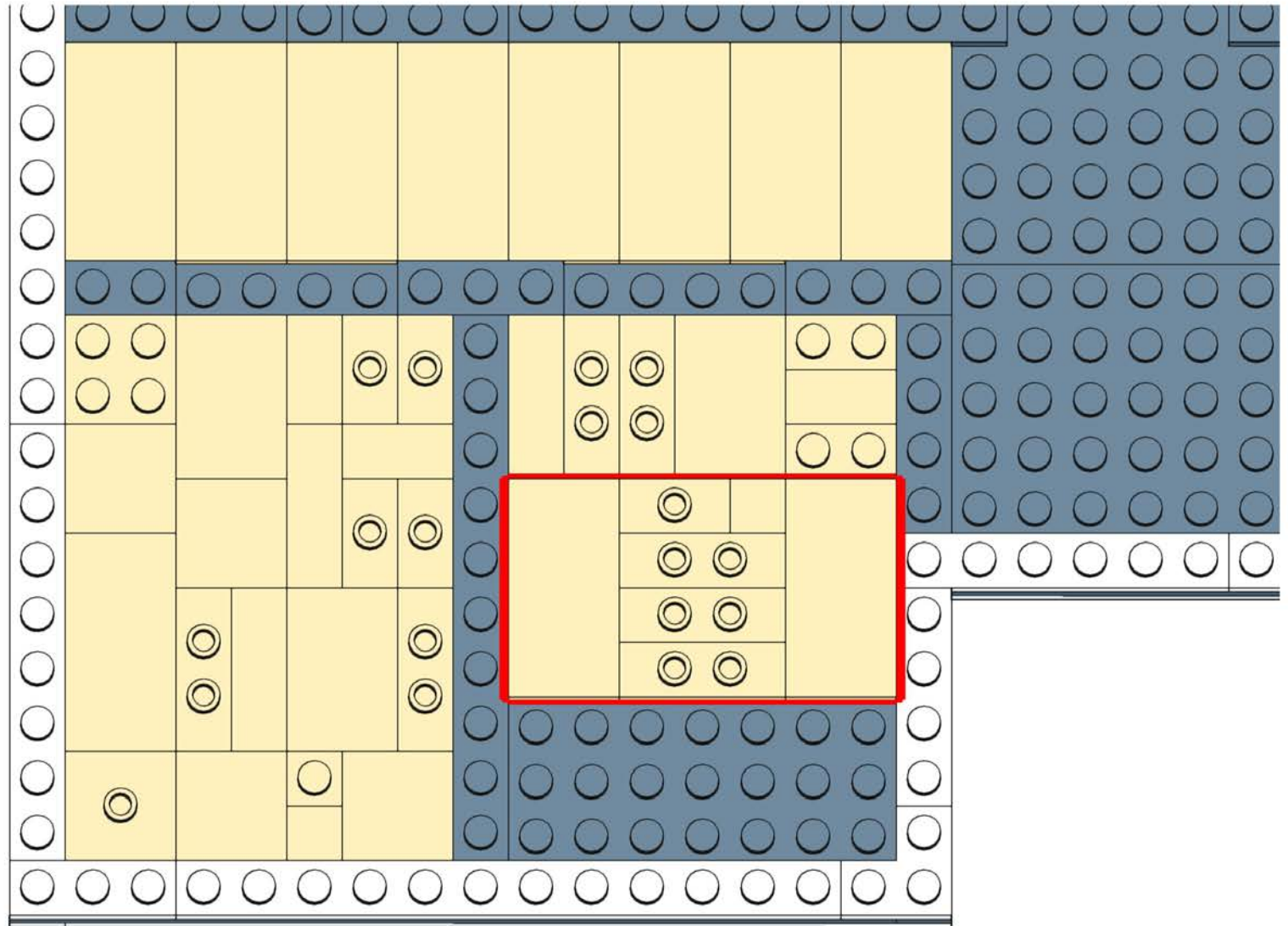

# 516

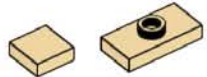

1x 1x

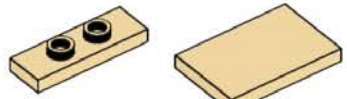

2x 2x

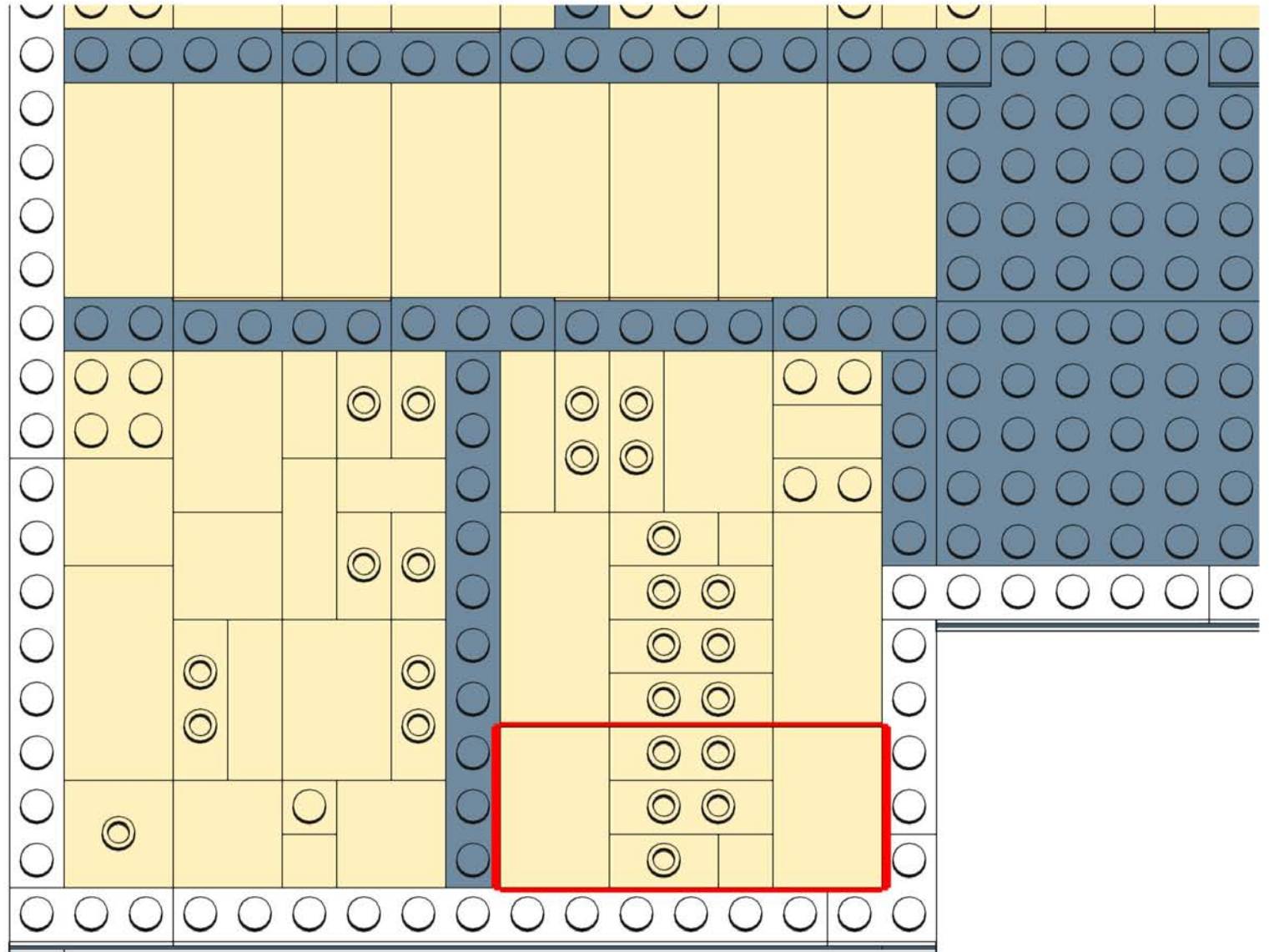

# 517

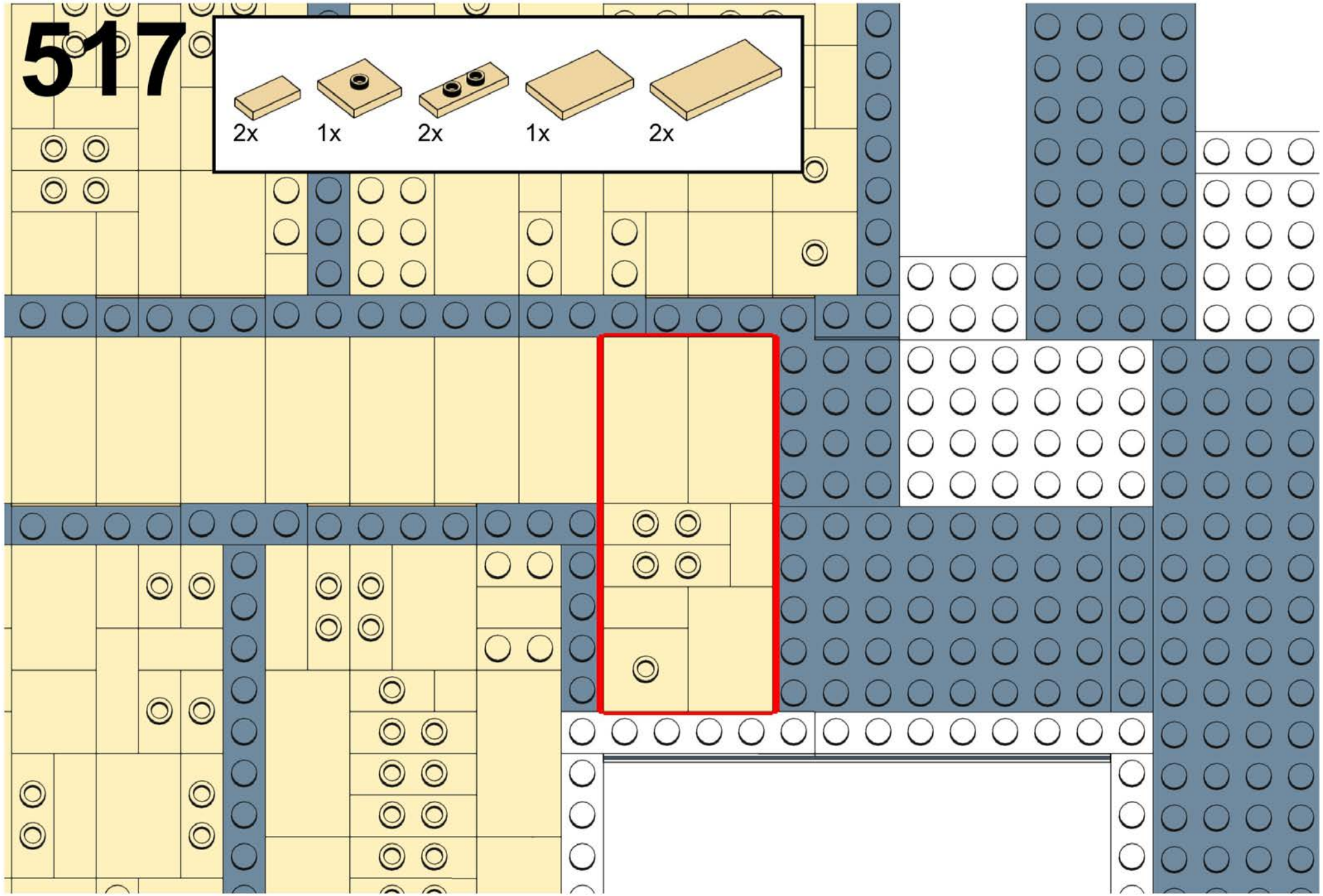
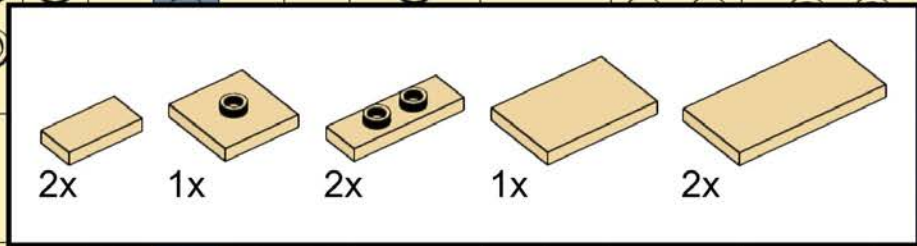

# 518

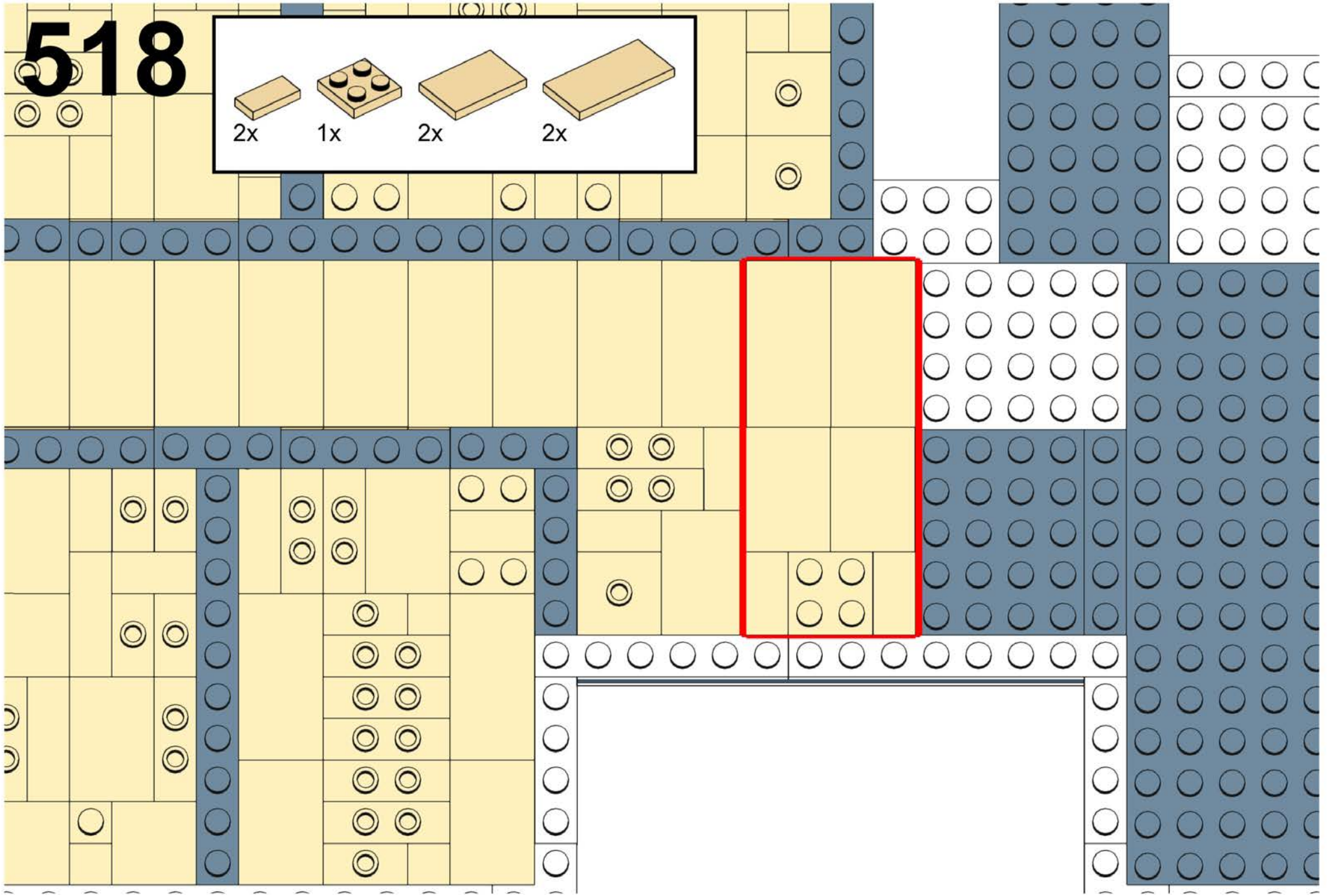
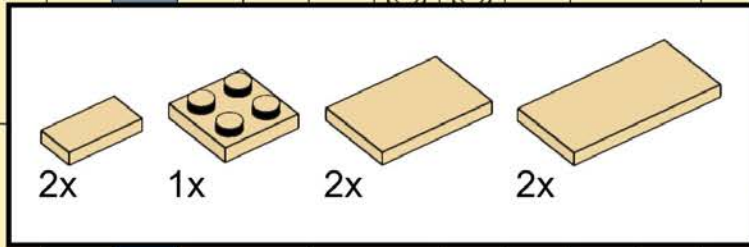

# 519

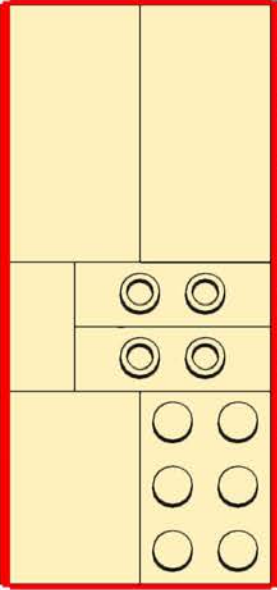
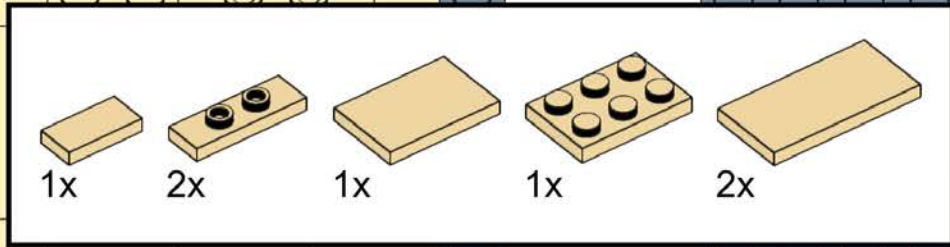

# 520

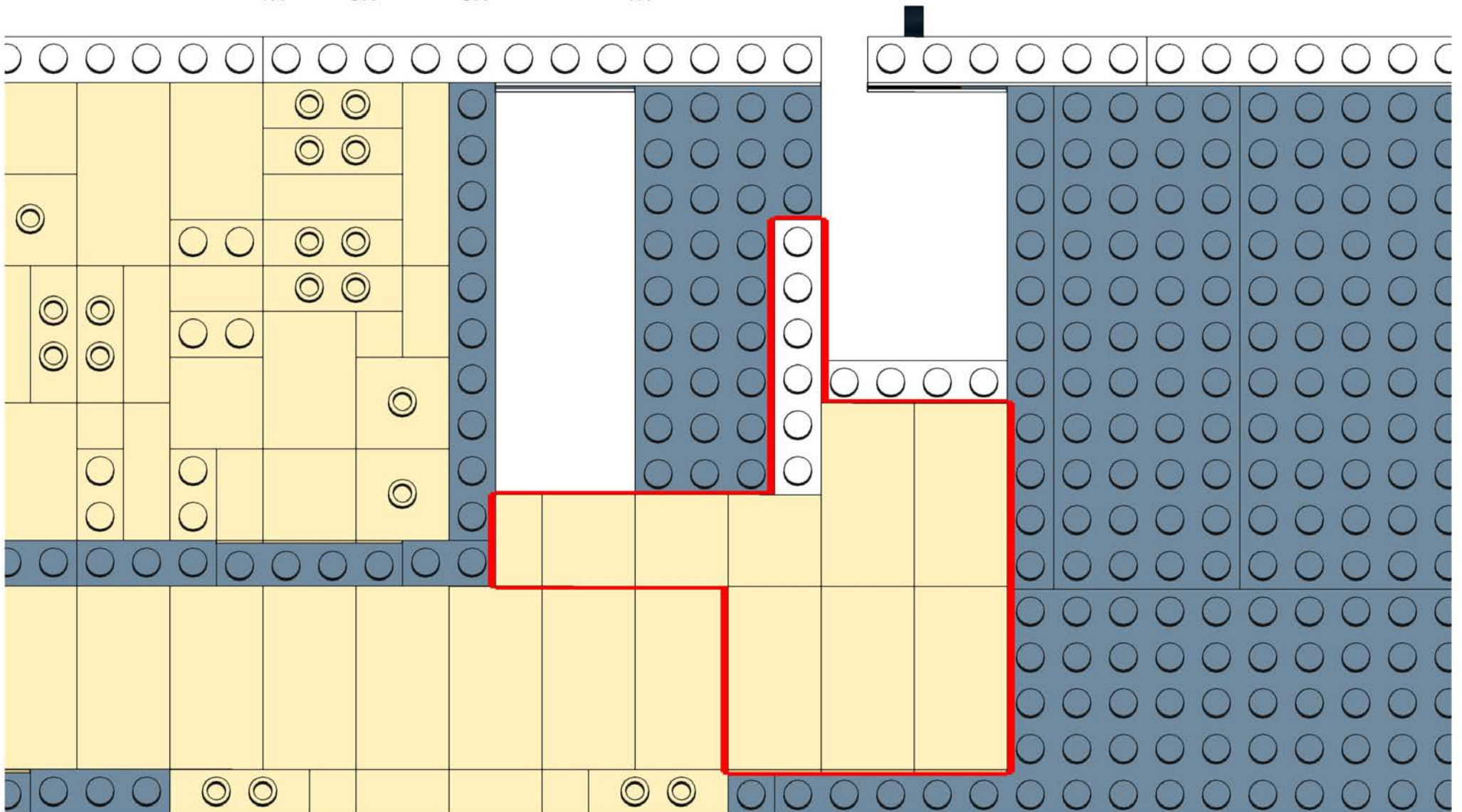
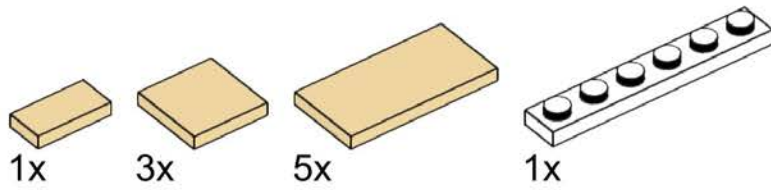

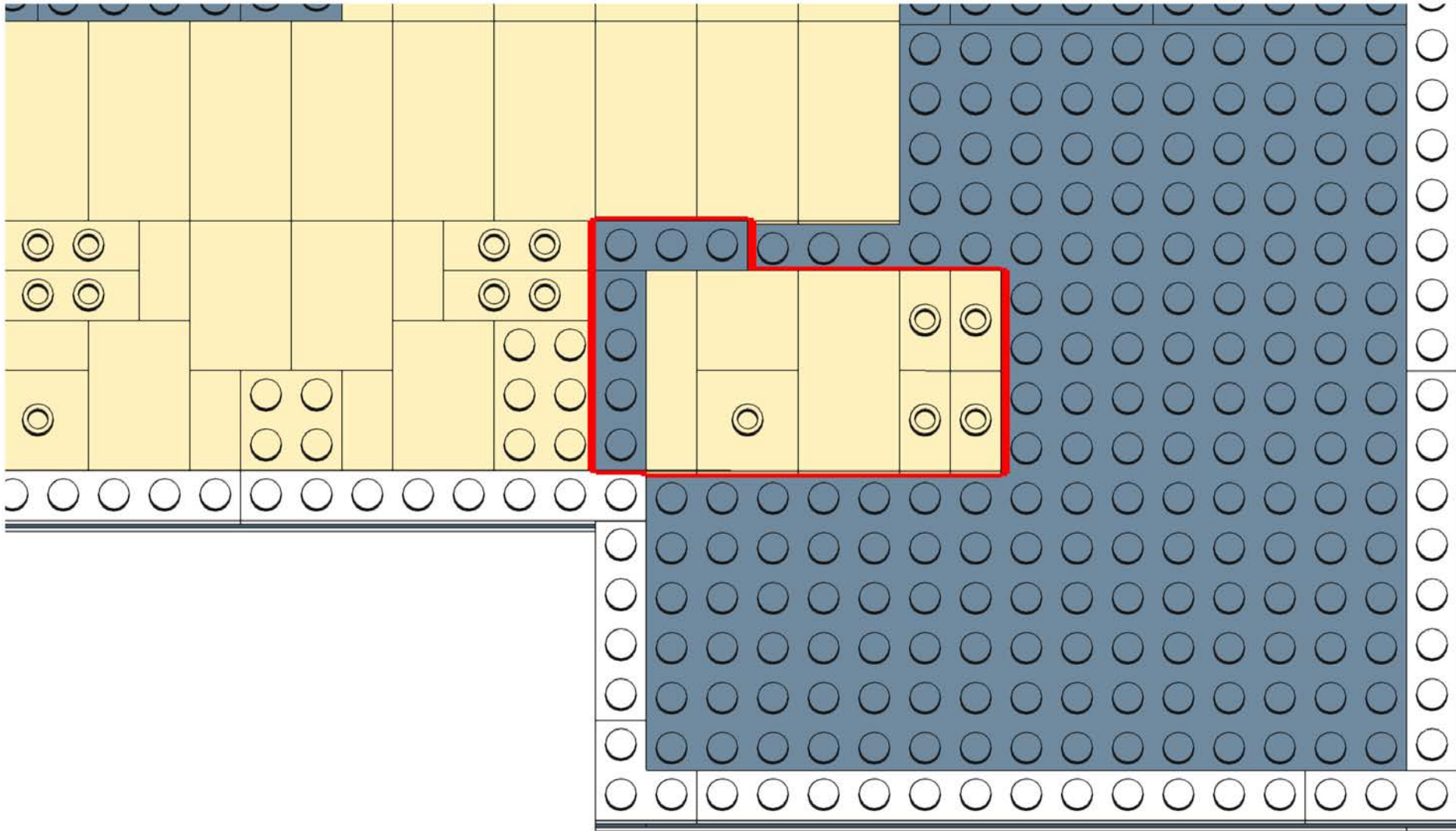

**521**



4x



1x



1x



1x

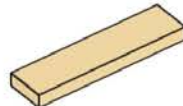

1x



1x

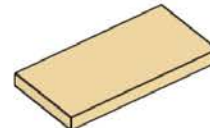

1x

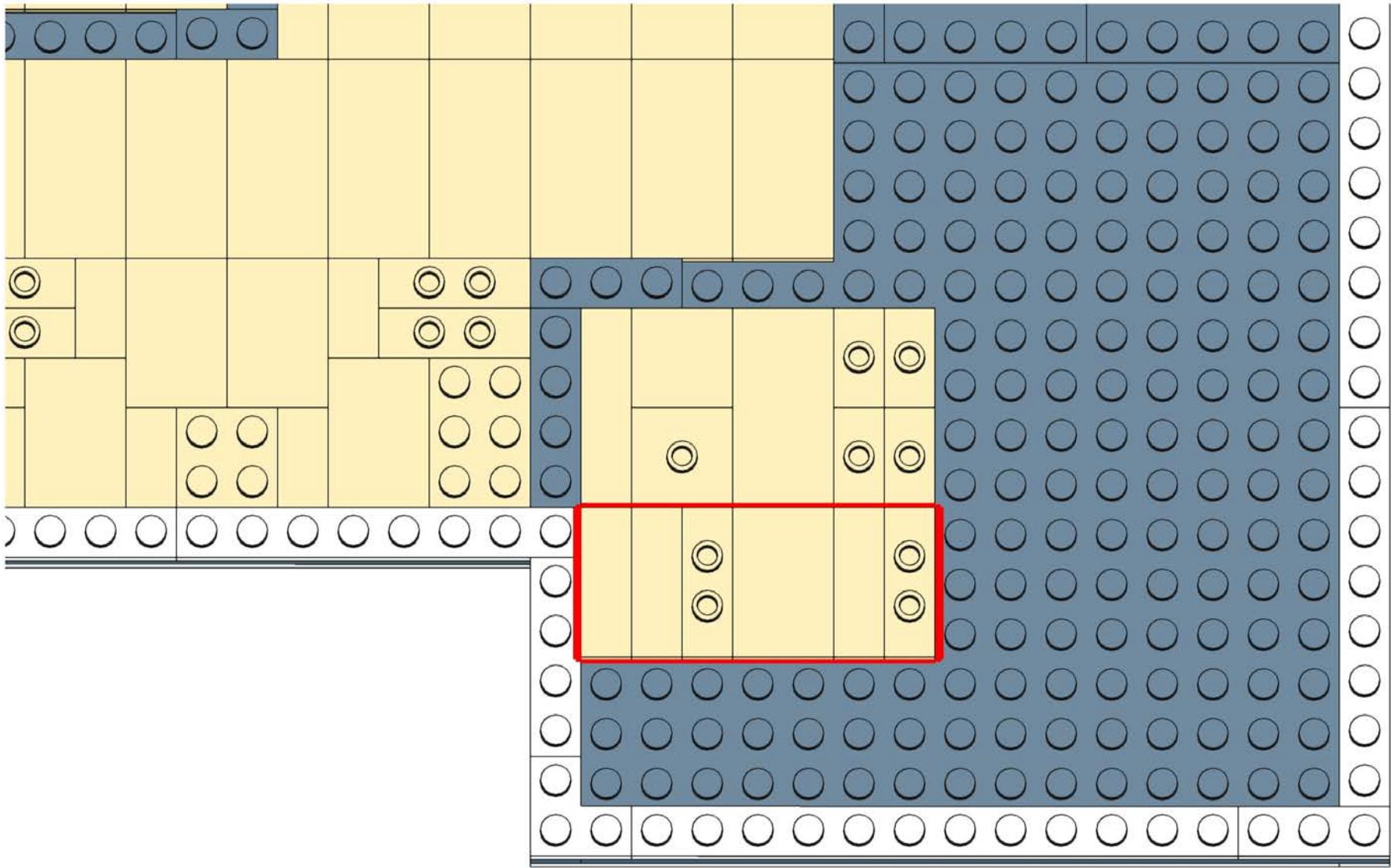

**522**

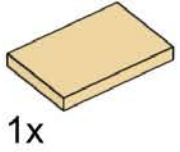
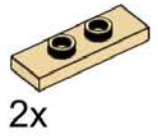
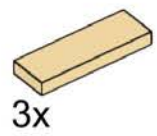



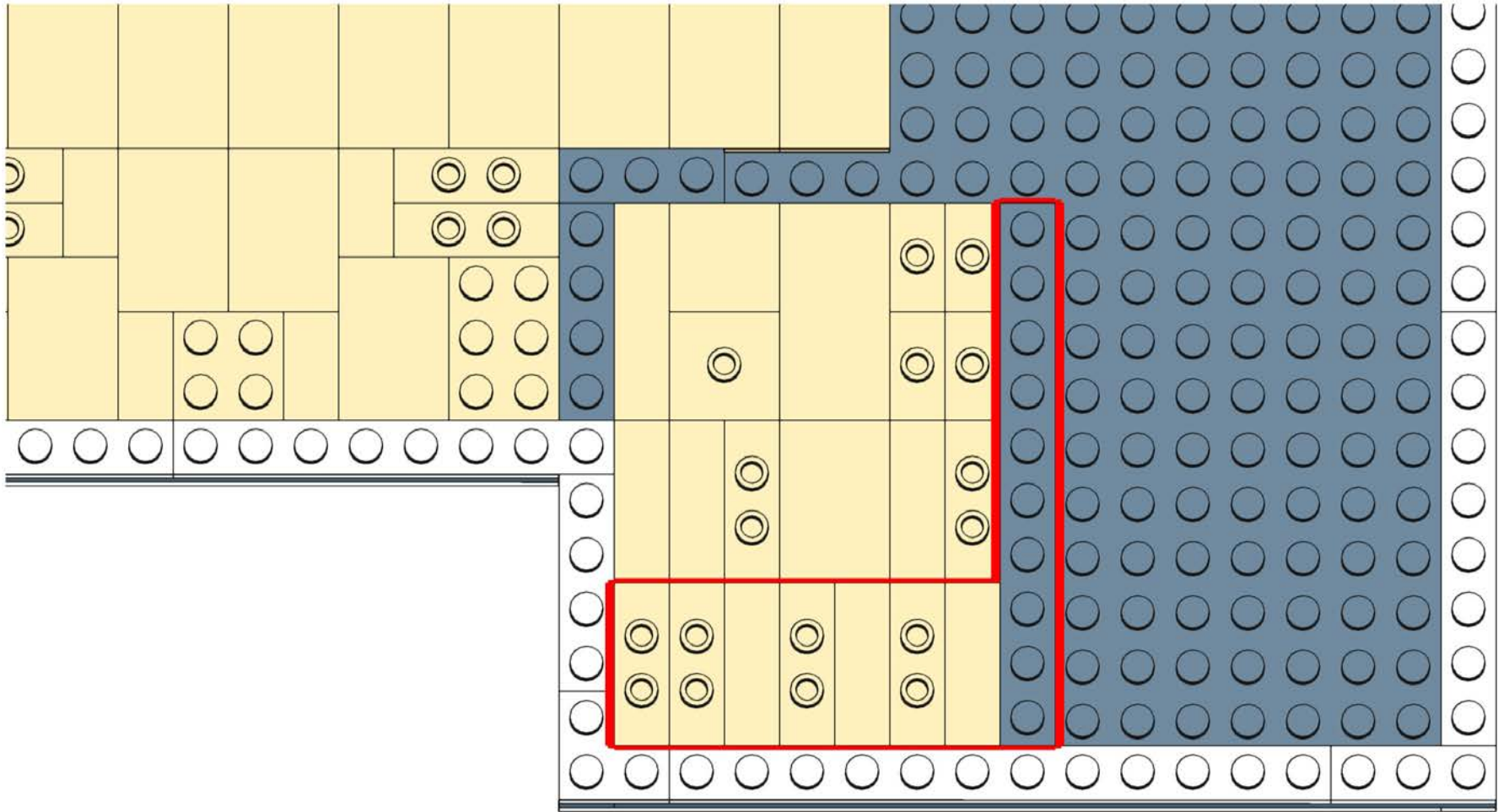

**523**

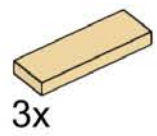

3x





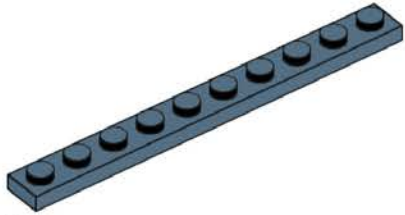



4x

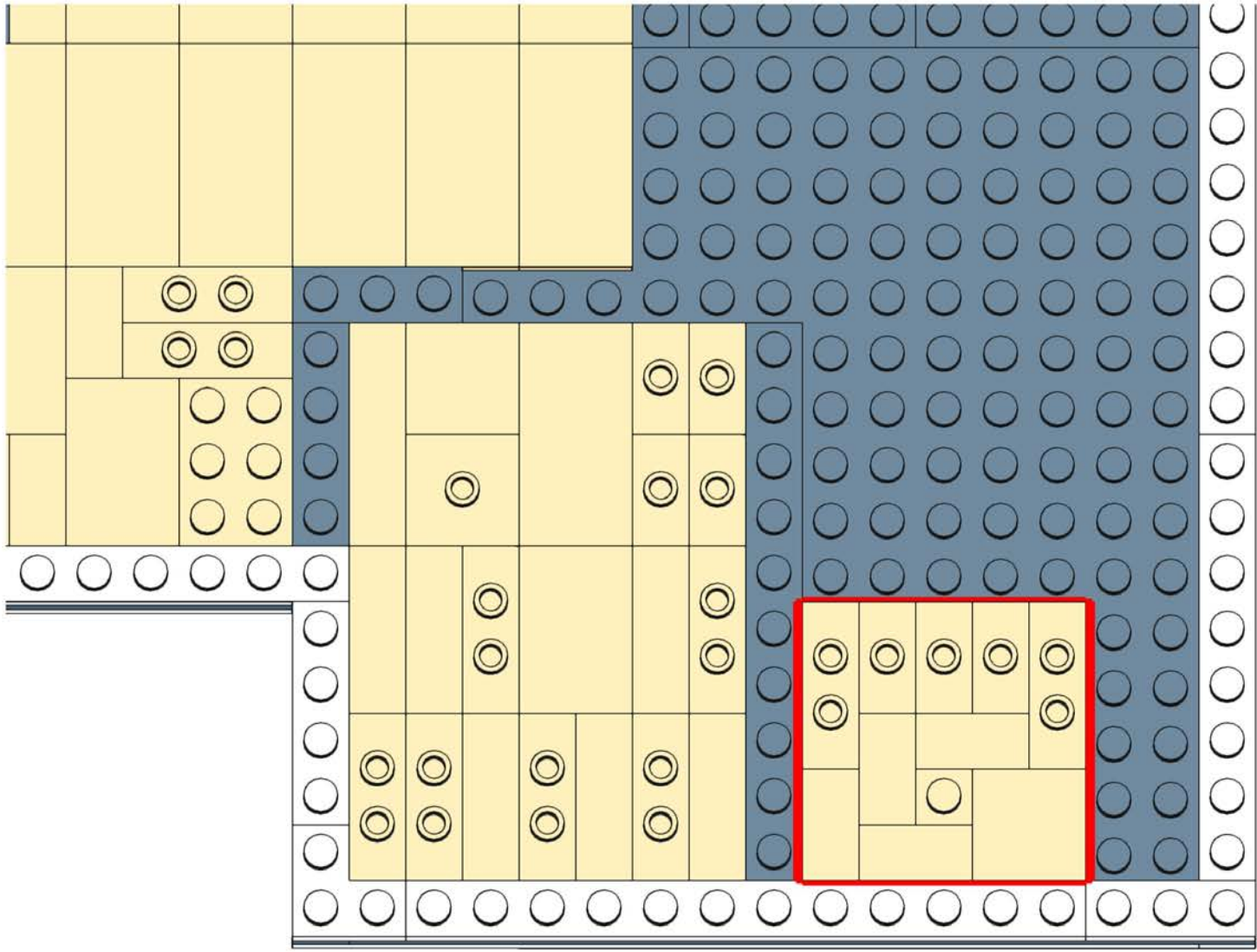

1x

# 524



- 1x 
- 4x 
- 3x 
- 1x 
- 2x 

# 525

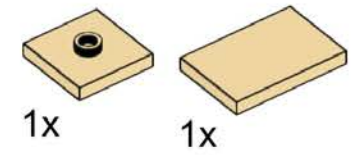
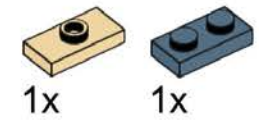
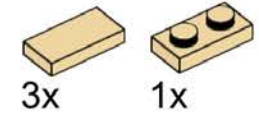
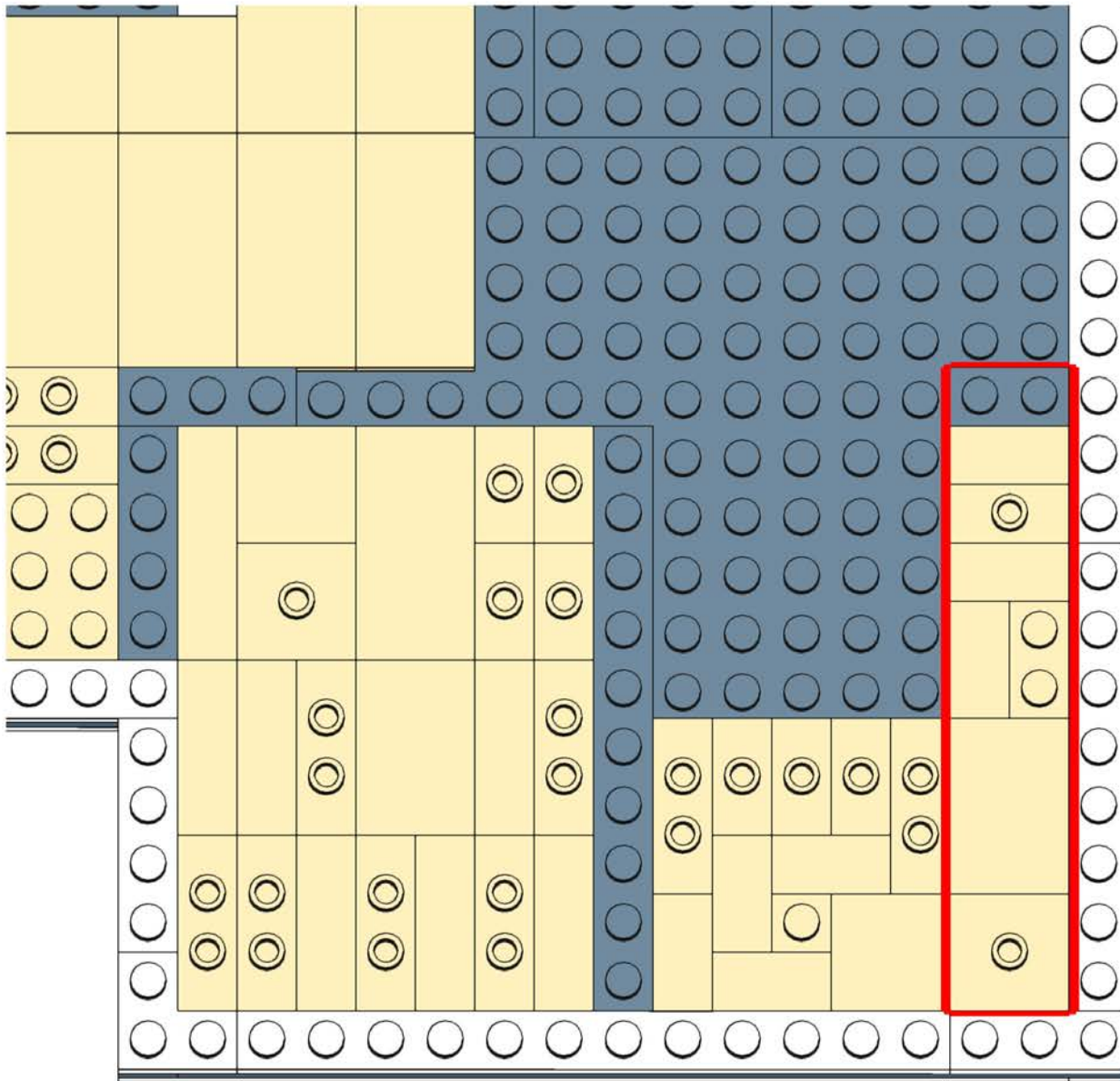

# 526

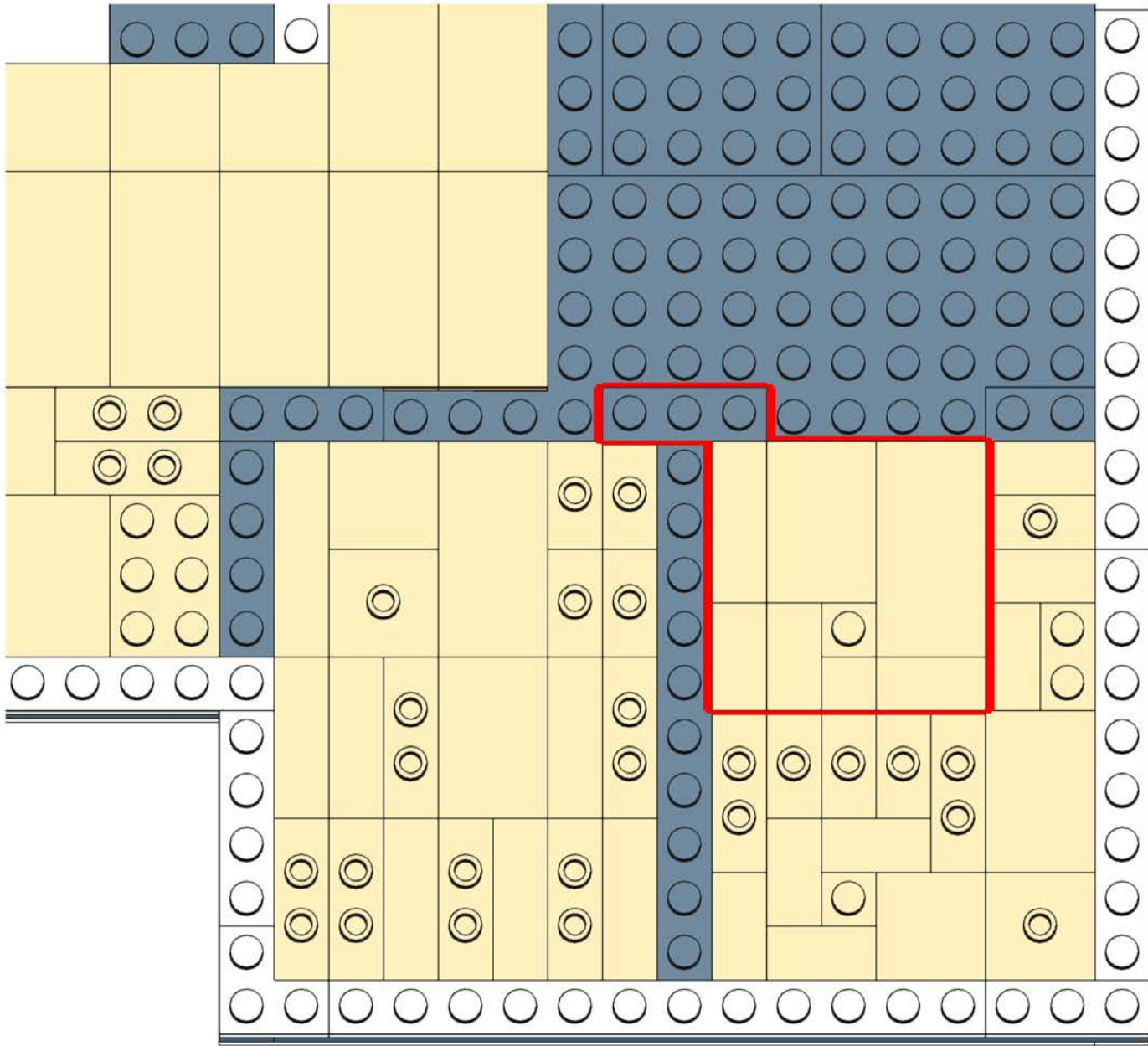

- 1x 1x 3x
- 1x 1x
- 1x 1x
- 1x 1x

# 527

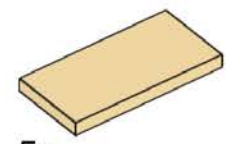

5x



1x

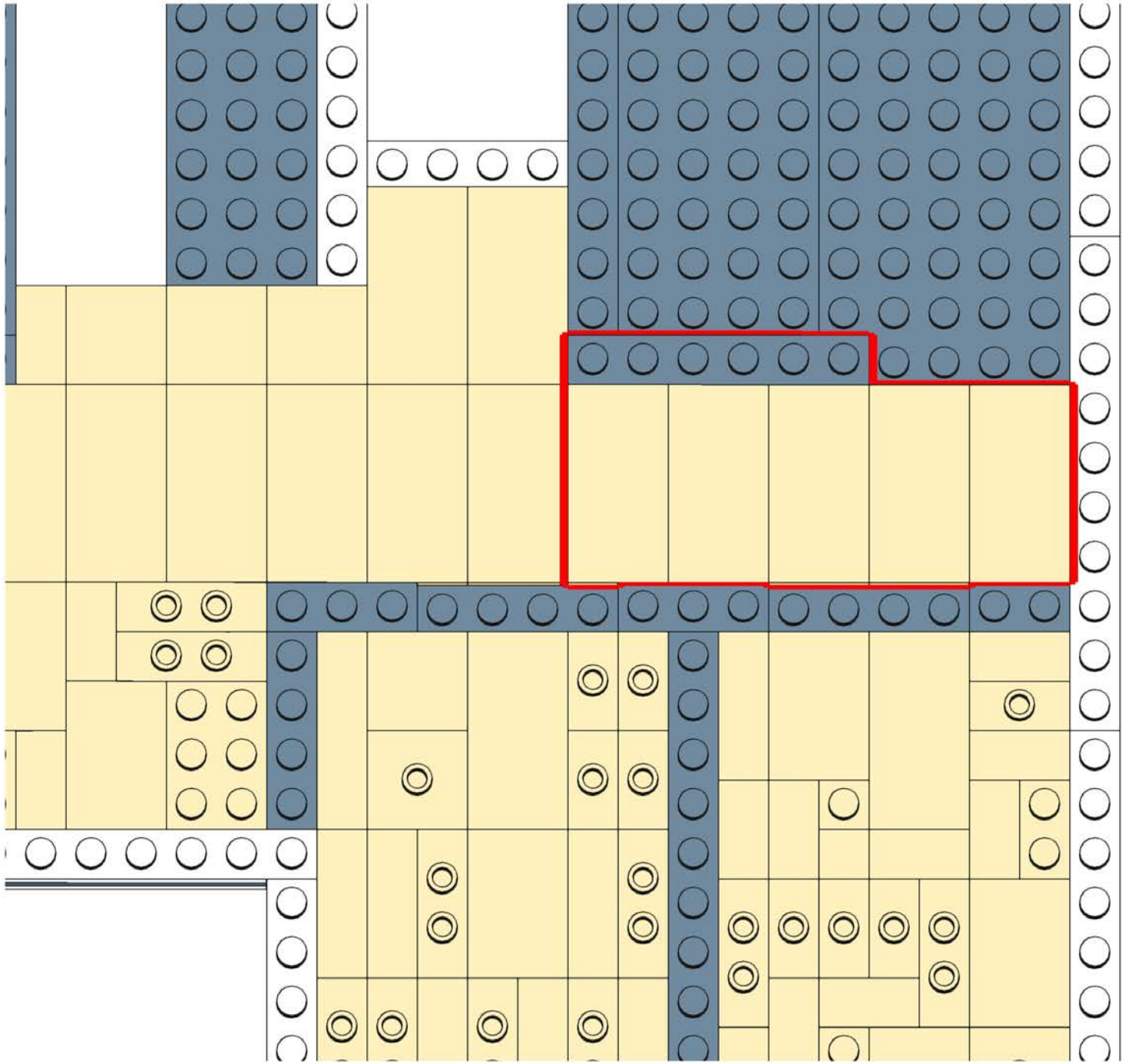

# 528

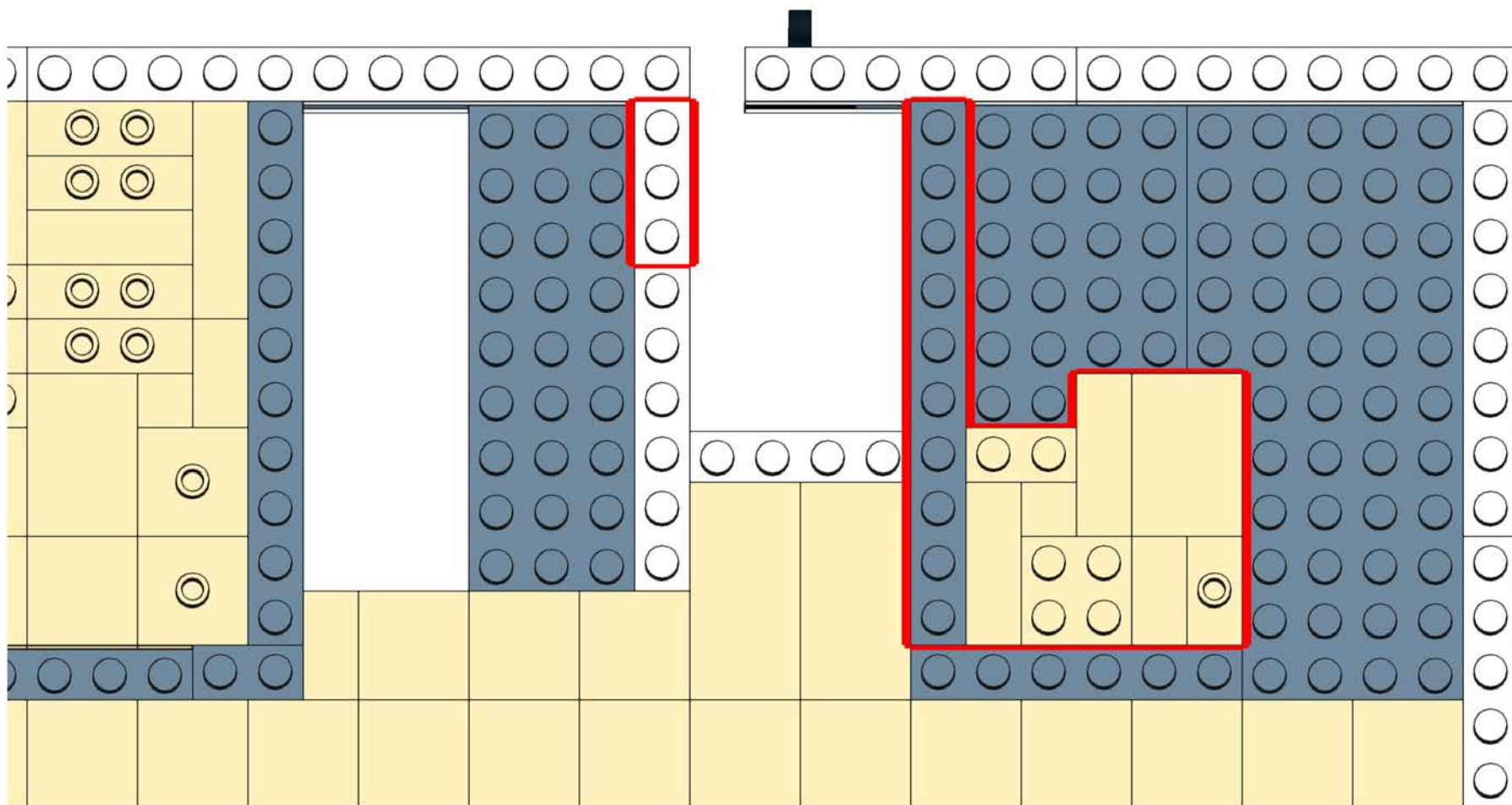
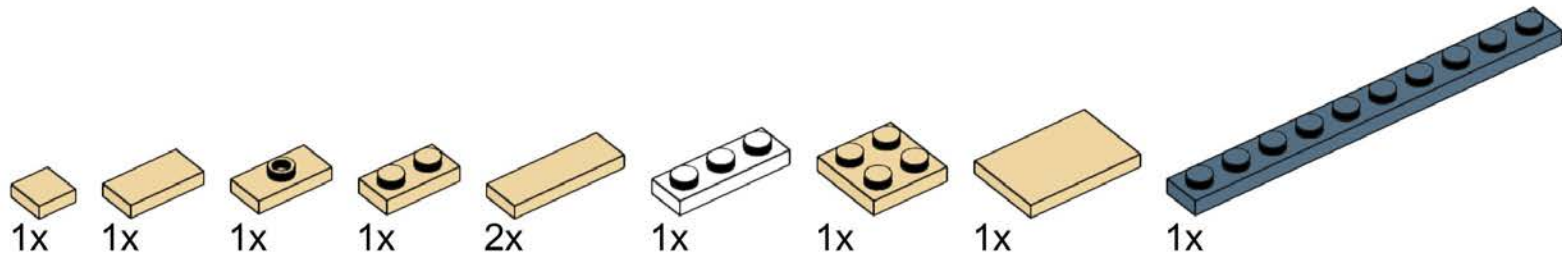

# 529

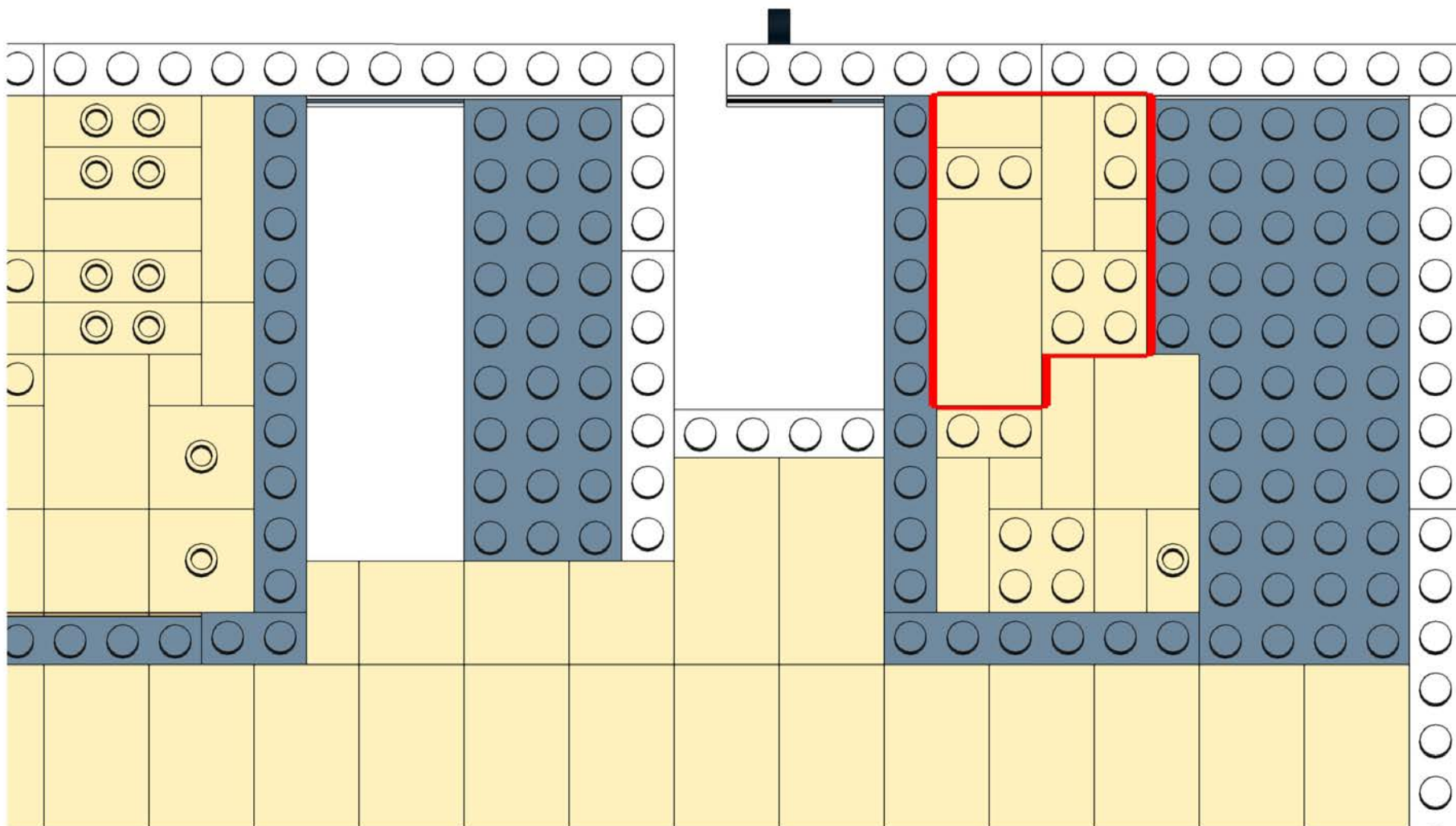
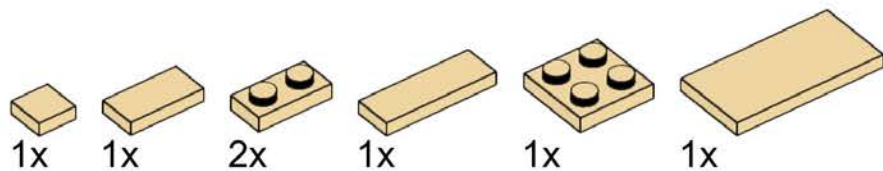

# 530

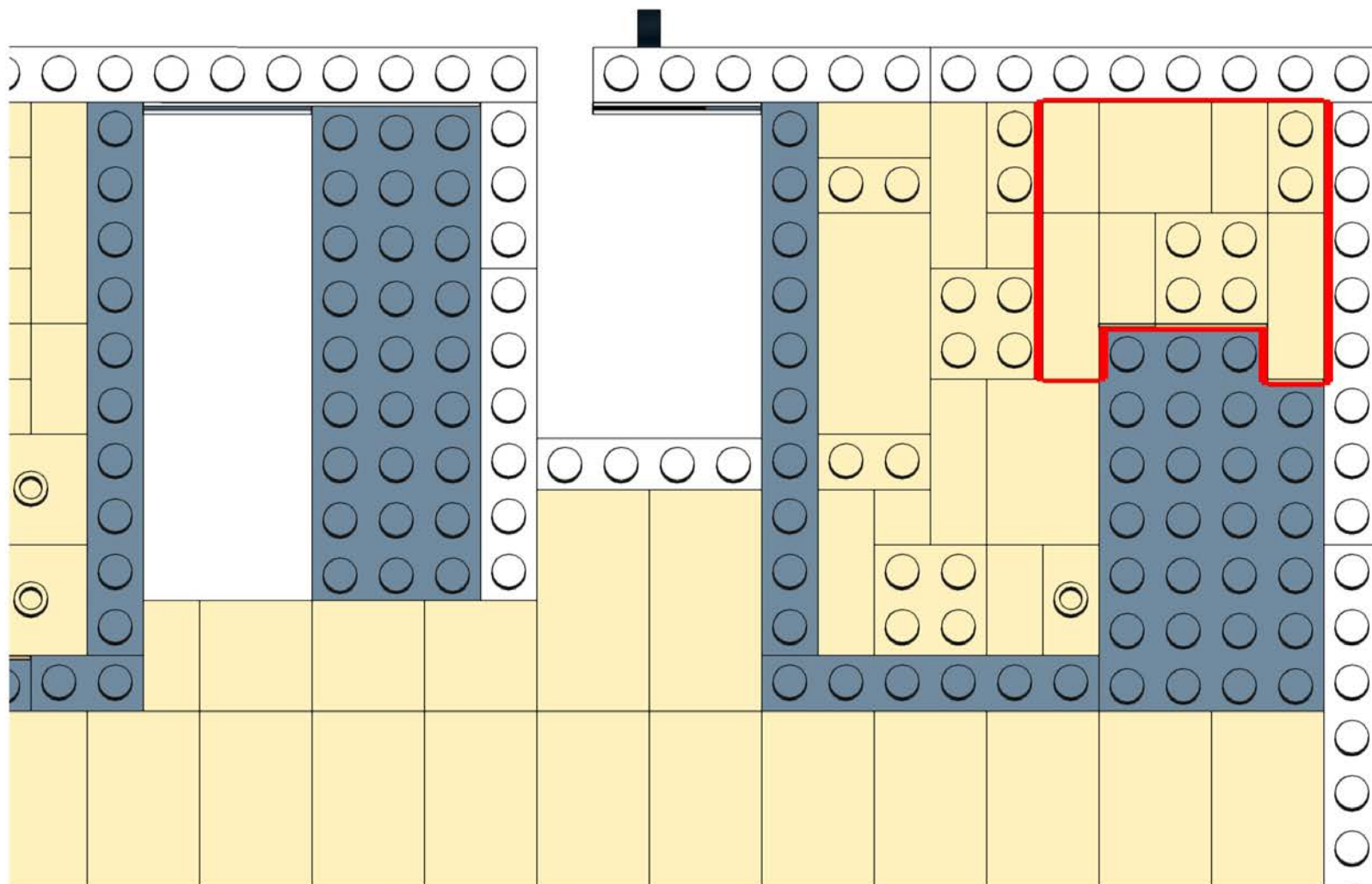
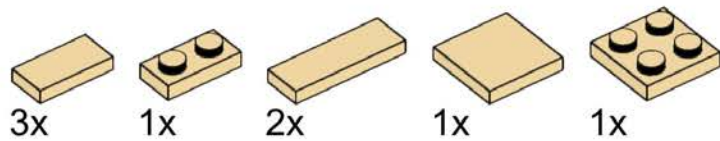



# 531

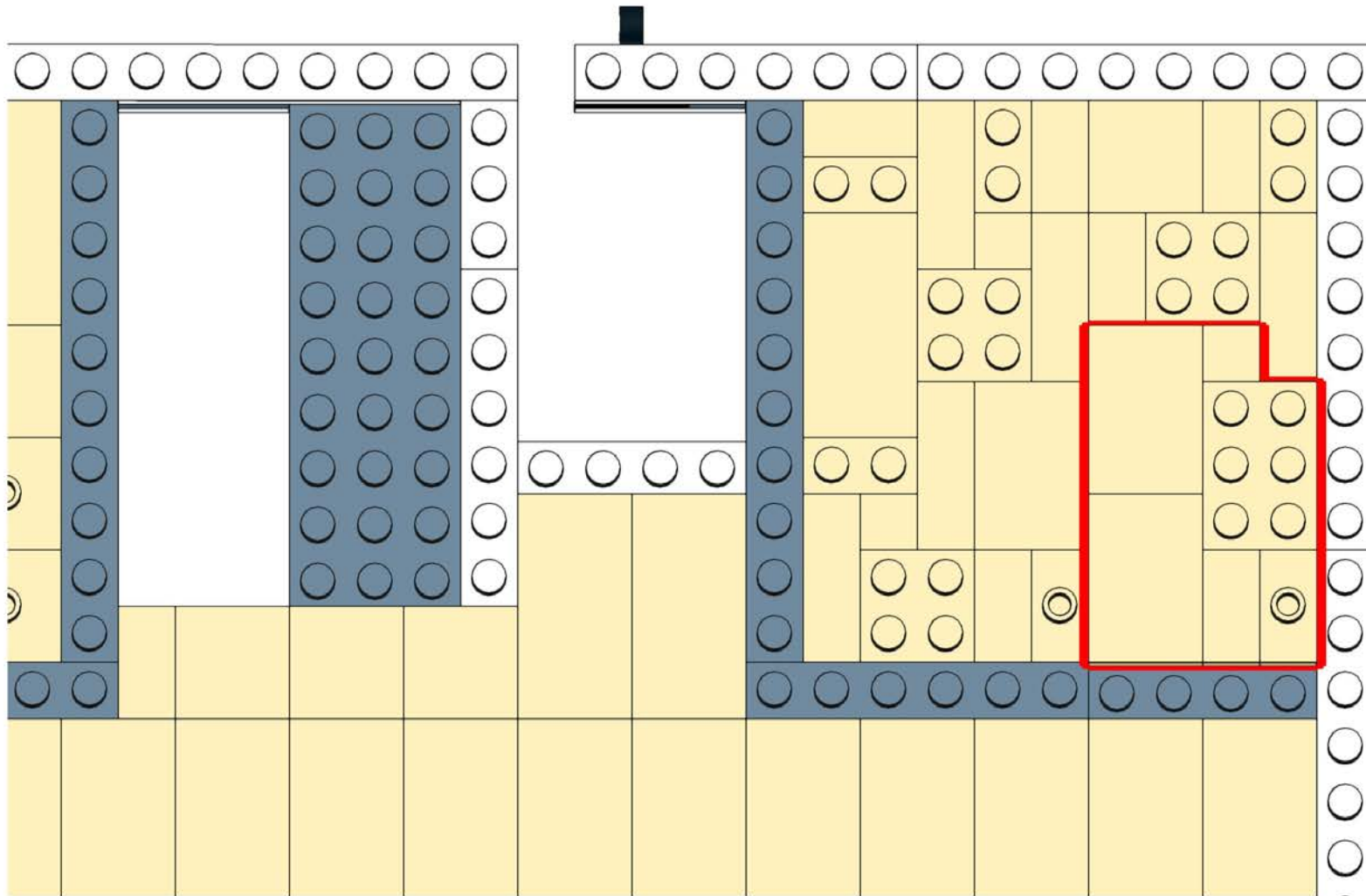
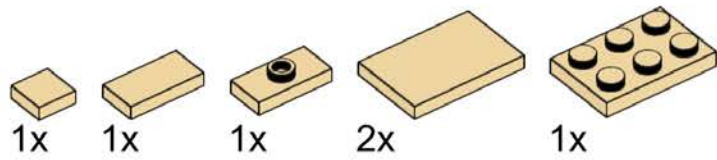

# 532

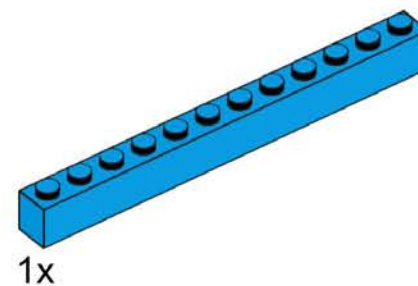
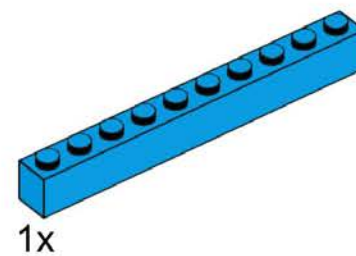
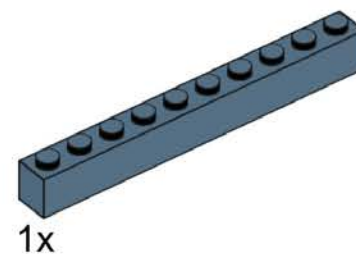
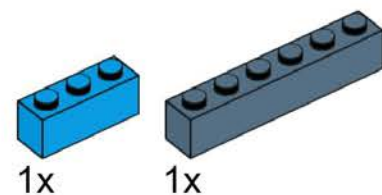
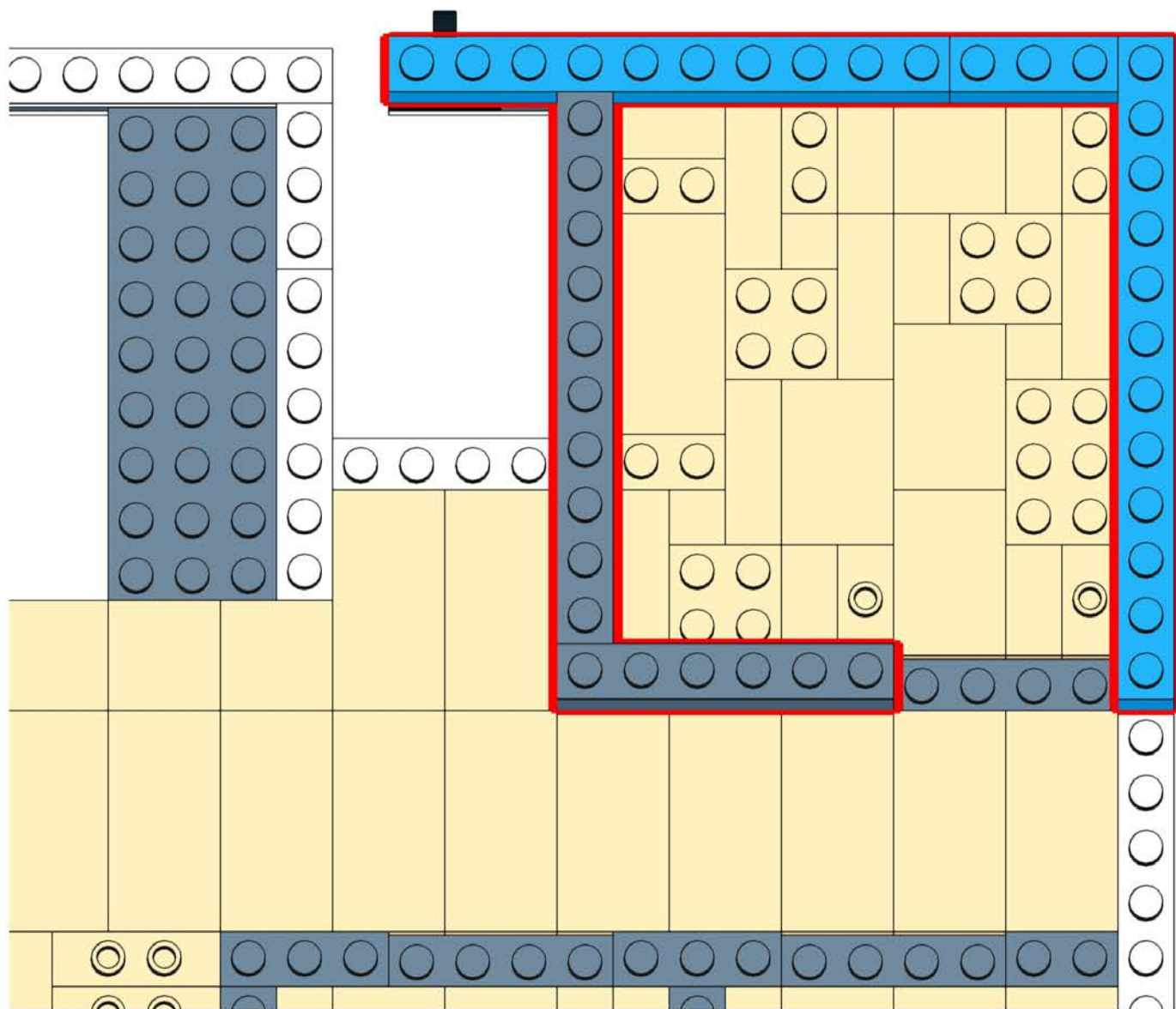

# 533

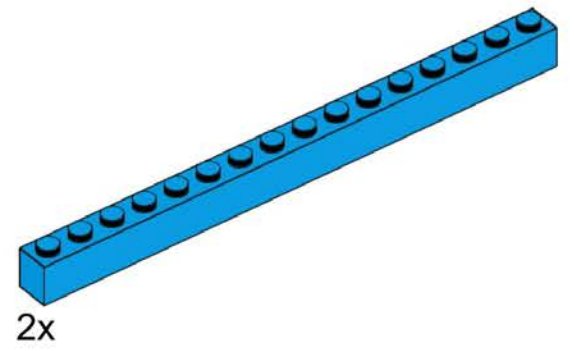
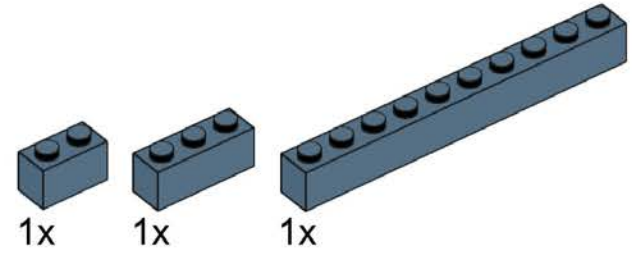
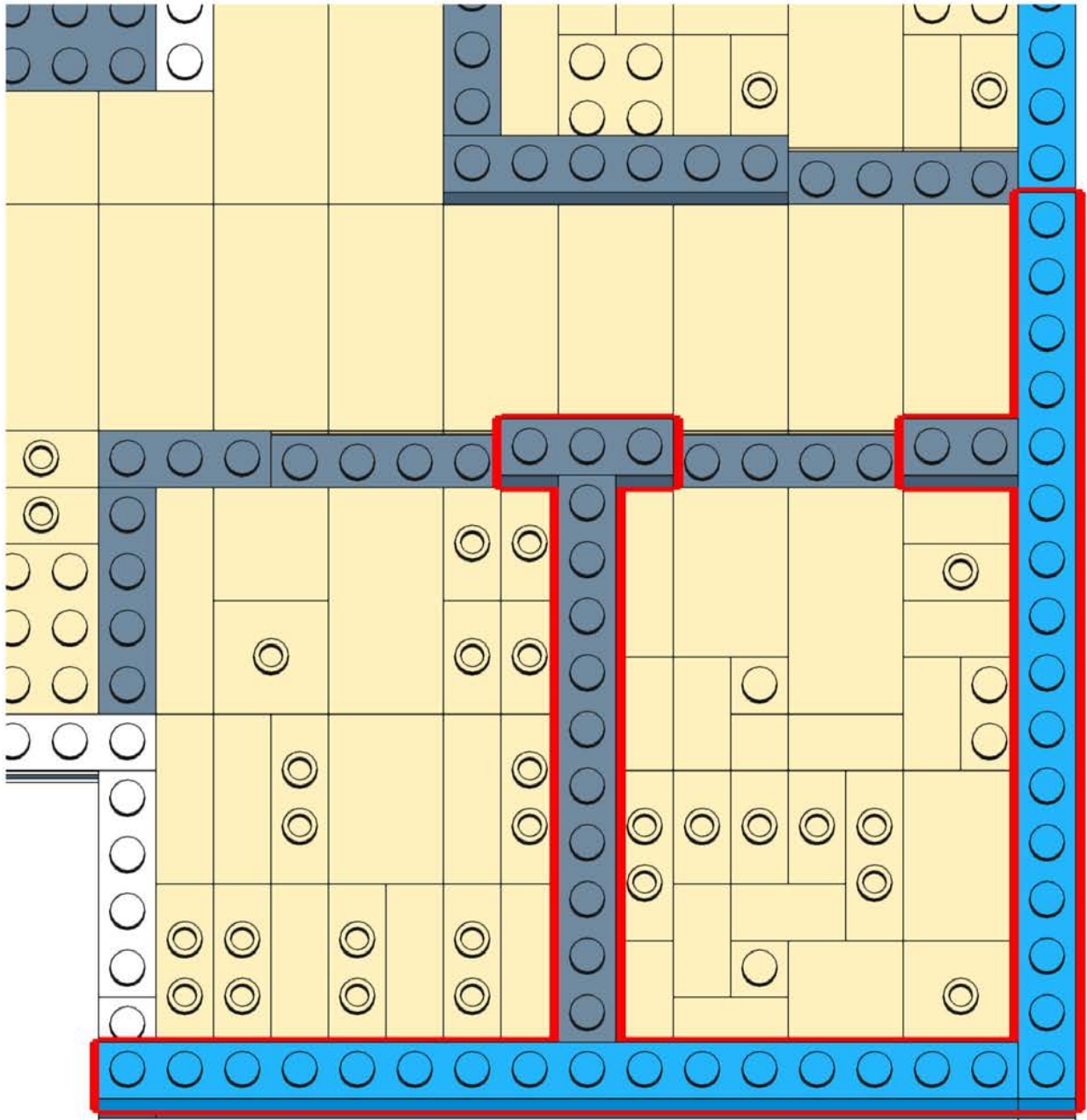

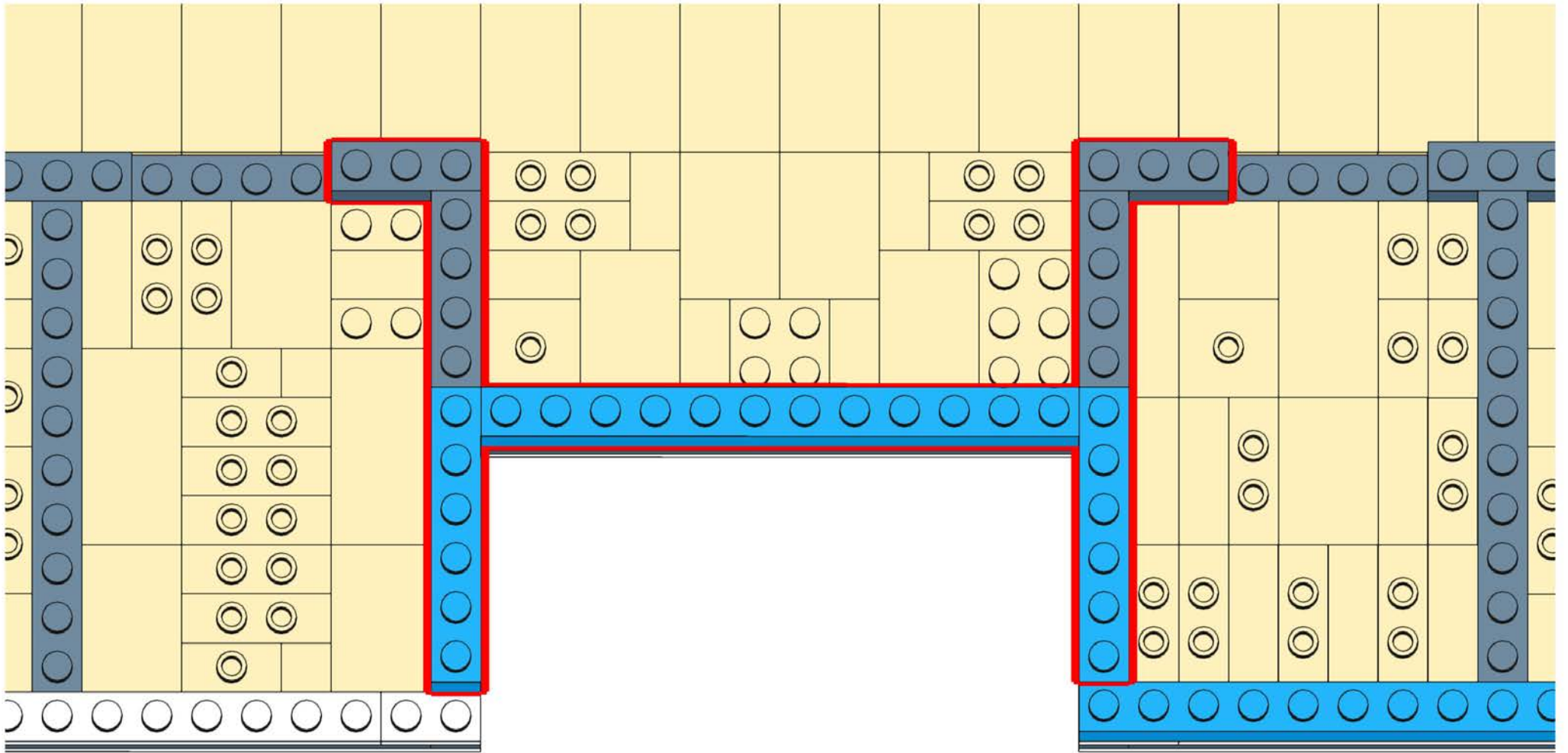

**534**

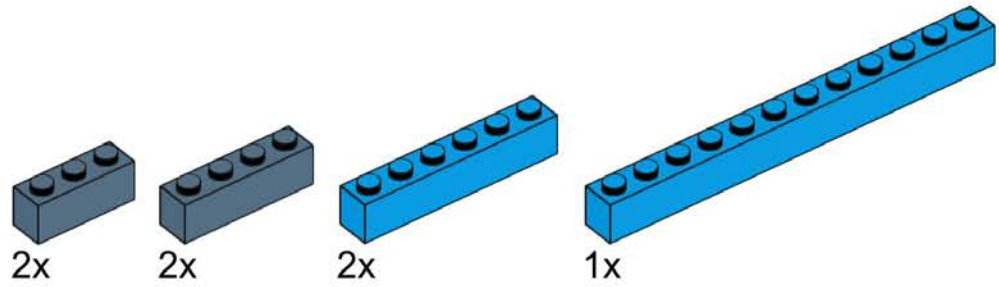

# 535

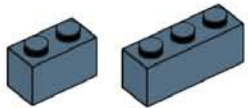

1x

1x

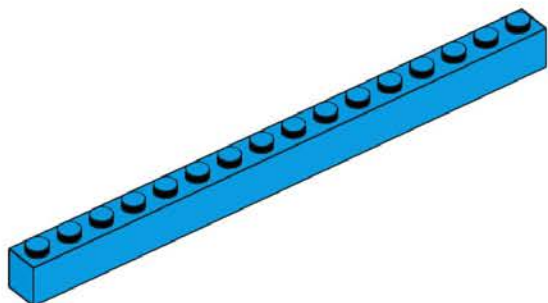

2x

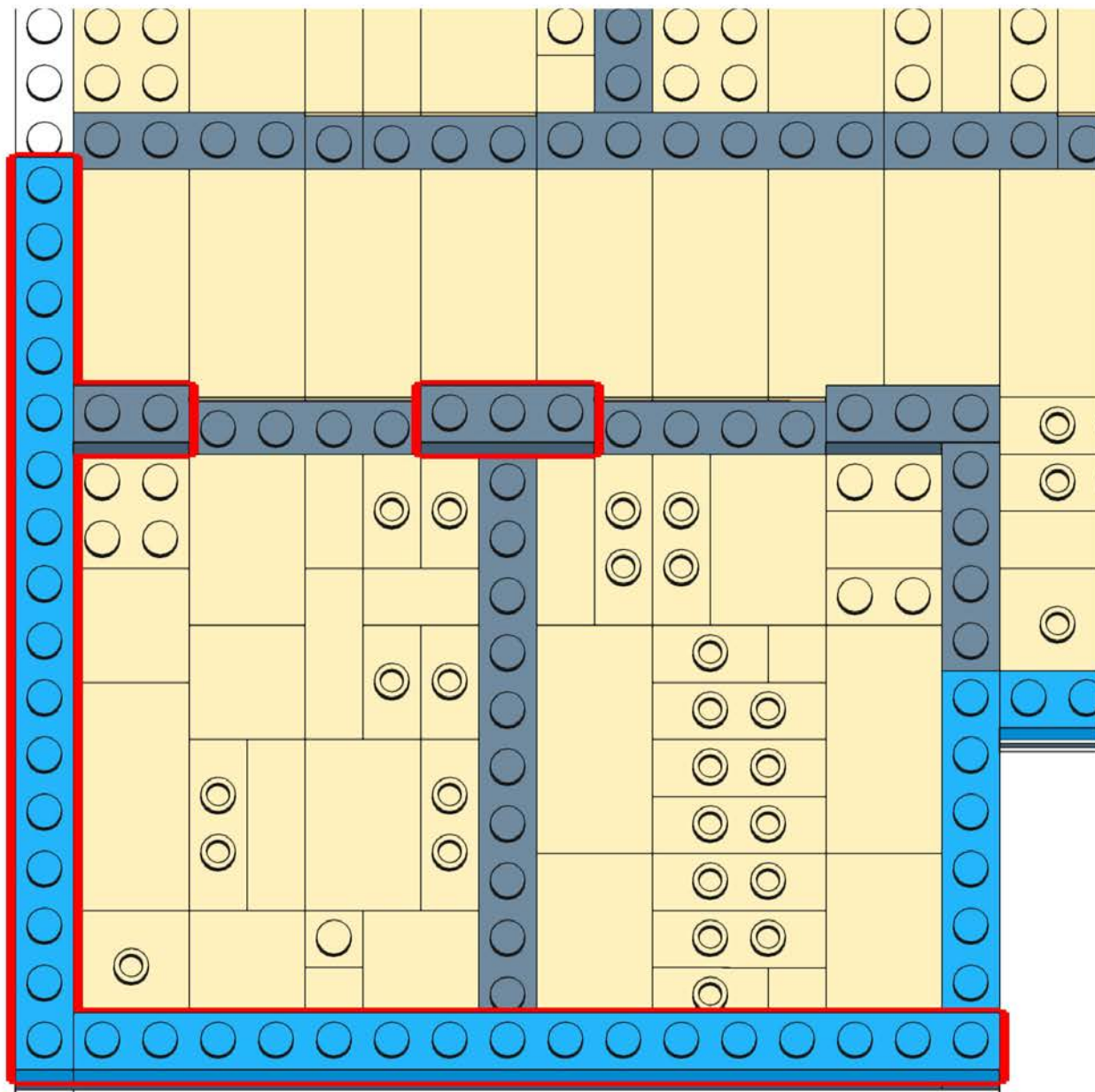

# 536

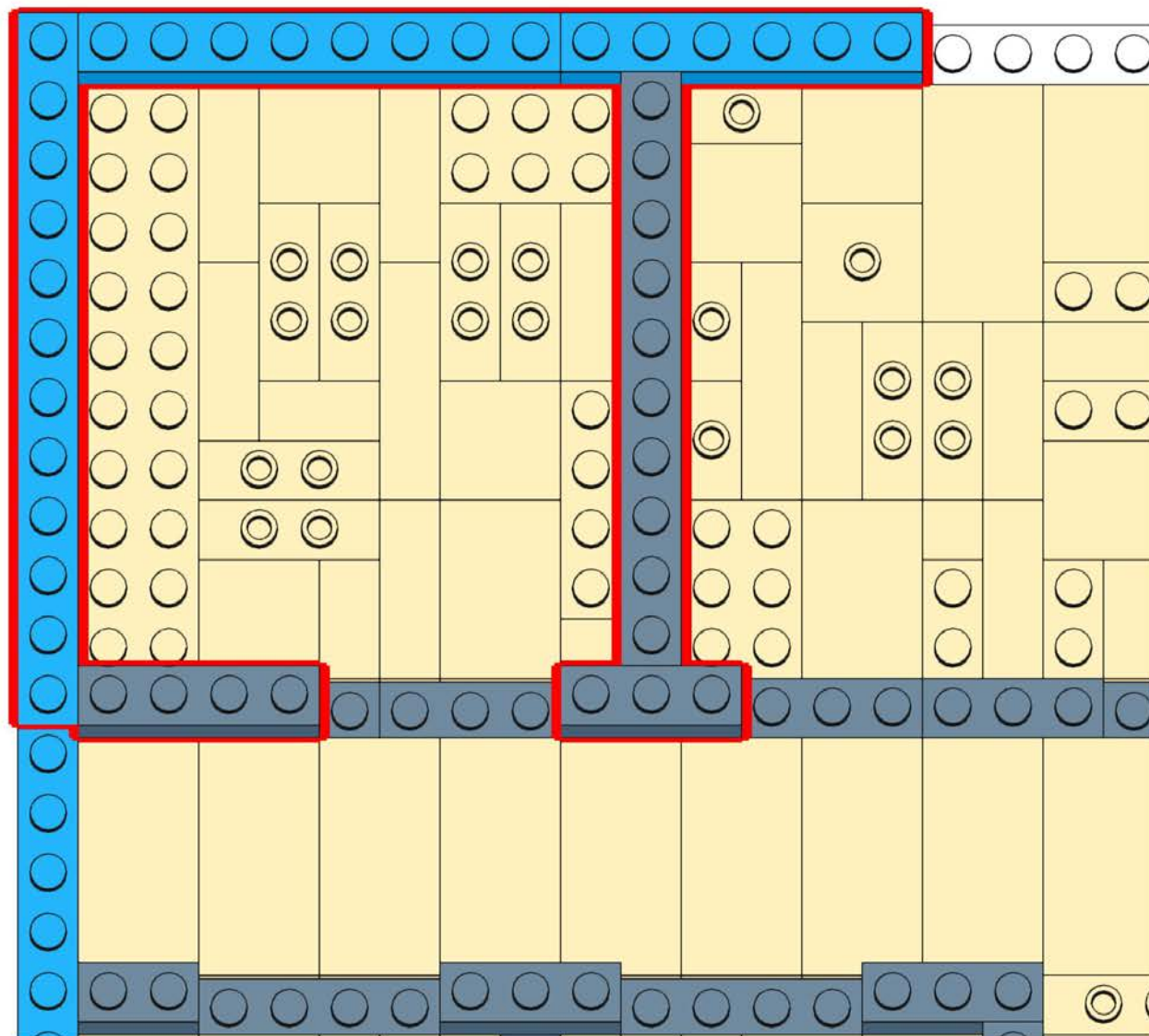
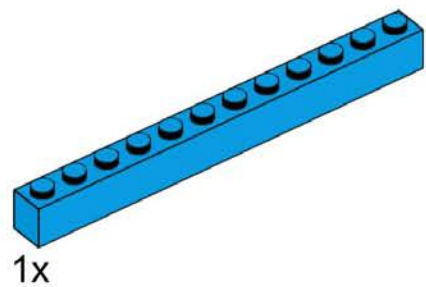
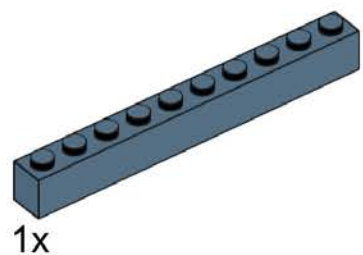
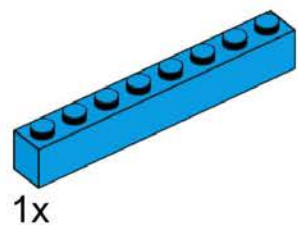
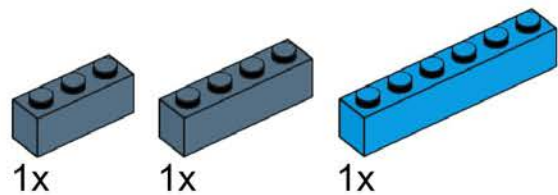

# 537

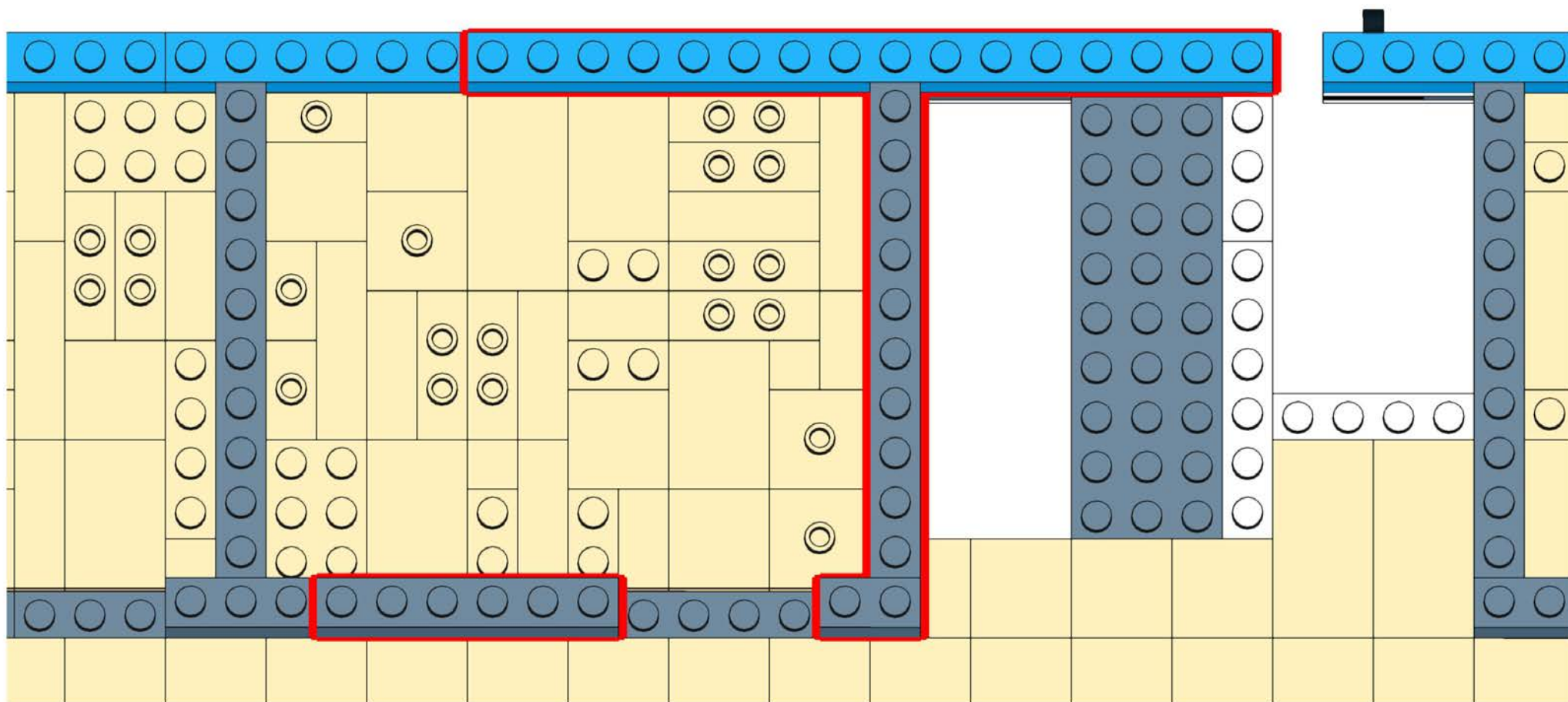
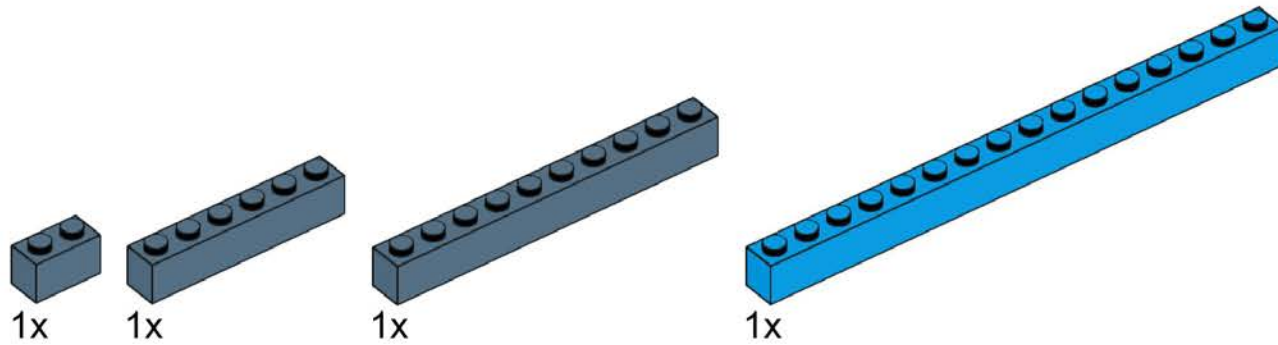

# 538

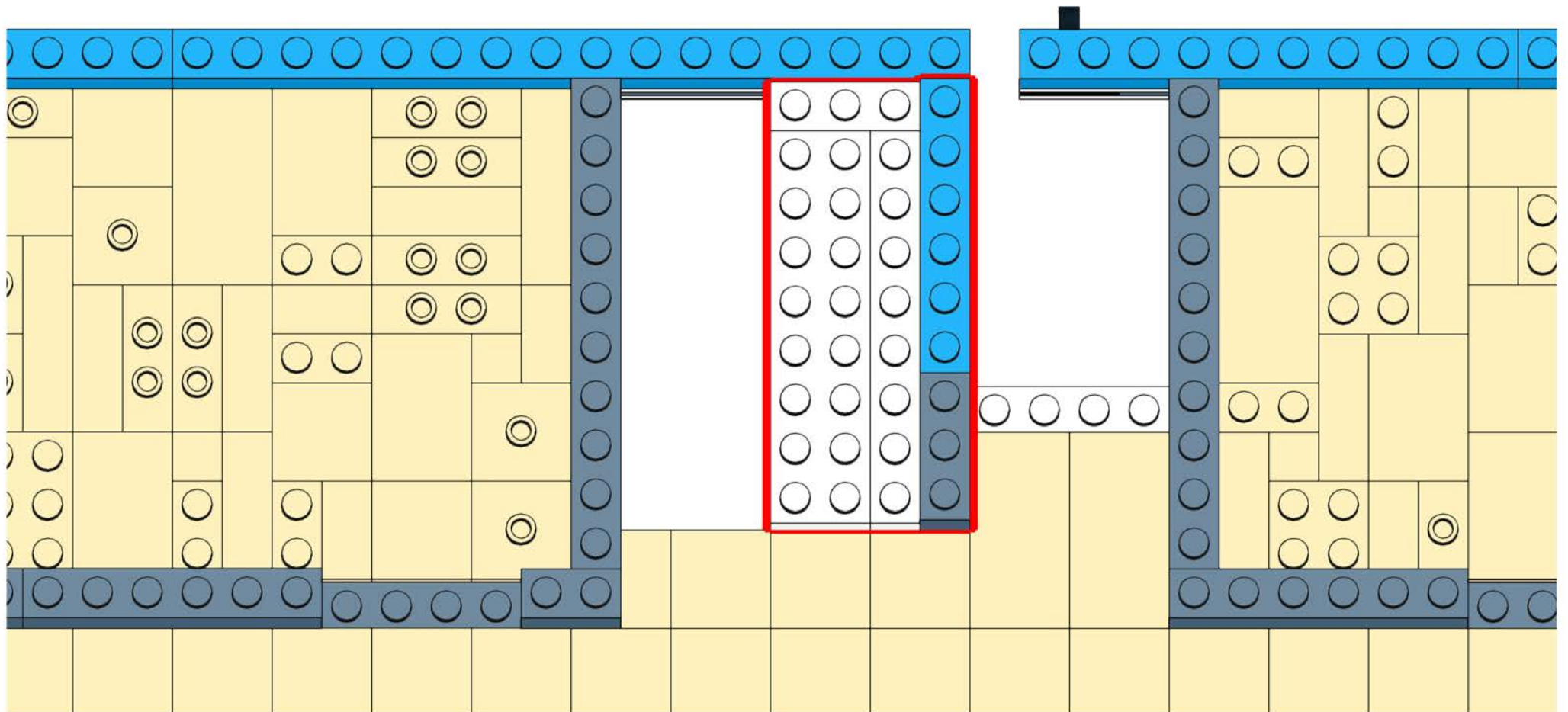
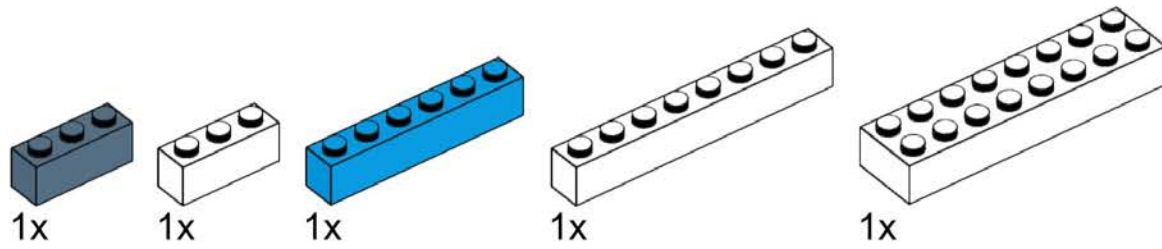



# 539

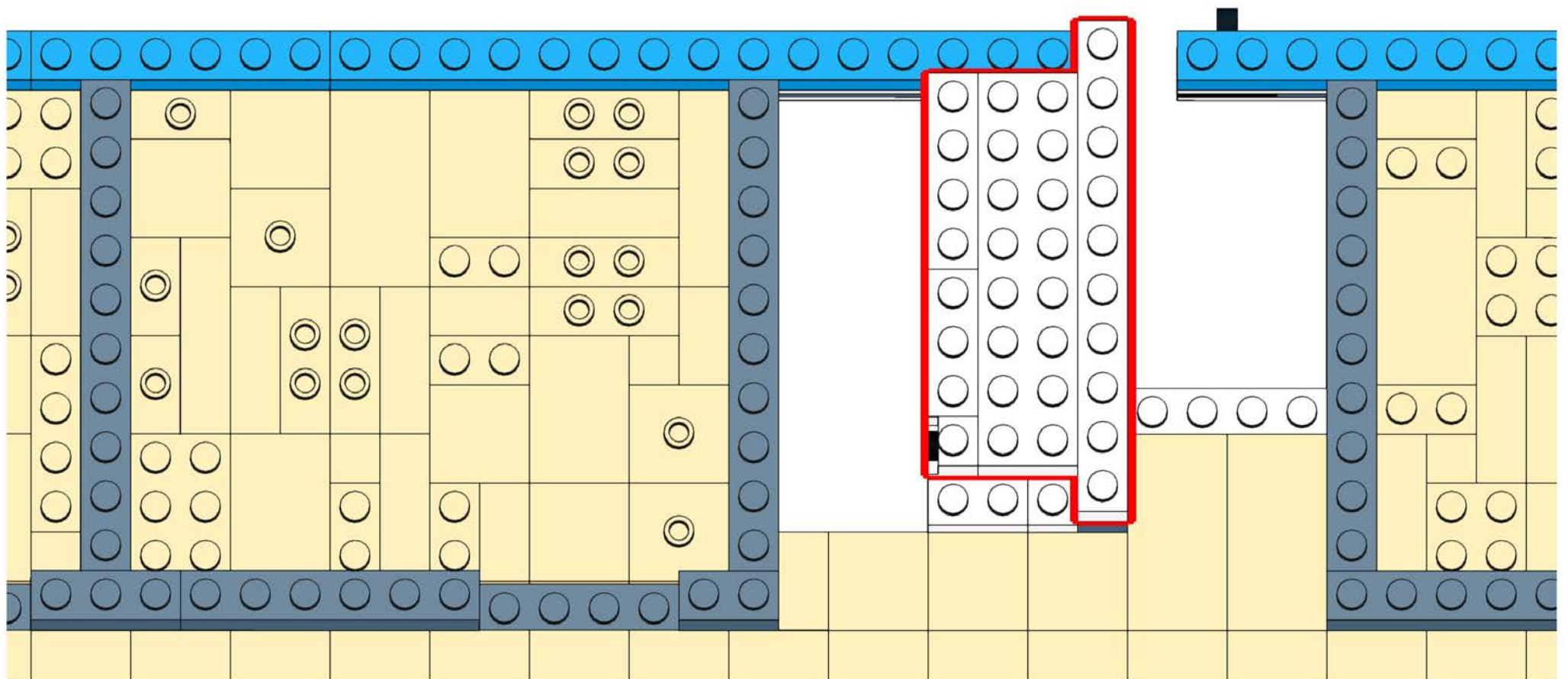
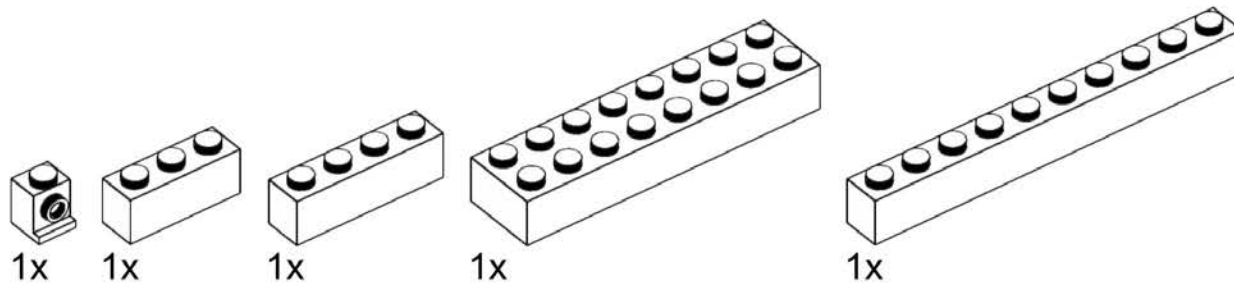

# 540

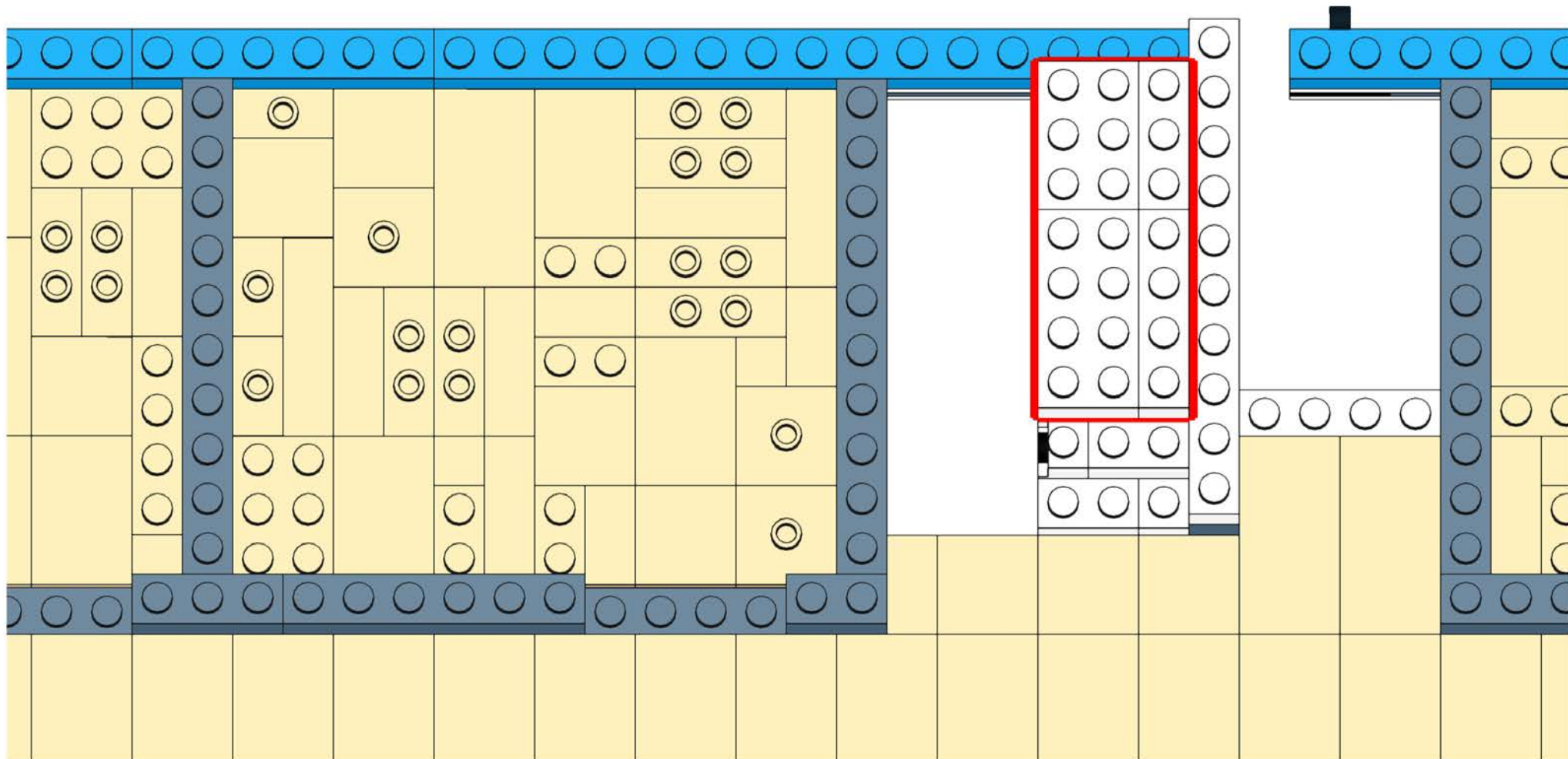
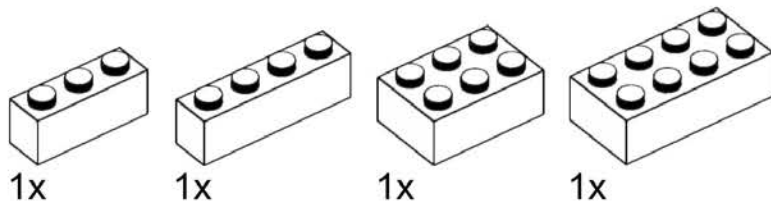

# 541

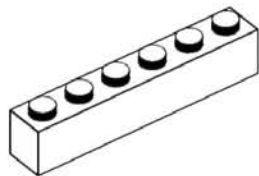

1x

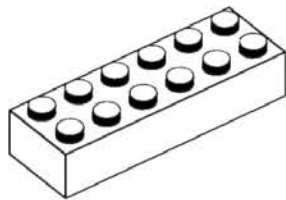

1x

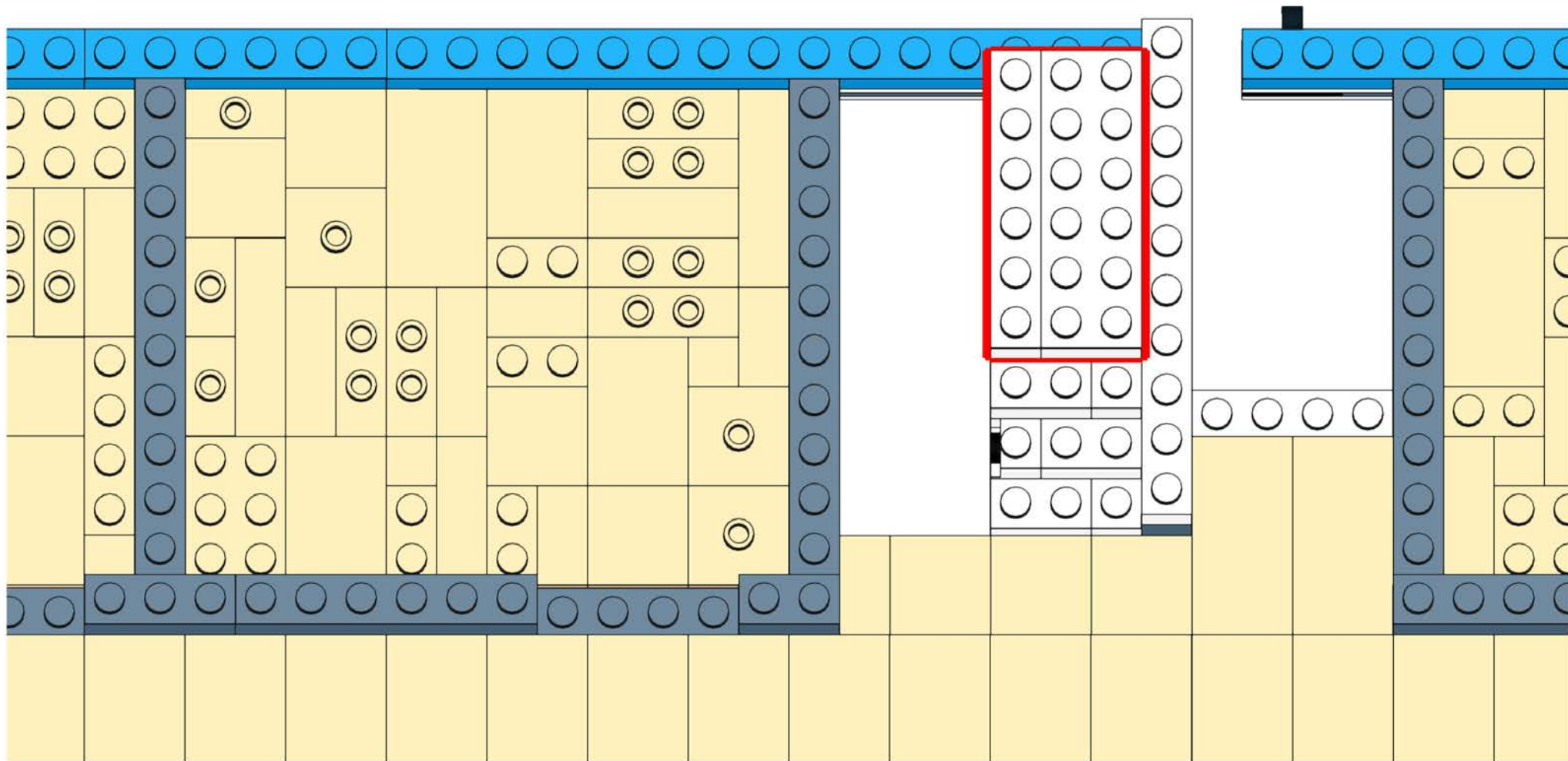

# 542

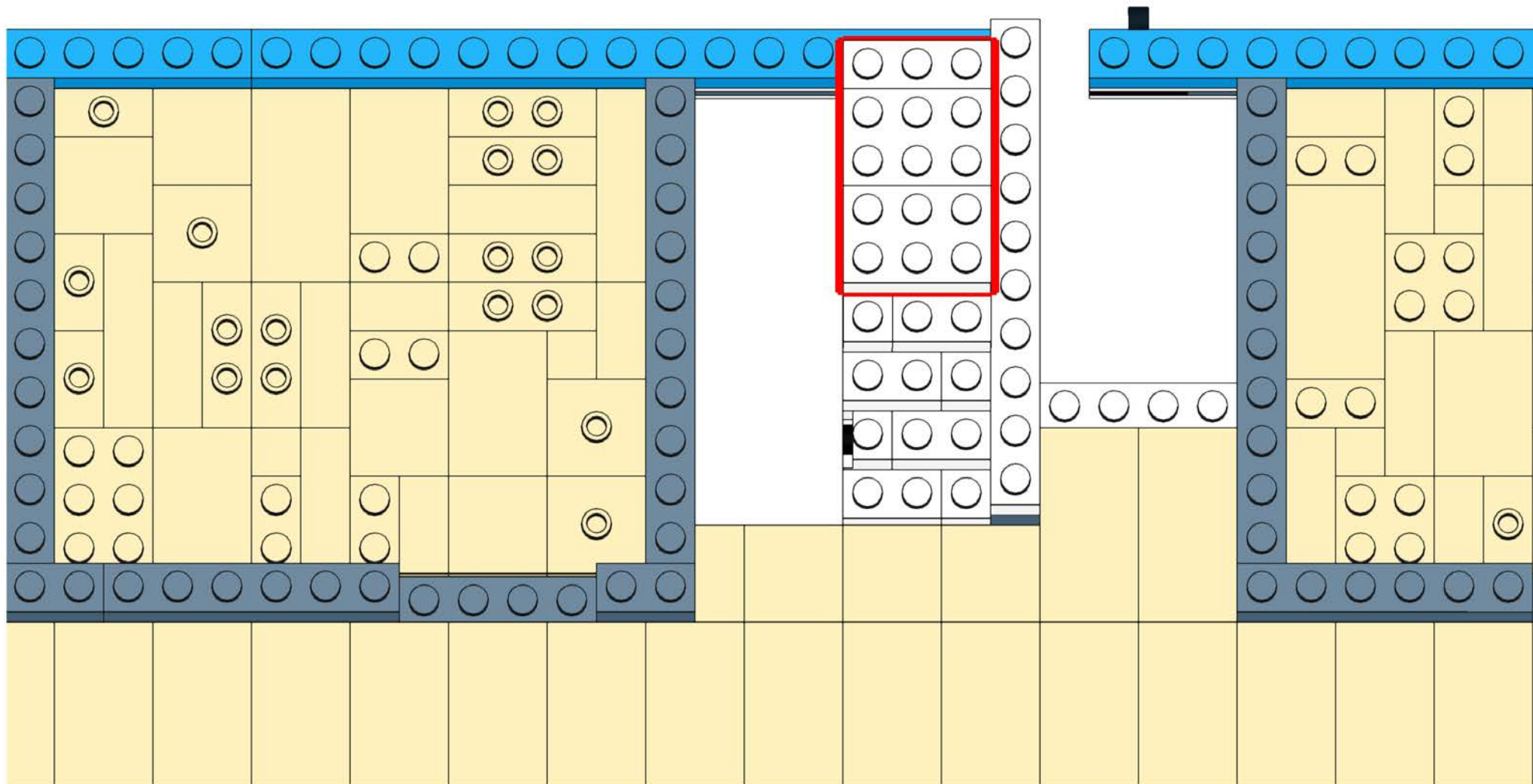
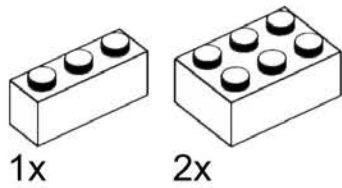

# 543

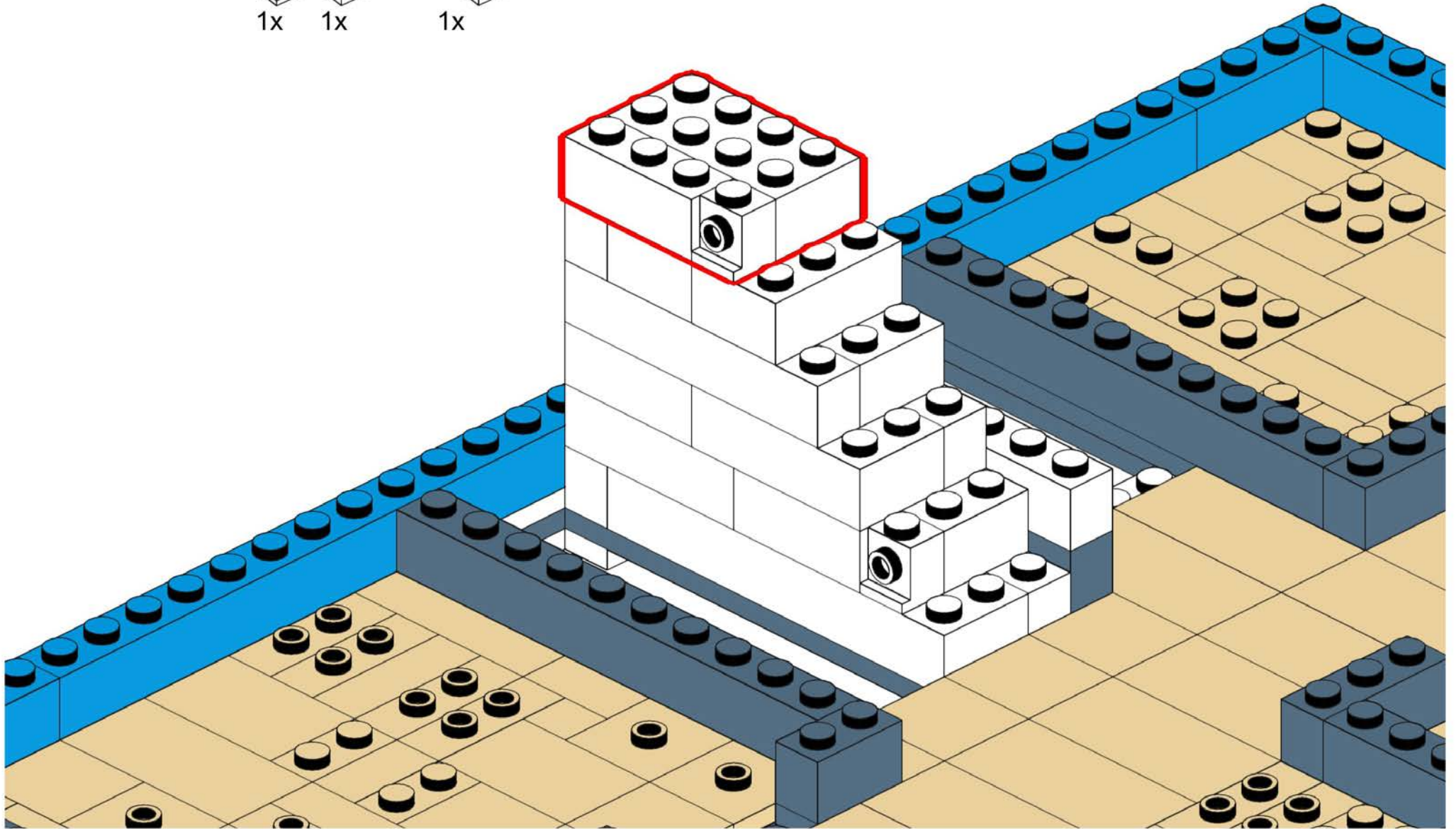
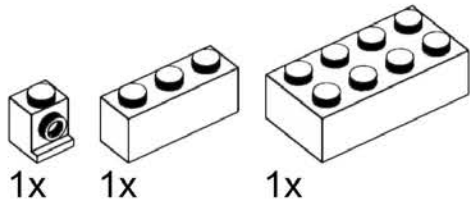

# 544

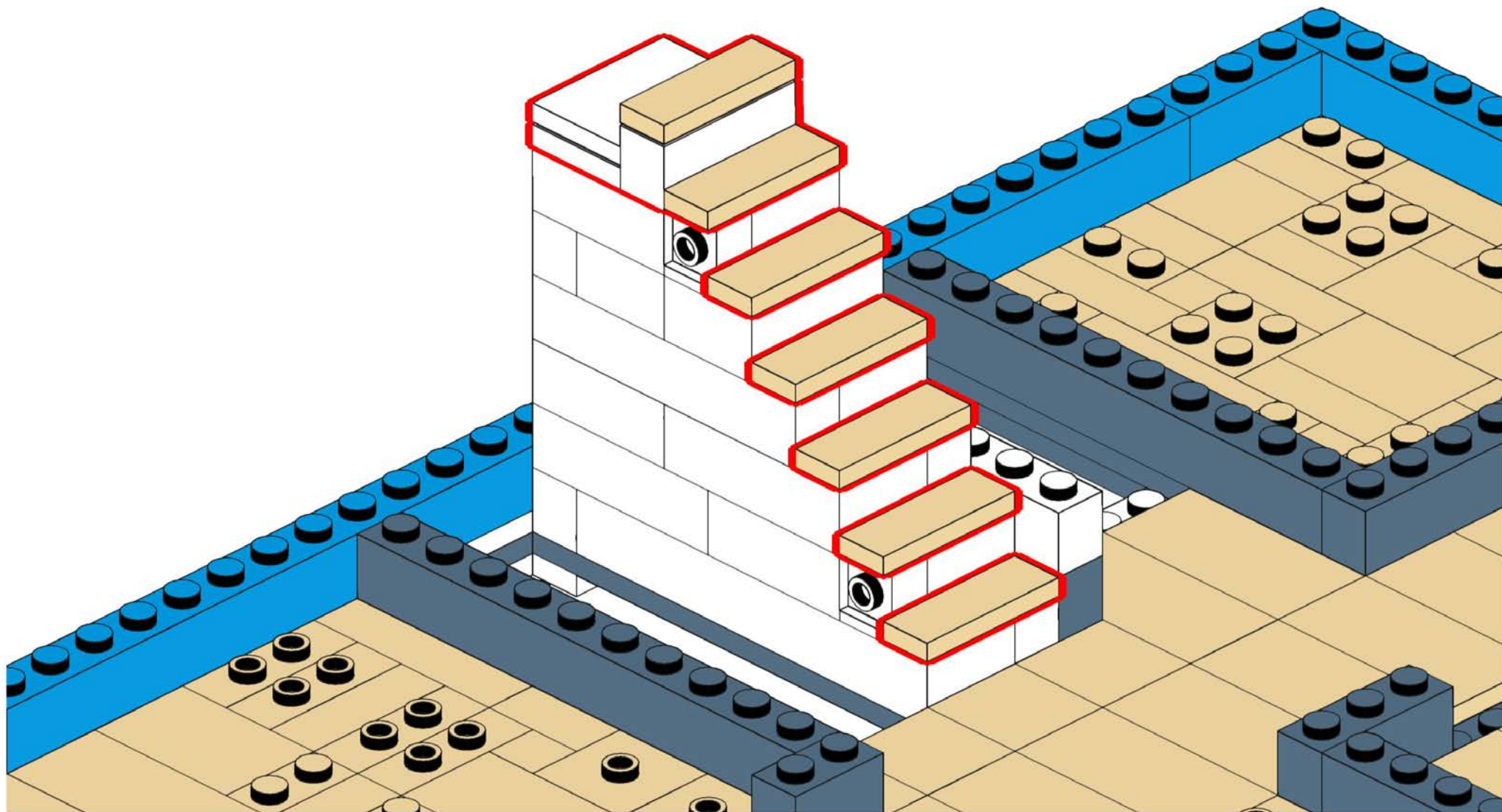
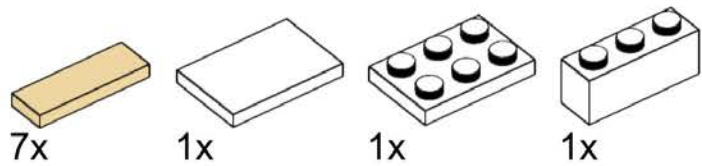

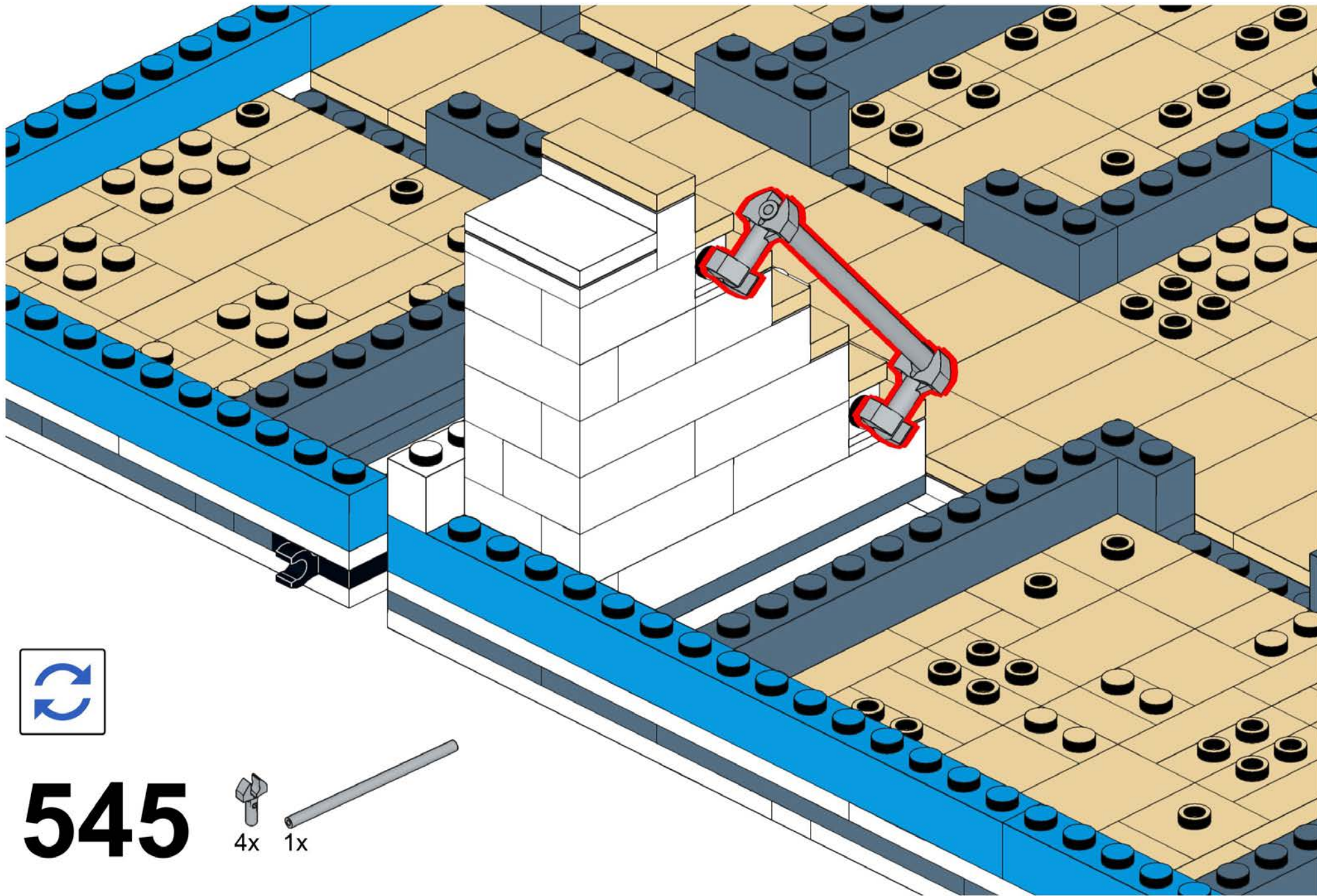

545



4x



1x

# 546

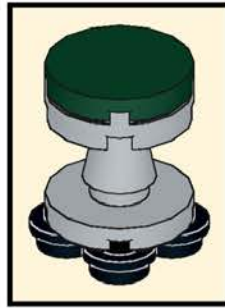
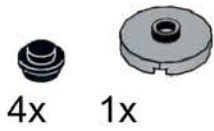

3x

# 547

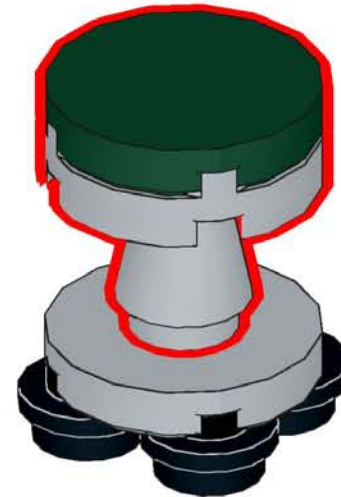



548

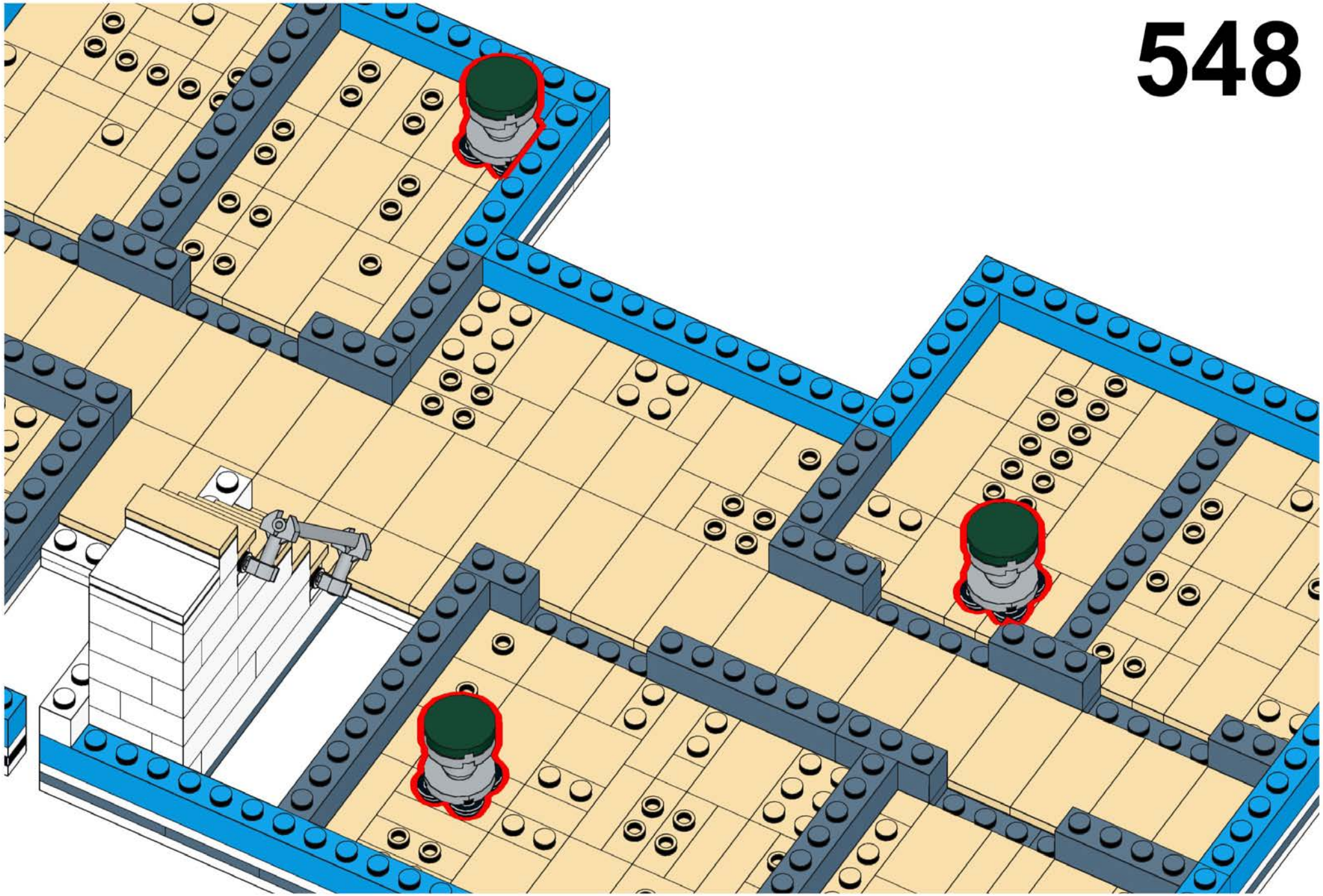

# 549

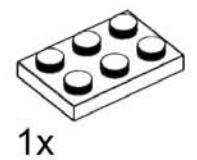
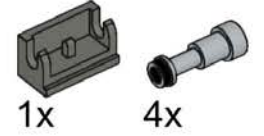
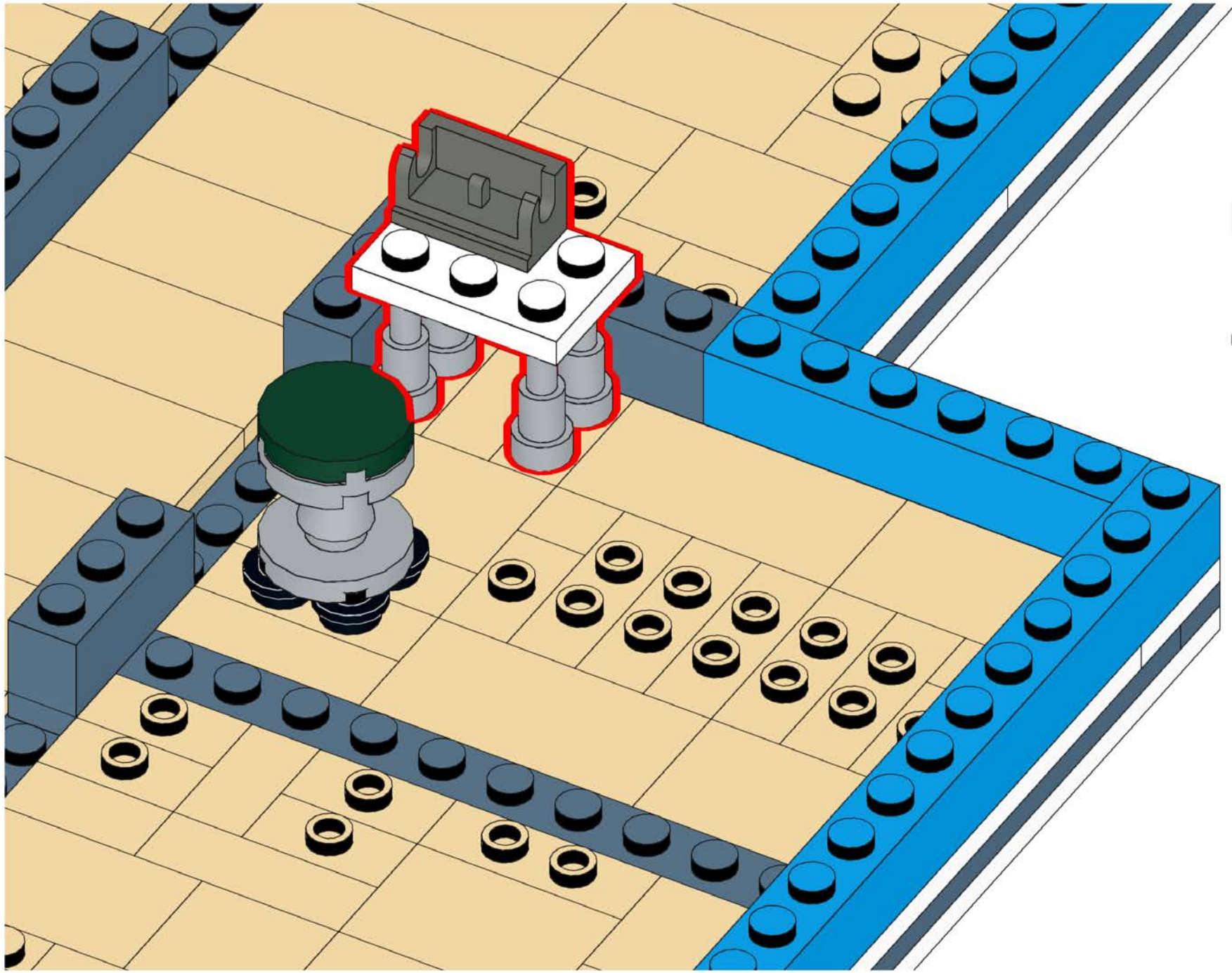

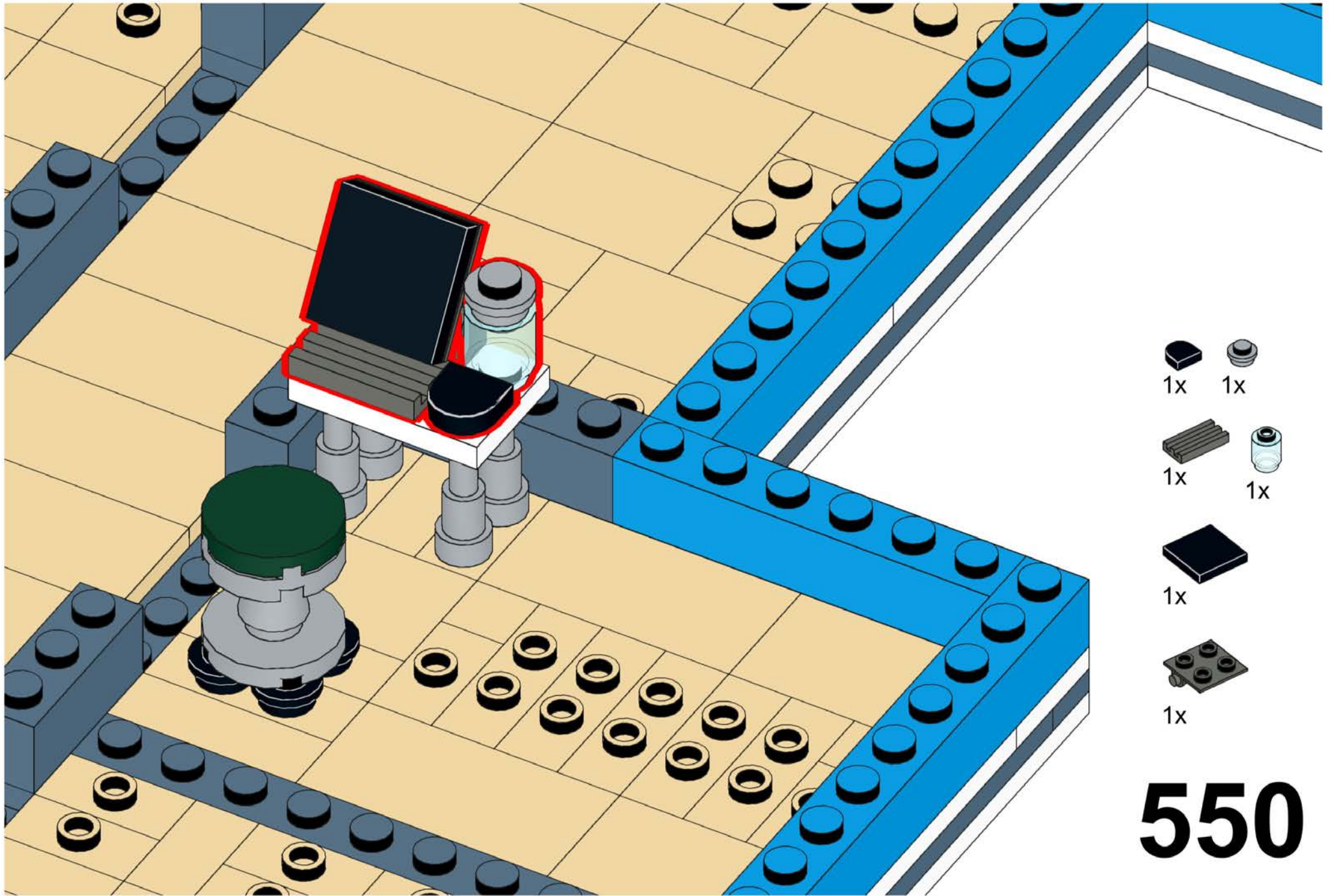

1x 1x

1x 1x





1x

1x

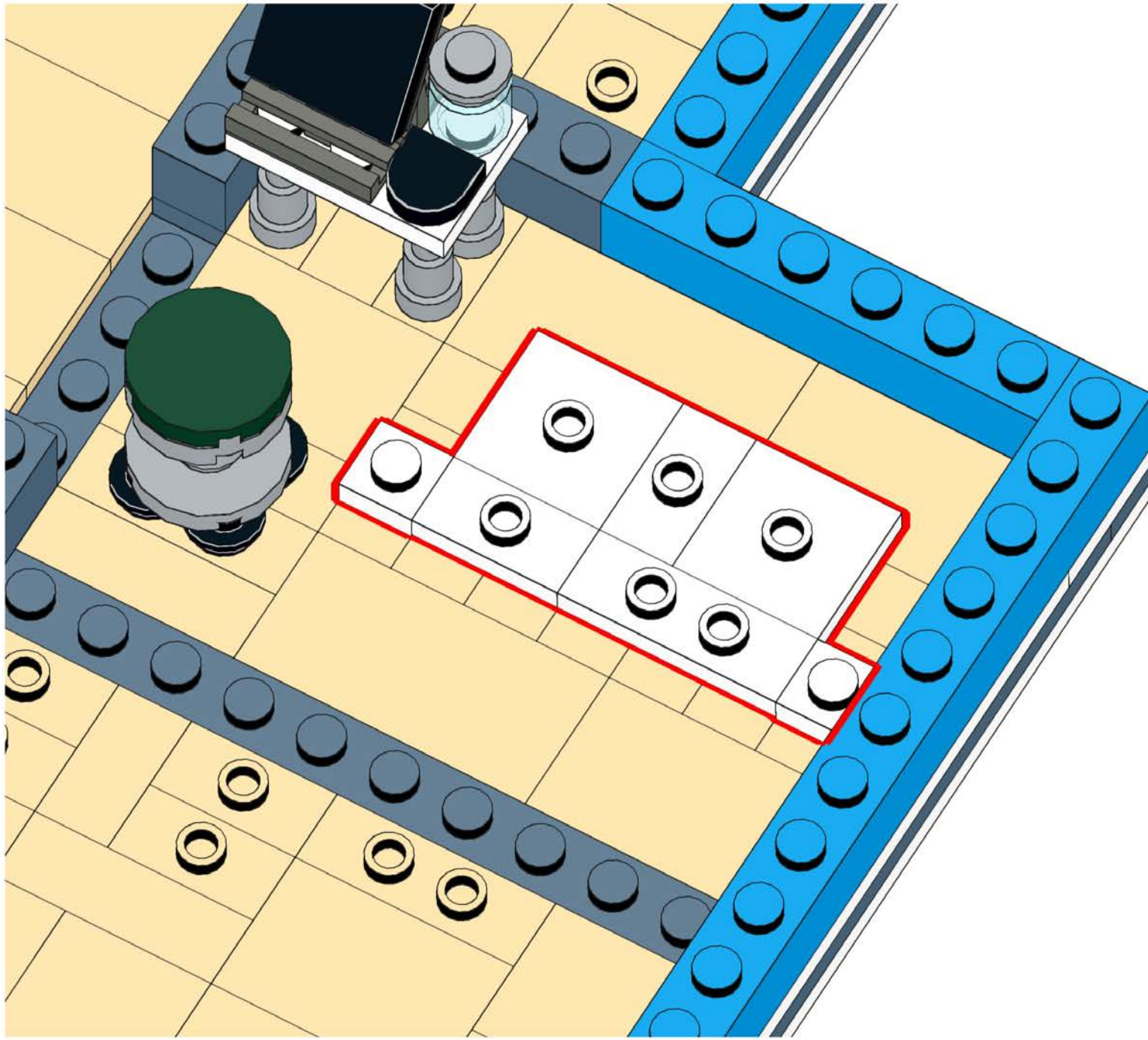
550

# 551



- 2x 
- 2x 
- 1x 
- 2x 

# 552

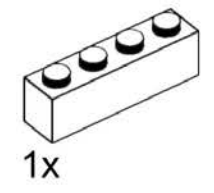
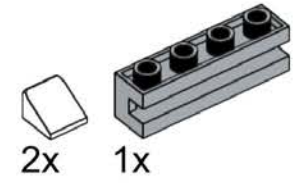
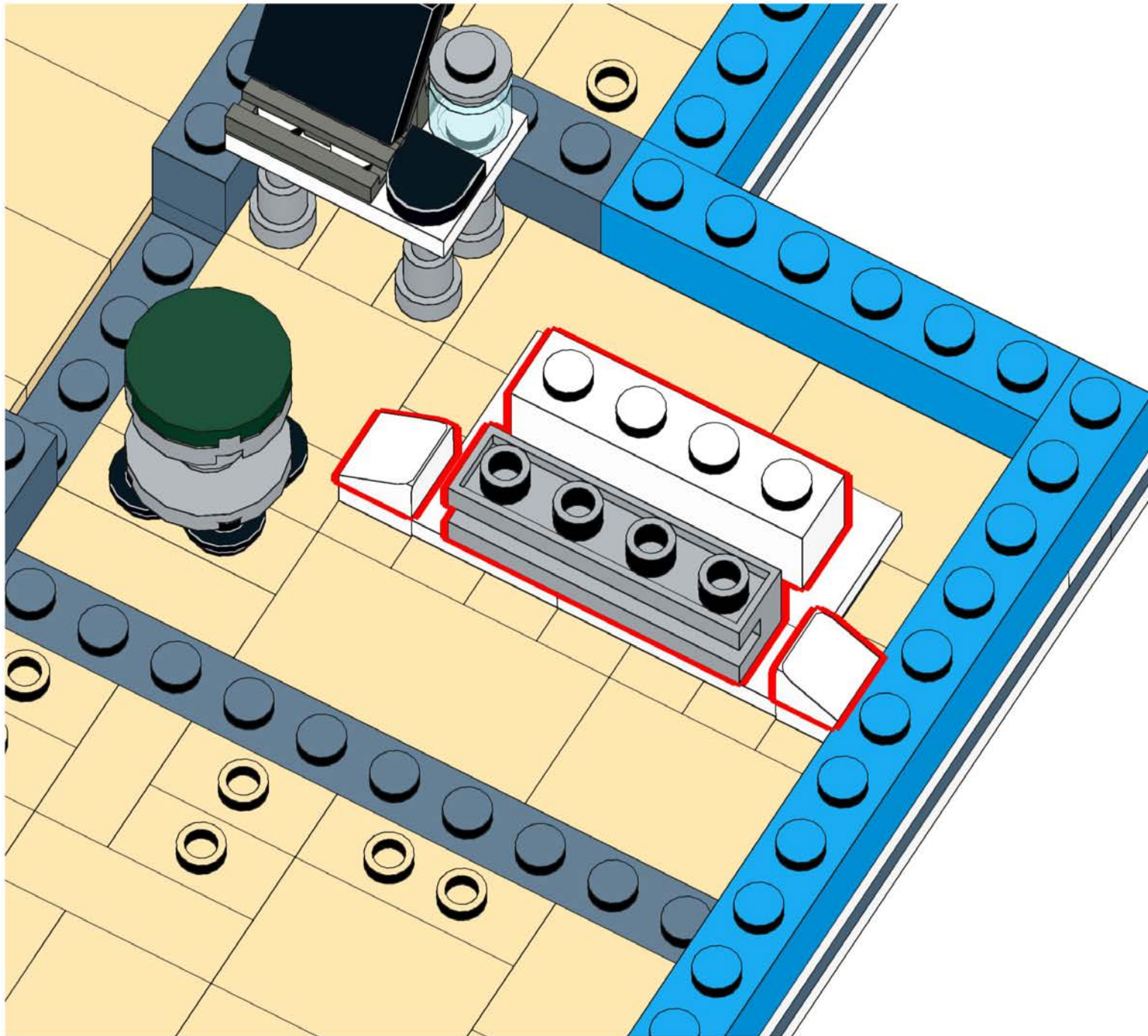

# 553

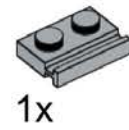
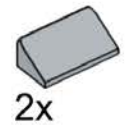
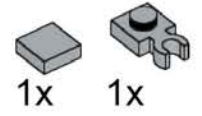
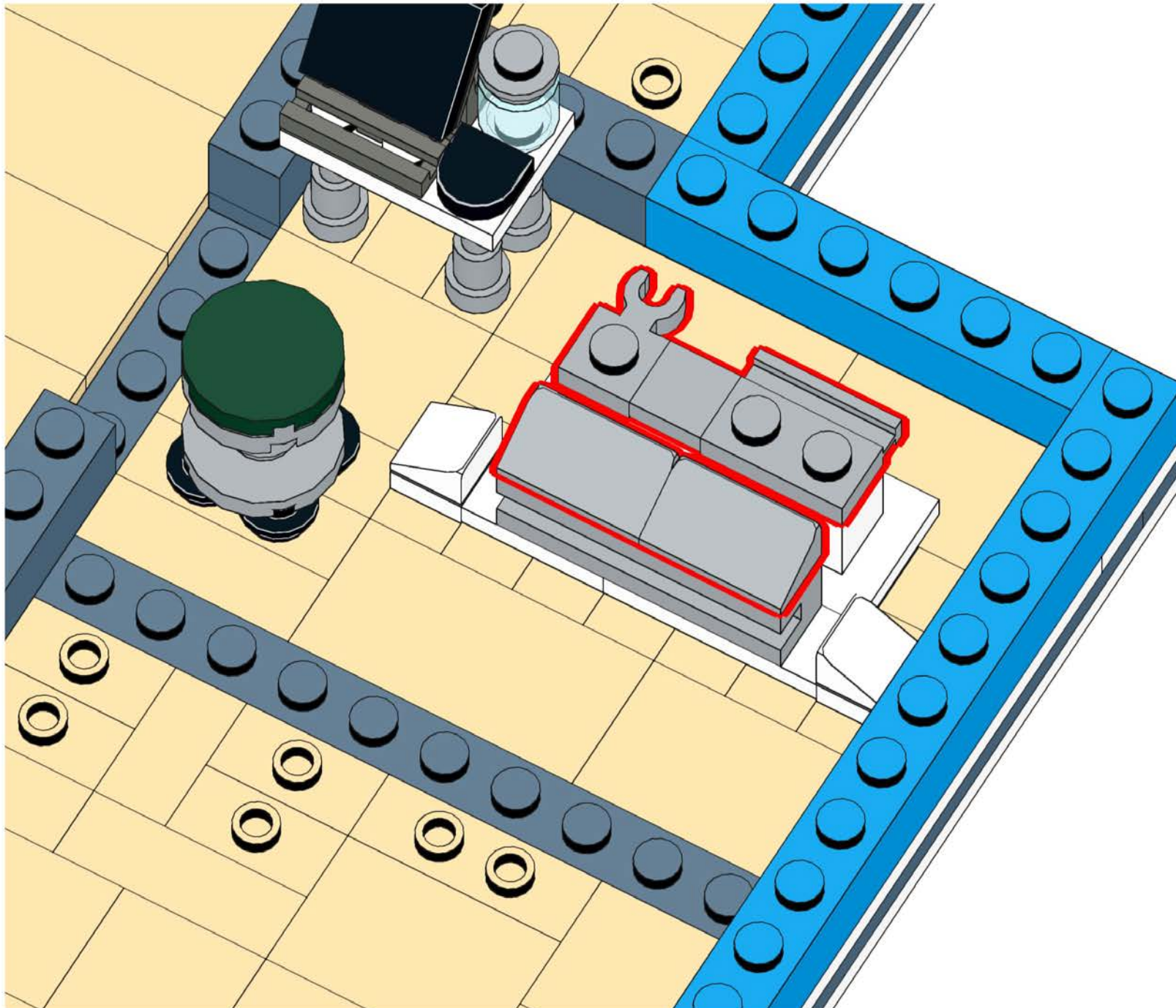

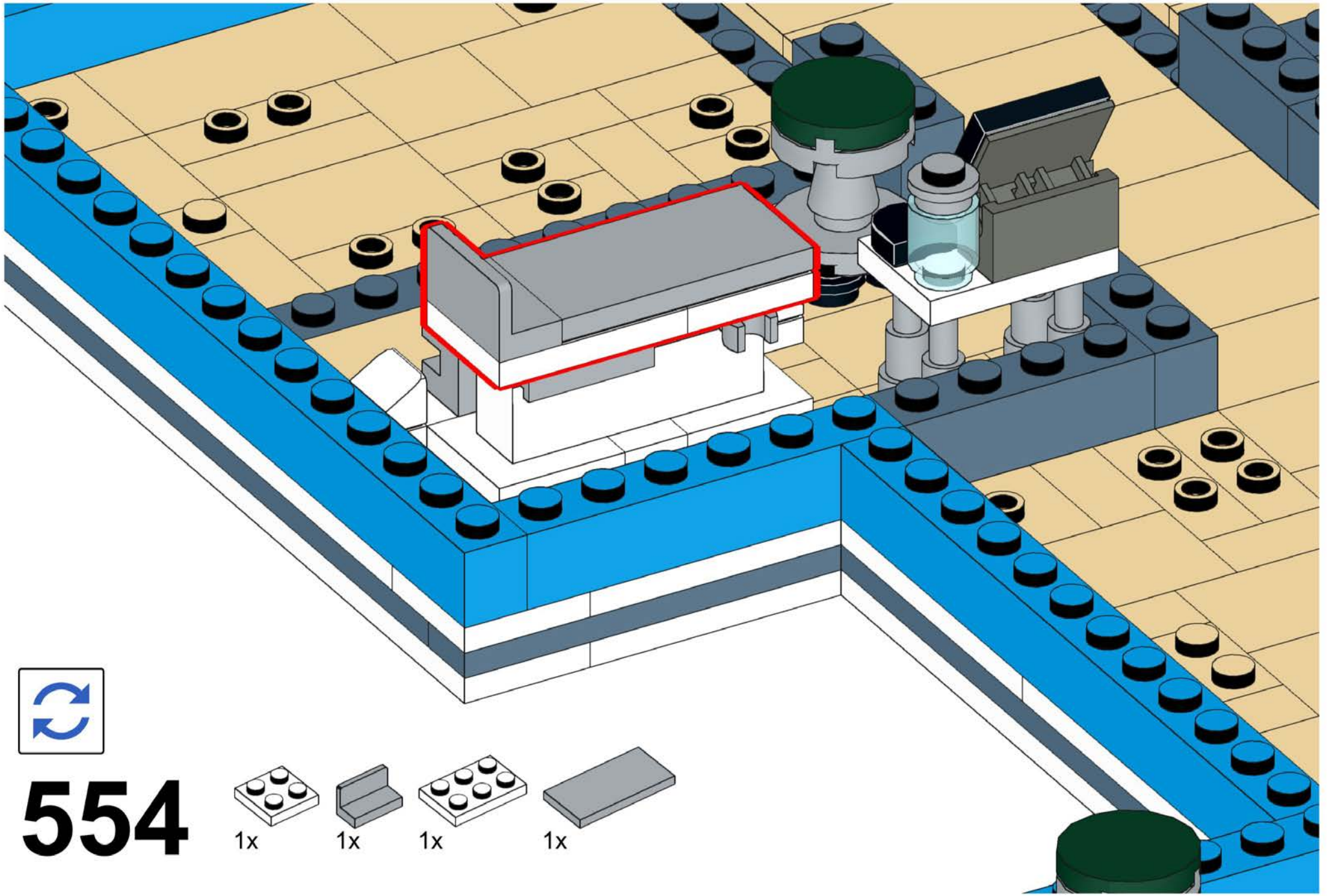

**554**

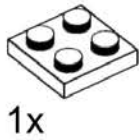

1x



1x

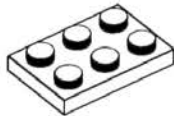

1x

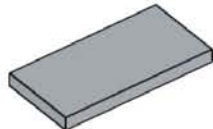

1x

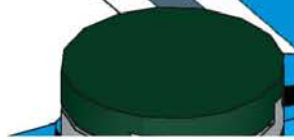

# 555

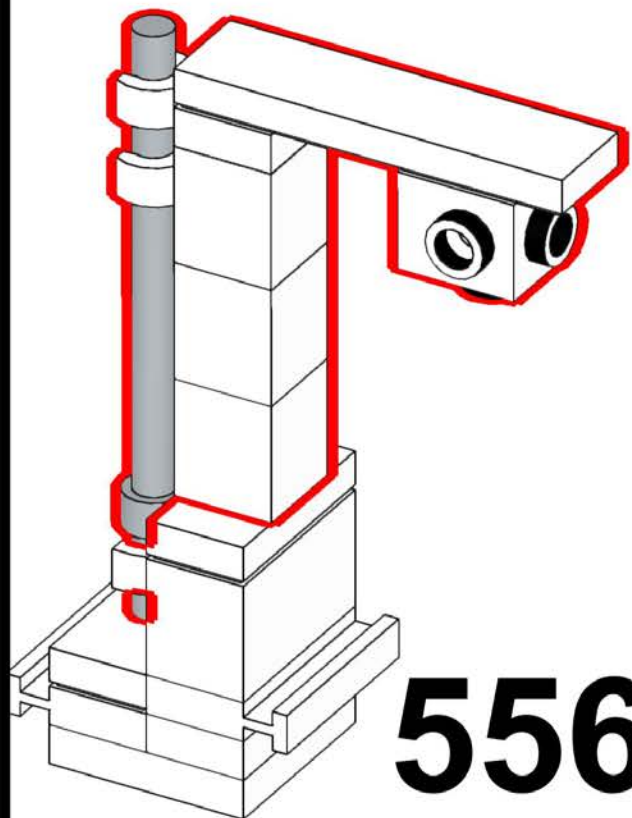
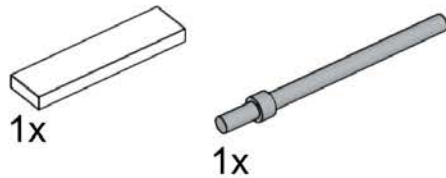
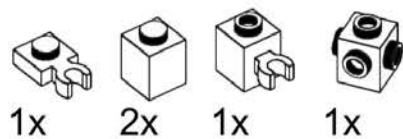
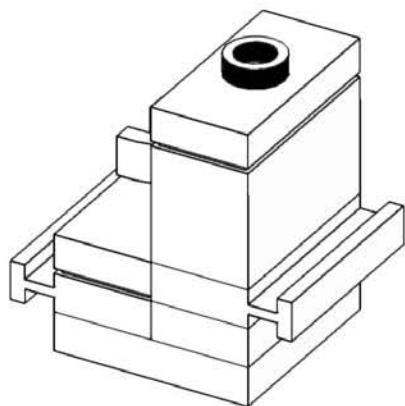
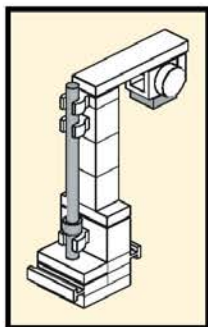
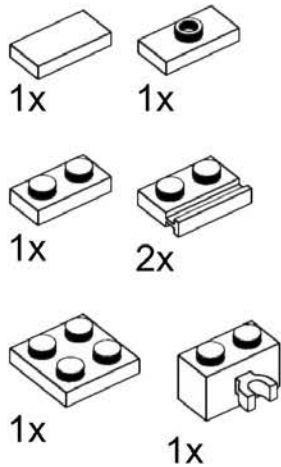

# 556

# 557

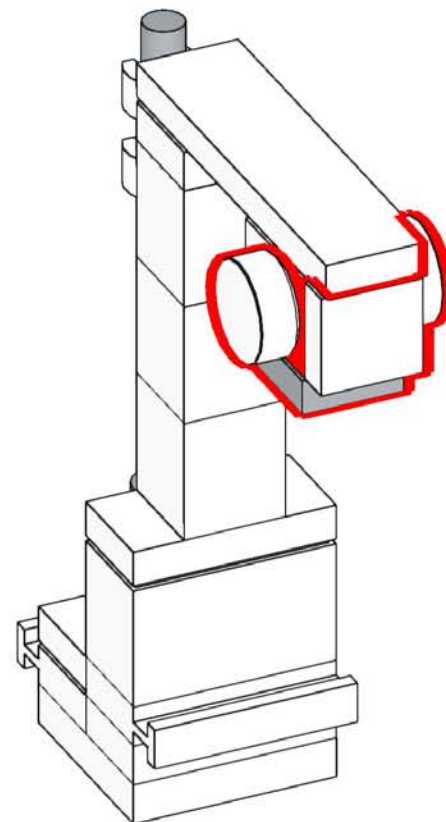
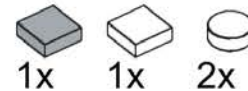



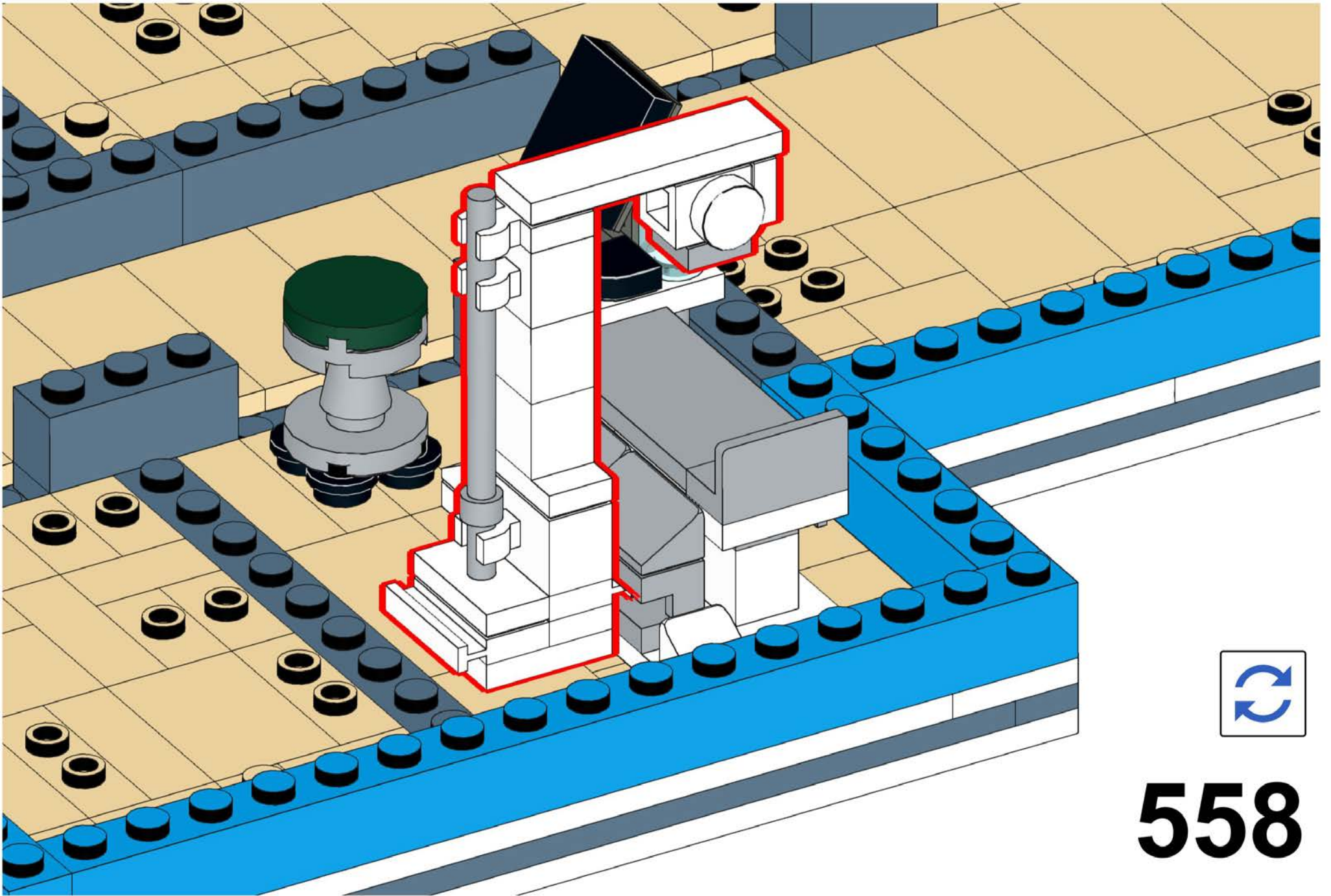

**558**

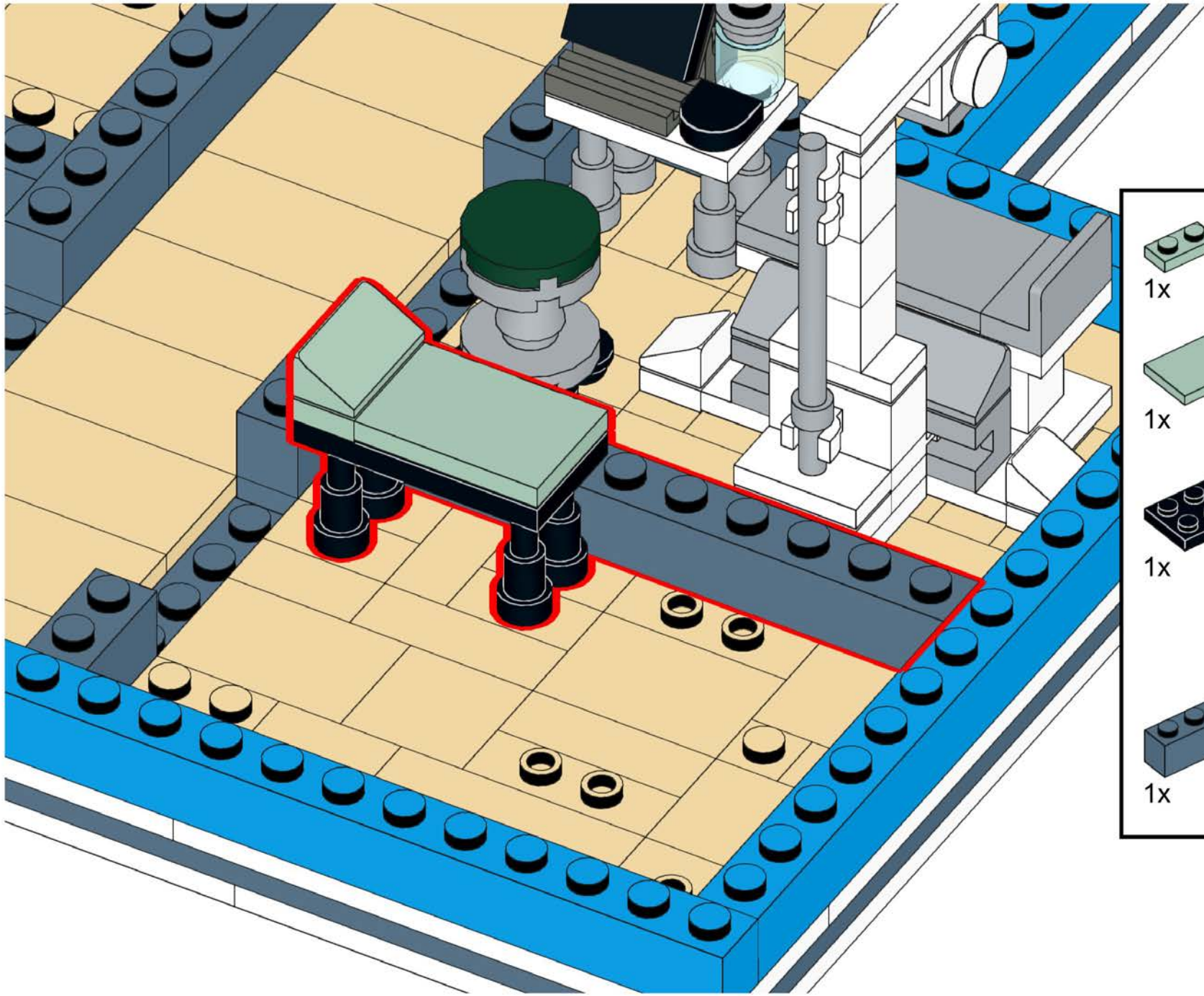

1x 1x

1x 4x

1x

1x

**559**

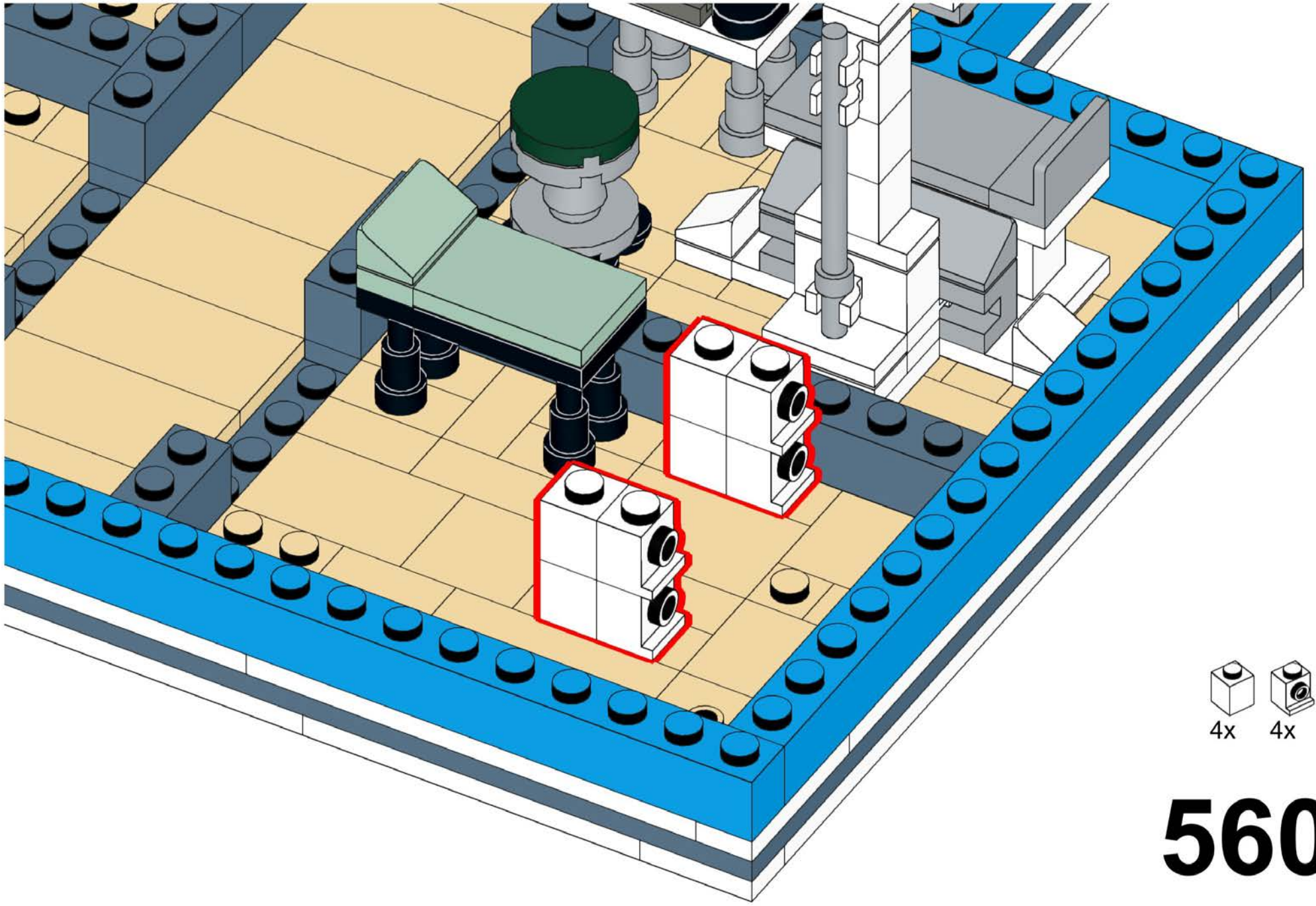

4x 4x



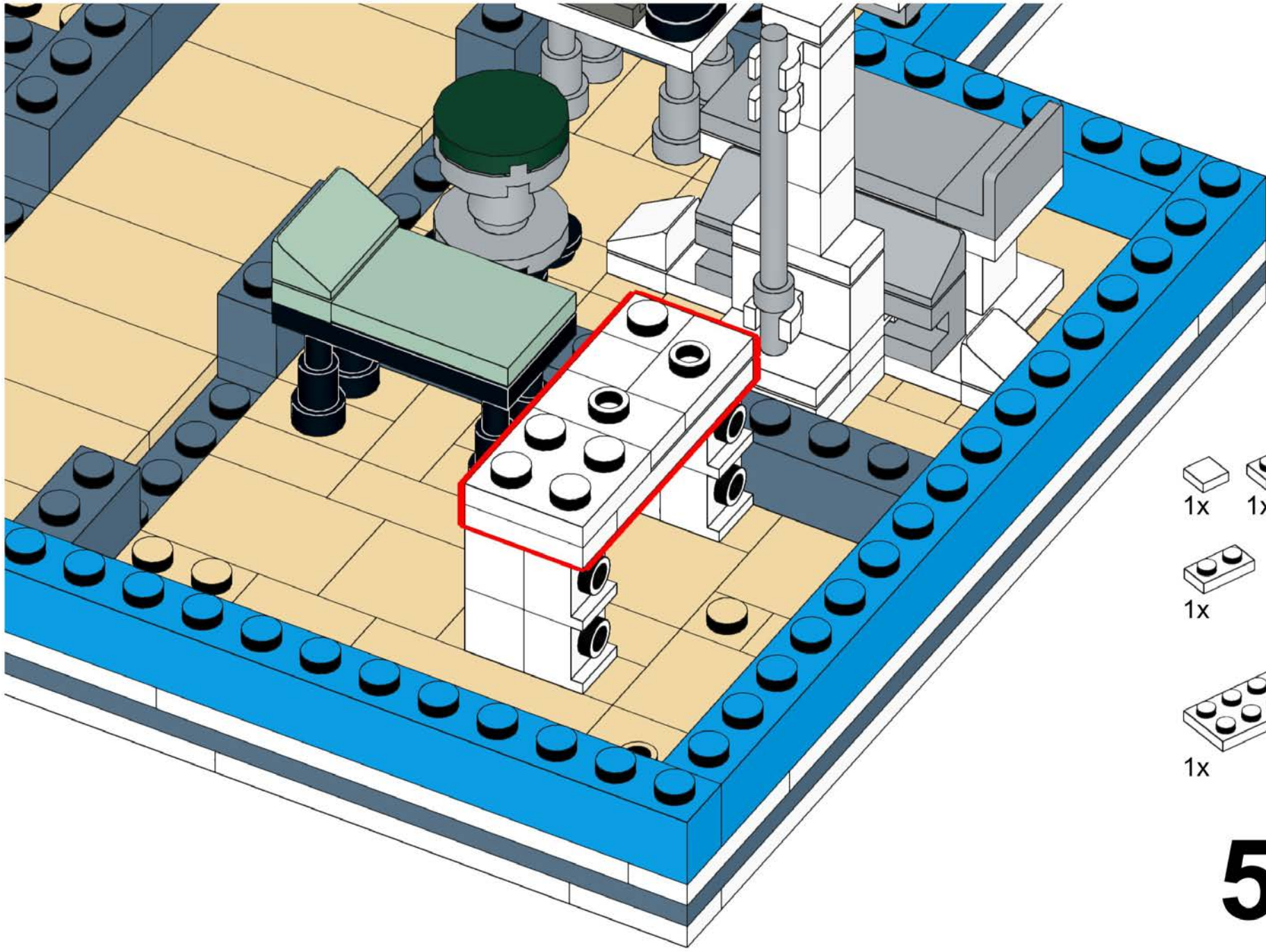

560

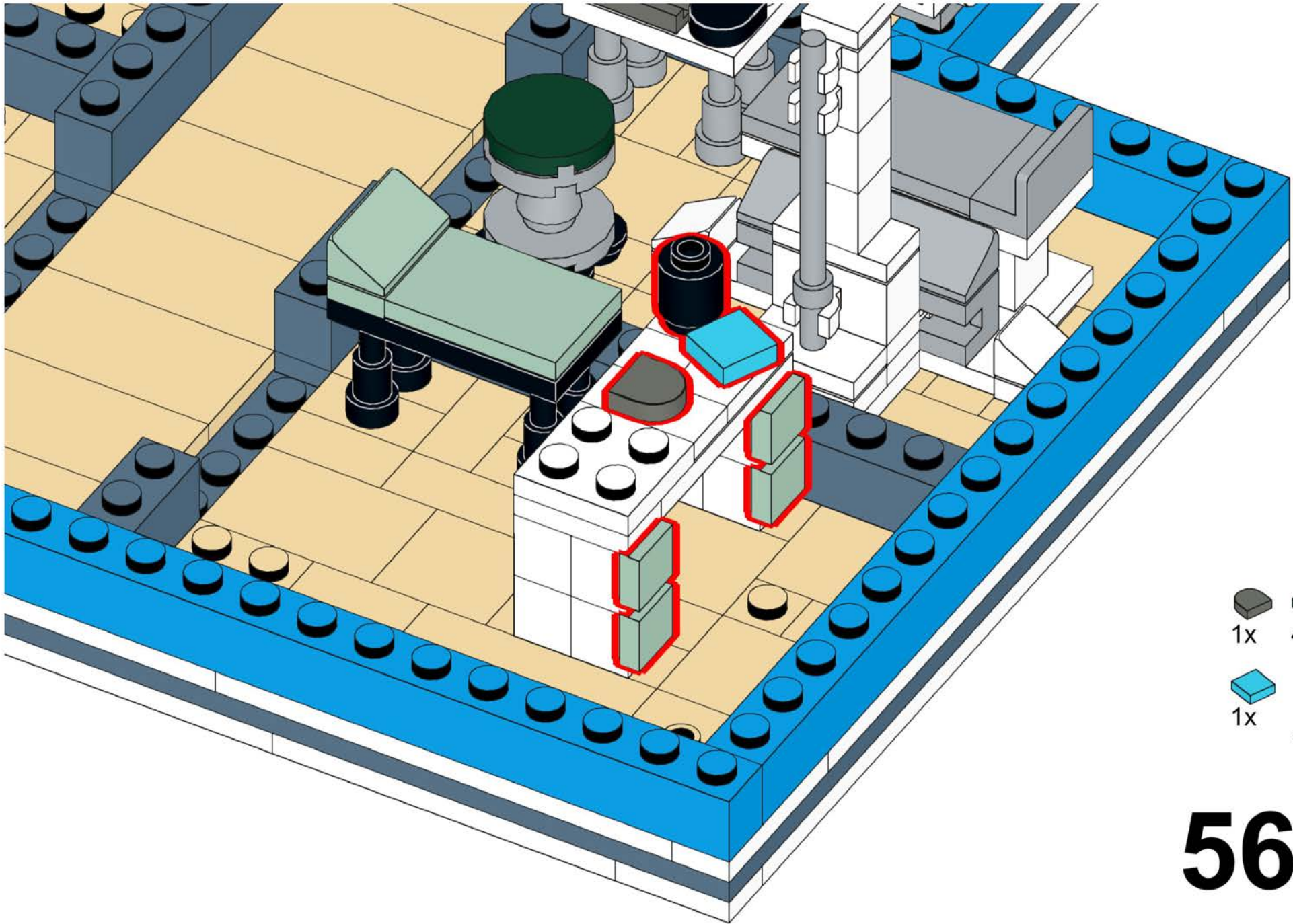

- 1x 1x 2x
- 1x 1x
- 1x

561



- 1x 
- 4x 
- 1x 
- 1x 



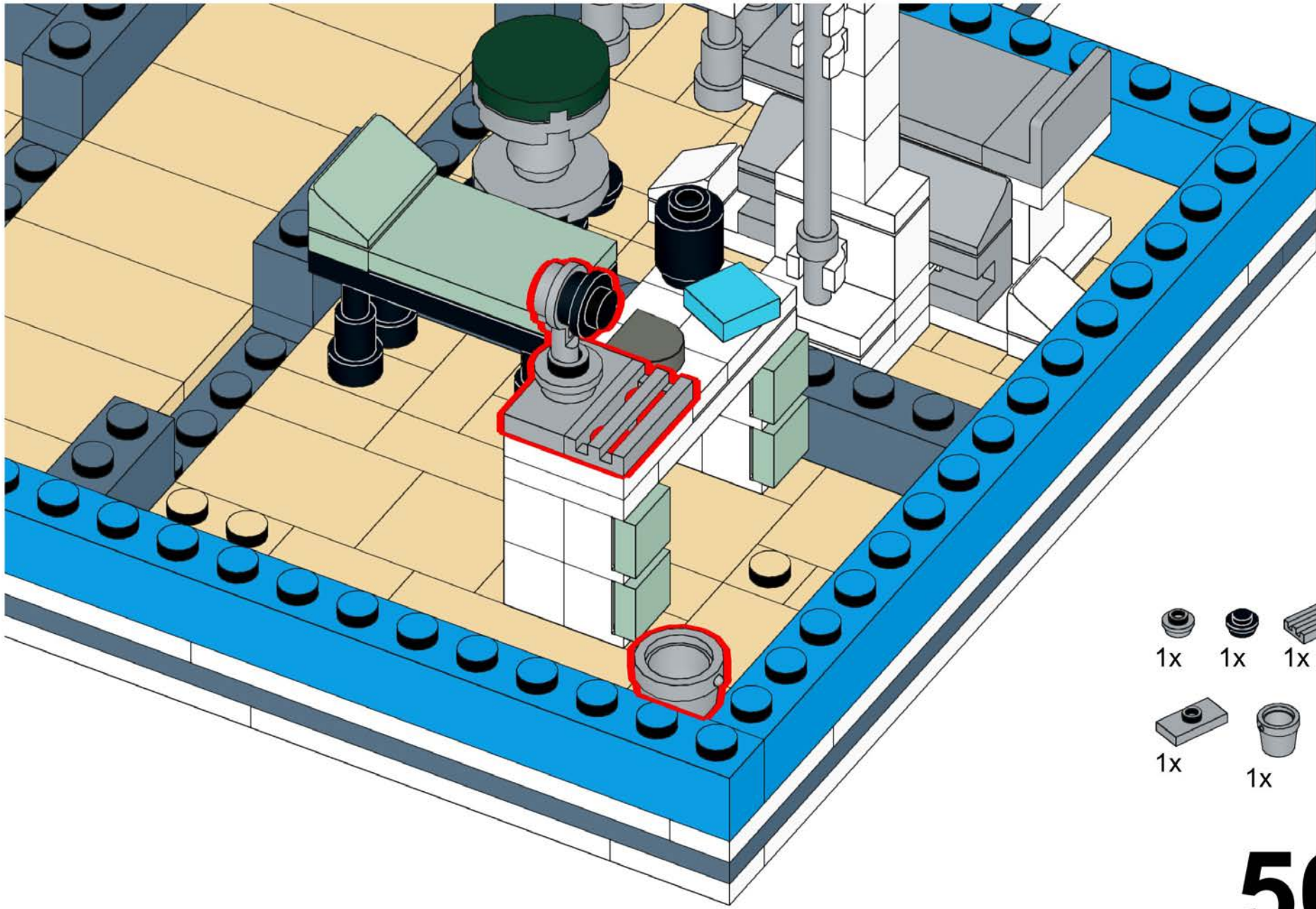

**562**

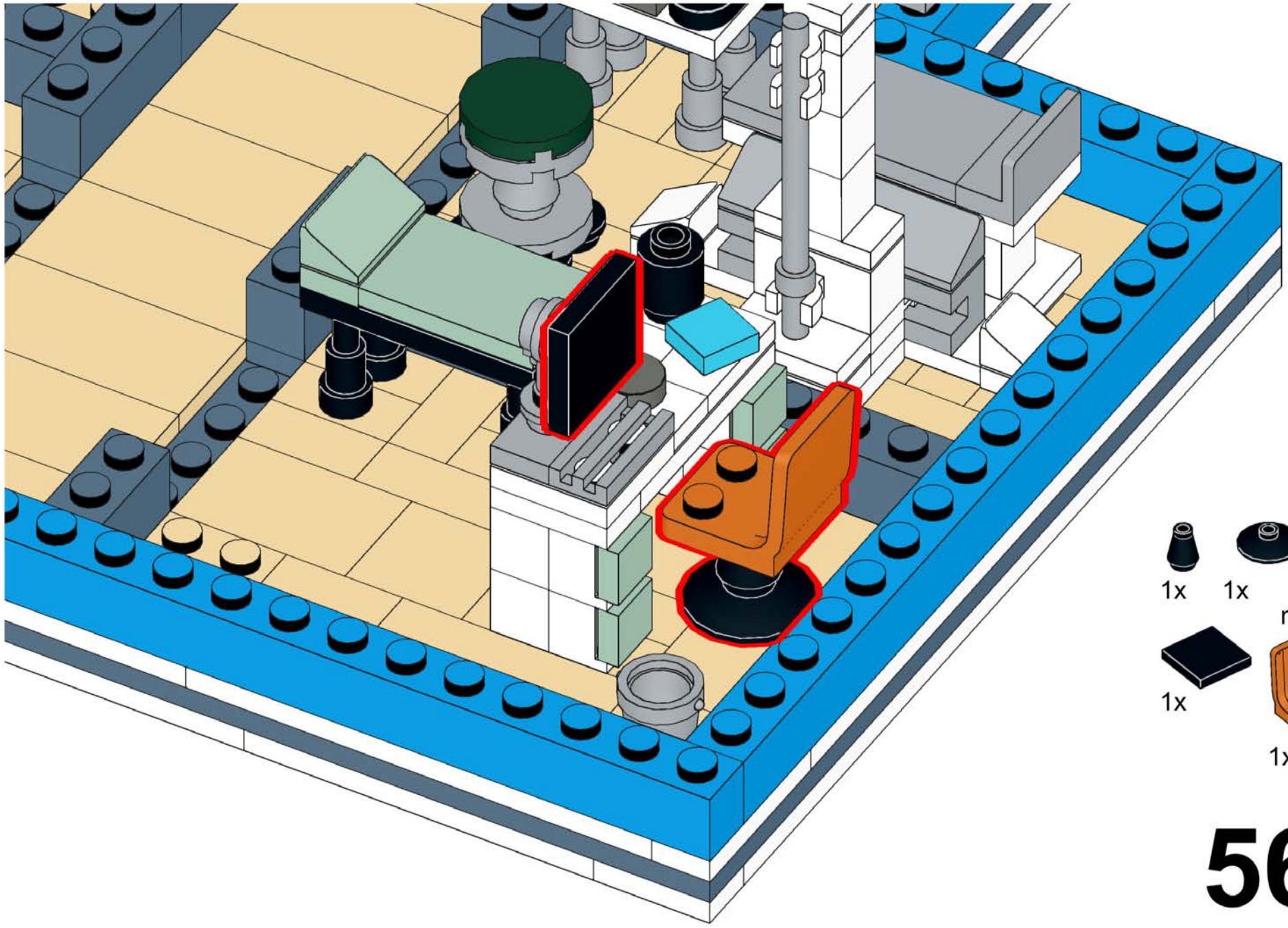

- 1x
- 1x
- 1x
- 1x
- 1x
- 1x

**563**



- 1x 
- 1x 
- 1x 
- 1x 
- 1x *mdf*

**564**

# 565

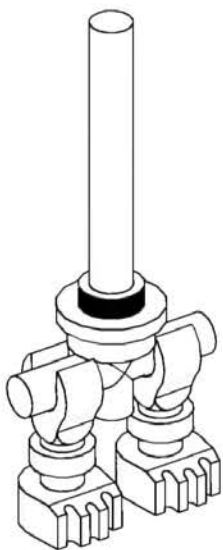
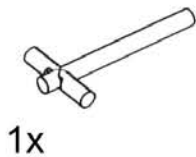
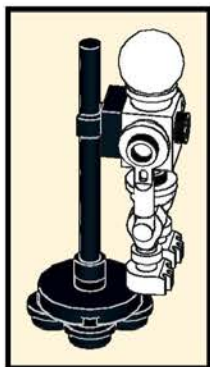

# 566

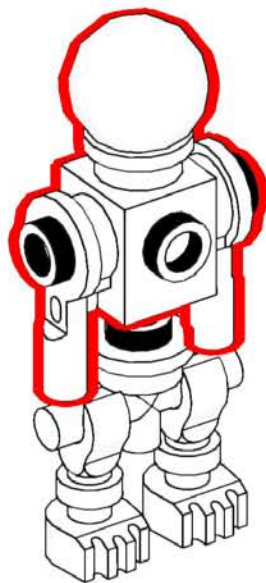
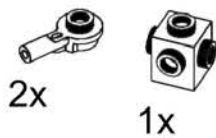
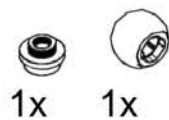

# 567

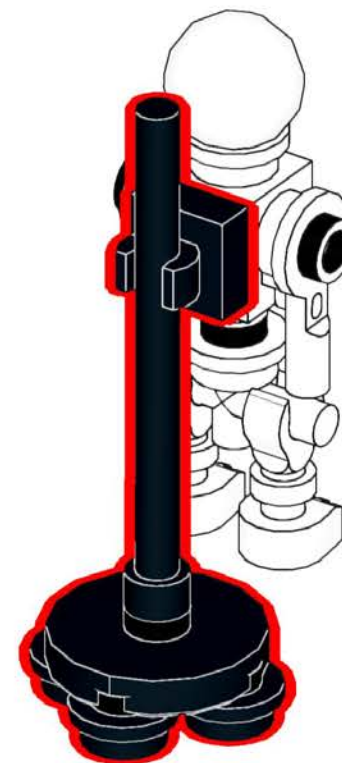



# 568

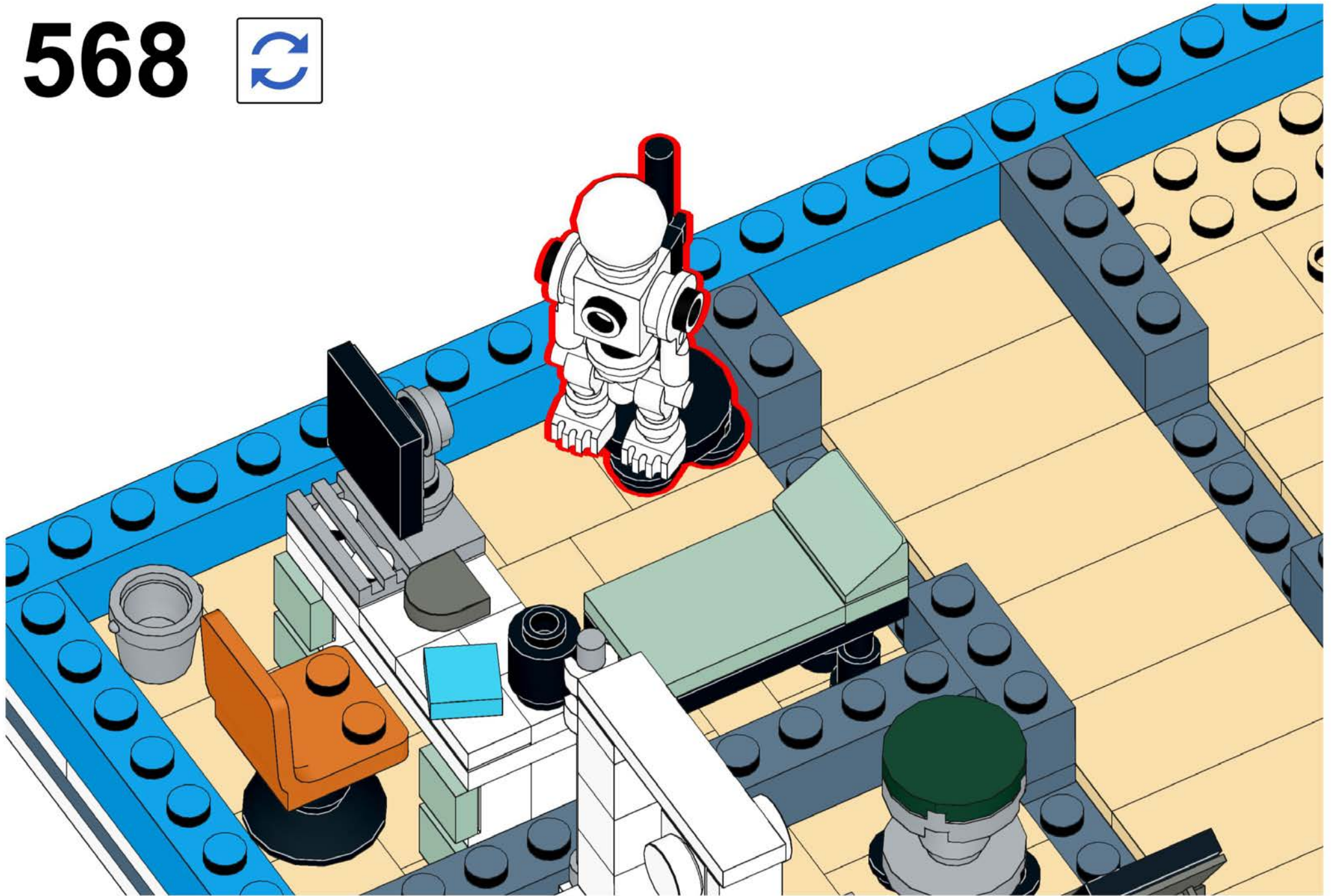

# 569

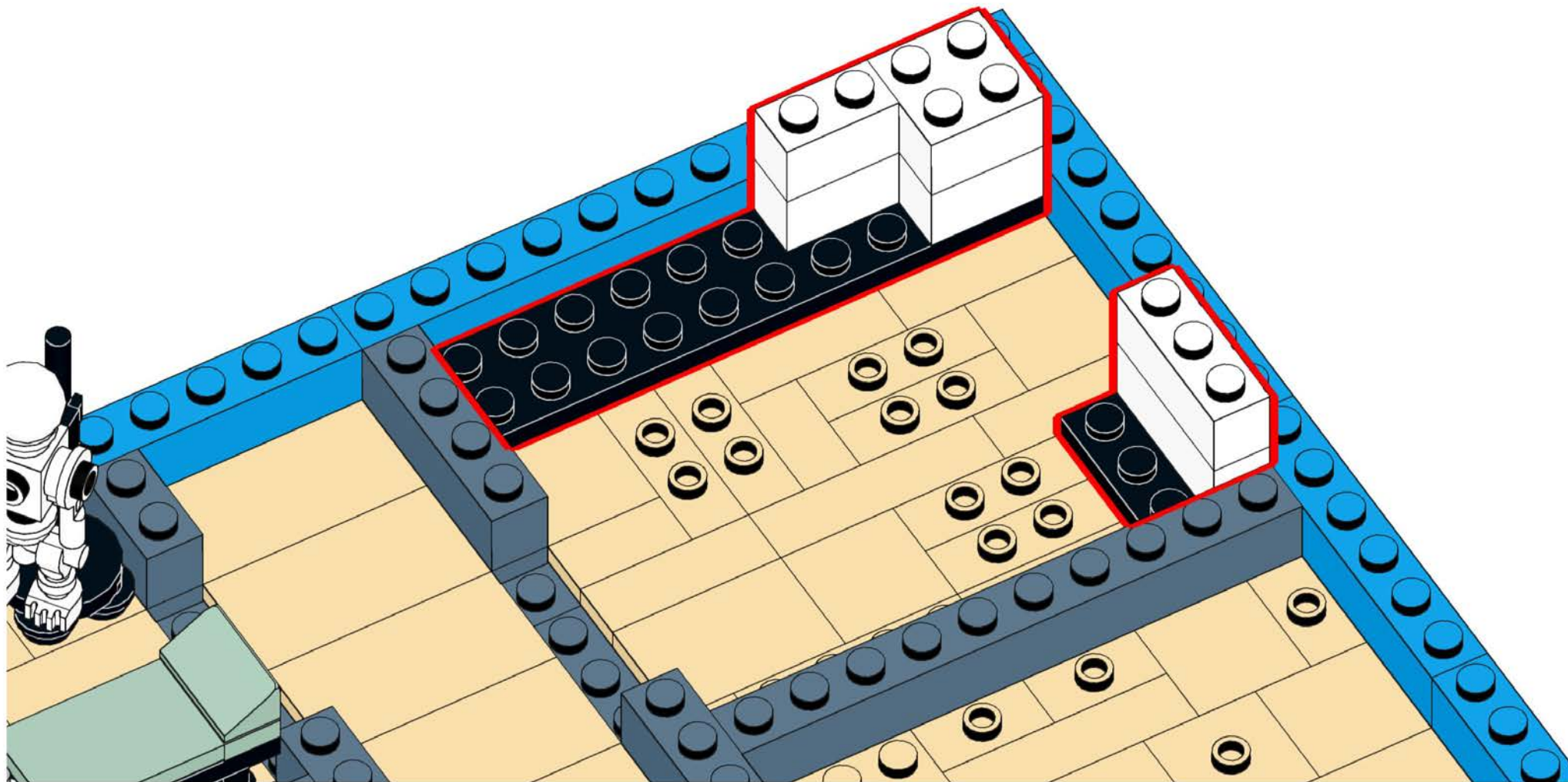
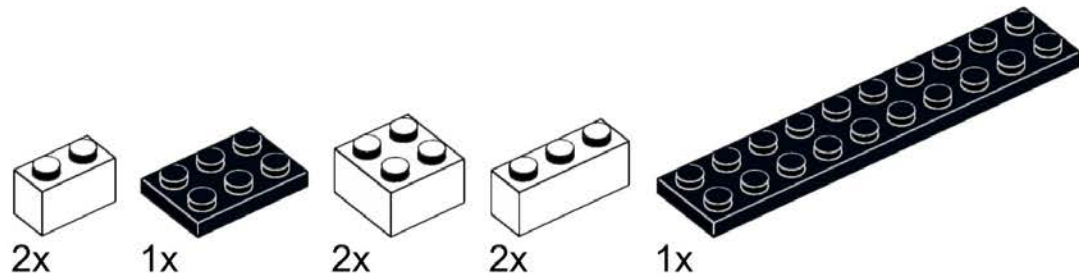

# 570

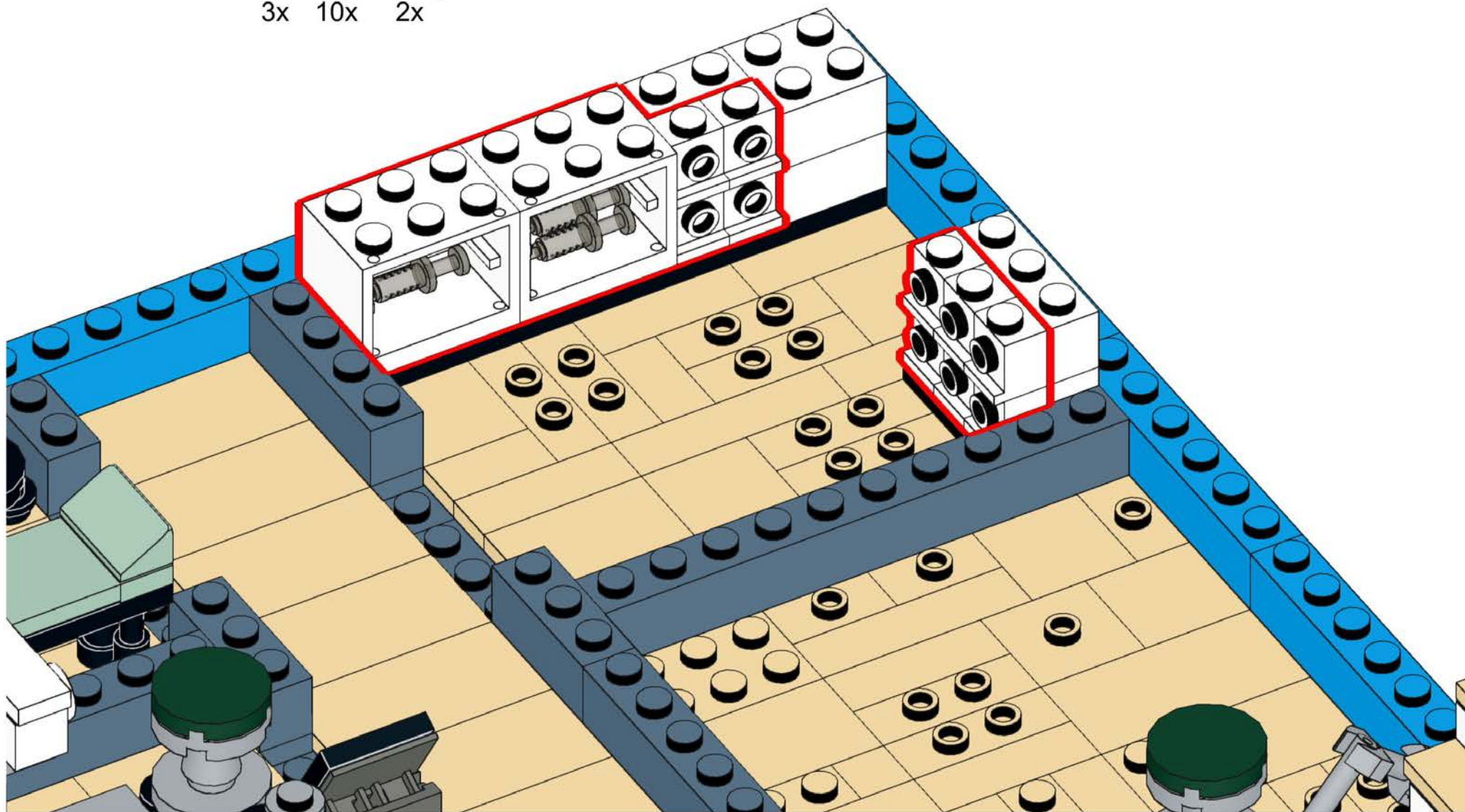
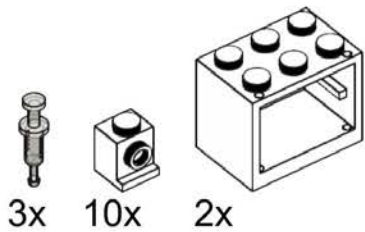

# 571

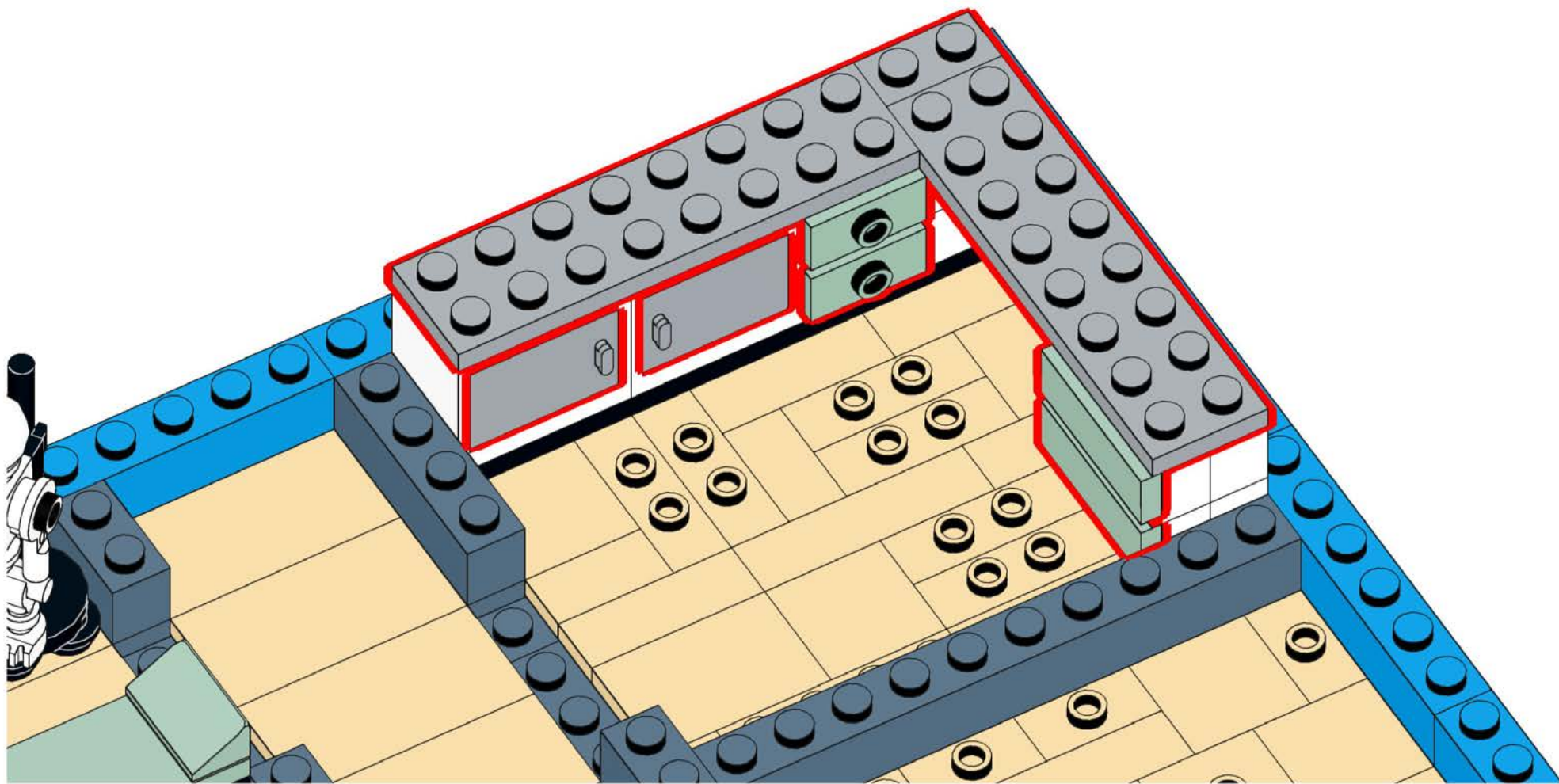
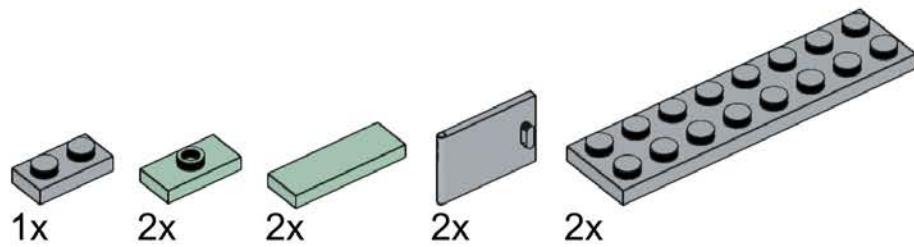

# 572

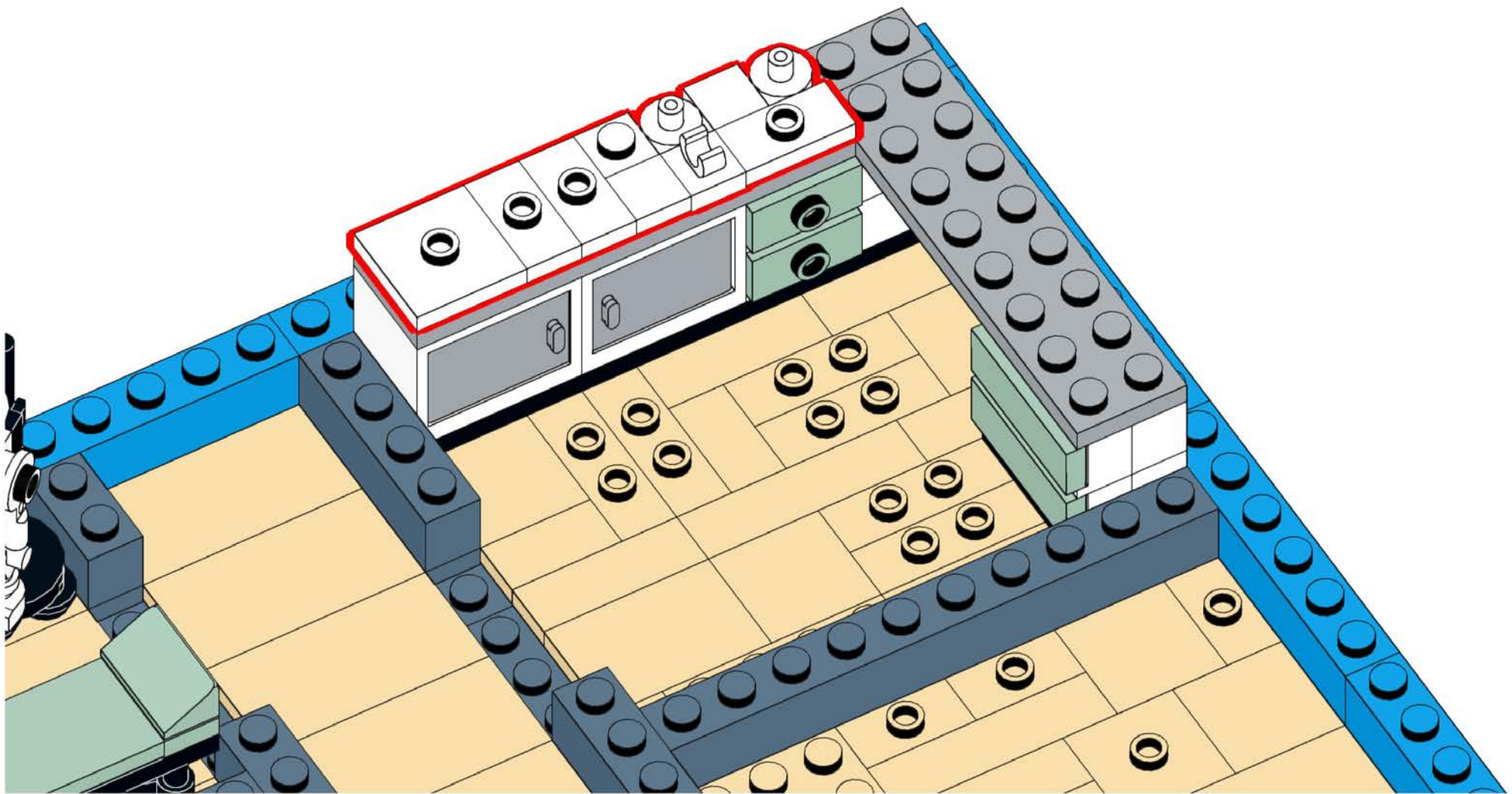
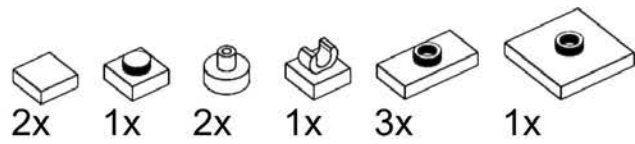

# 573

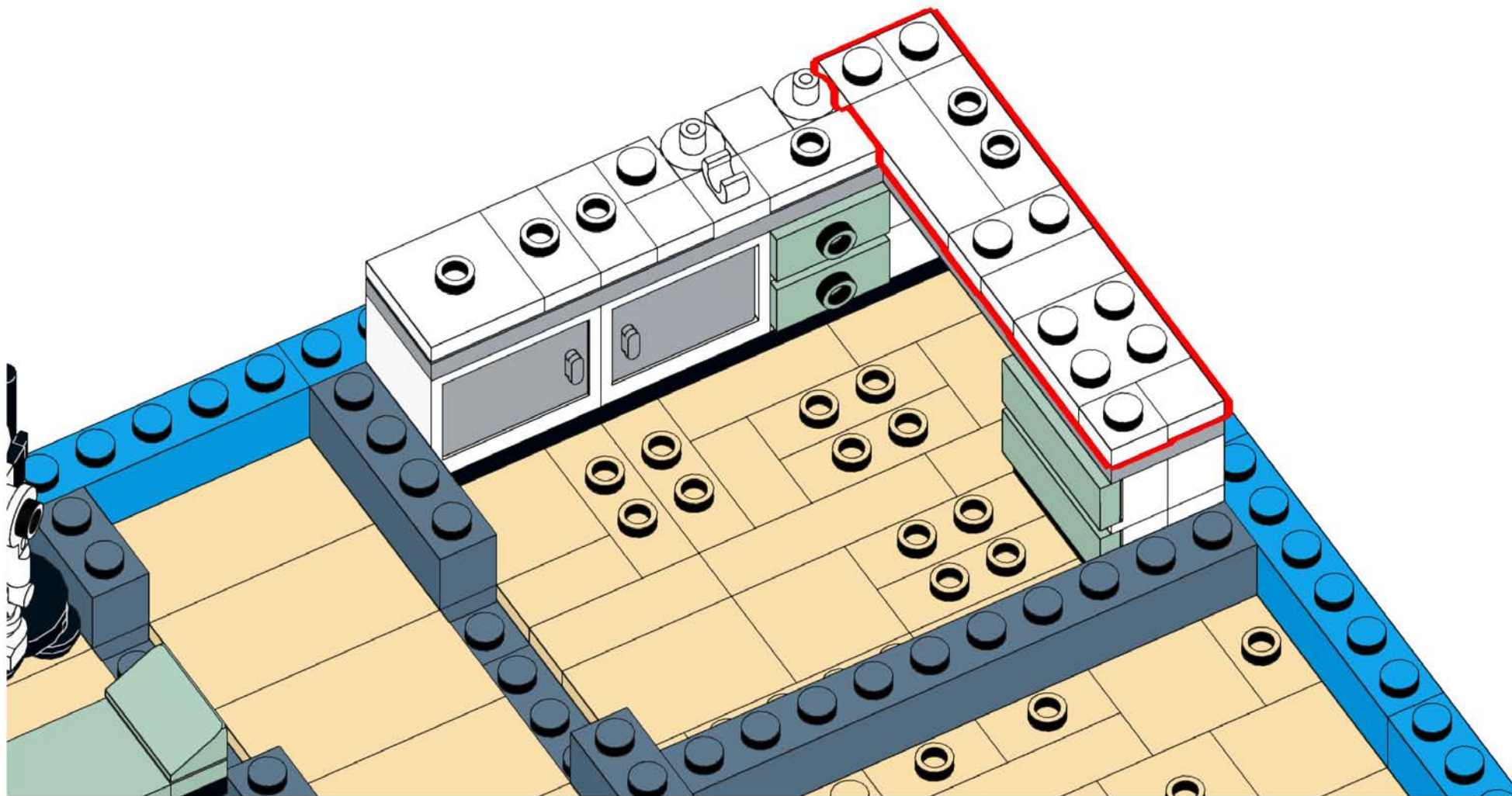
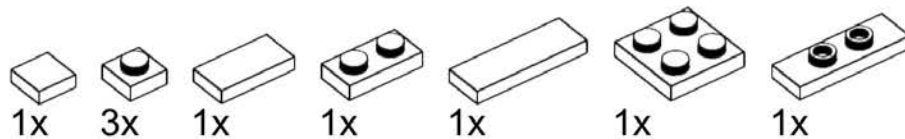

# 574

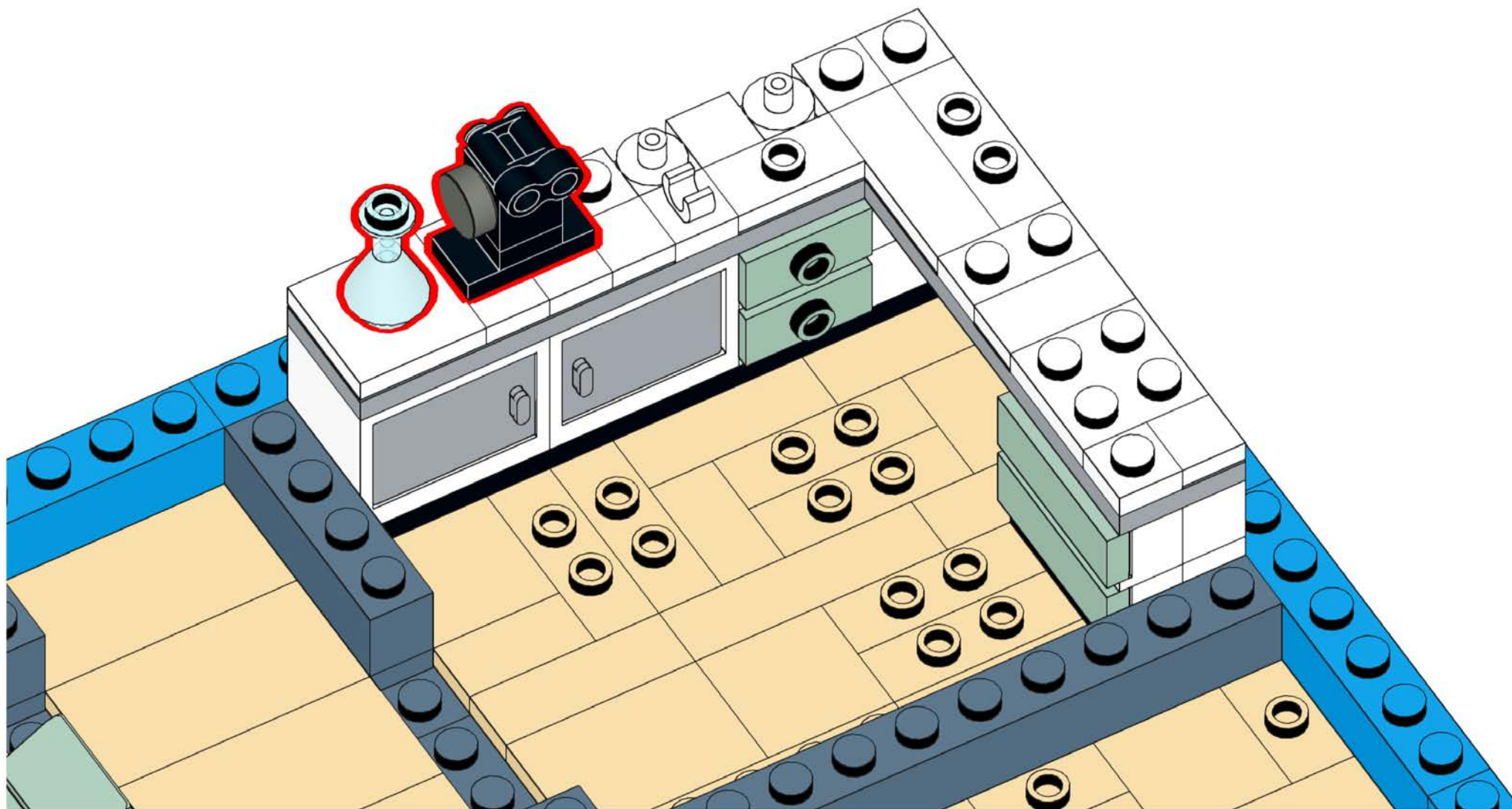
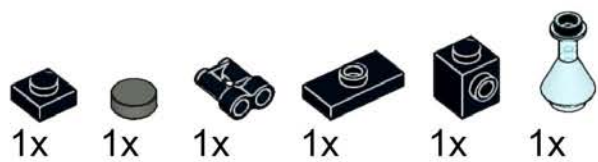

# 575

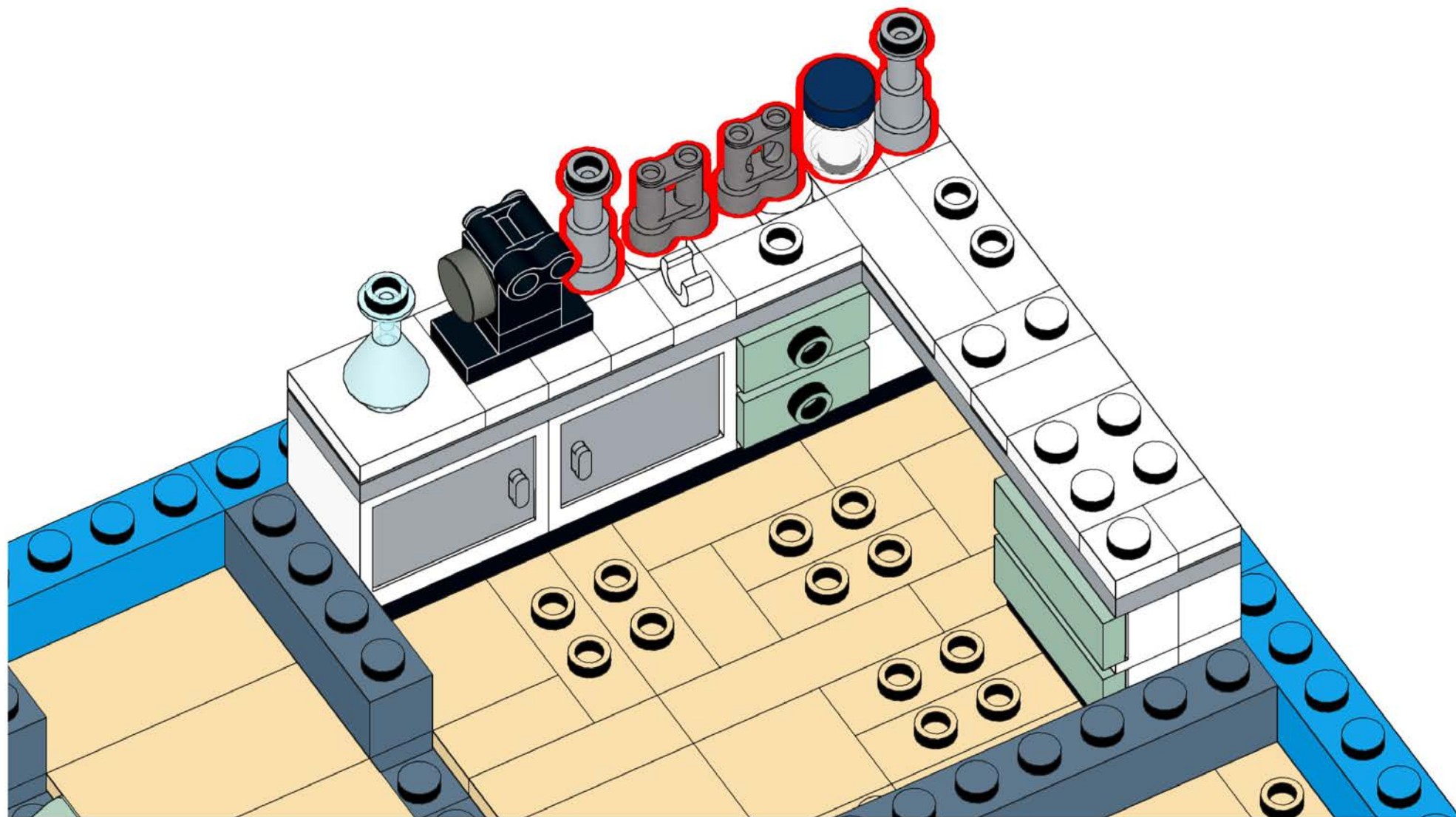



# 576



1x



1x



1x



1x



2x

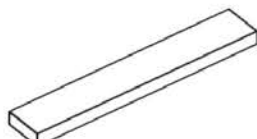

1x

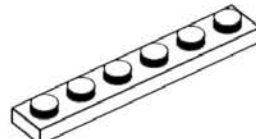

1x

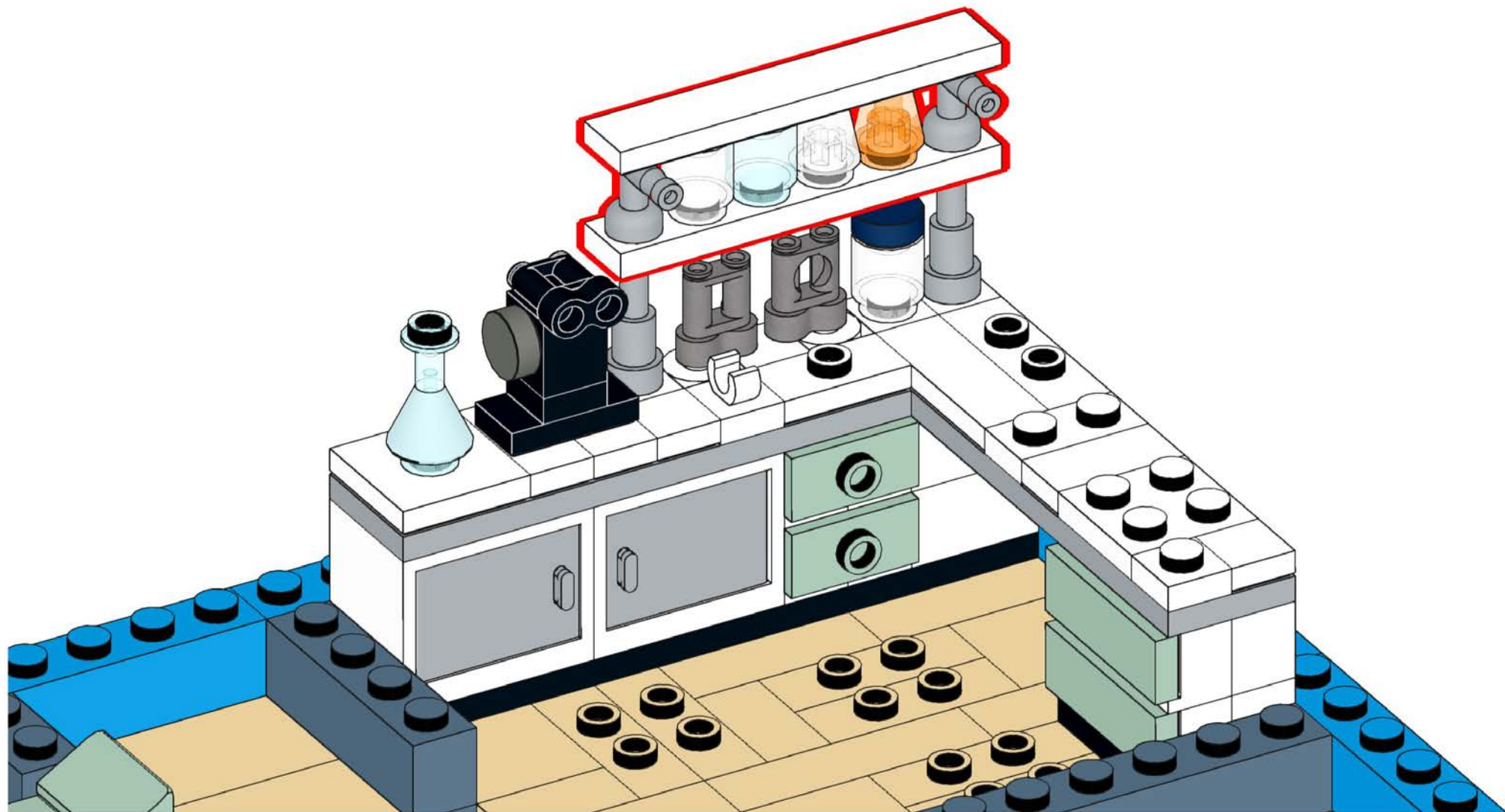

# 577

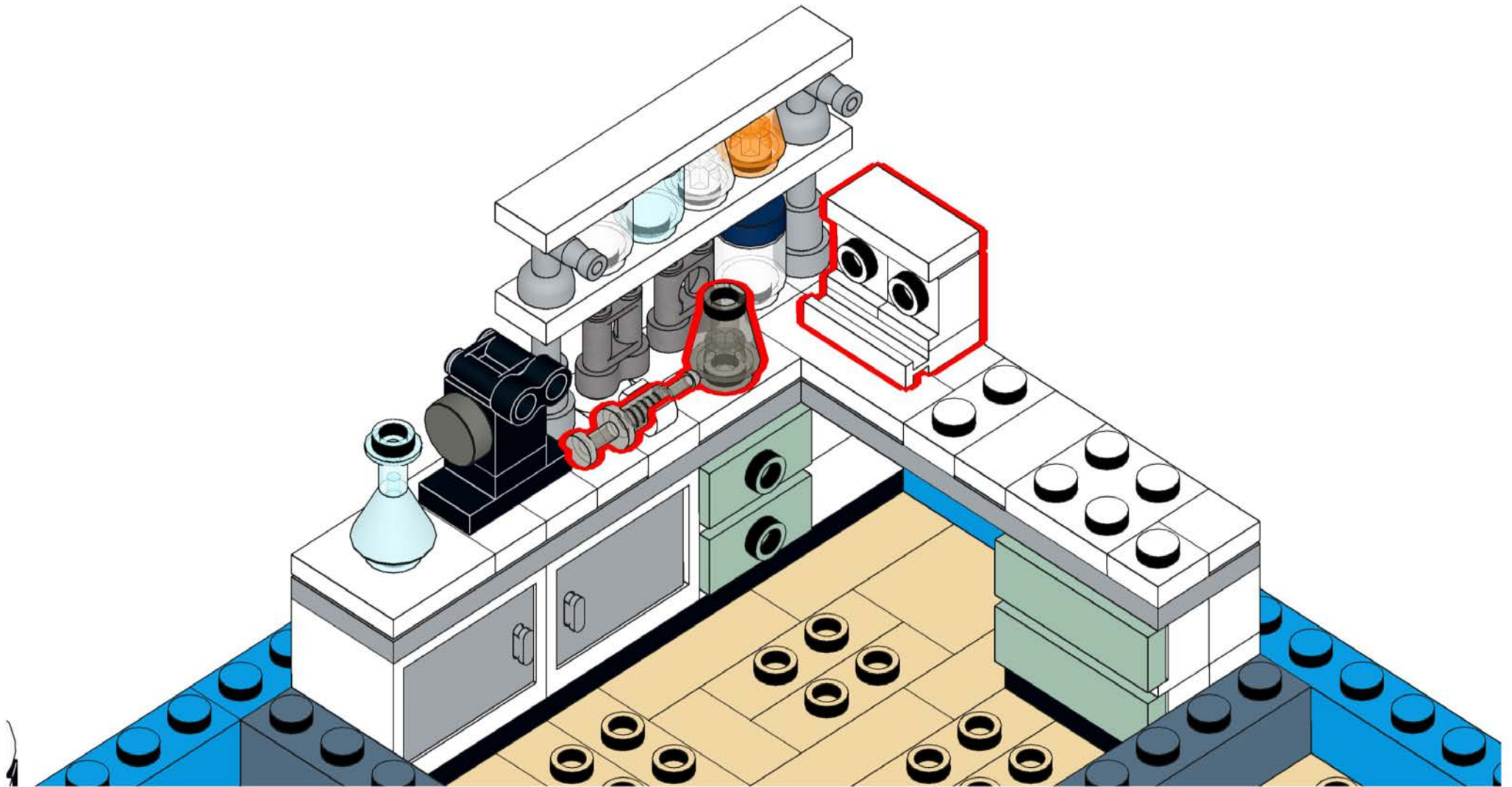
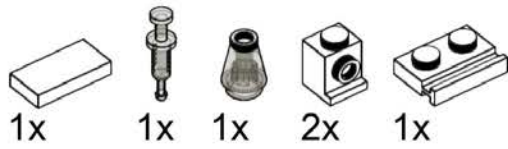

# 578

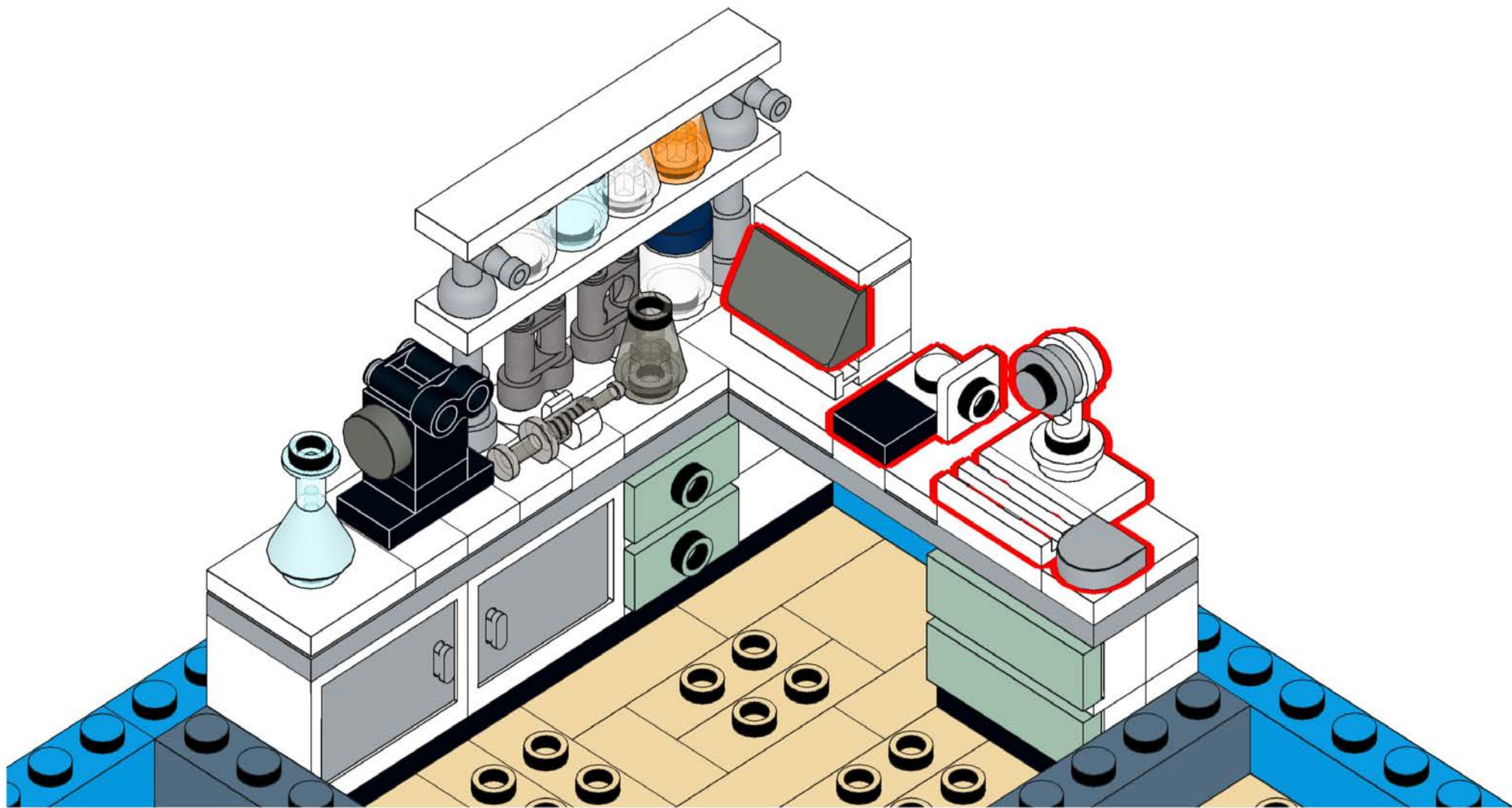
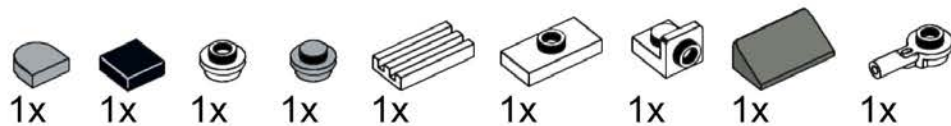

# 579

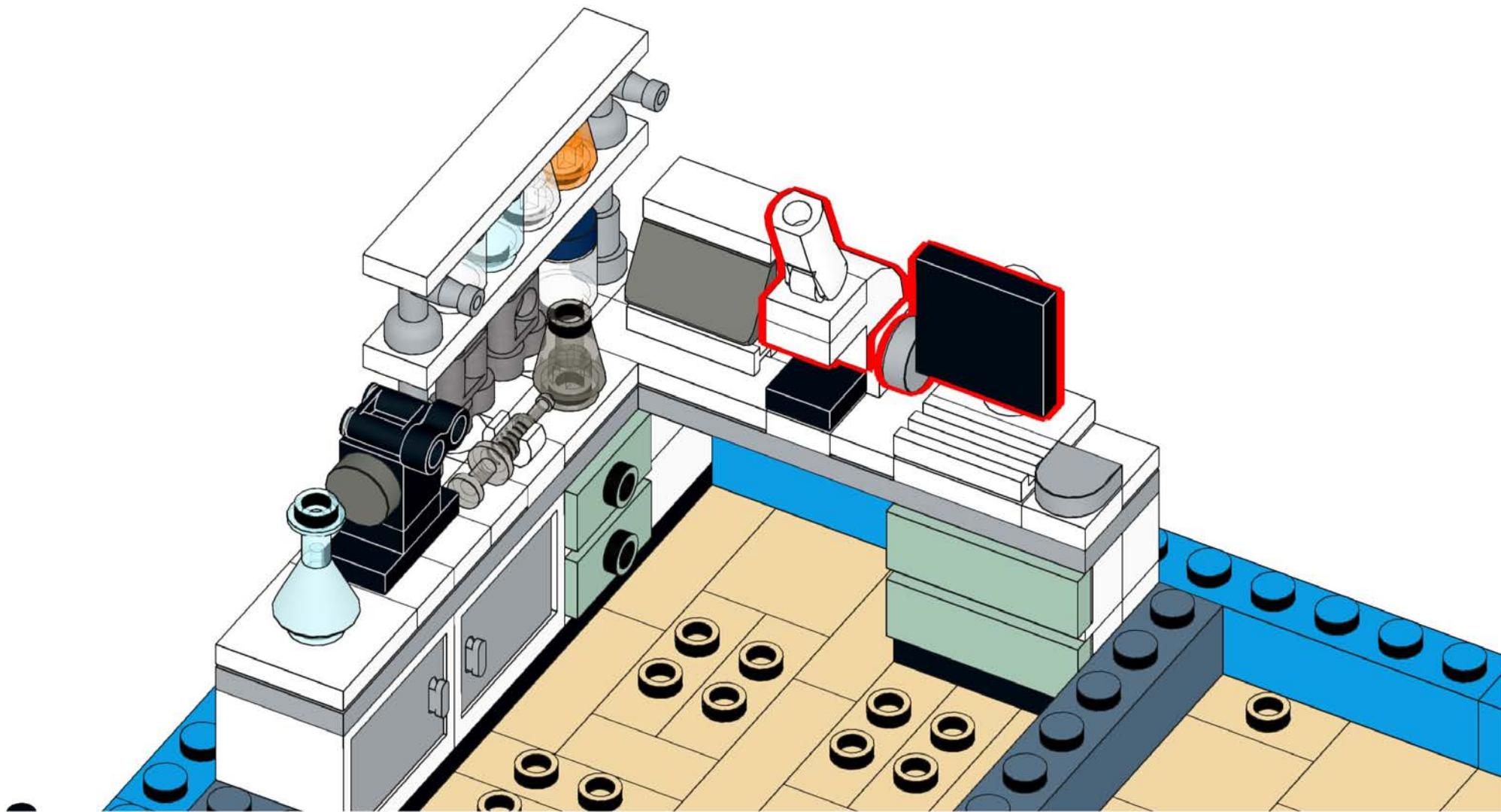
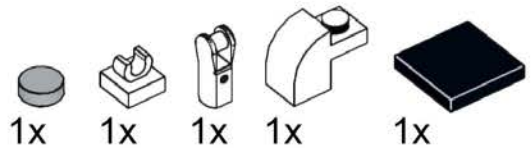

# 580

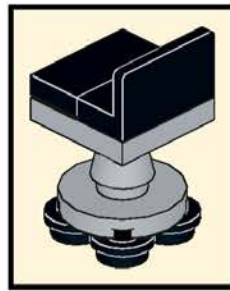
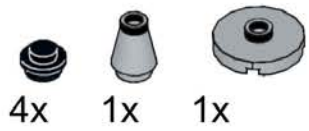

3x



# 581

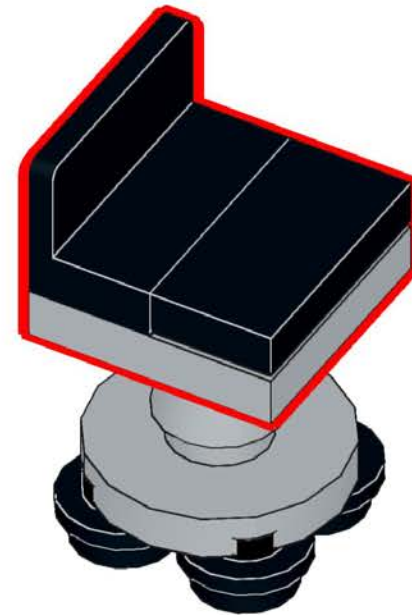
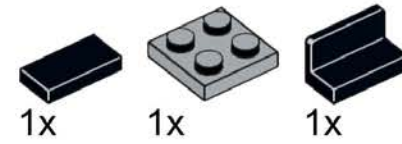

582

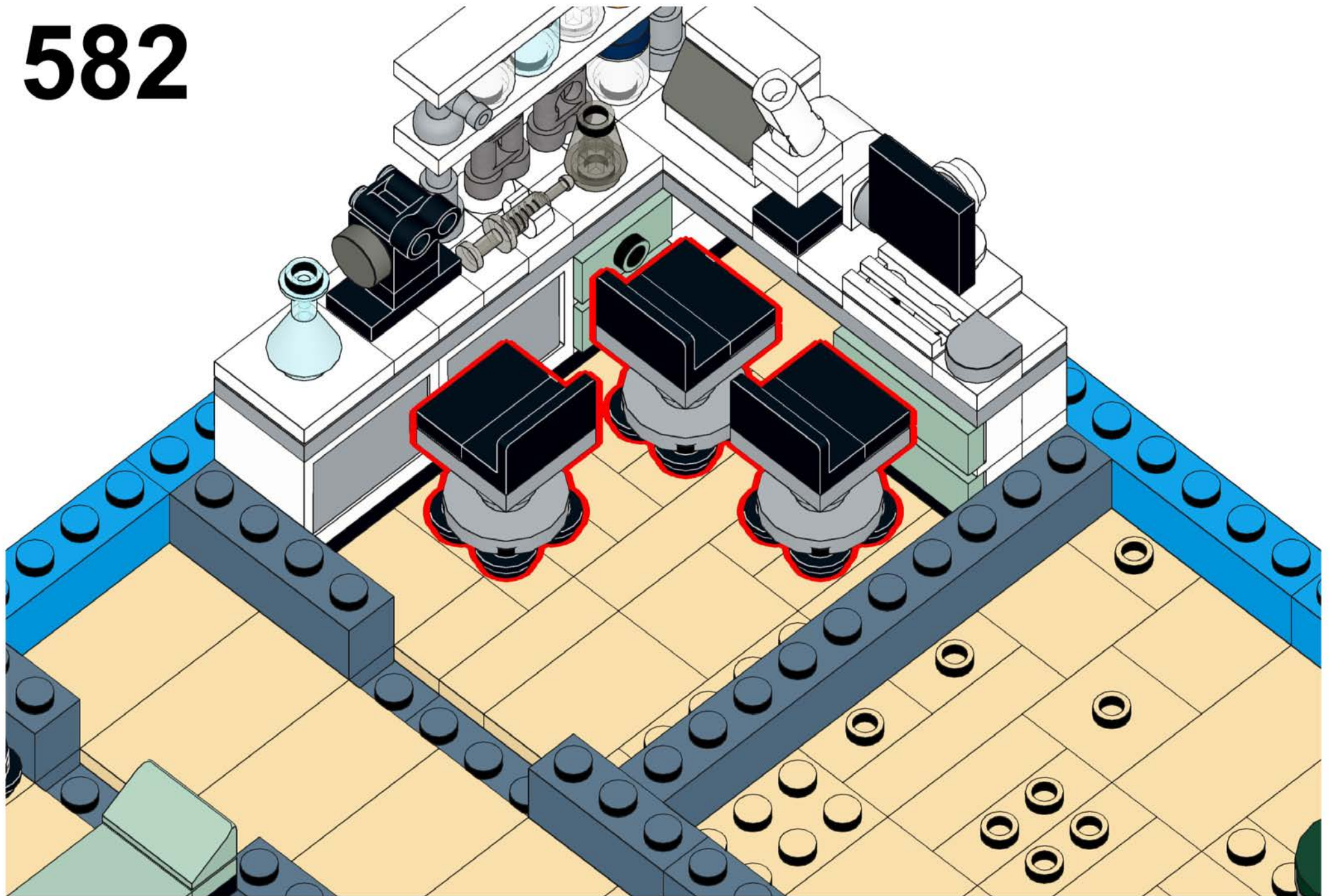

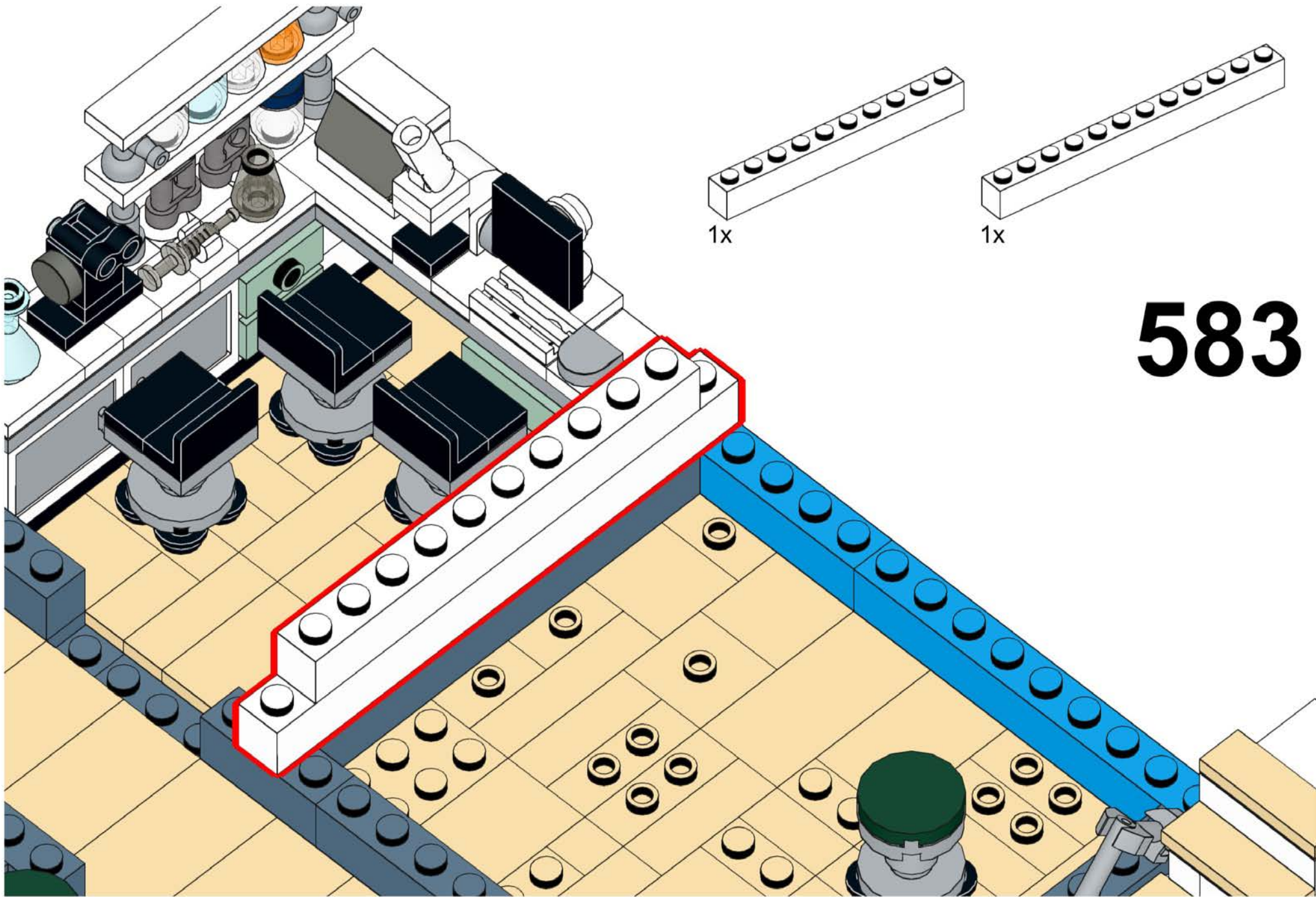

**583**

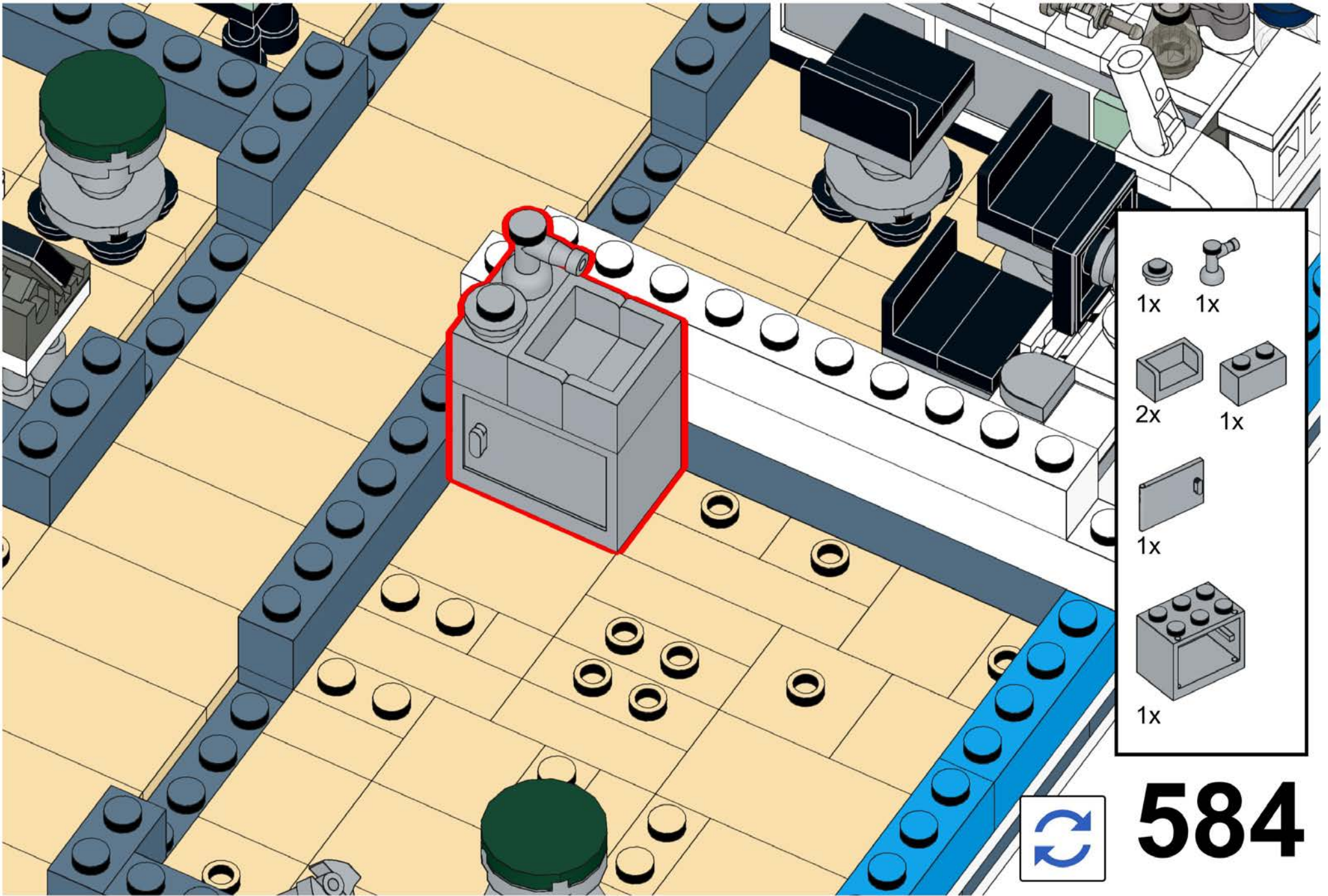

1x

1x

2x

1x

1x

1x





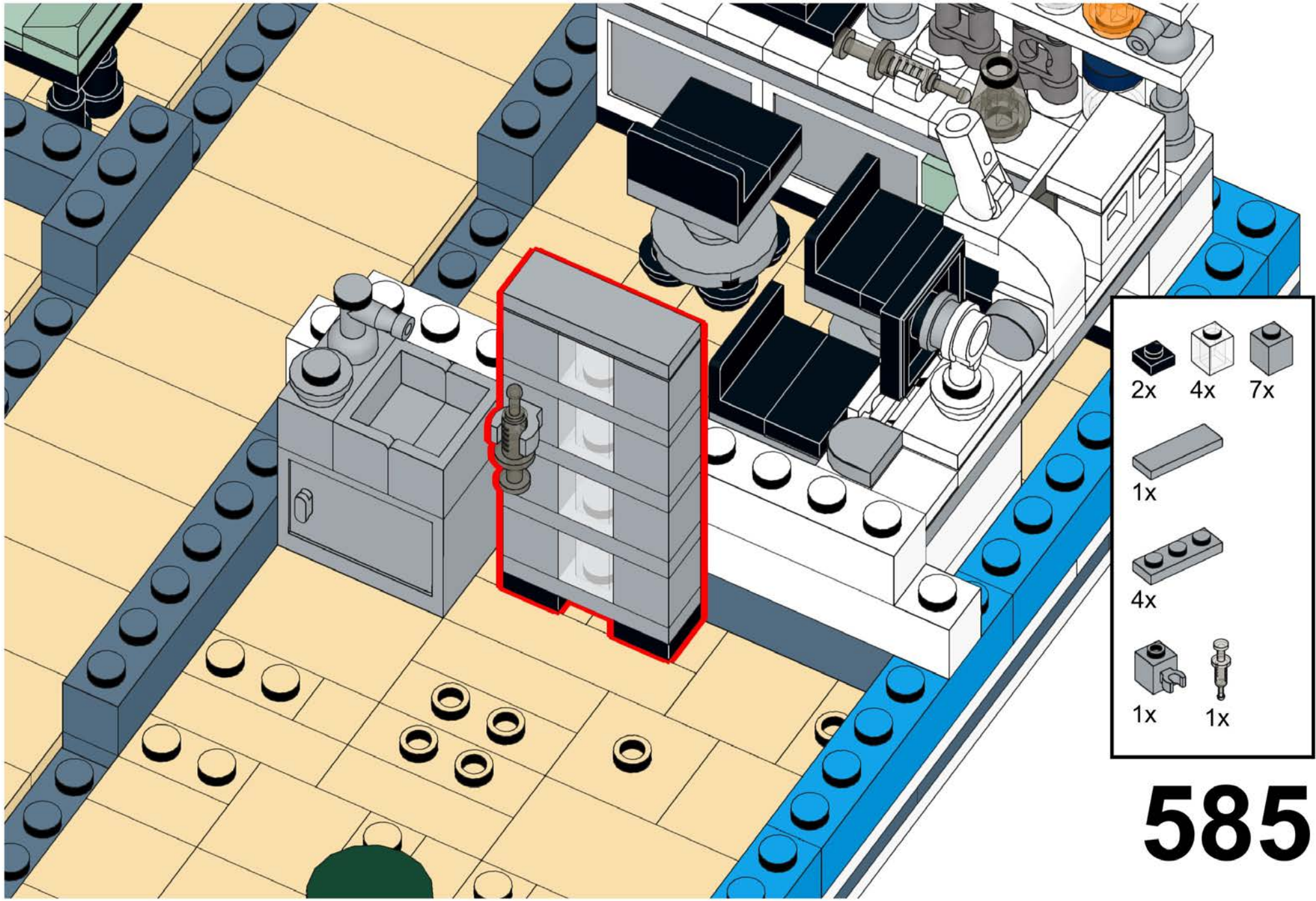

# 584



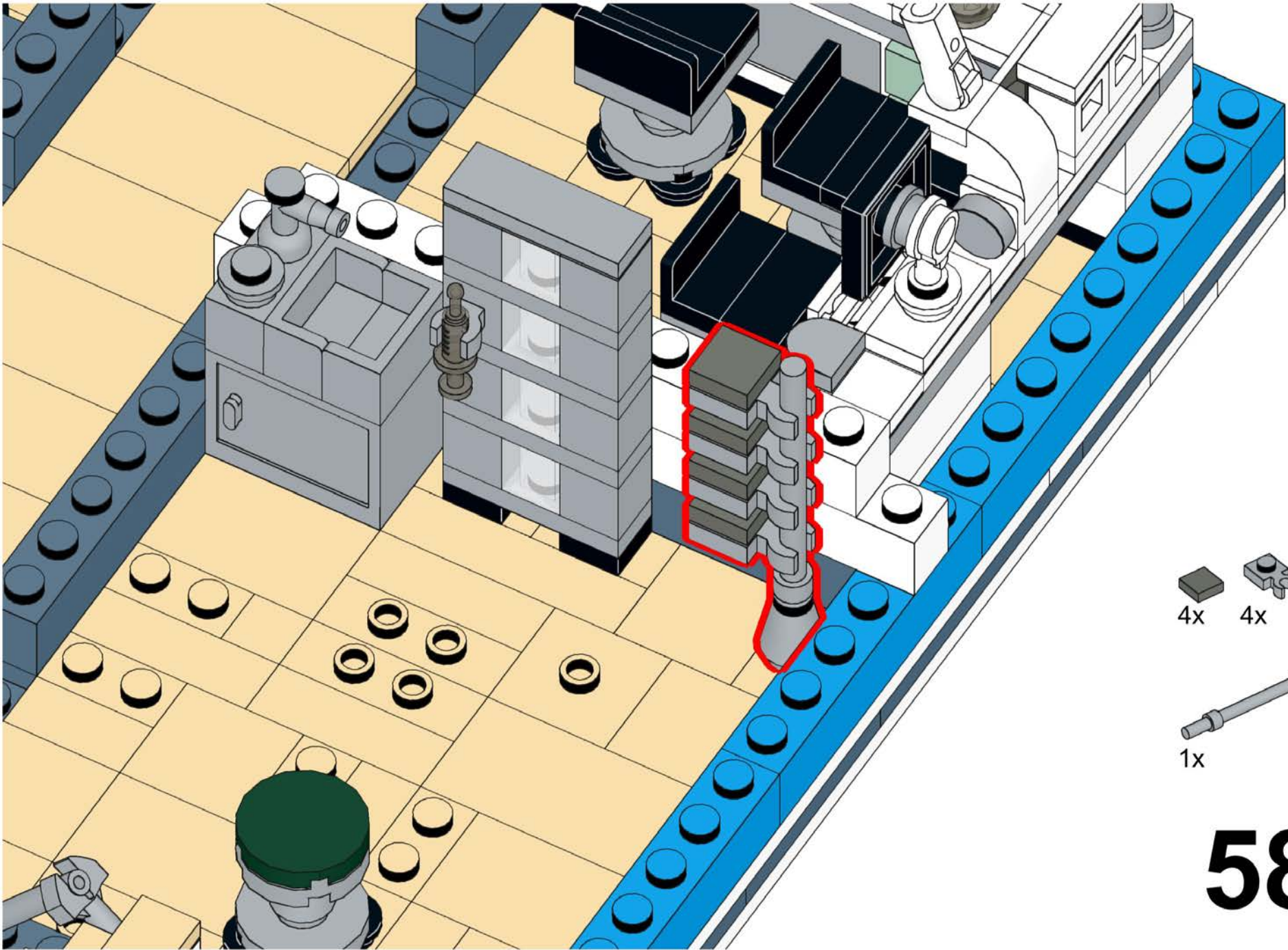

**585**

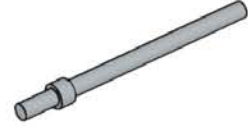

- 4x 
- 4x 
- 1x 

- 1x 

**586**

# 587

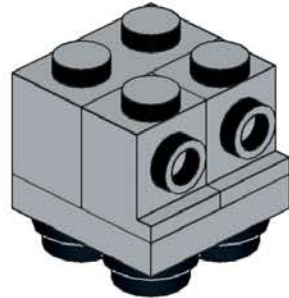
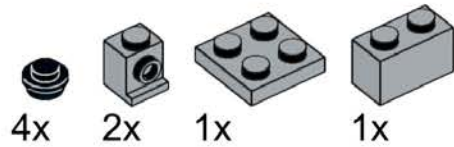

# 589

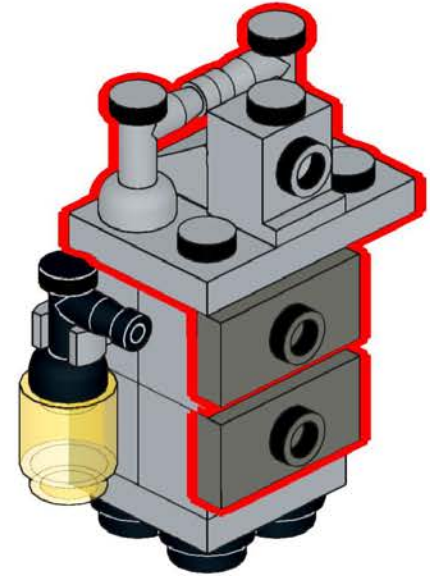
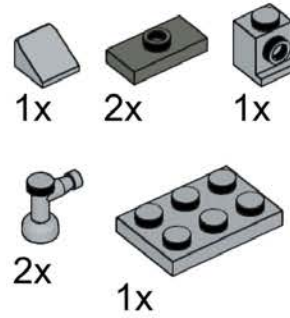

# 588

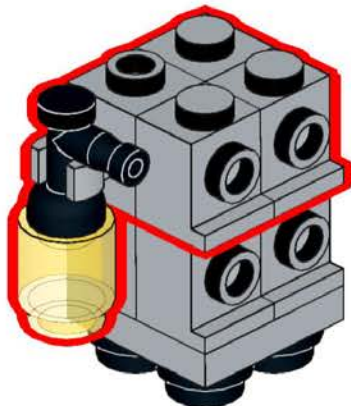
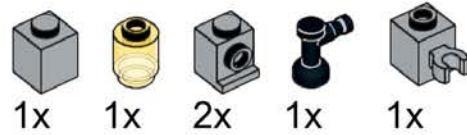

# 590

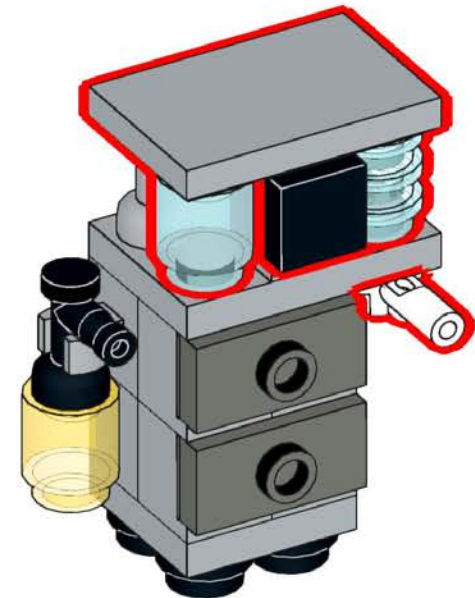
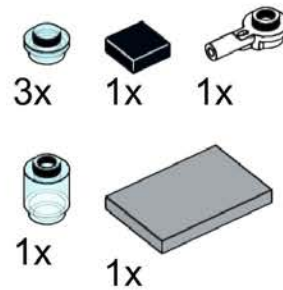

# 591

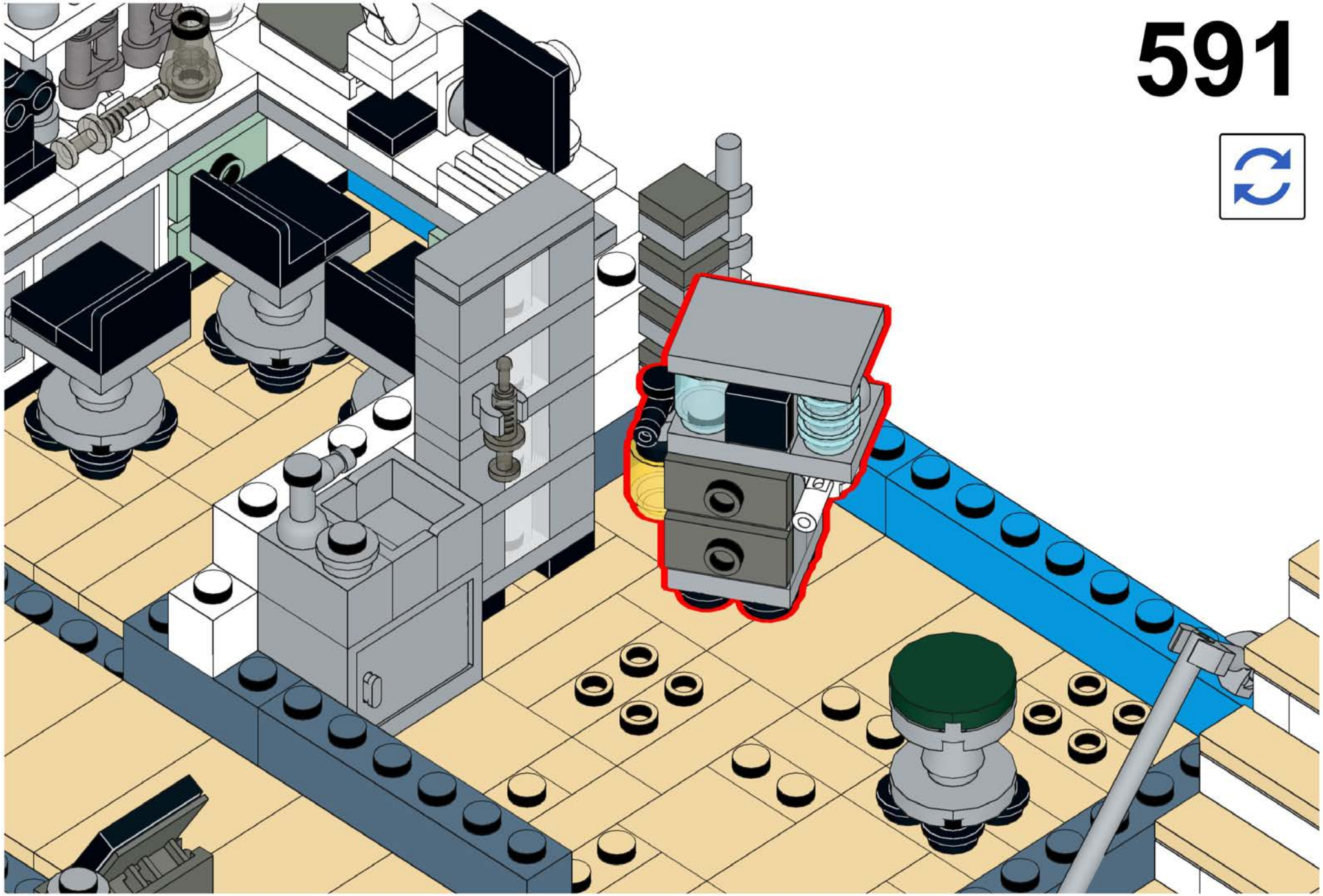

# 592

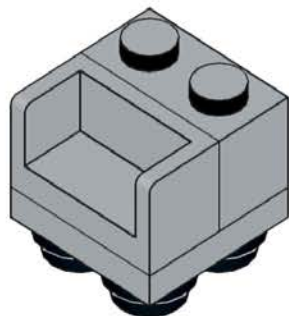
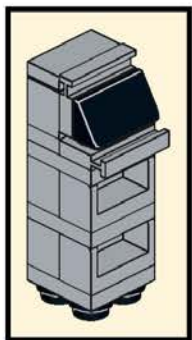
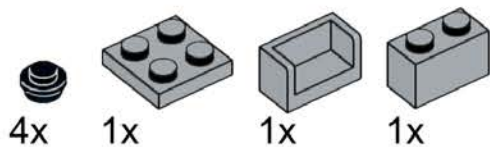

# 594

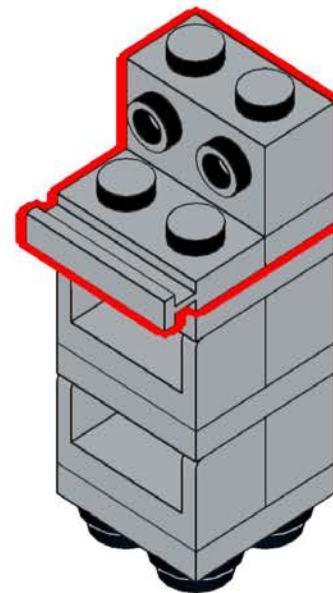
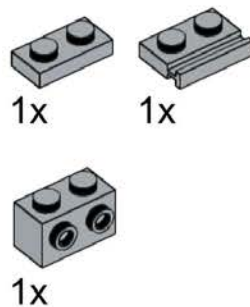

# 593

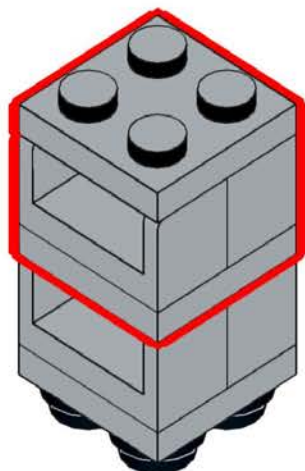
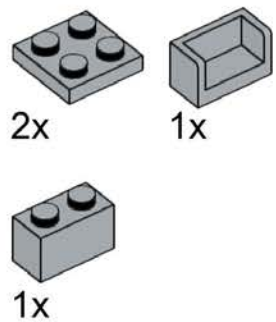

# 595

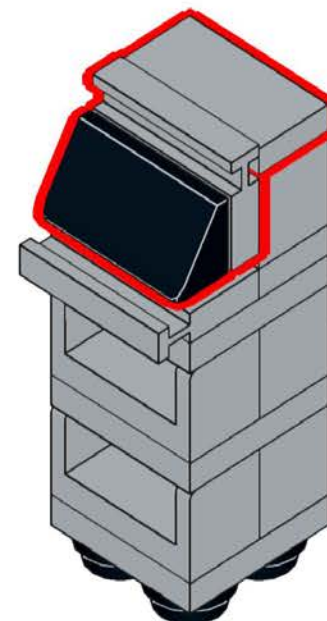
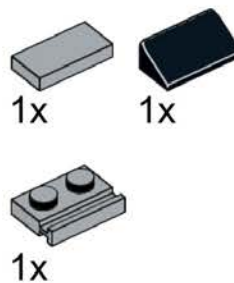

# 596

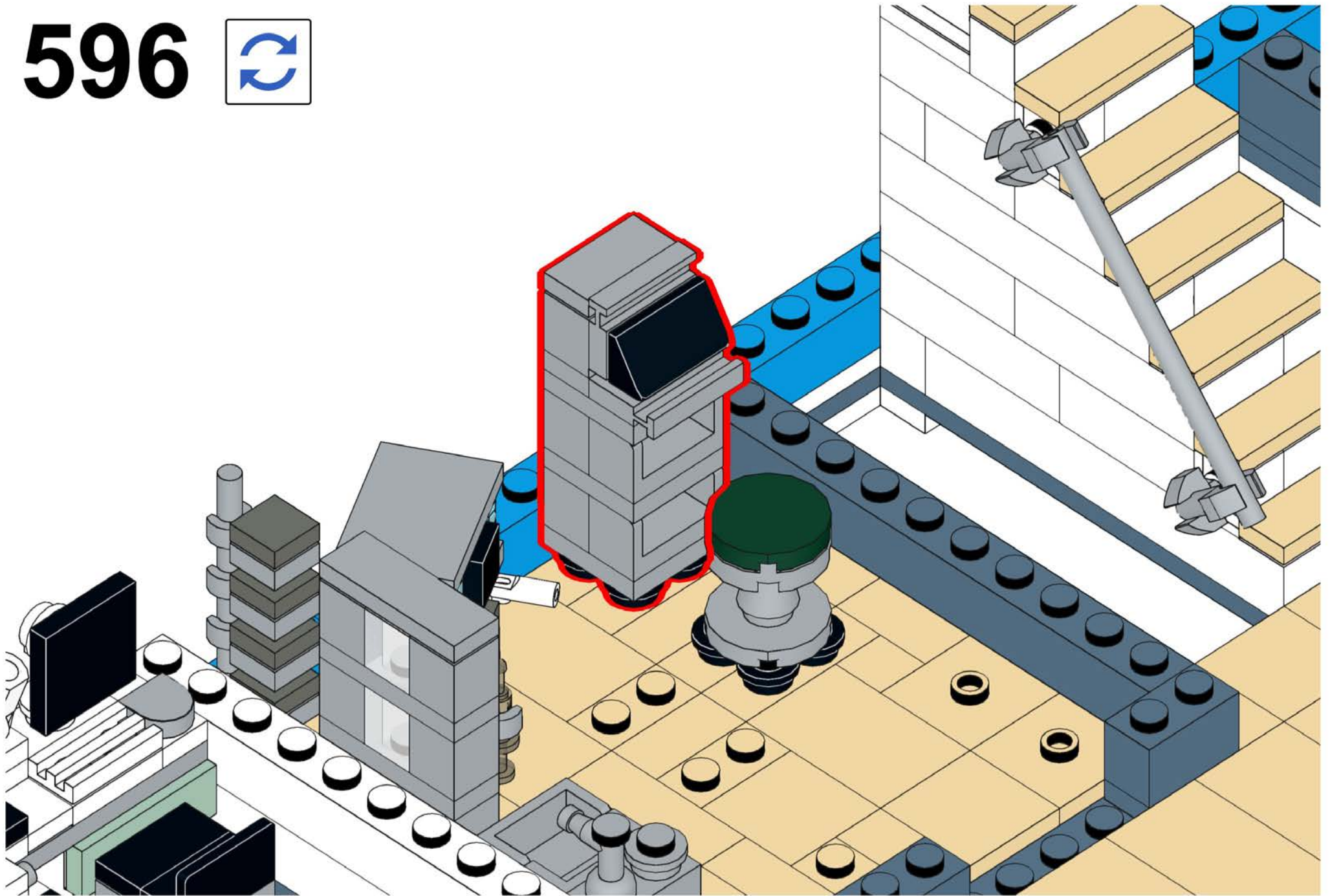

# 597

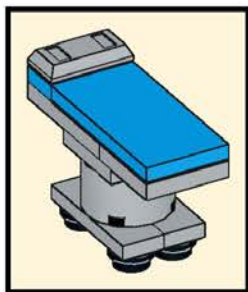
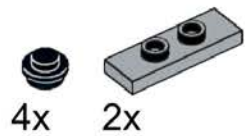

# 598

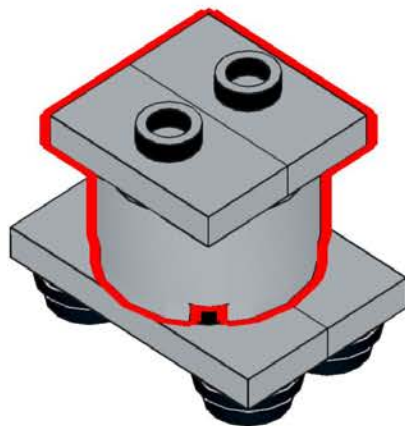
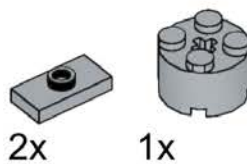

# 599

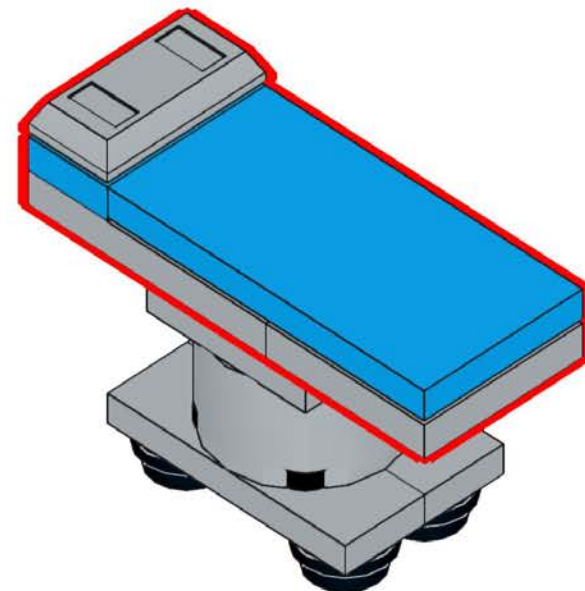
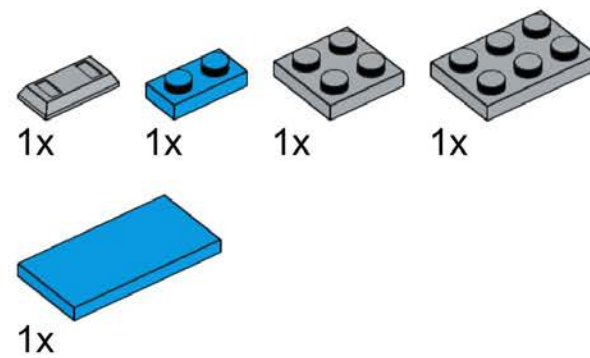

600

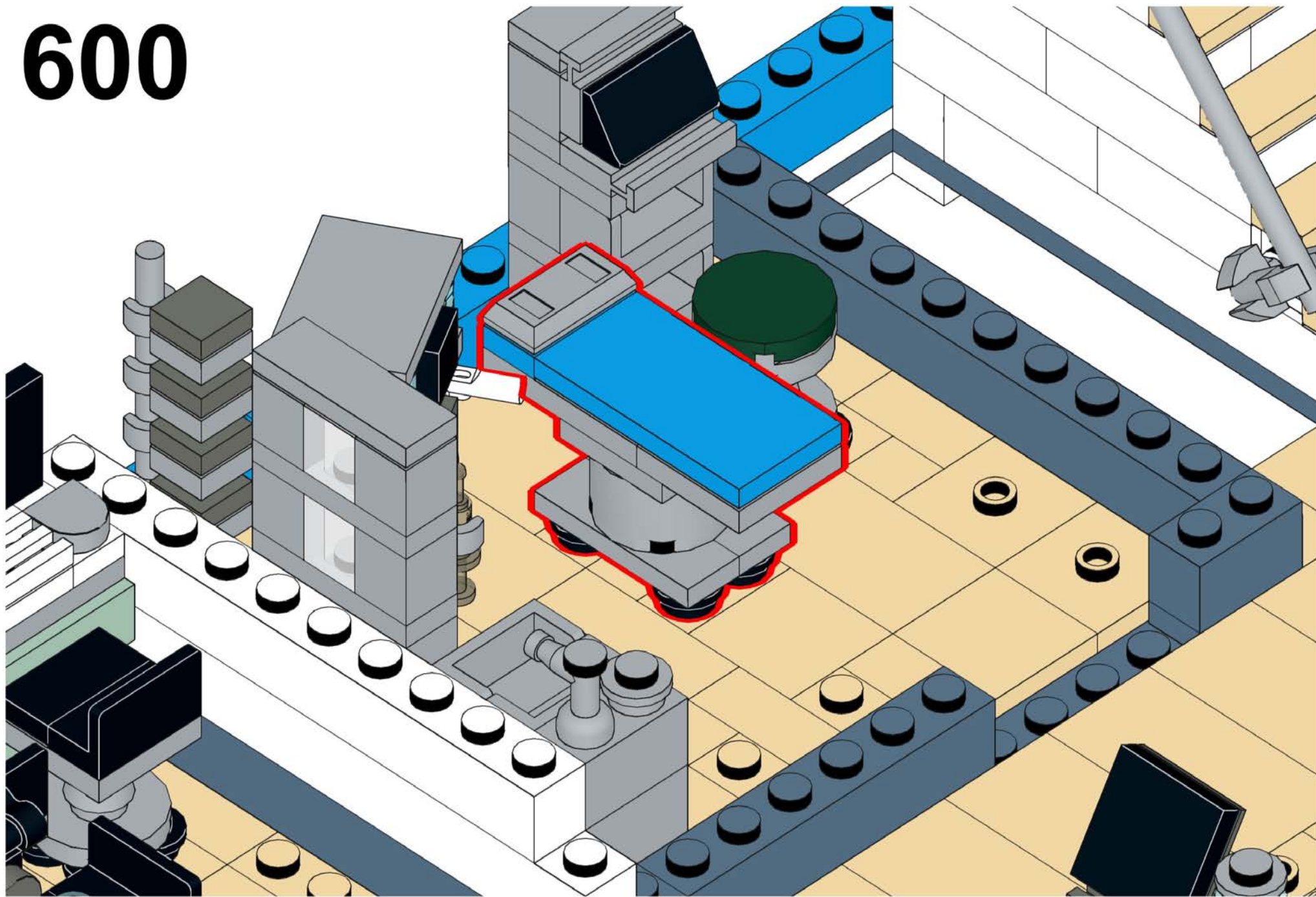



# 601

4x

1x

1x

1x

1x

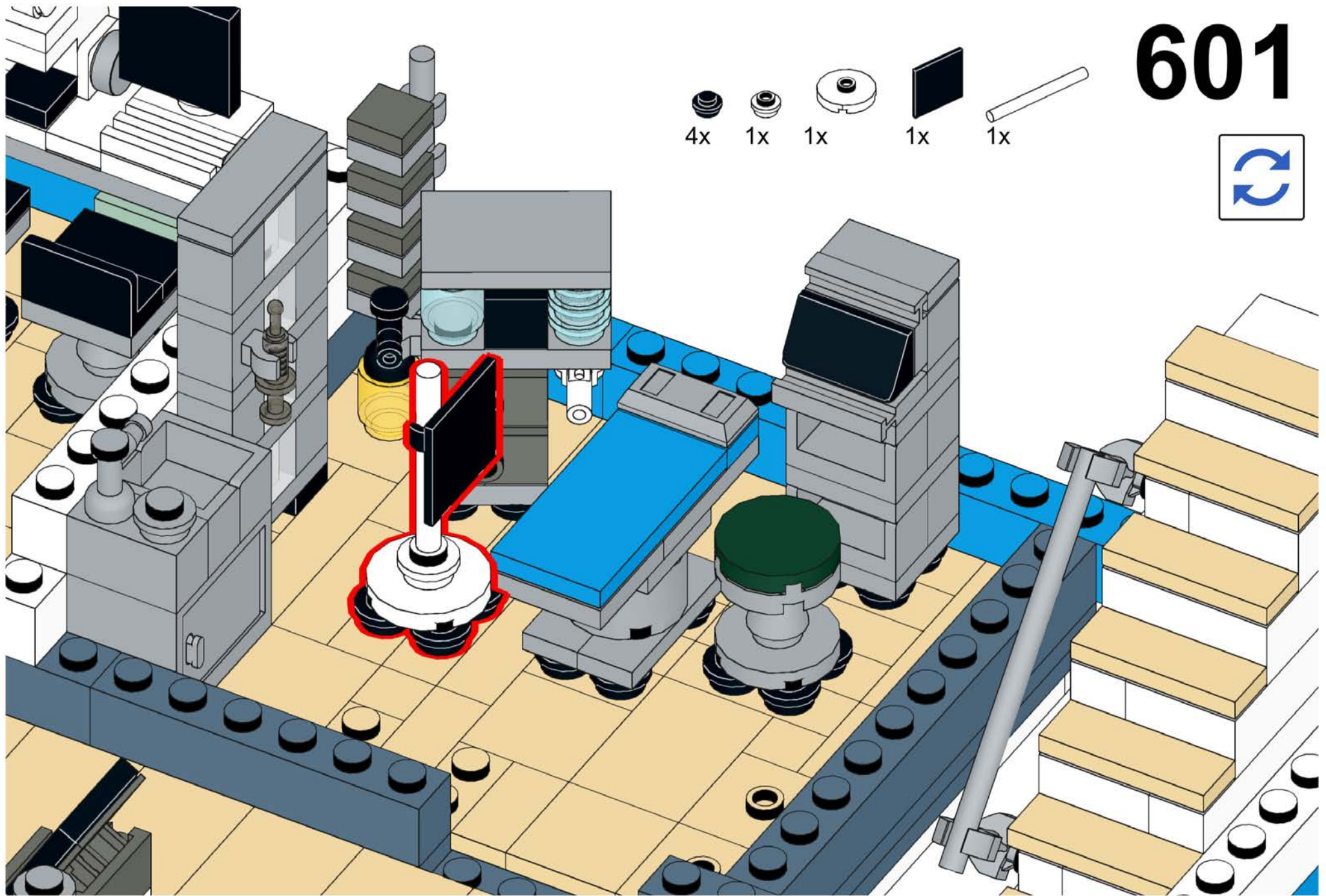

# 602

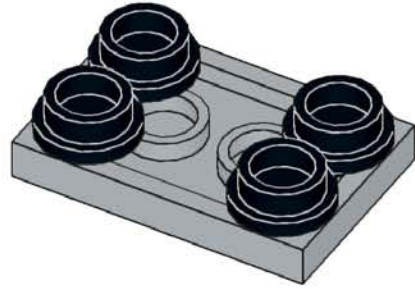
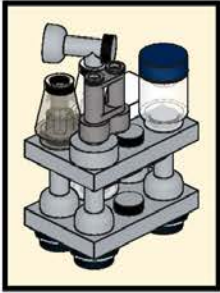
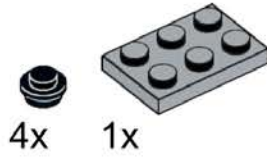

# 604

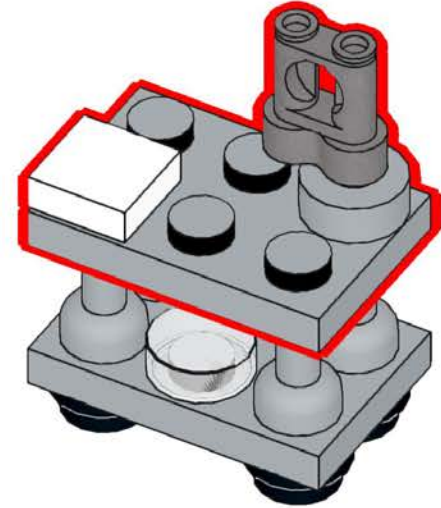
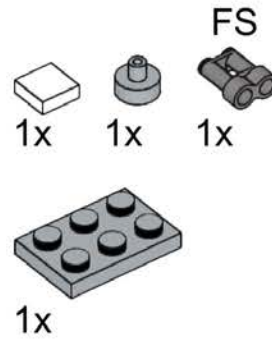

# 603

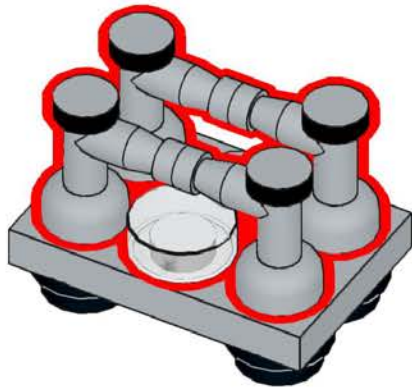
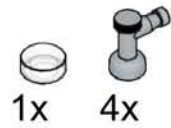

# 605

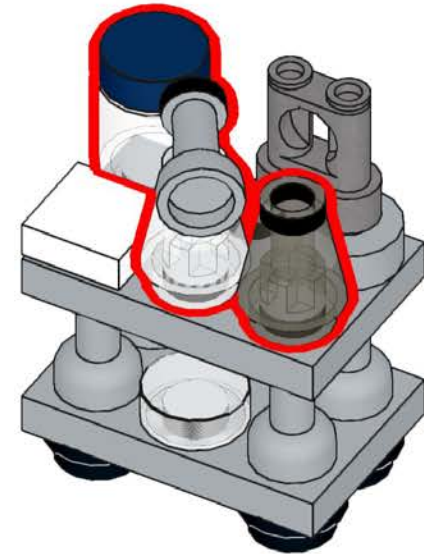

606

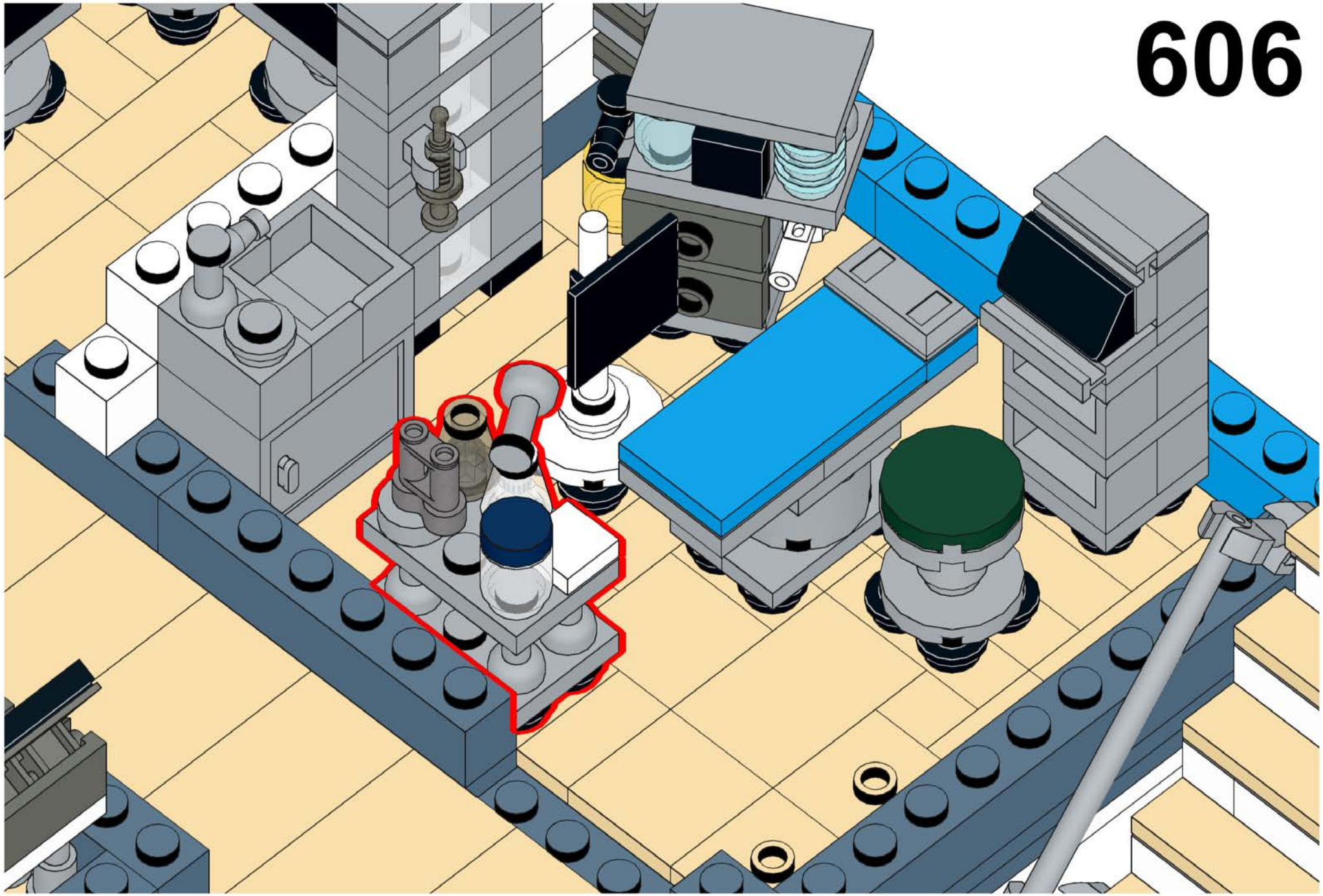

# 607



4x	1x	1x	2x	1x	1x

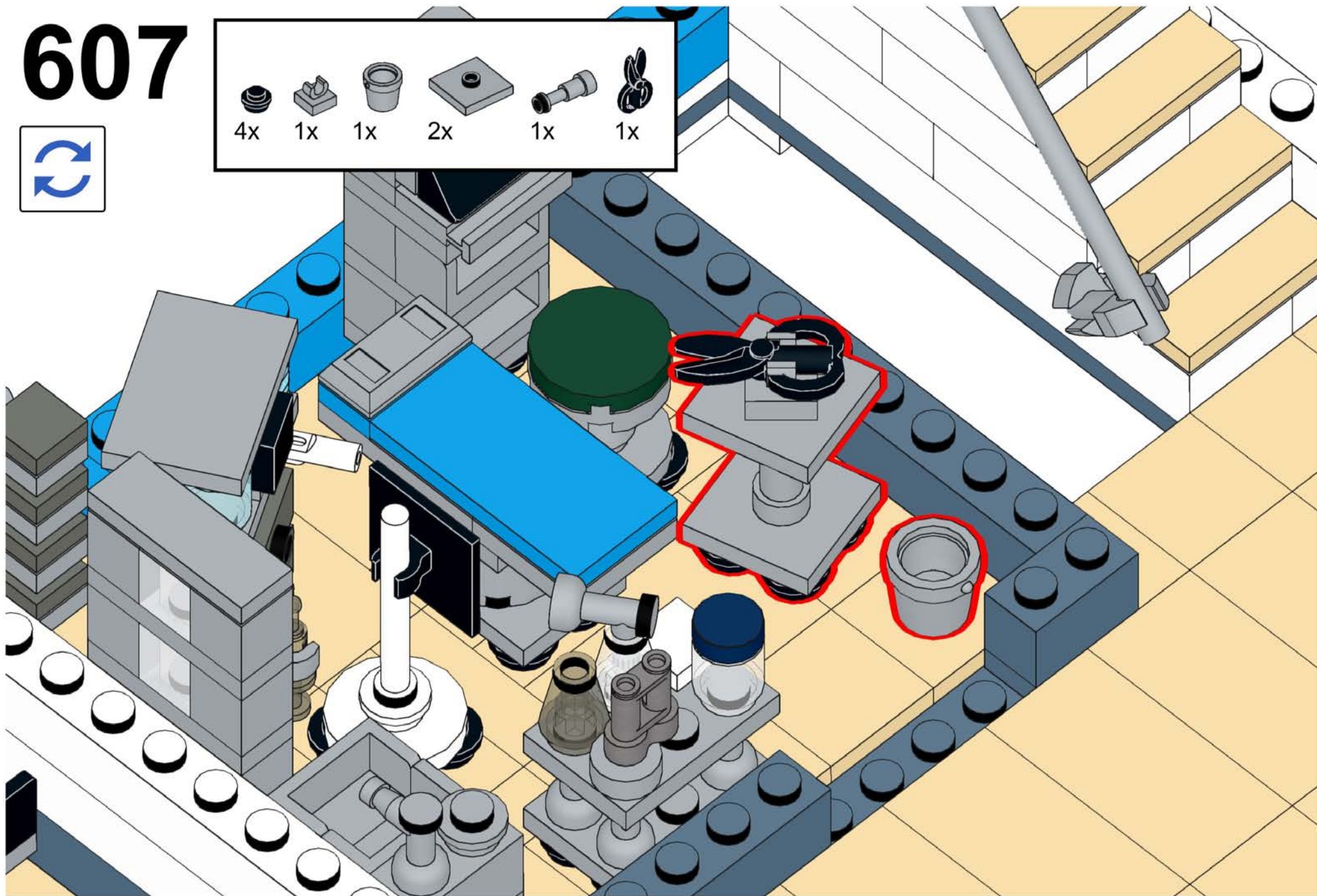

# 608

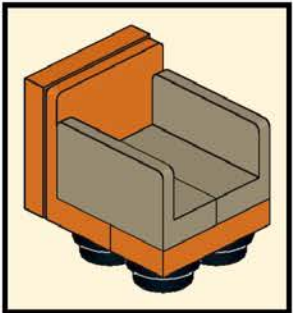
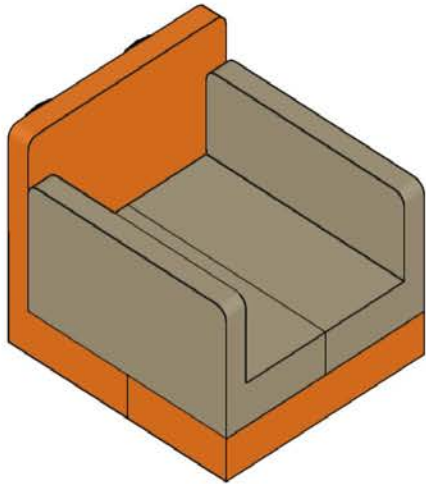
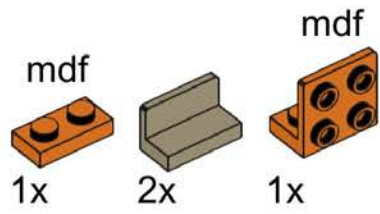

# 609

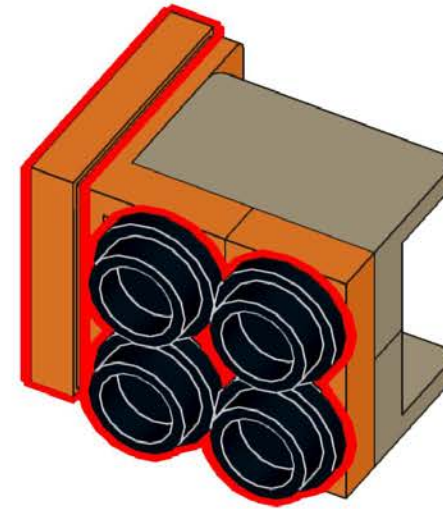
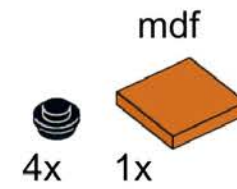

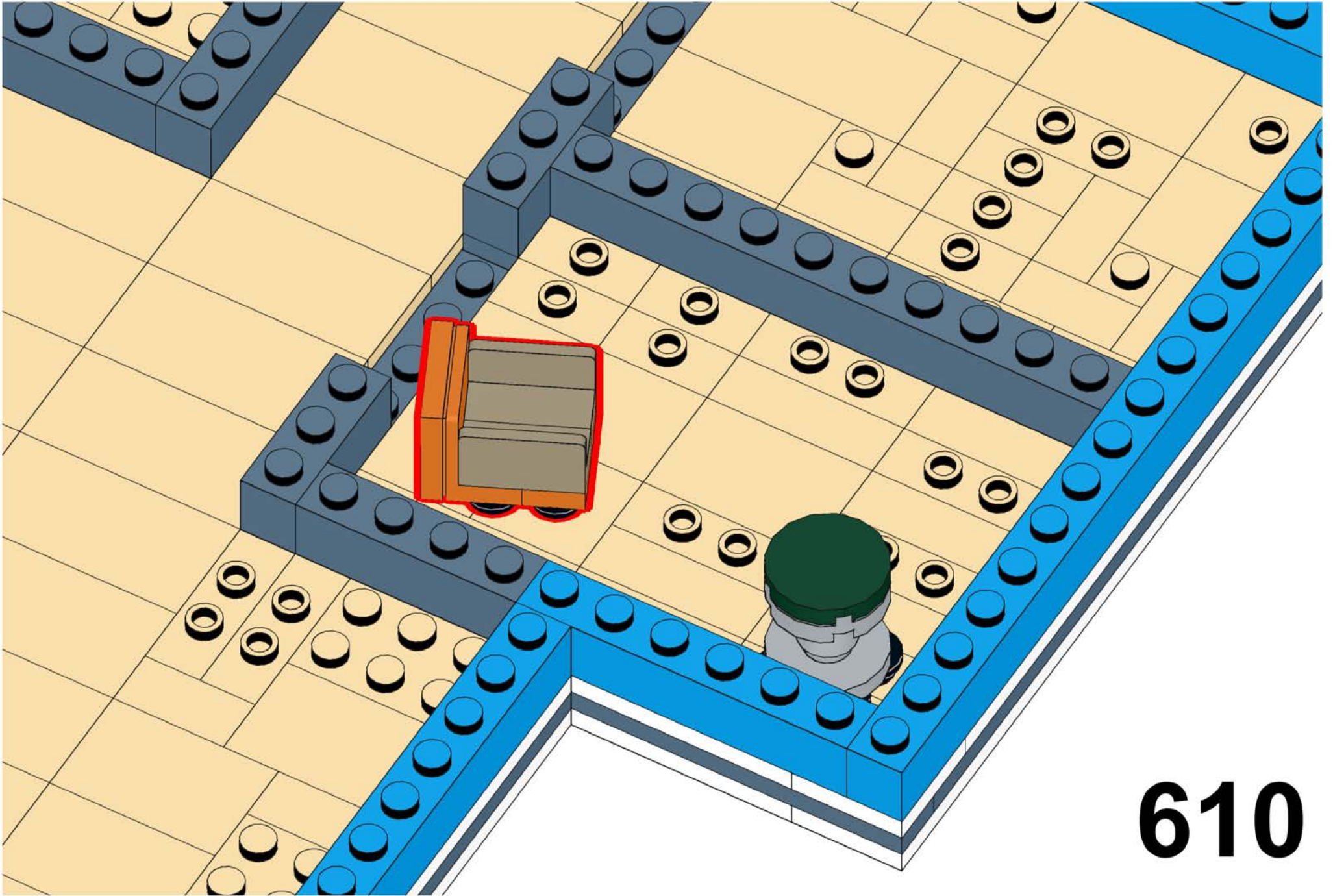

**610**

# 611

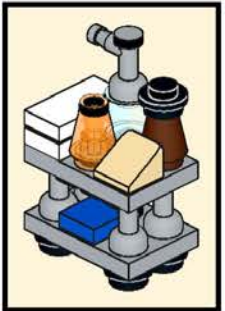
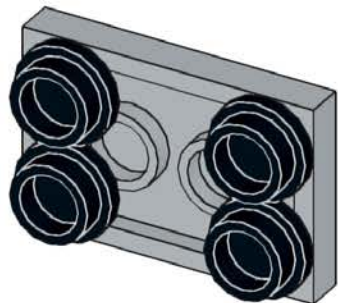
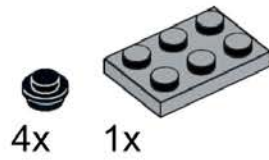

# 612

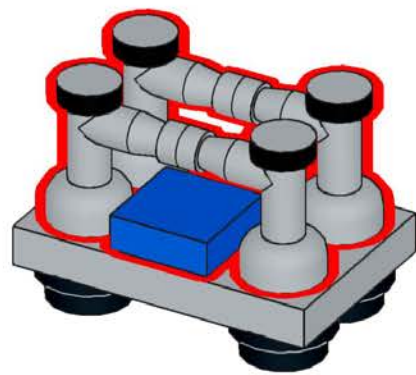
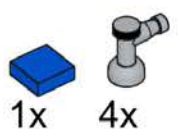

# 613

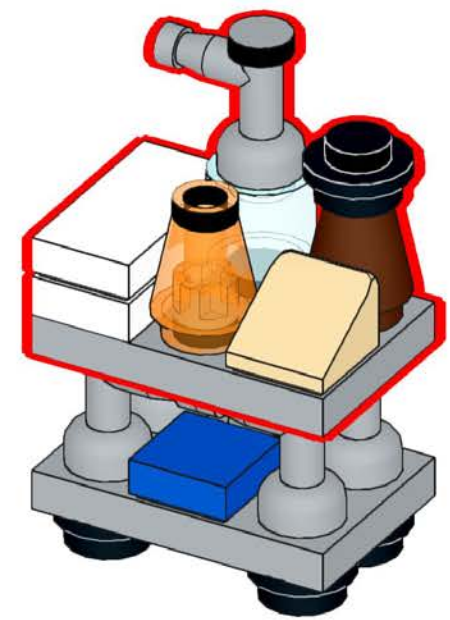
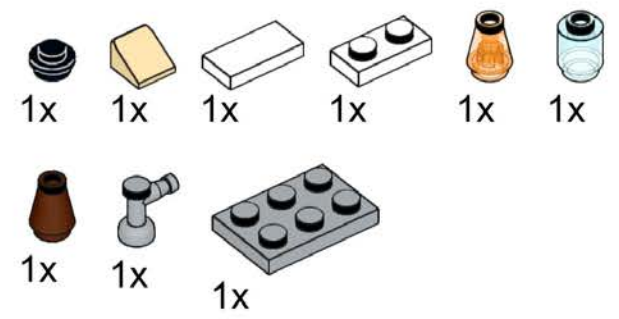

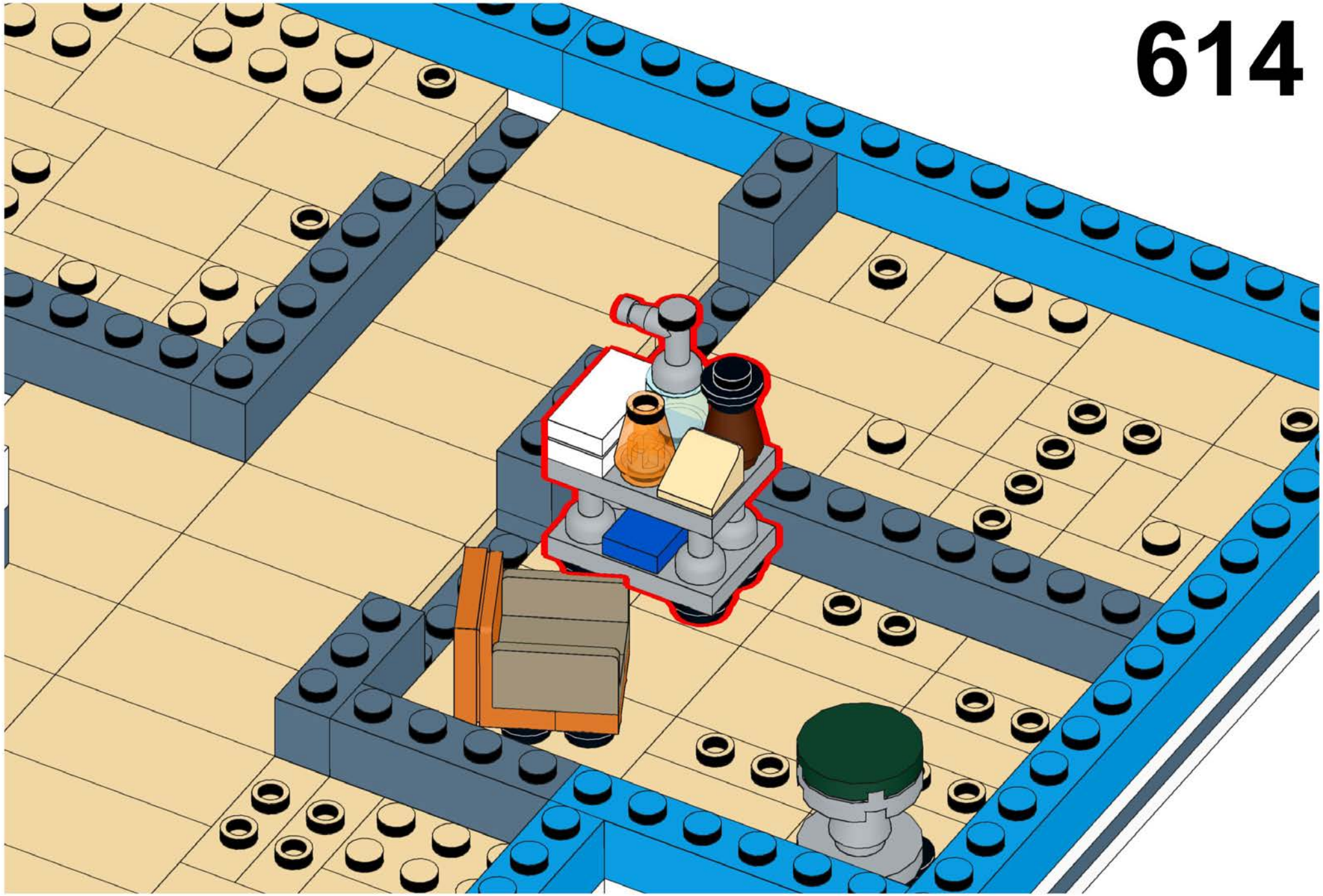

614



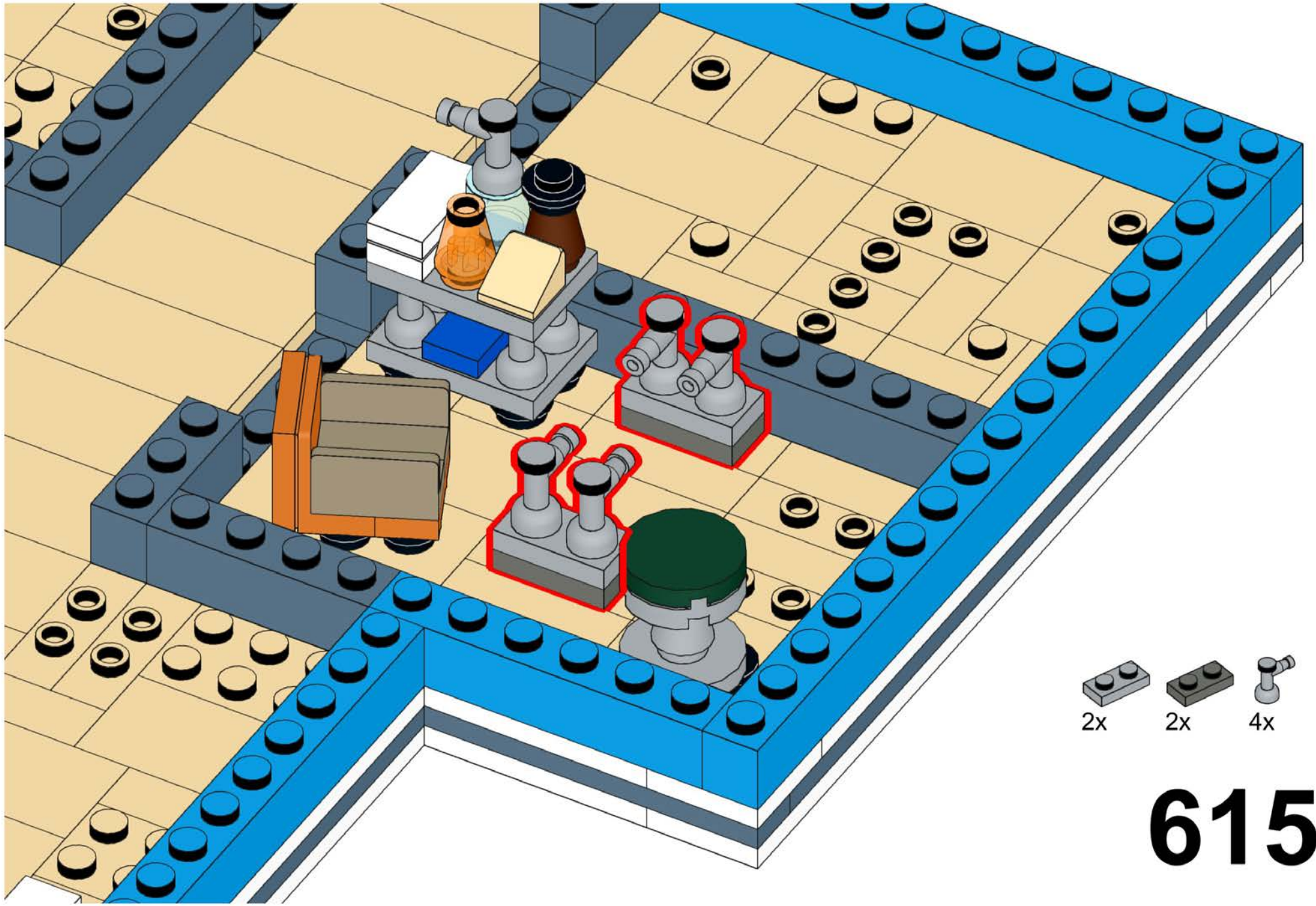



- 2x 
- 2x 
- 4x 

**615**

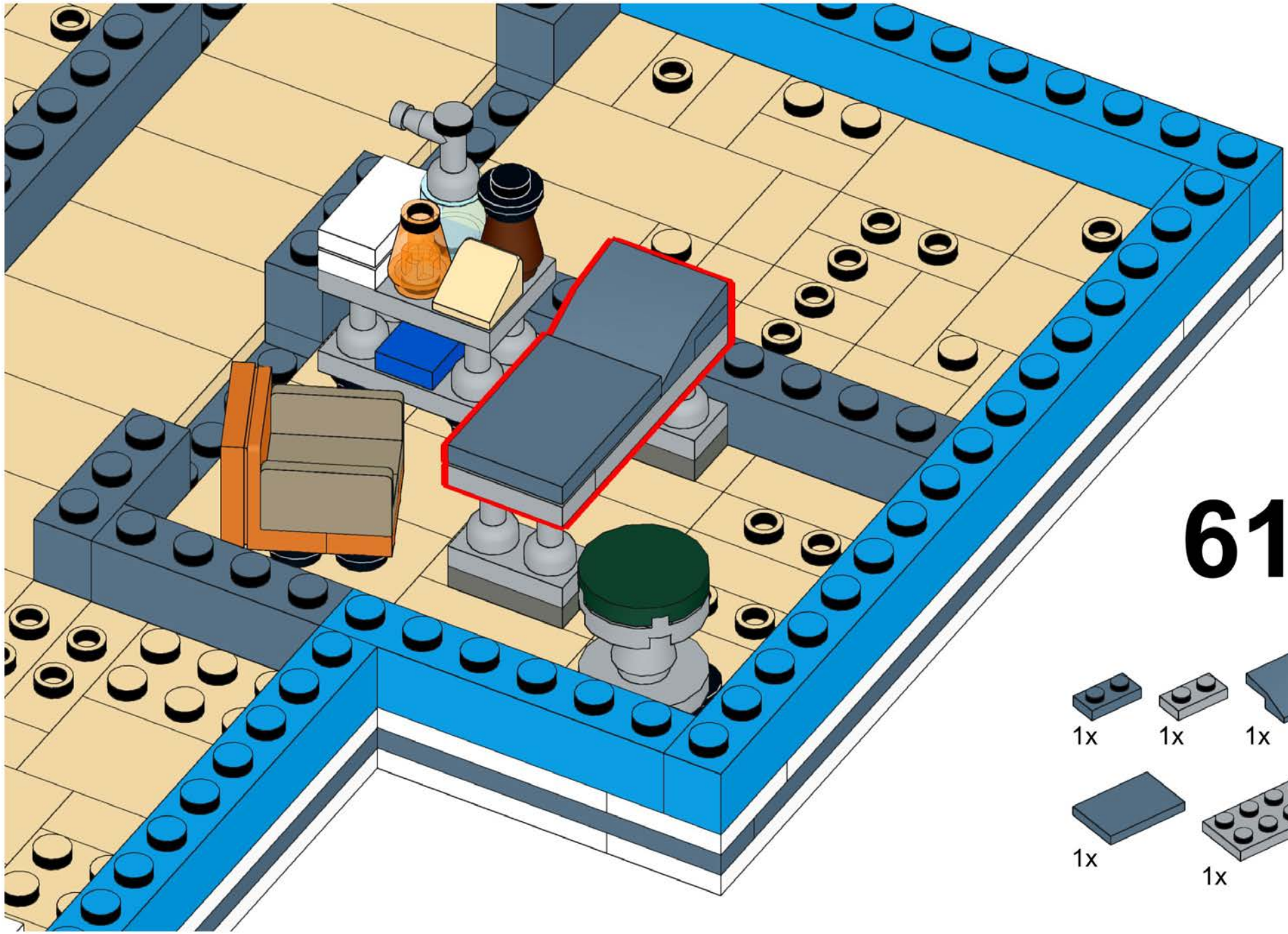

**616**

- 1x
- 1x
- 1x
- 1x
- 1x

# 617

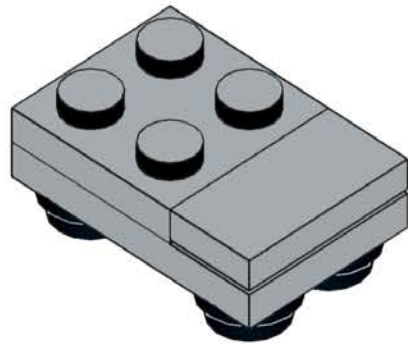
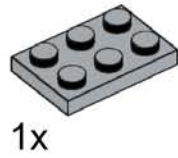
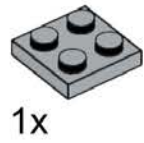
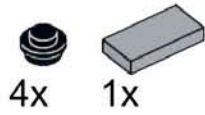

# 618

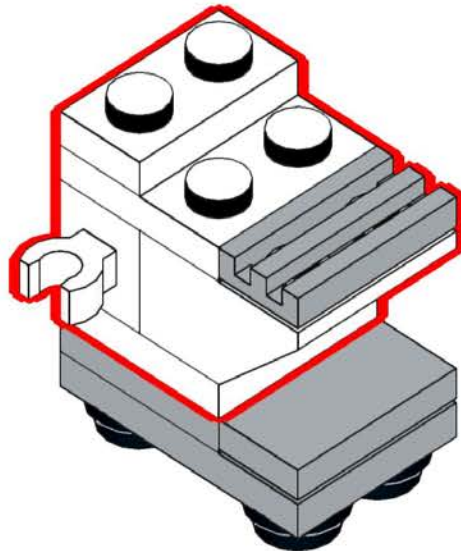
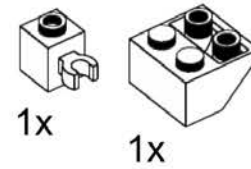
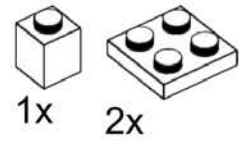
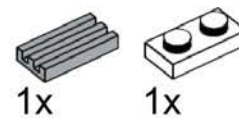



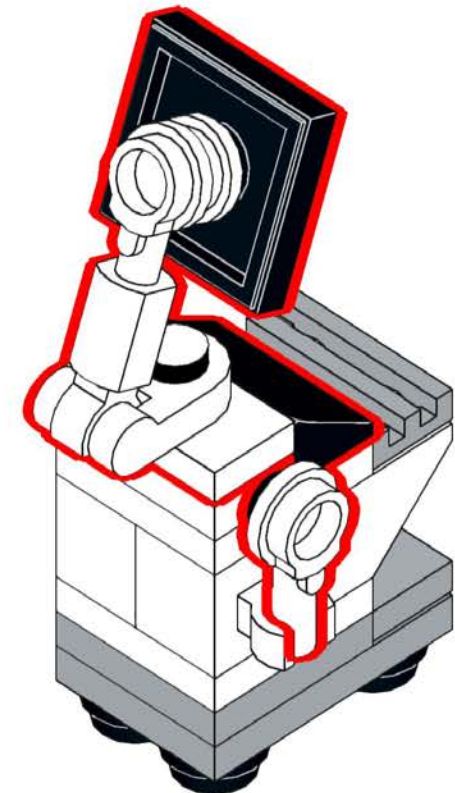
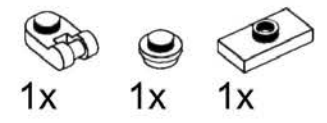

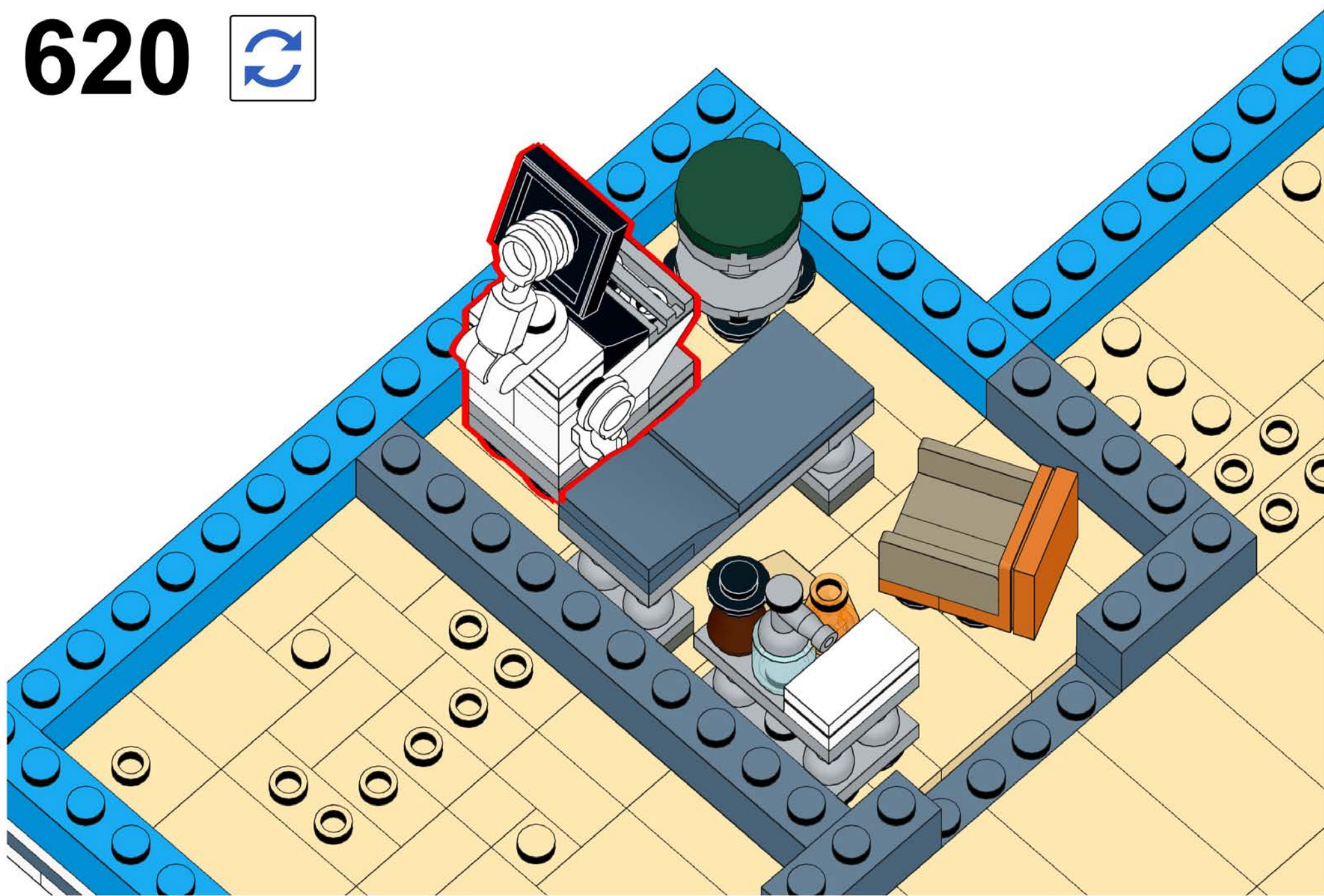

# 619

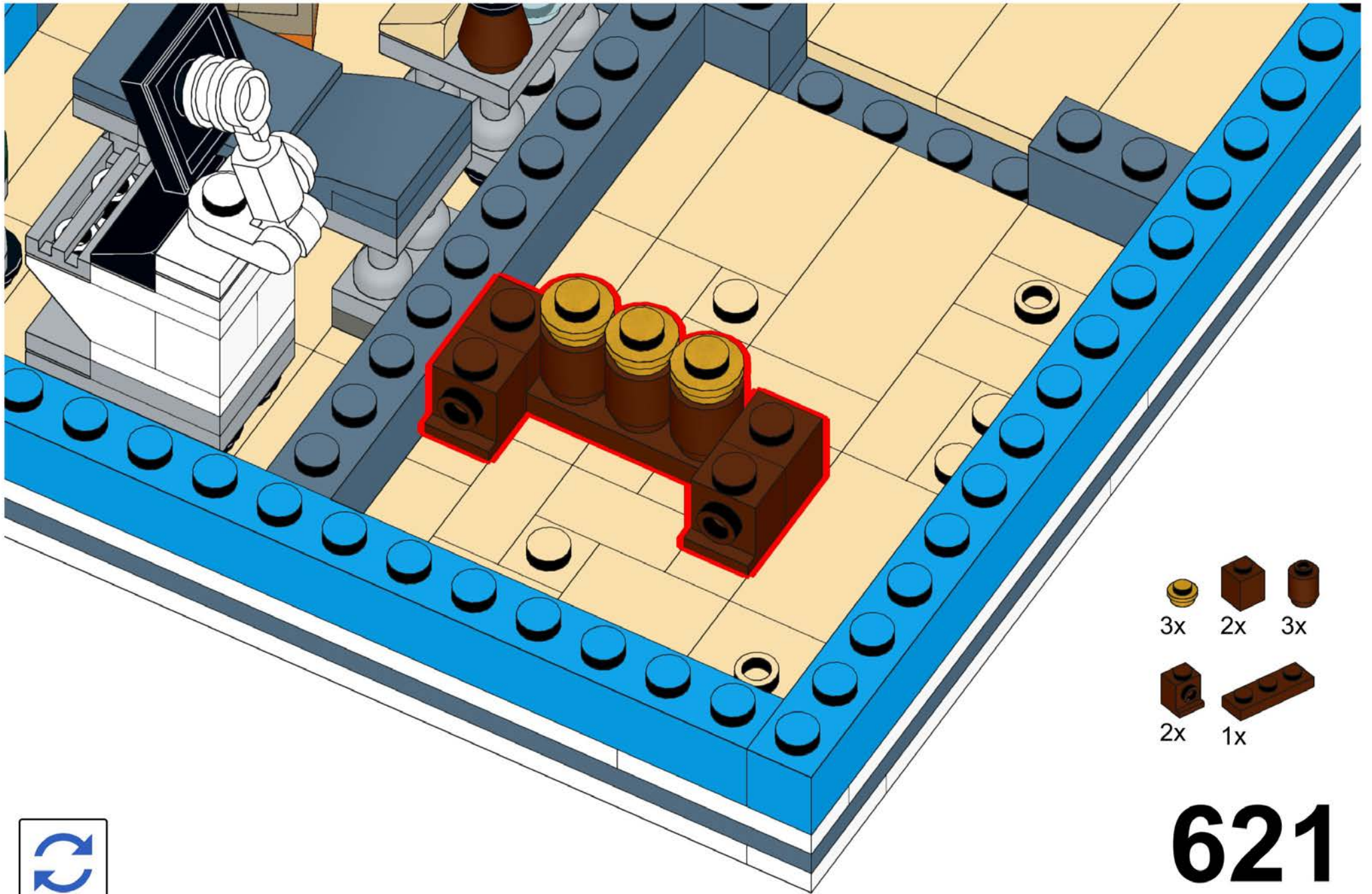

# 620









- 3x 
- 2x 
- 3x 
- 2x 
- 1x 

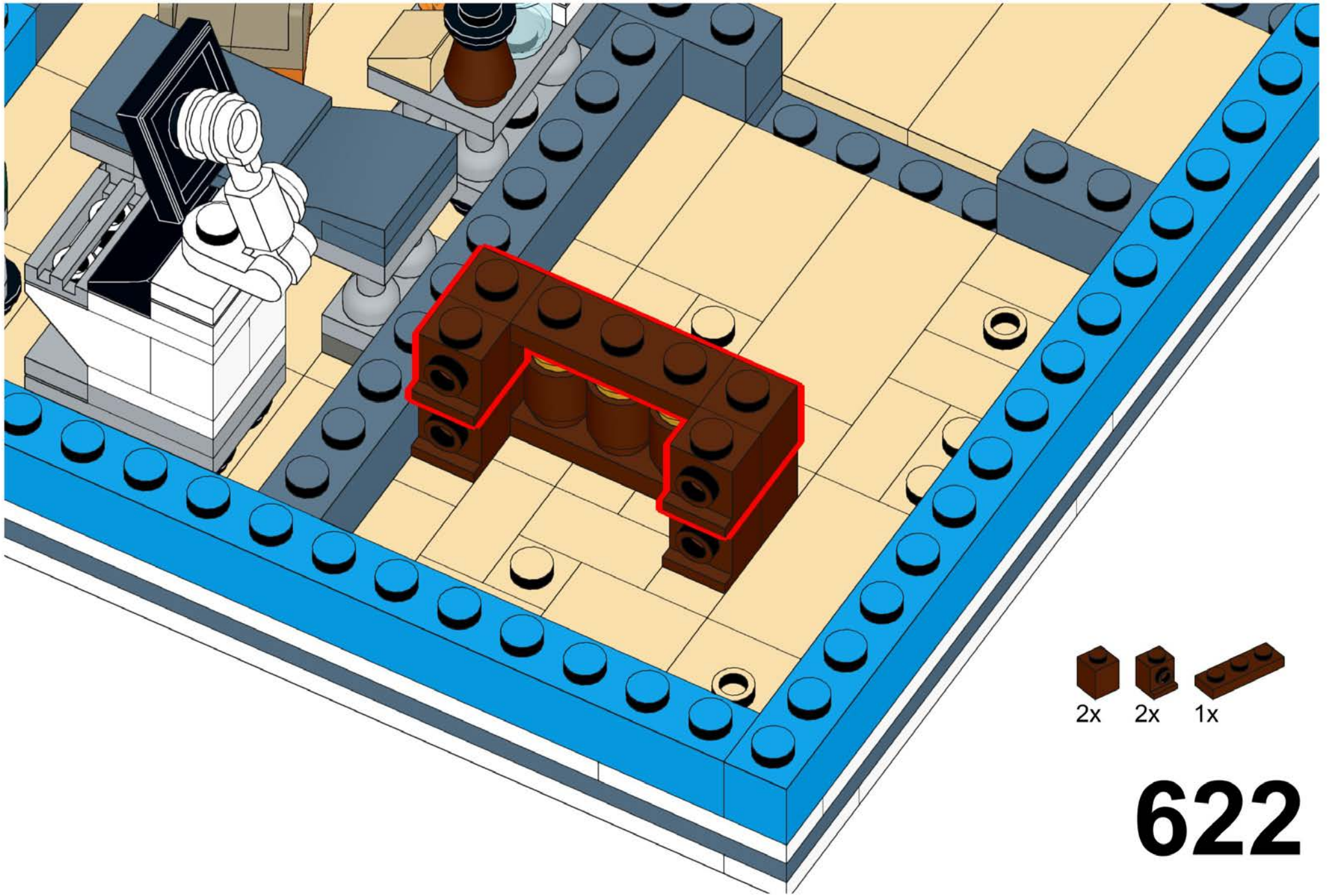







621

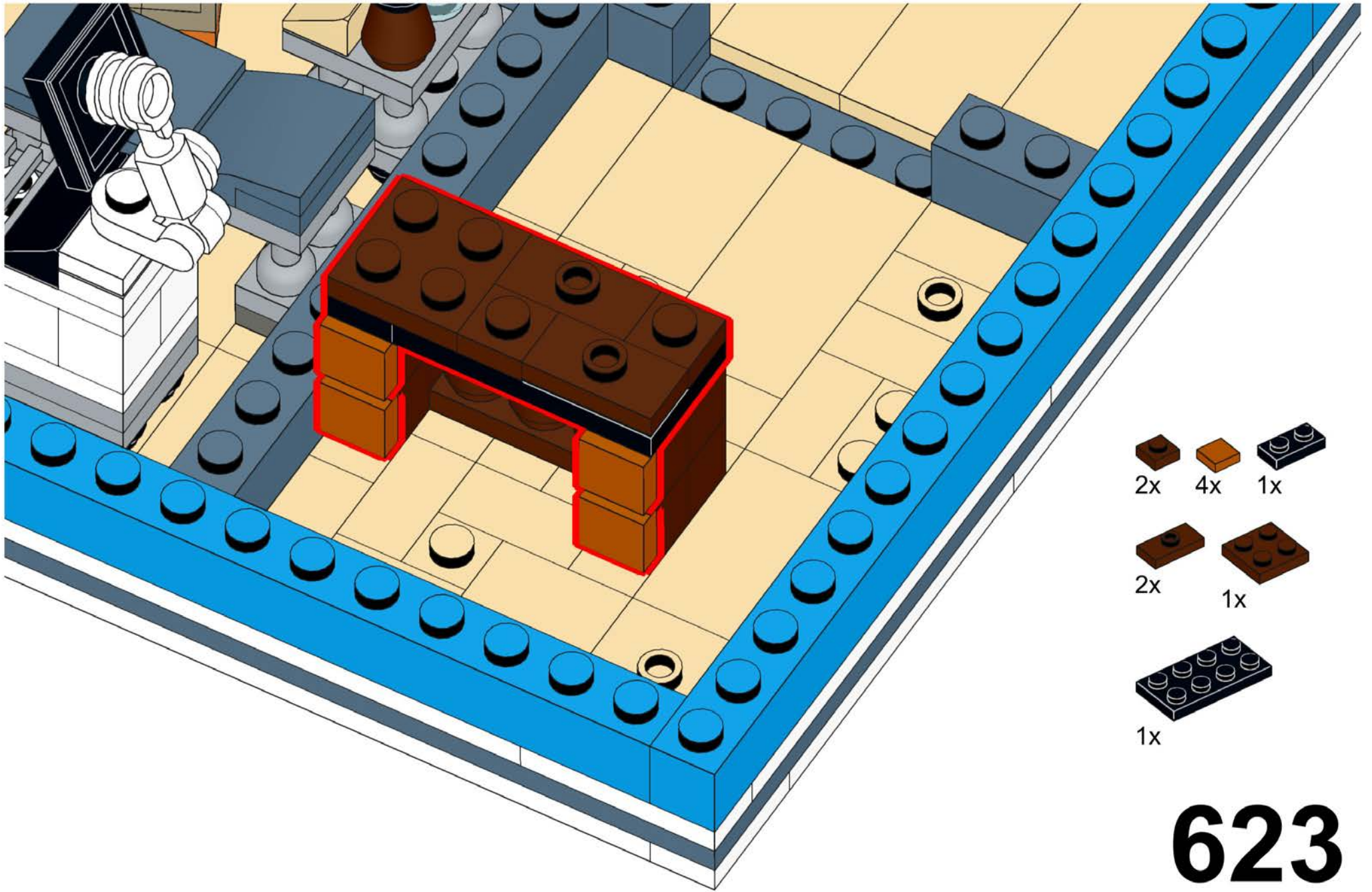

- 2x 
- 2x 
- 1x 

622



- 2x  4x  1x 
- 2x  1x 
- 1x 

623

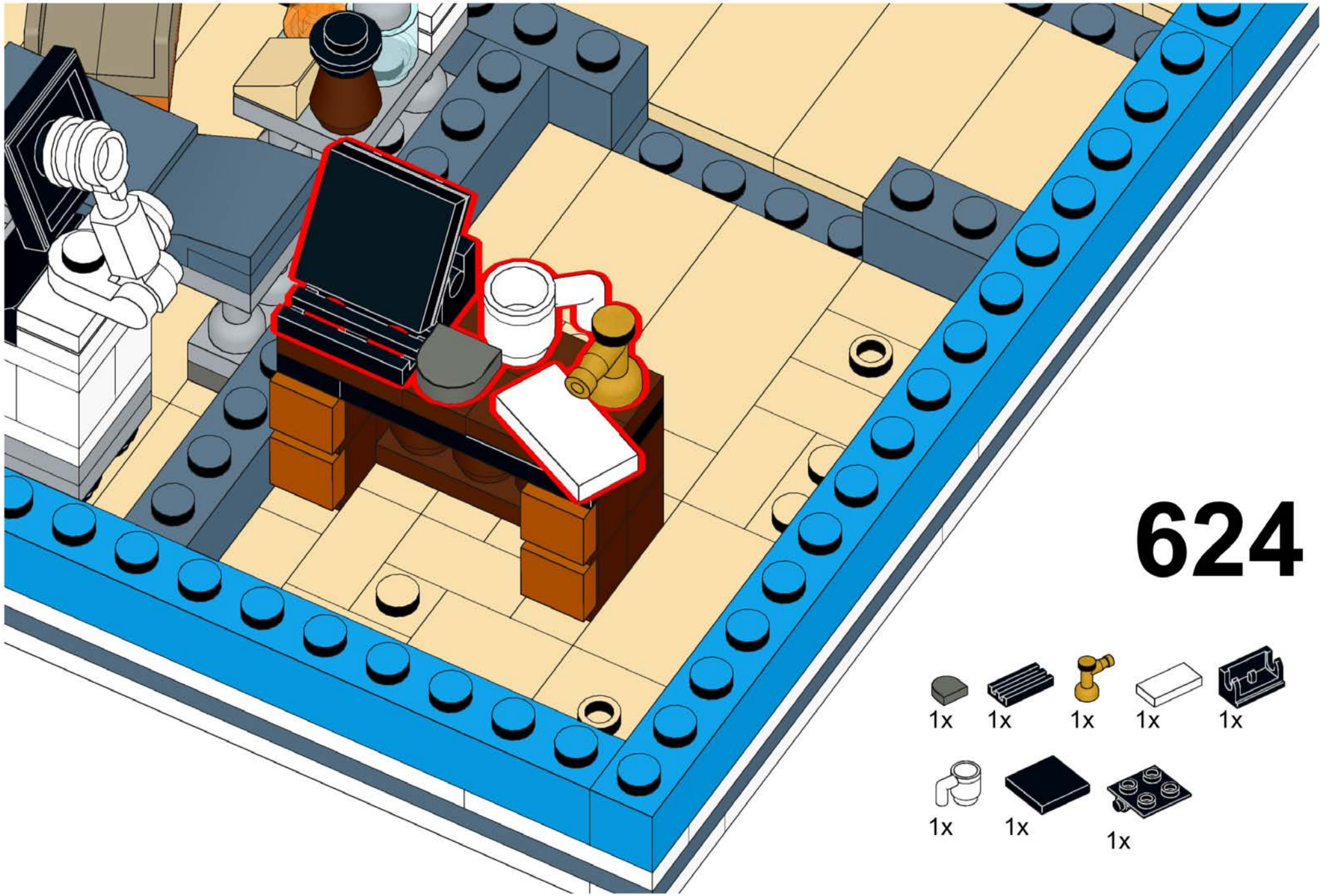







624

- 1x [Grey 1x2 Technic Brick]
- 1x [Black 1x2 Technic Brick]
- 1x [Yellow Technic Pin]
- 1x [White 1x2 Technic Brick]
- 1x [Black 1x2 Technic Brick]
- 1x [White Mug]
- 1x [Black 1x2 Technic Brick]
- 1x [Black 2x2 Technic Plate]



# 625



- 1x  1x  1x 
- 1x  1x 
- 1x  1x 

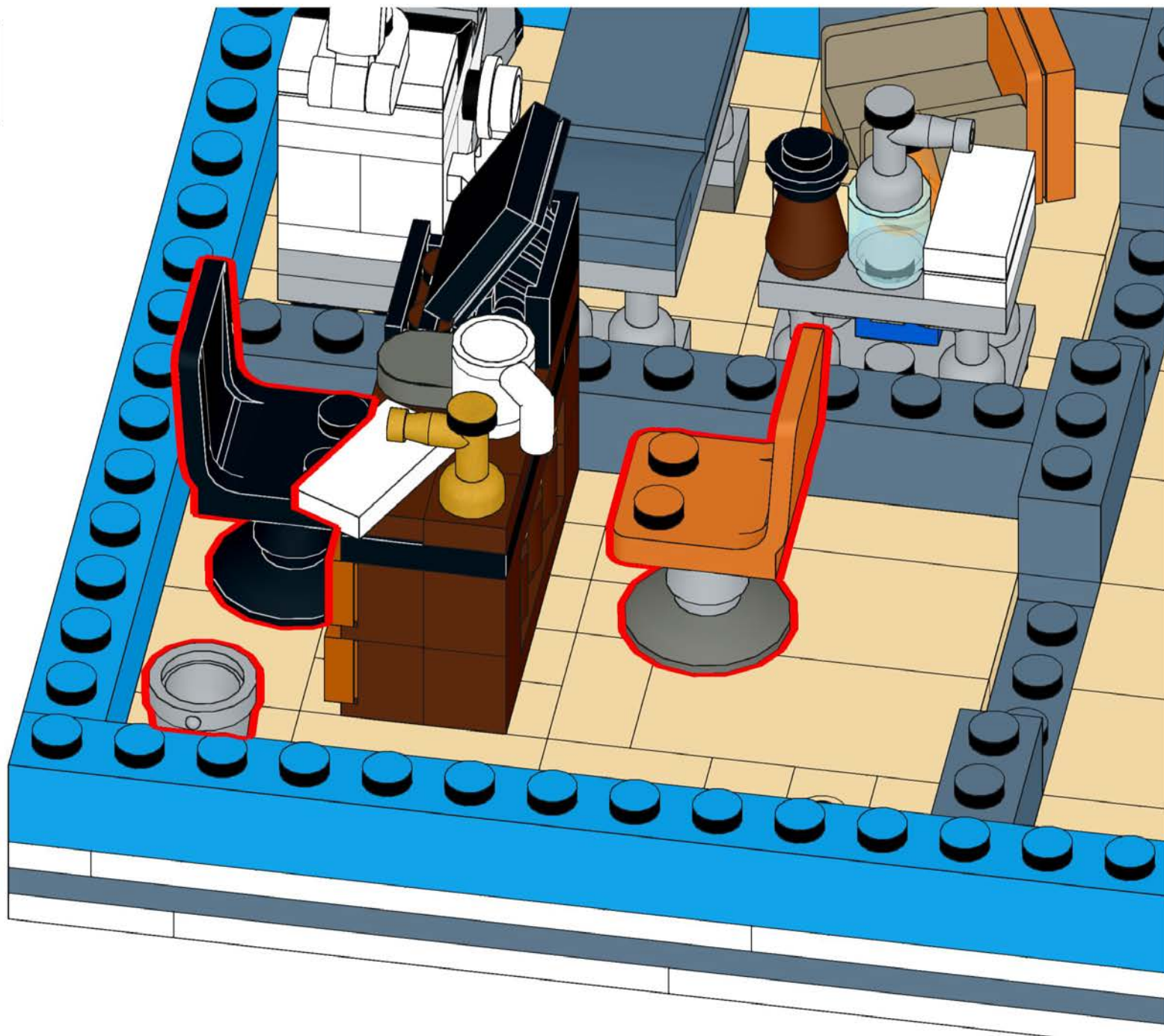

# 626

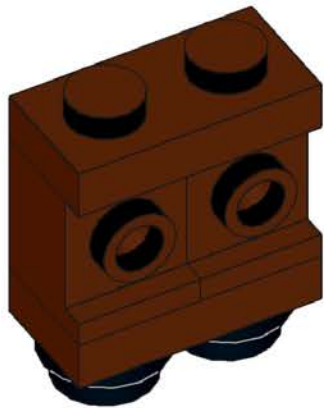
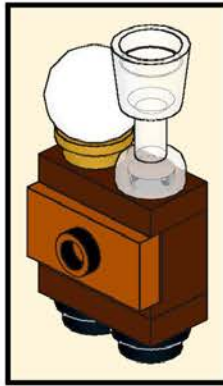

# 627

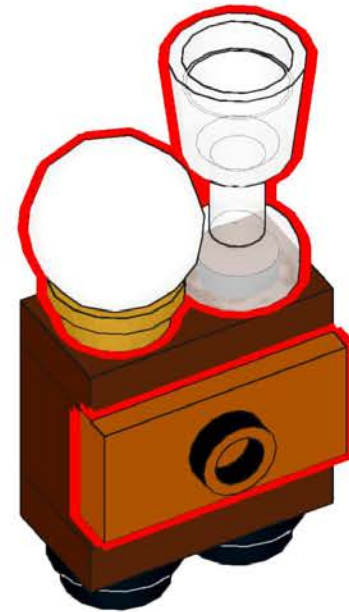
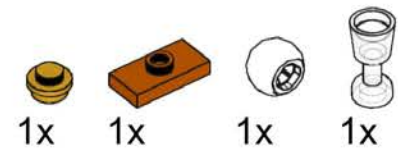

628

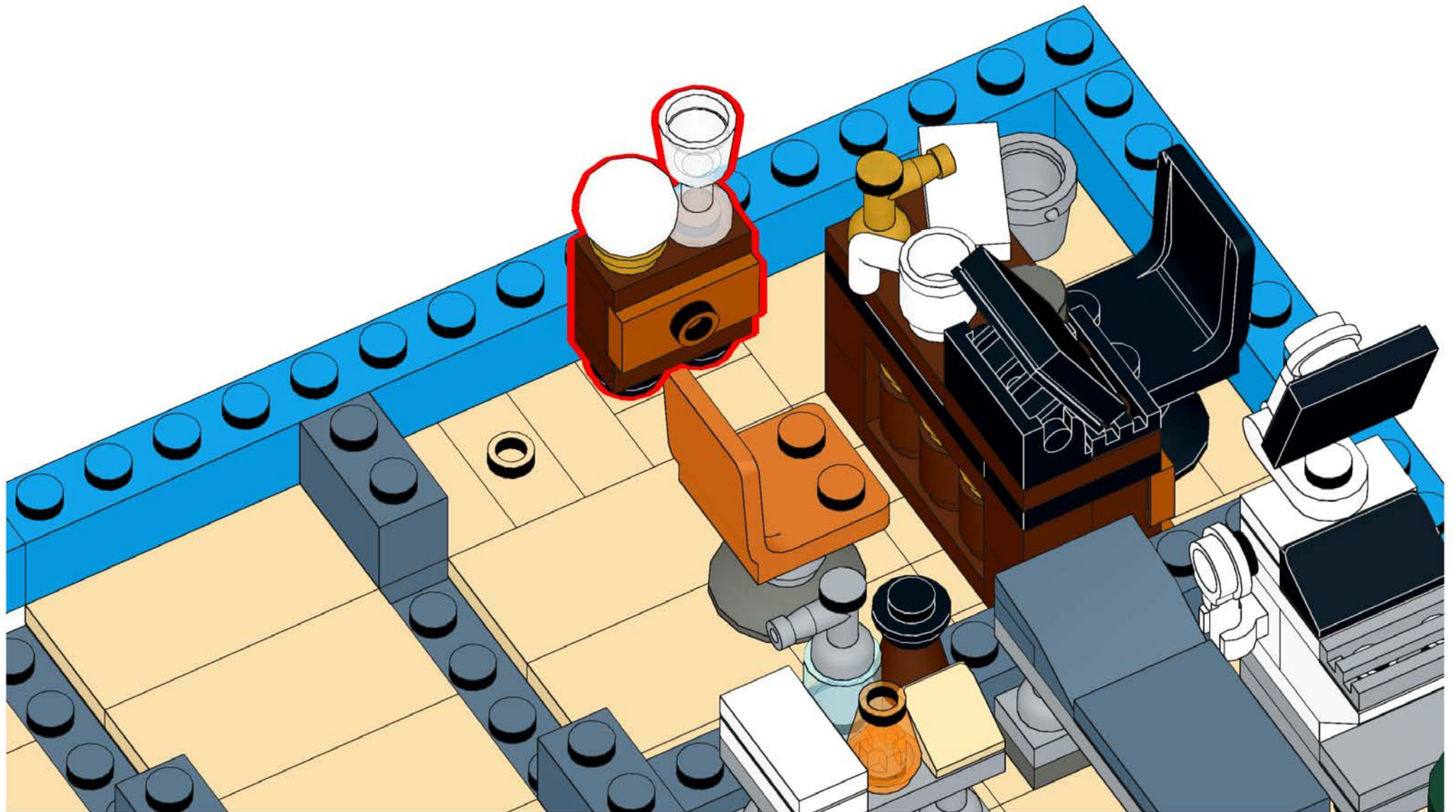

# 629

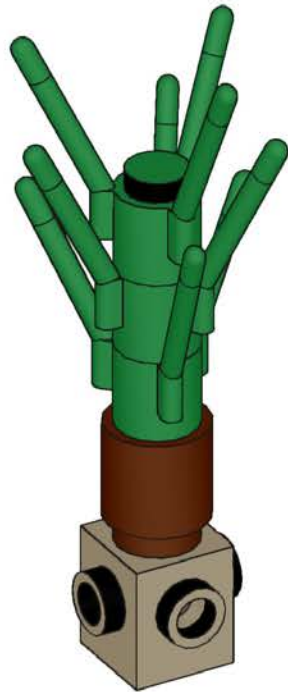
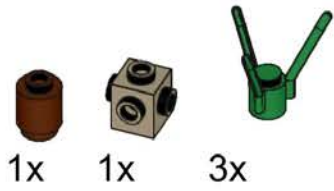

# 630

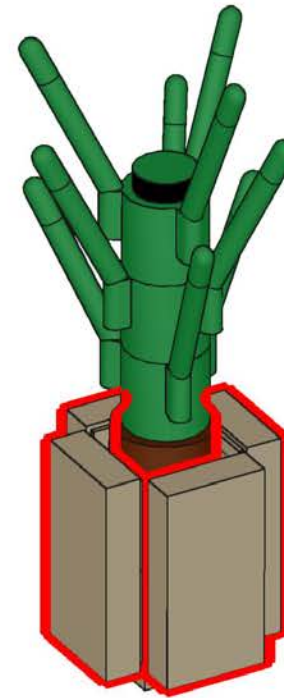
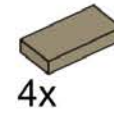

# 631



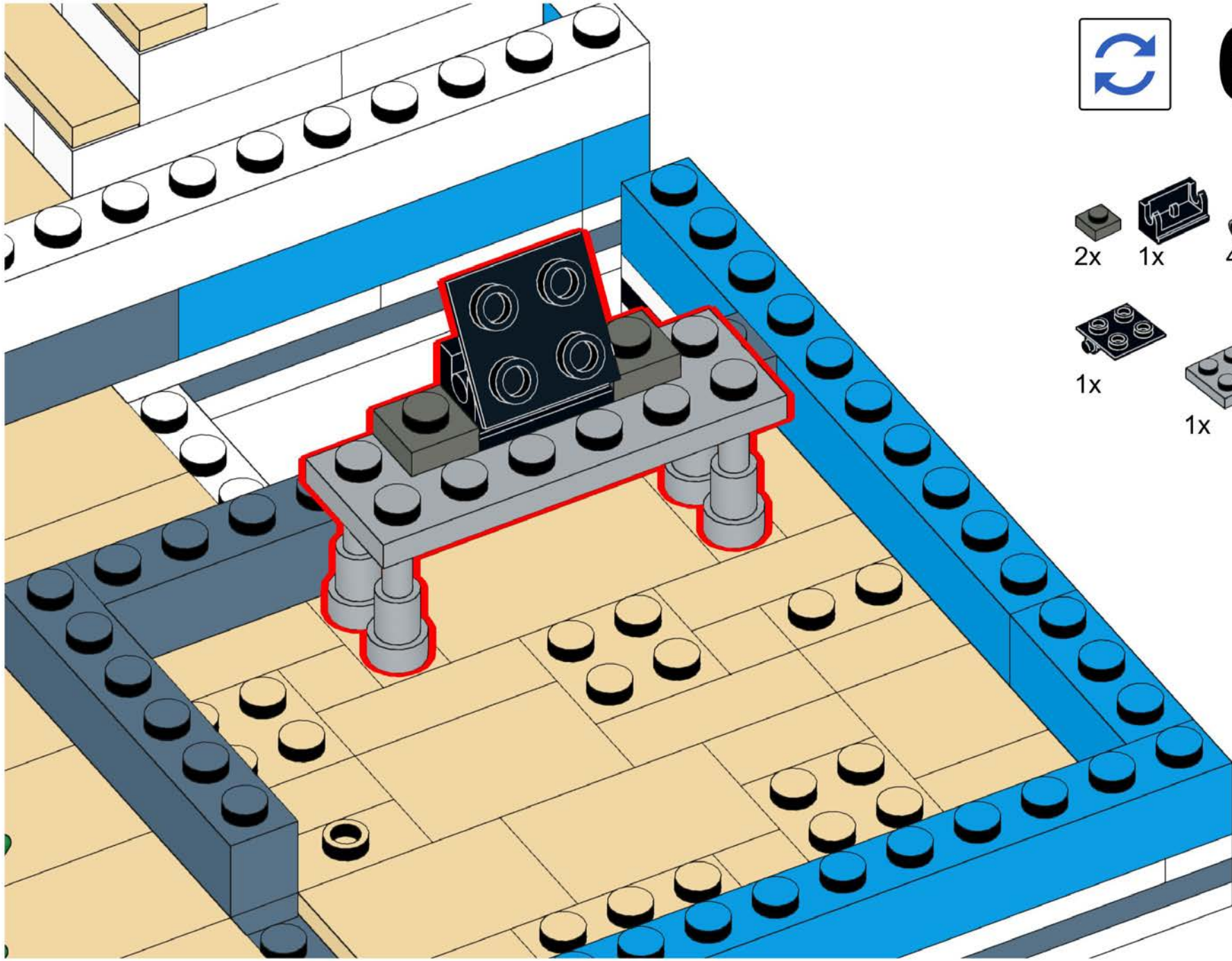

# 632

- 2x
- 1x
- 4x

- 1x
- 1x

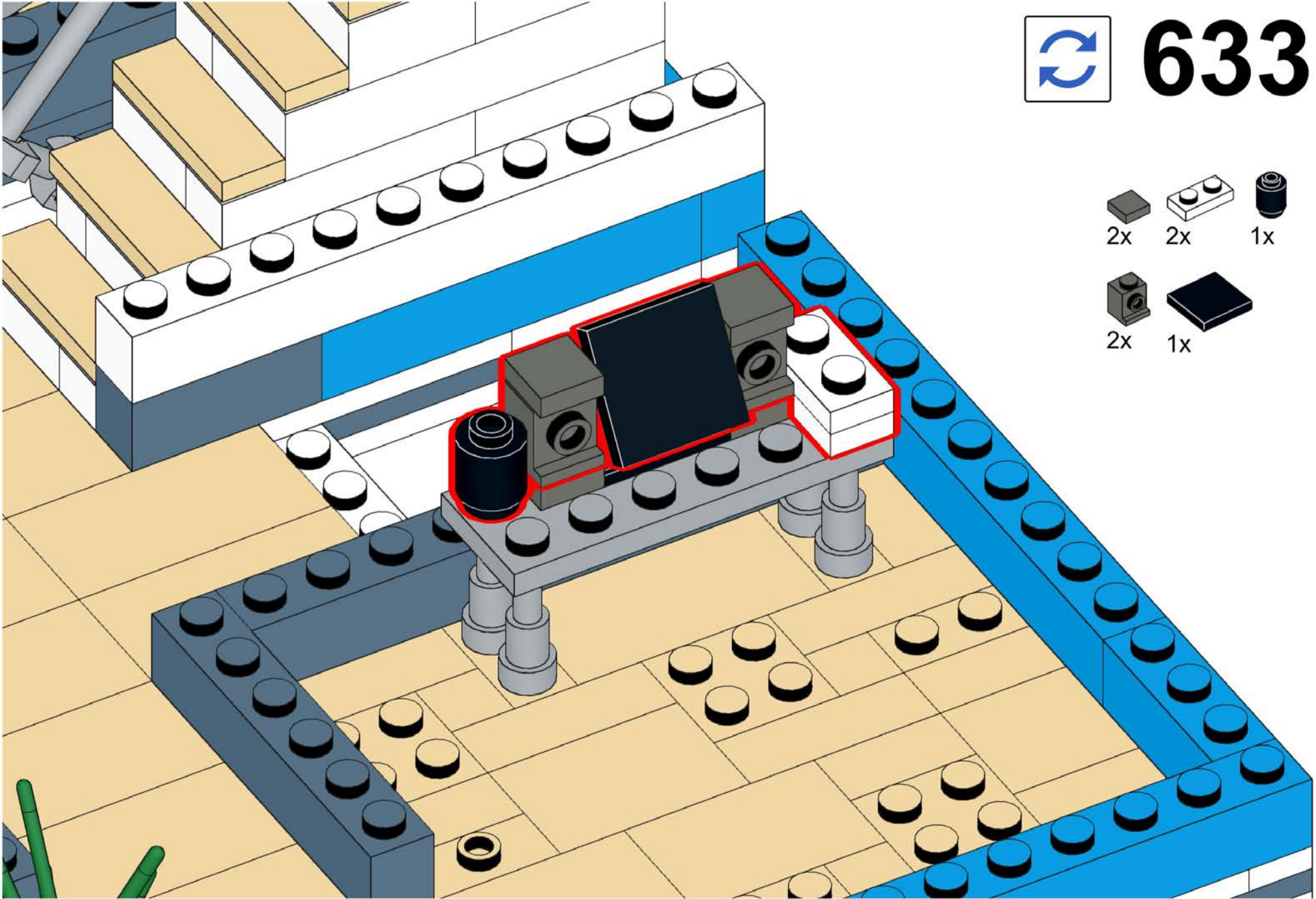

# 633

- 2x
- 2x
- 1x
- 2x
- 1x

# 634

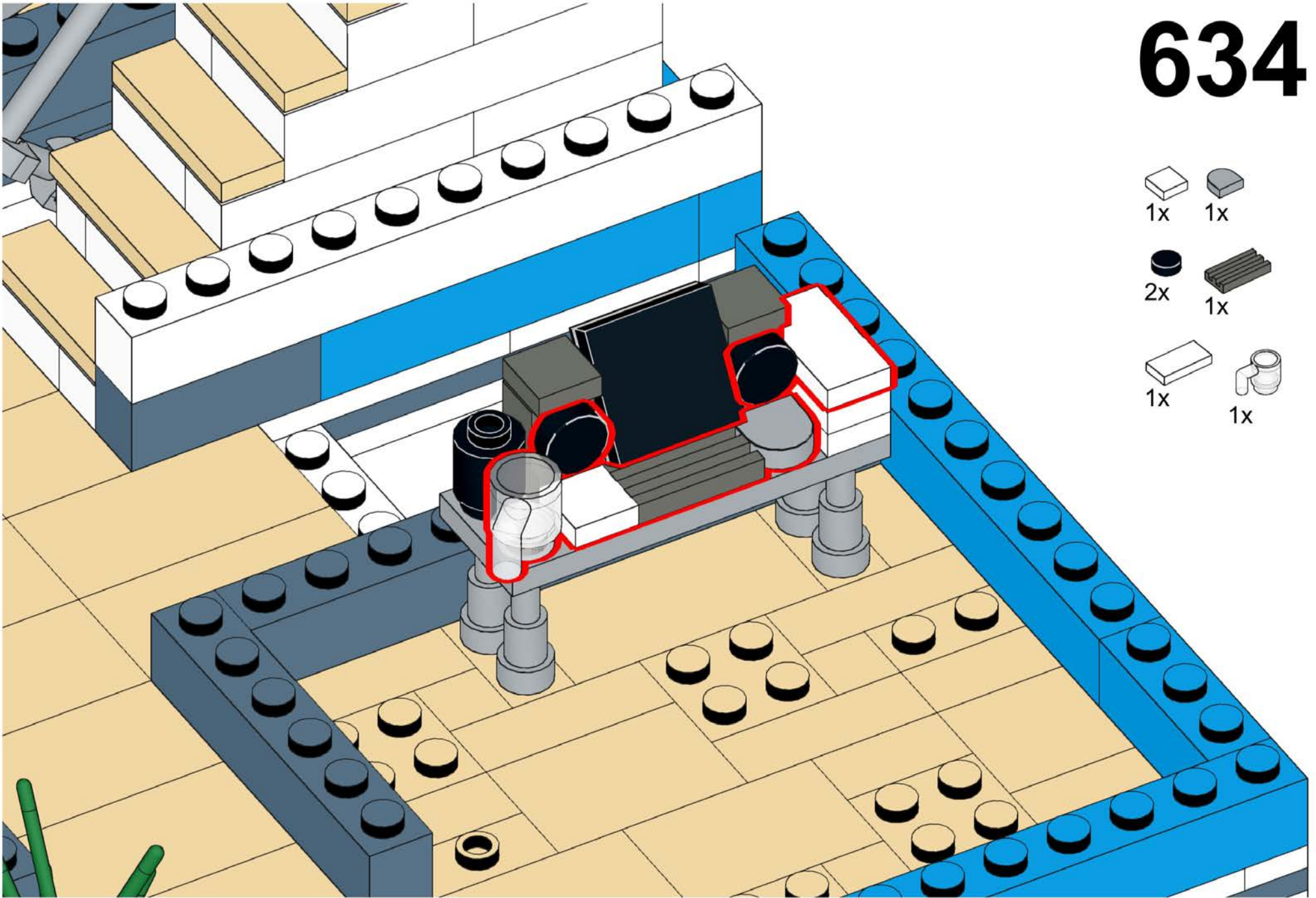





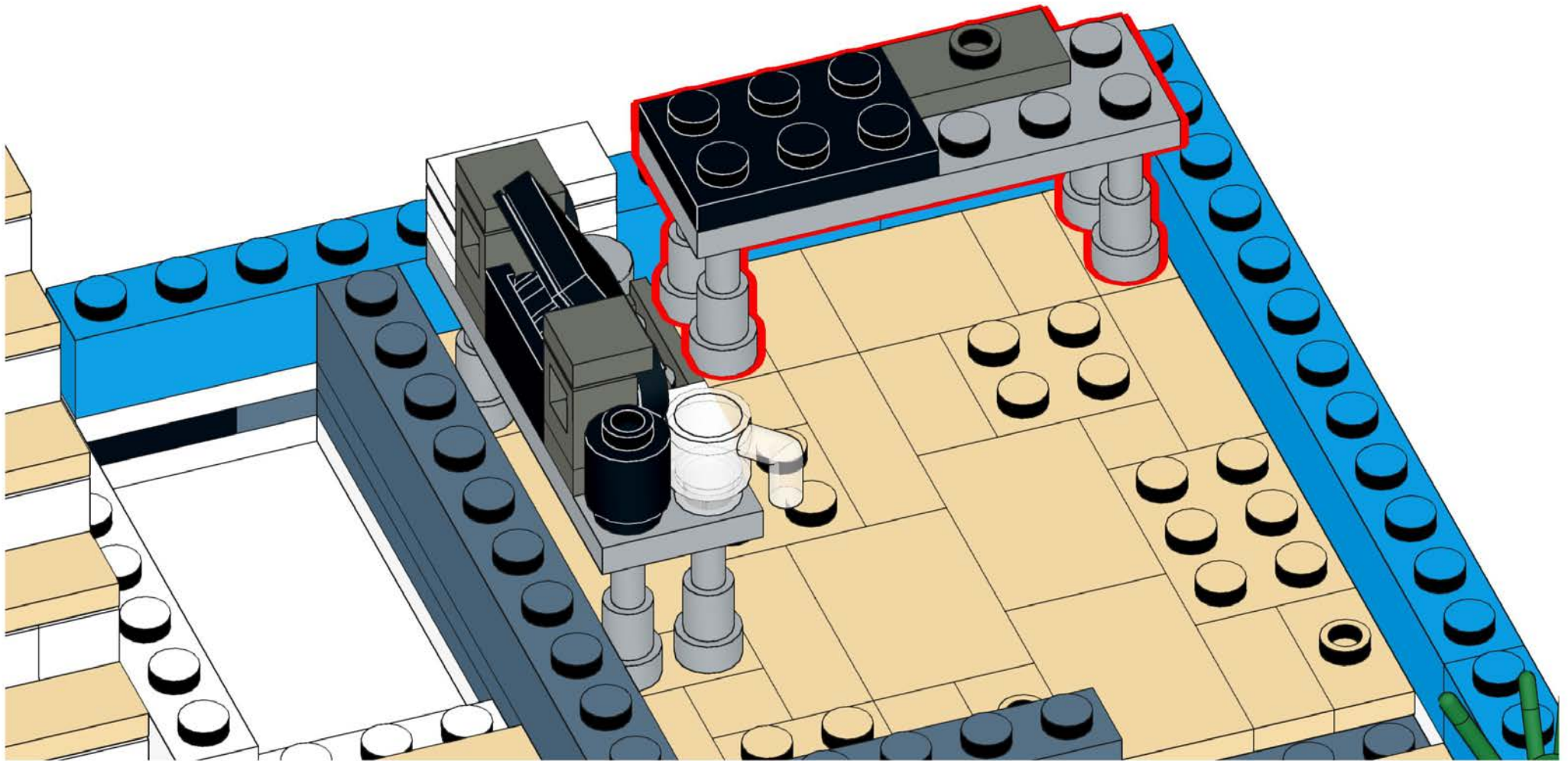
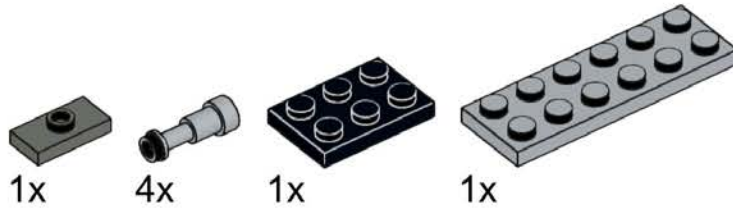



# 635





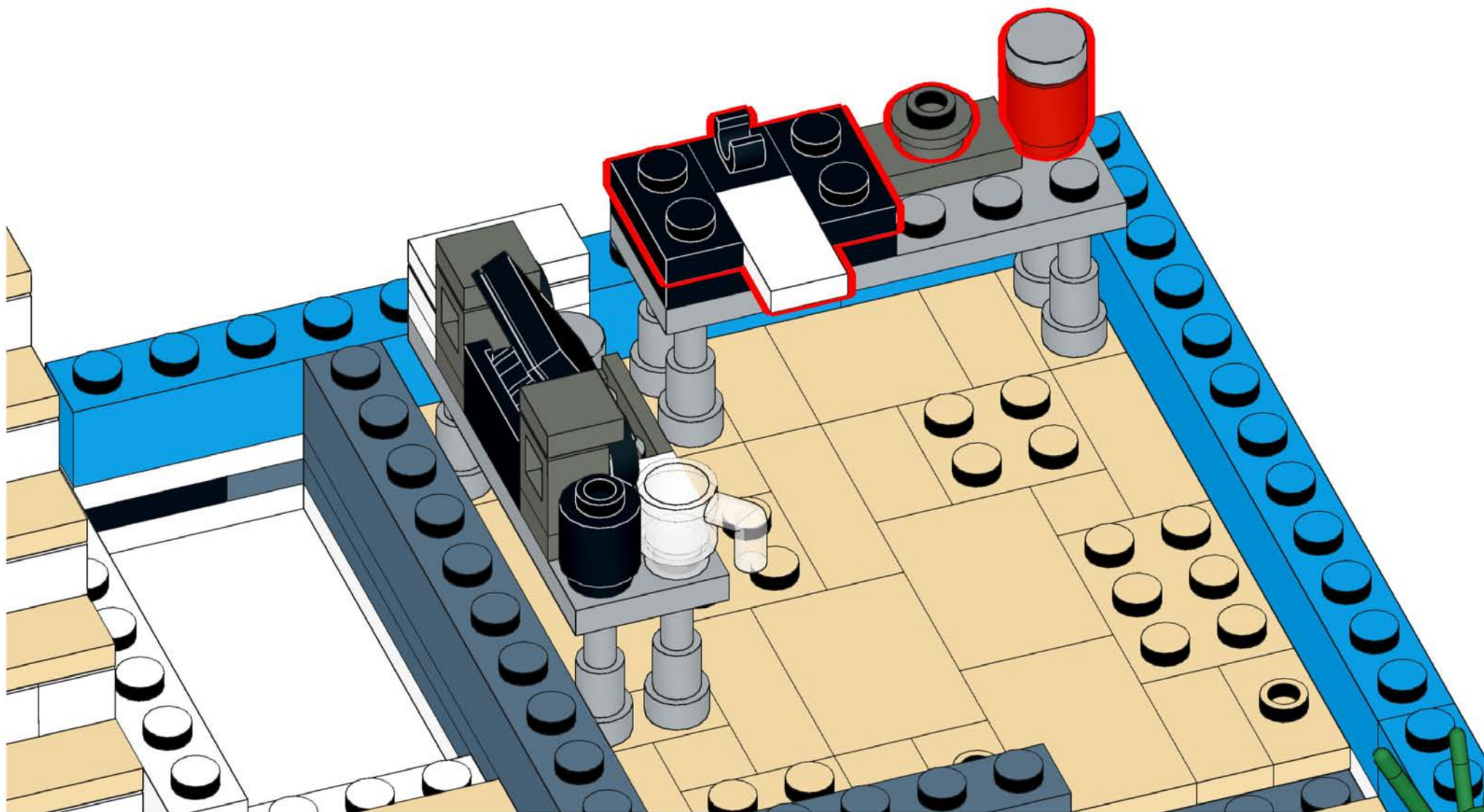

# 636

- 1x 
- 1x 
- 1x 
- 1x 
- 2x 
- 1x 



# 637

- 1x 
- 4x 
- 1x 
- 1x 
- 1x 
- 1x 

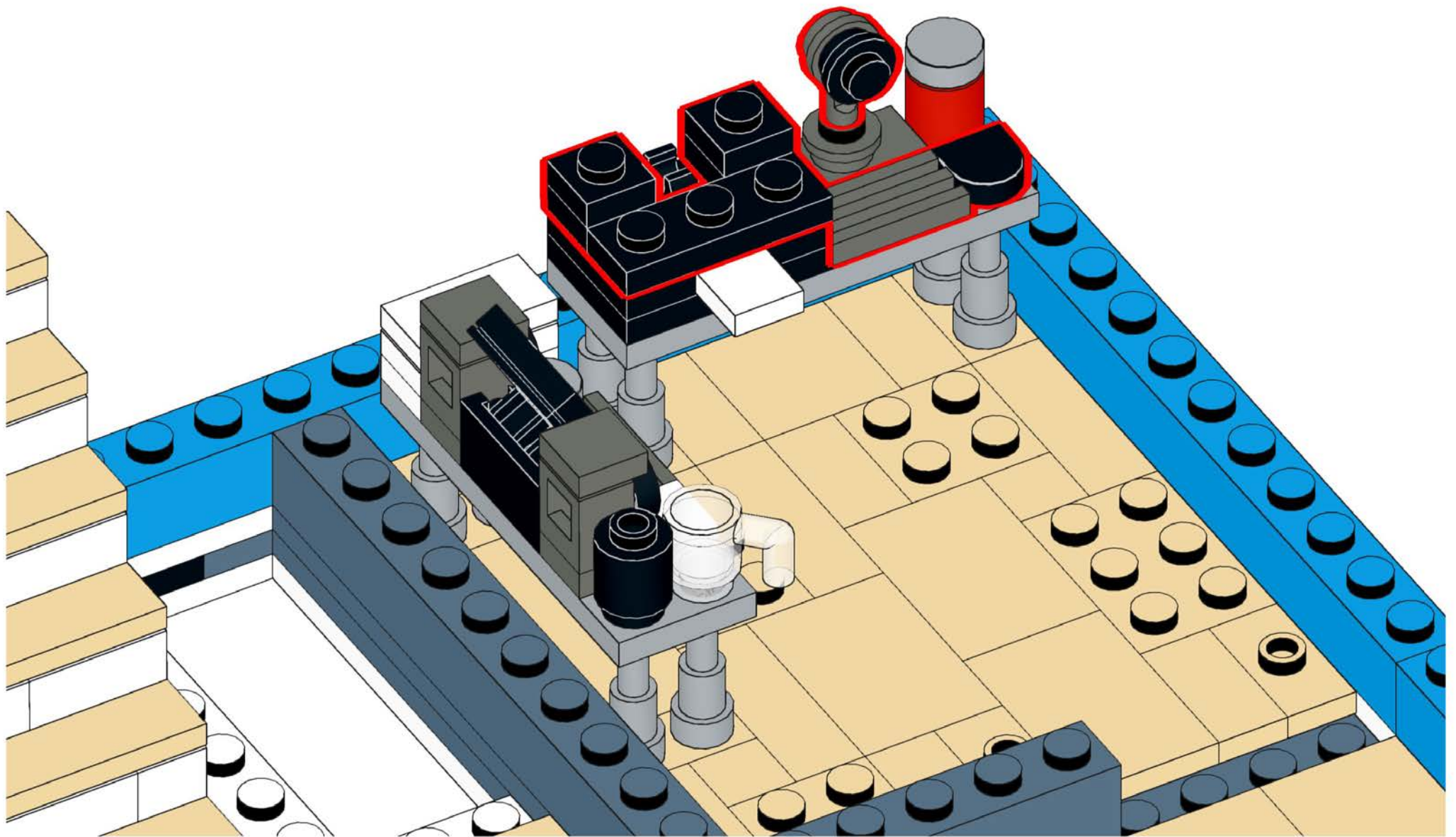

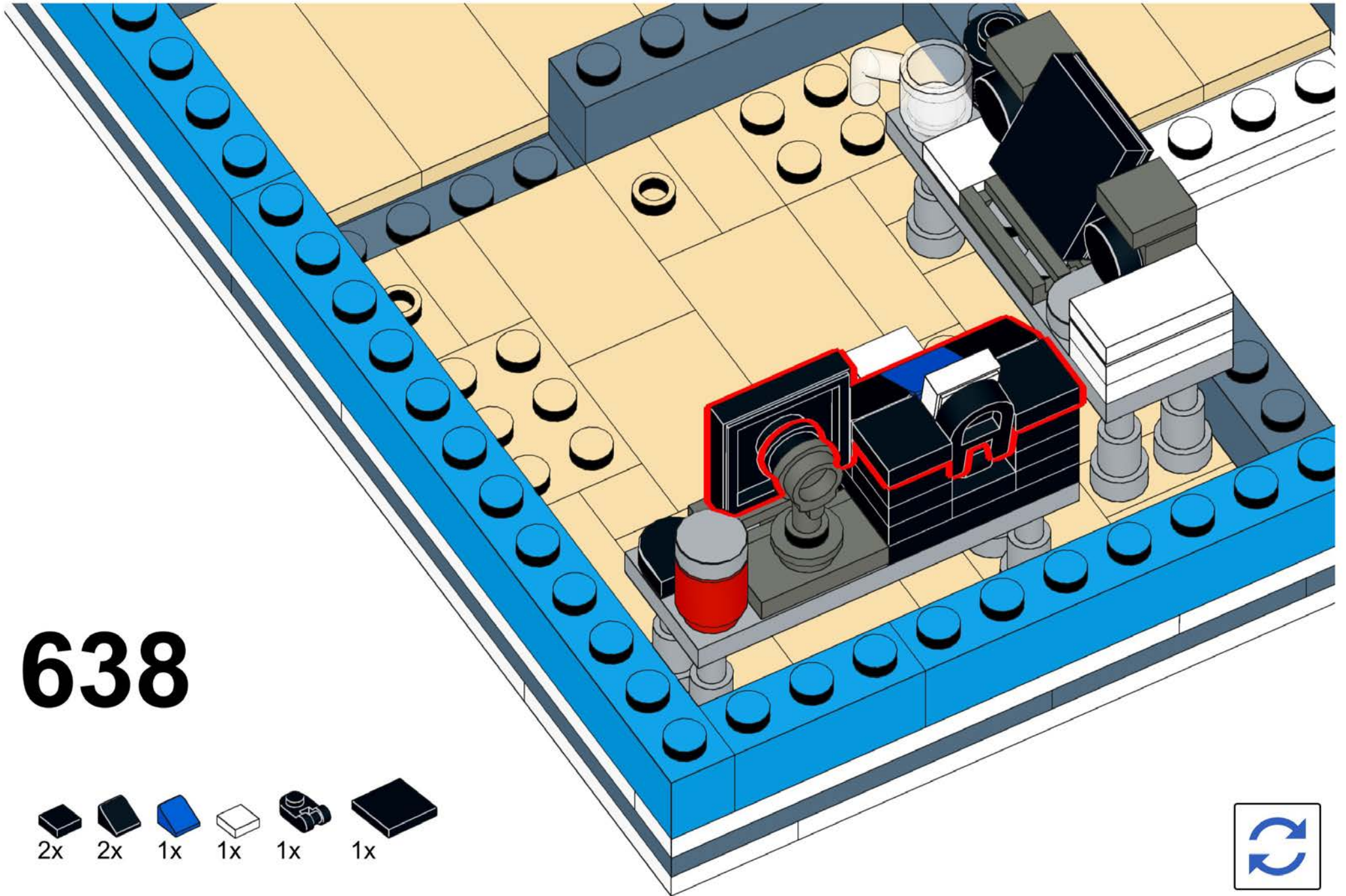

638

- 2x
- 2x
- 1x
- 1x
- 1x
- 1x



# 639

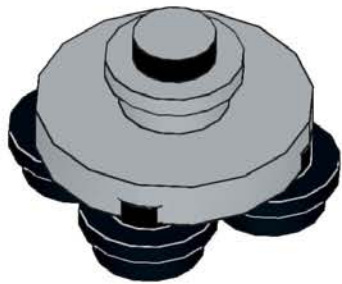
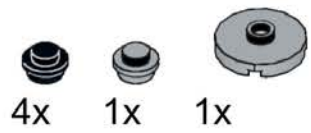

2x

# 640

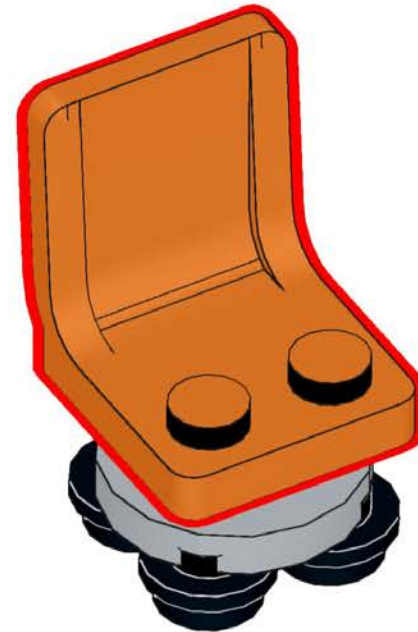

# 641

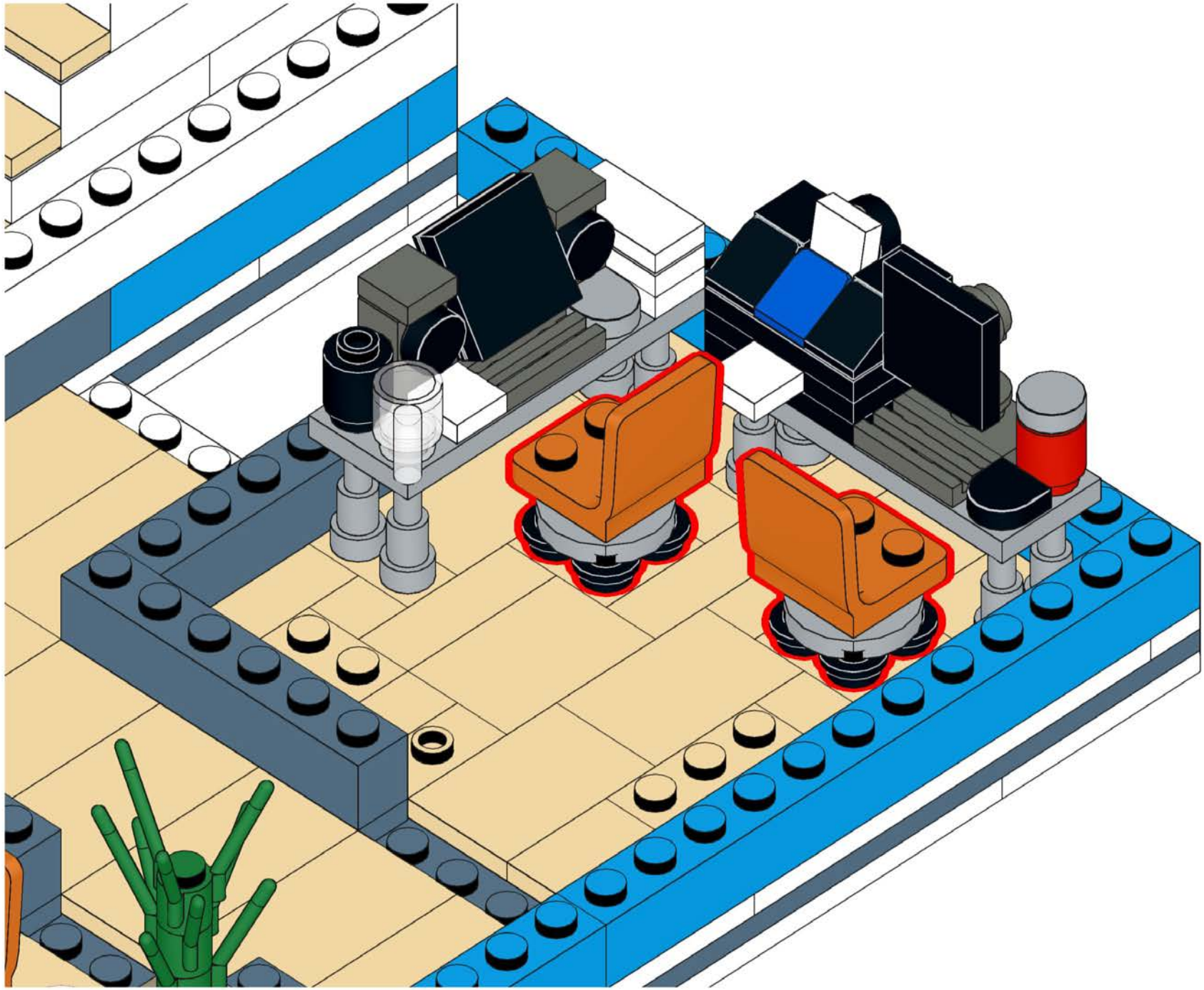



# 642

- 1x
- 1x
- 1x
- 1x
- 1x
- 1x
- 1x
- 1x

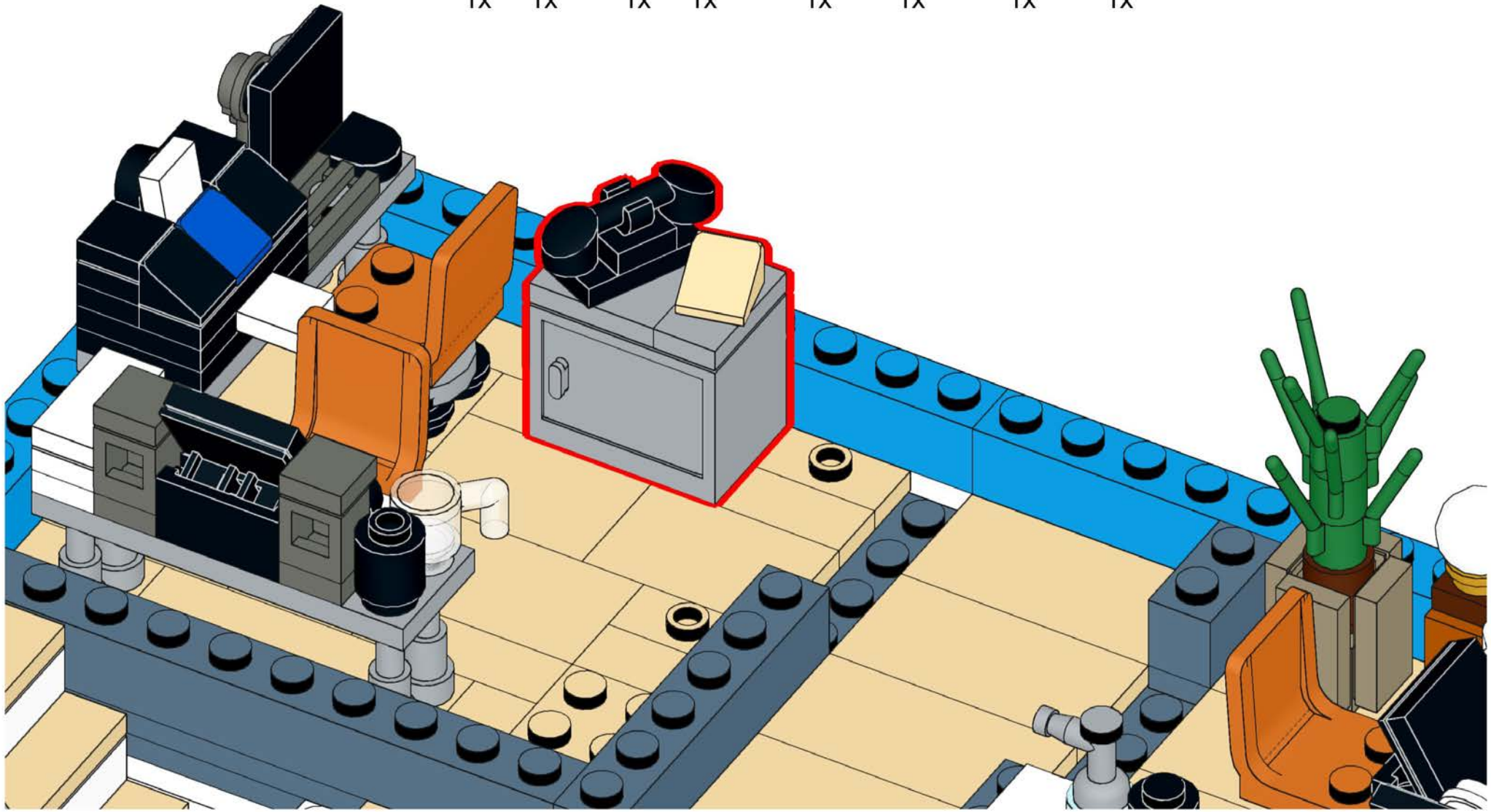

# 643



2x



1x



1x



1x

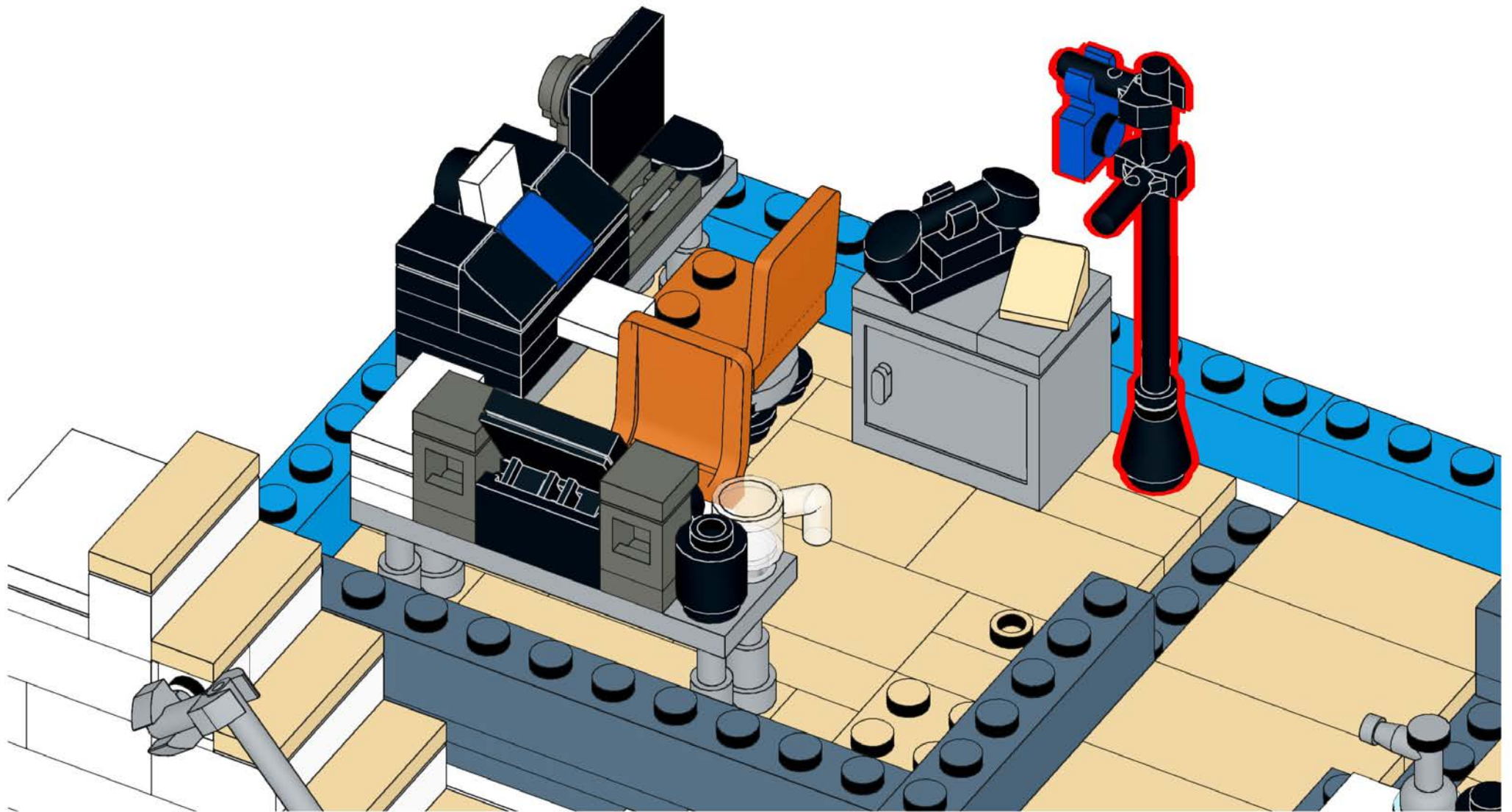



# 644

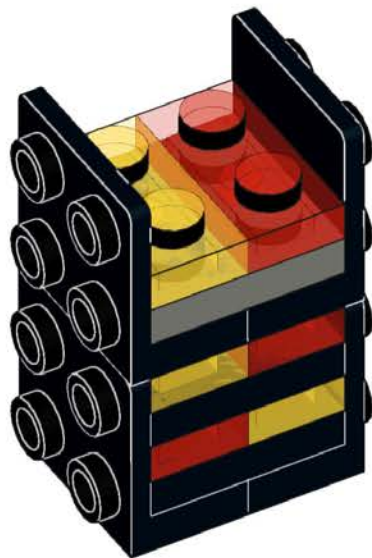
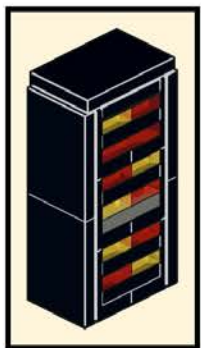
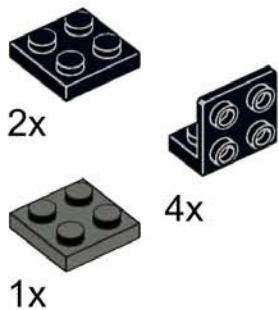
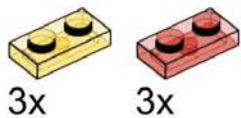

# 645

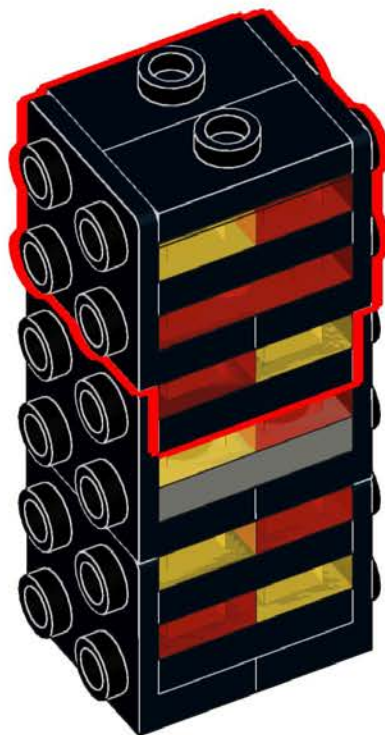
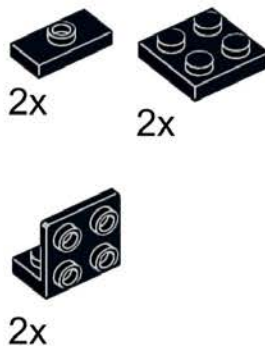
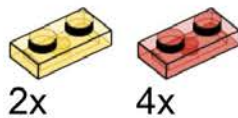

# 646

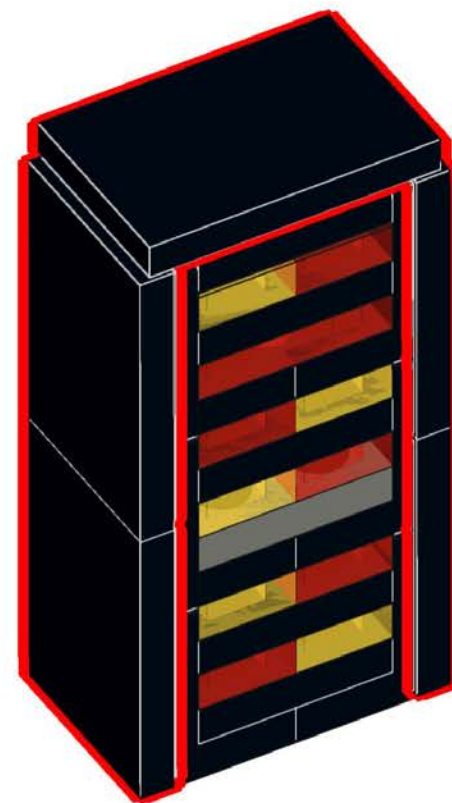
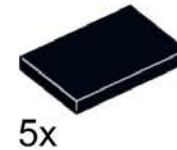

647

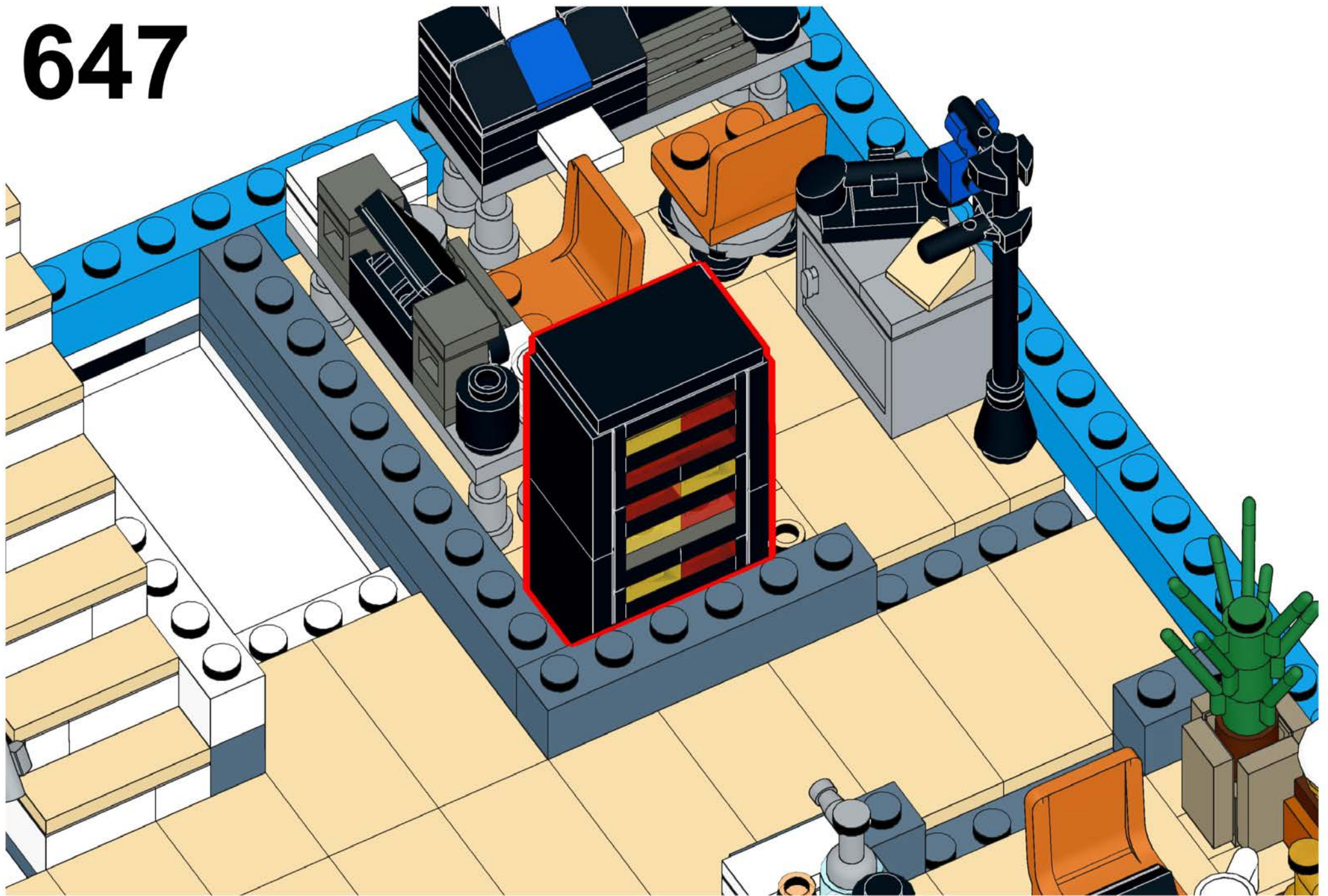

# 648



1x



1x



3x

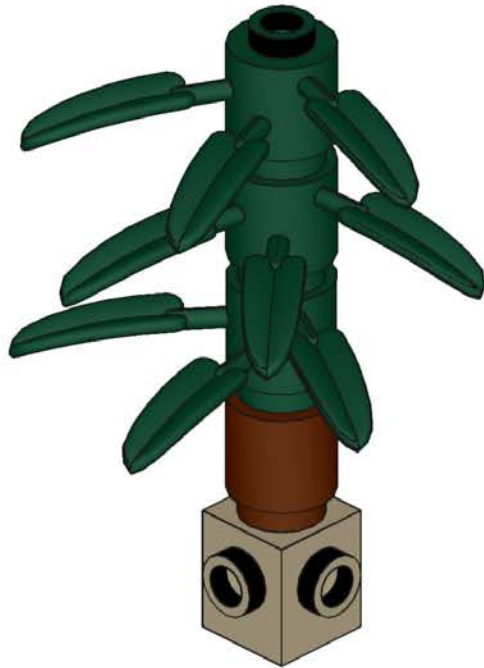
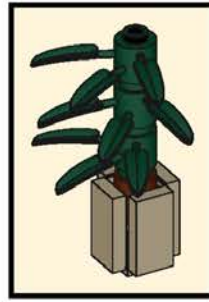

# 649



4x

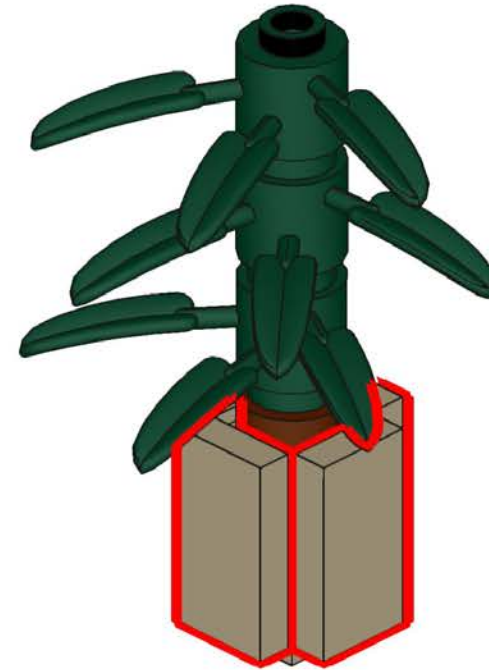

# 650

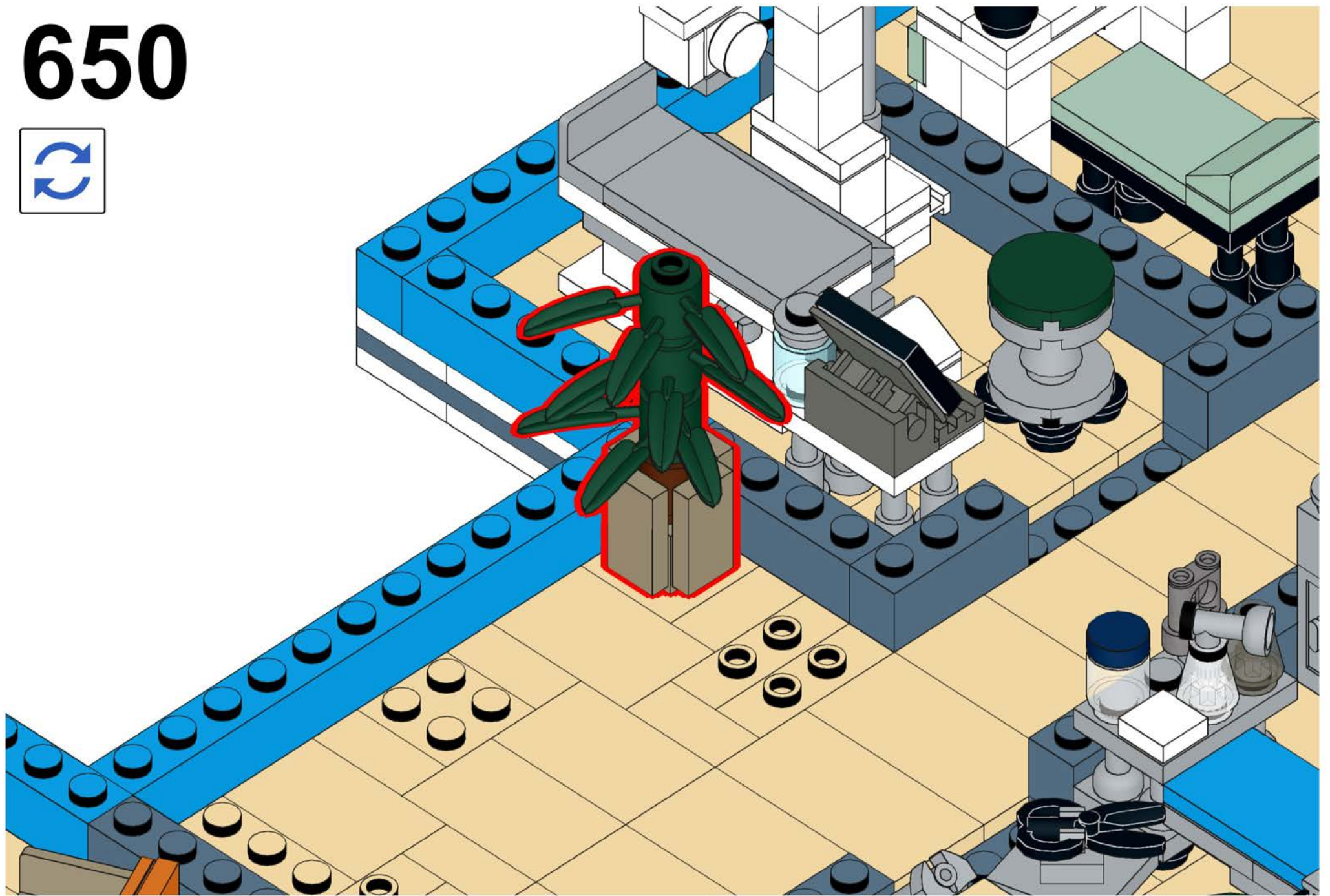

# 651



1x



1x



1x

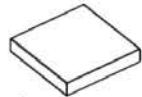

1x

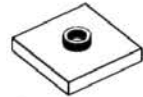

1x

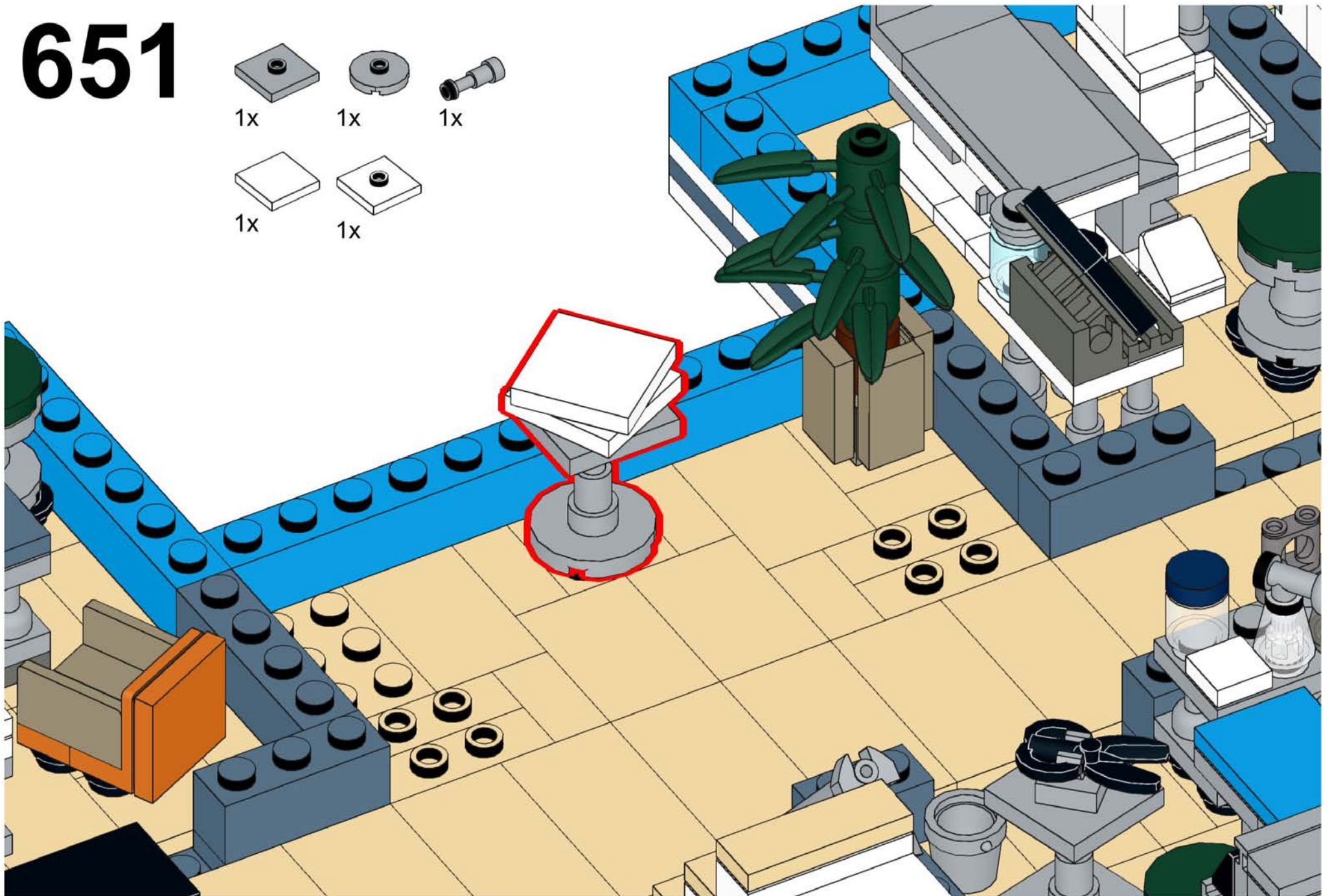

# 652

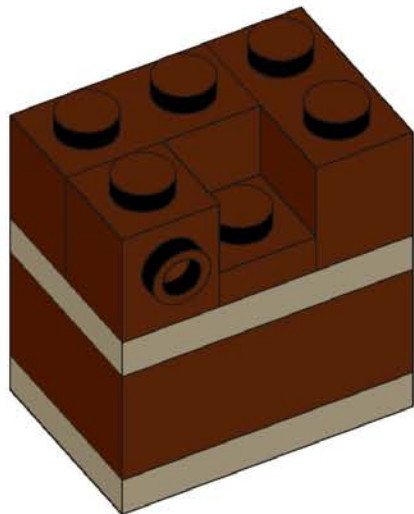
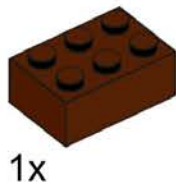
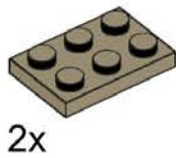
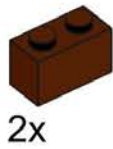
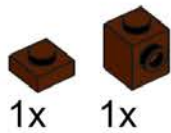
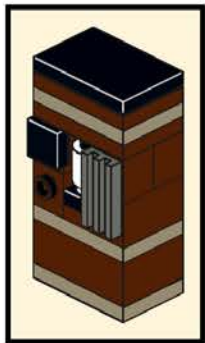

# 653

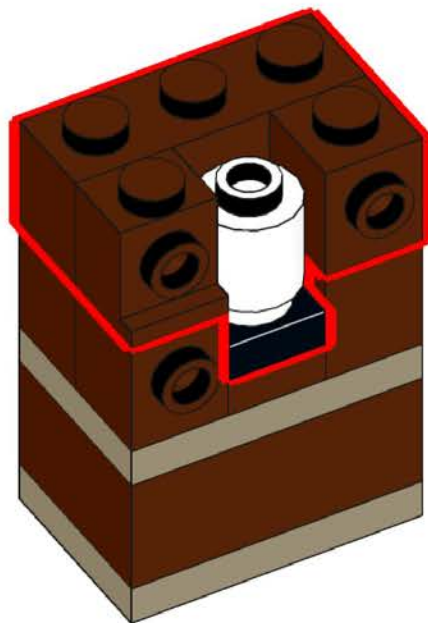
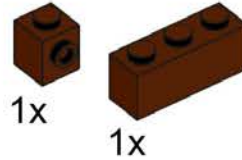
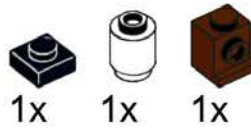

# 654

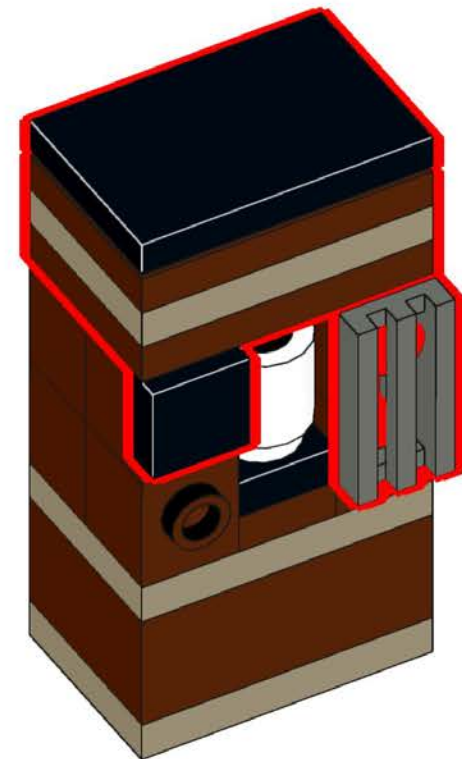
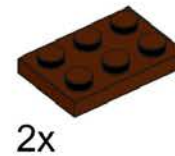

# 655

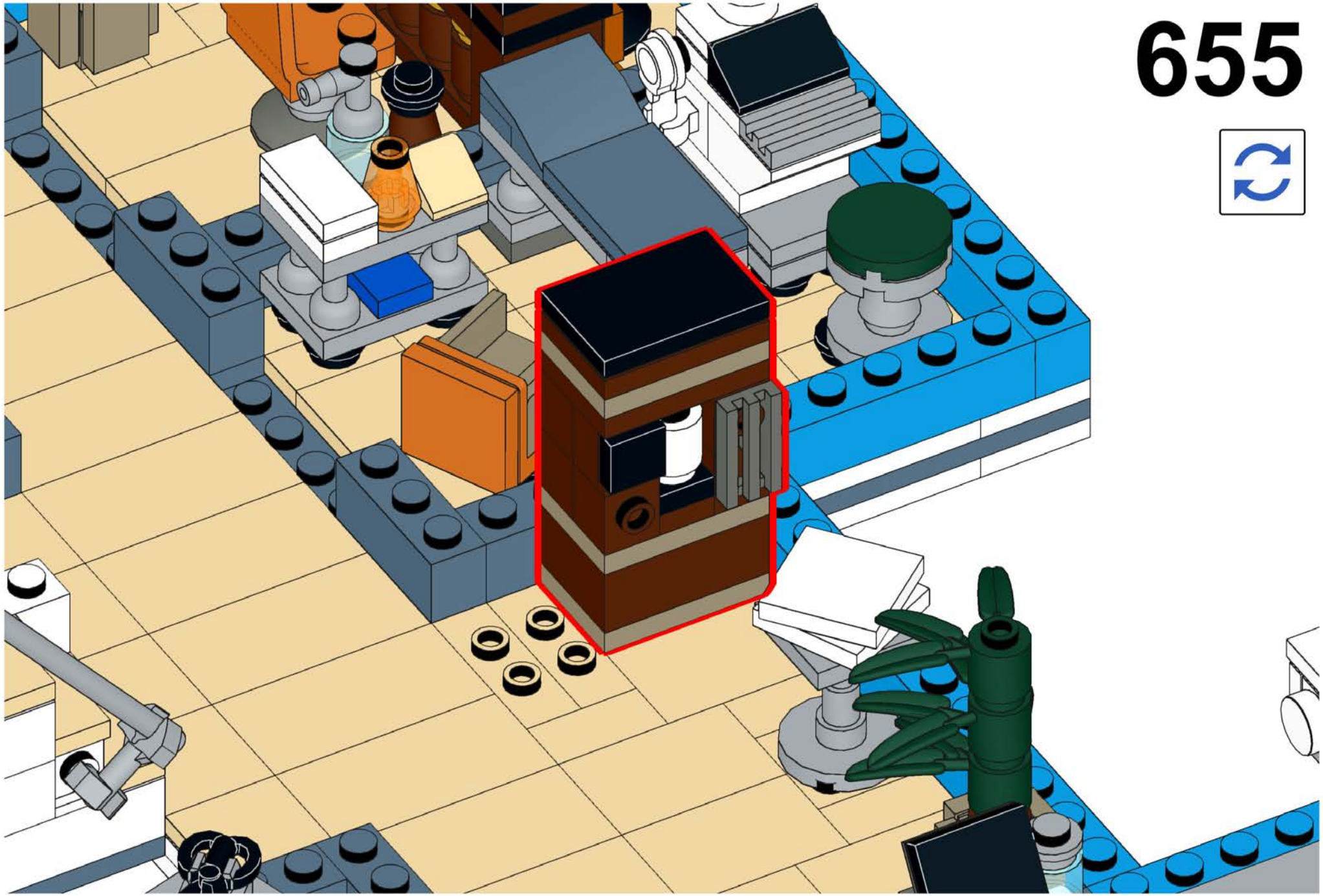

# 656

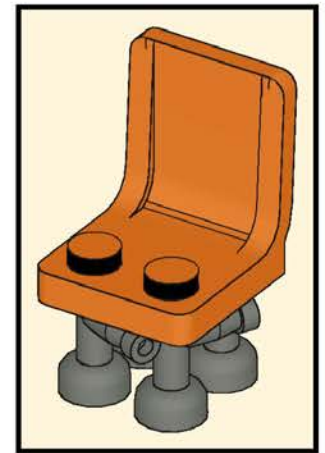
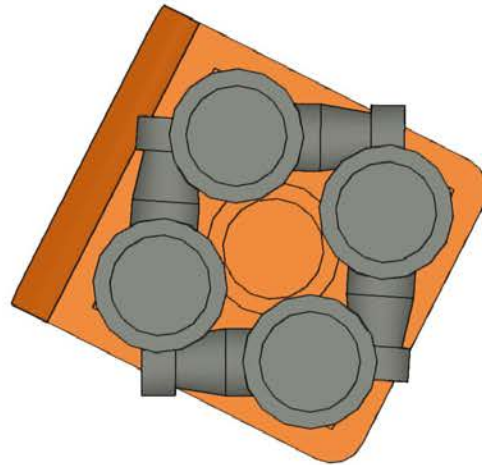
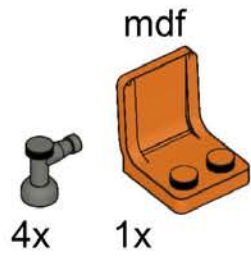

**2x**



657

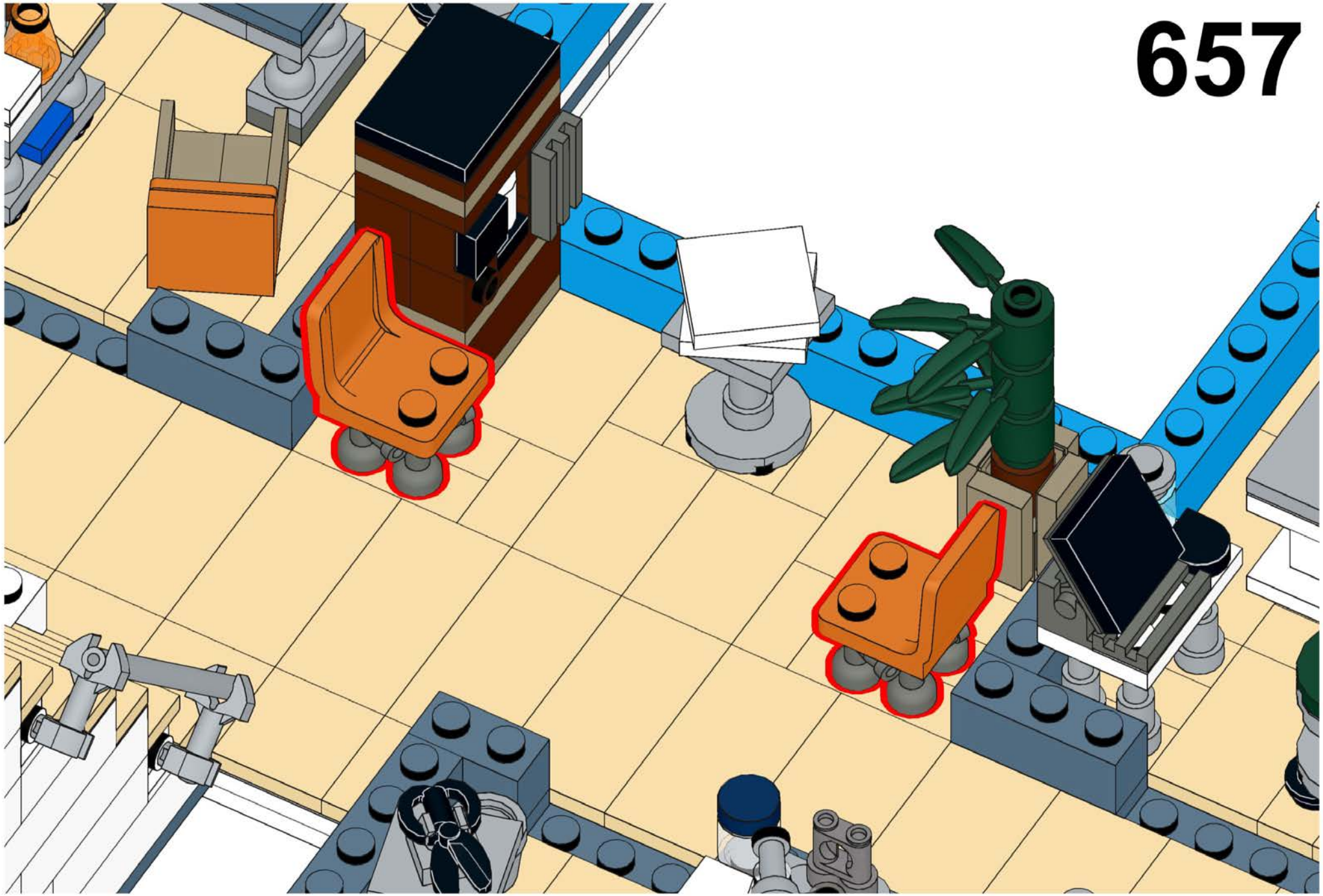

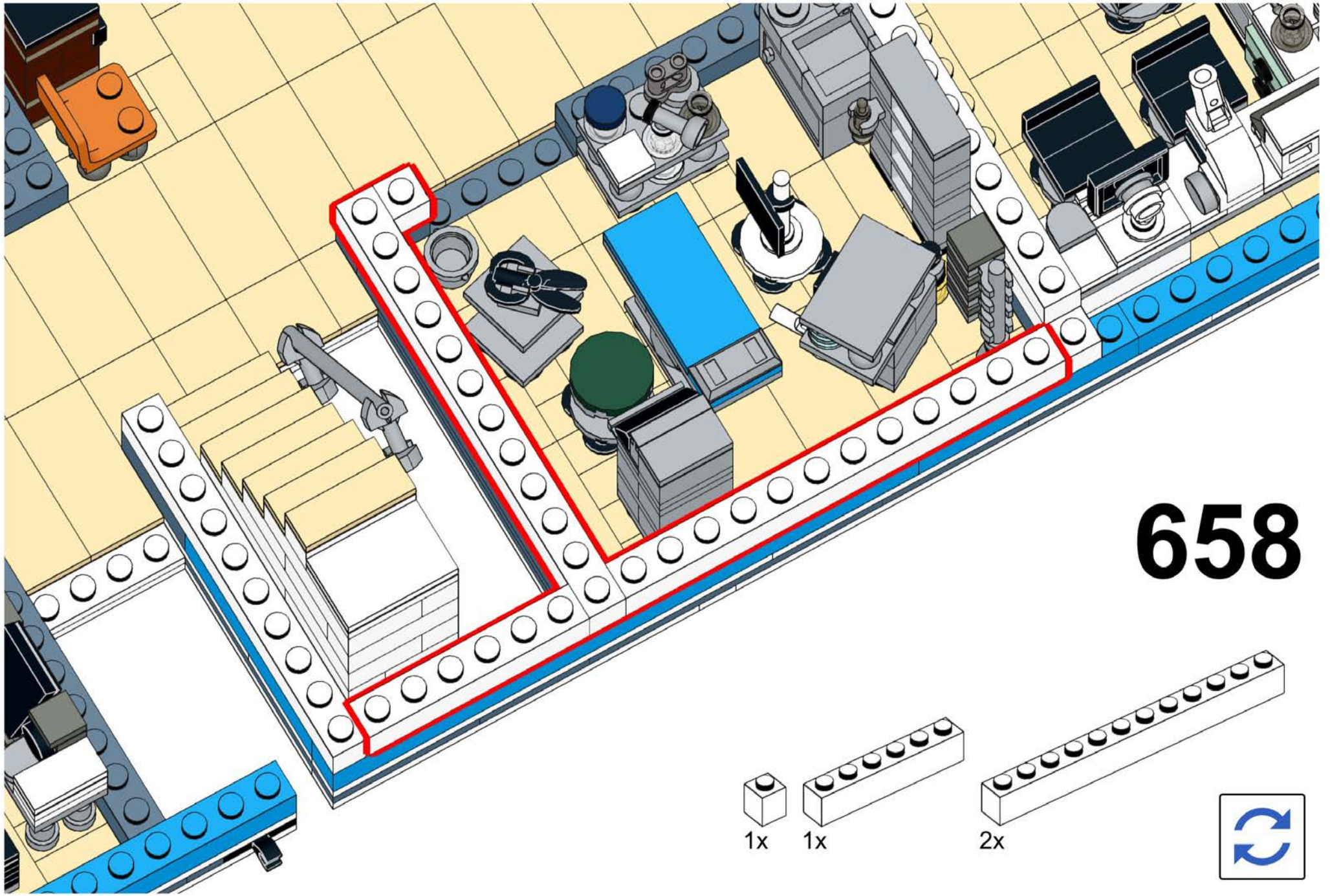

658



1x

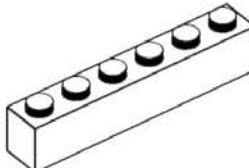

1x

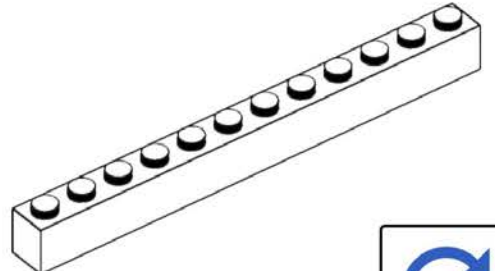

2x



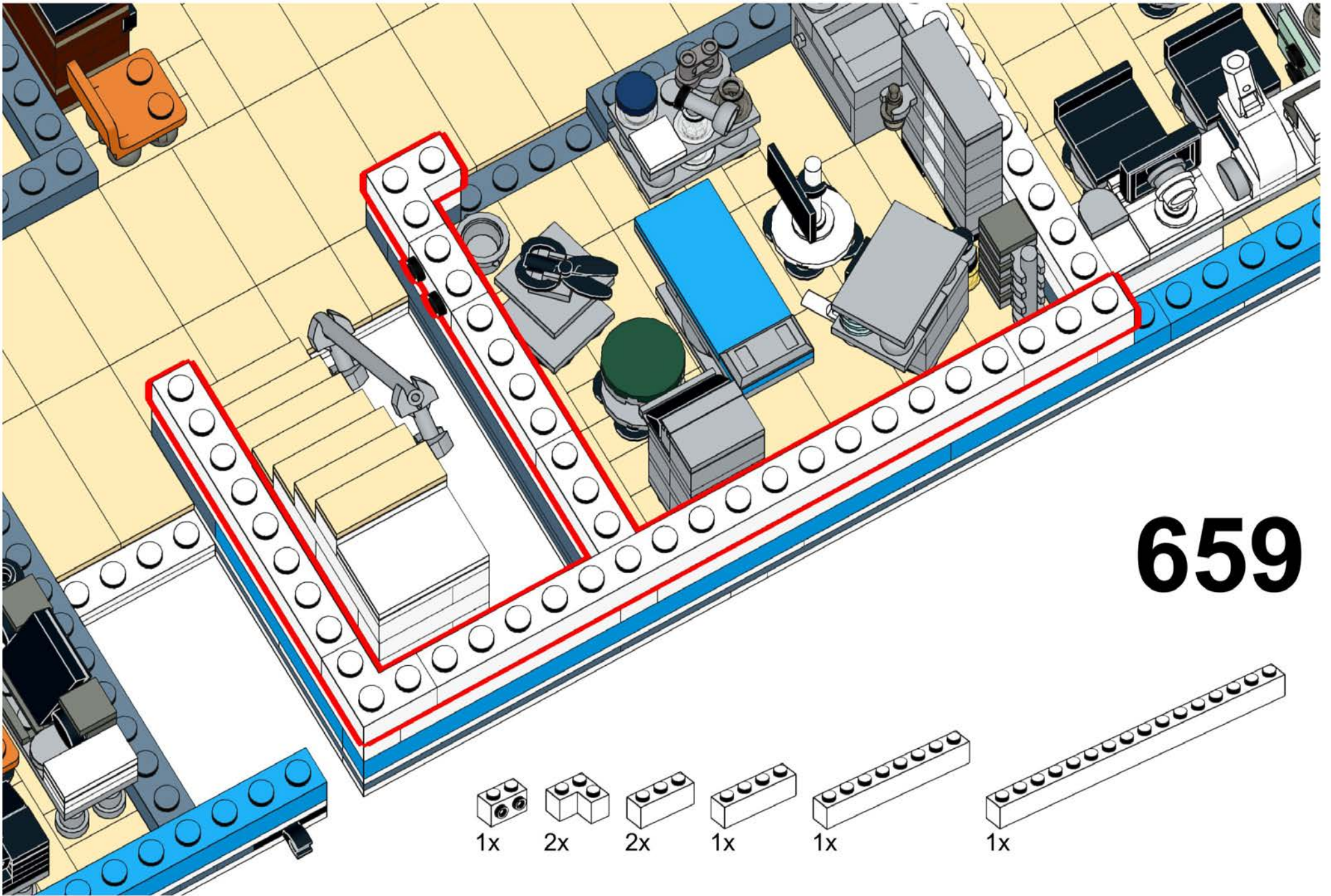

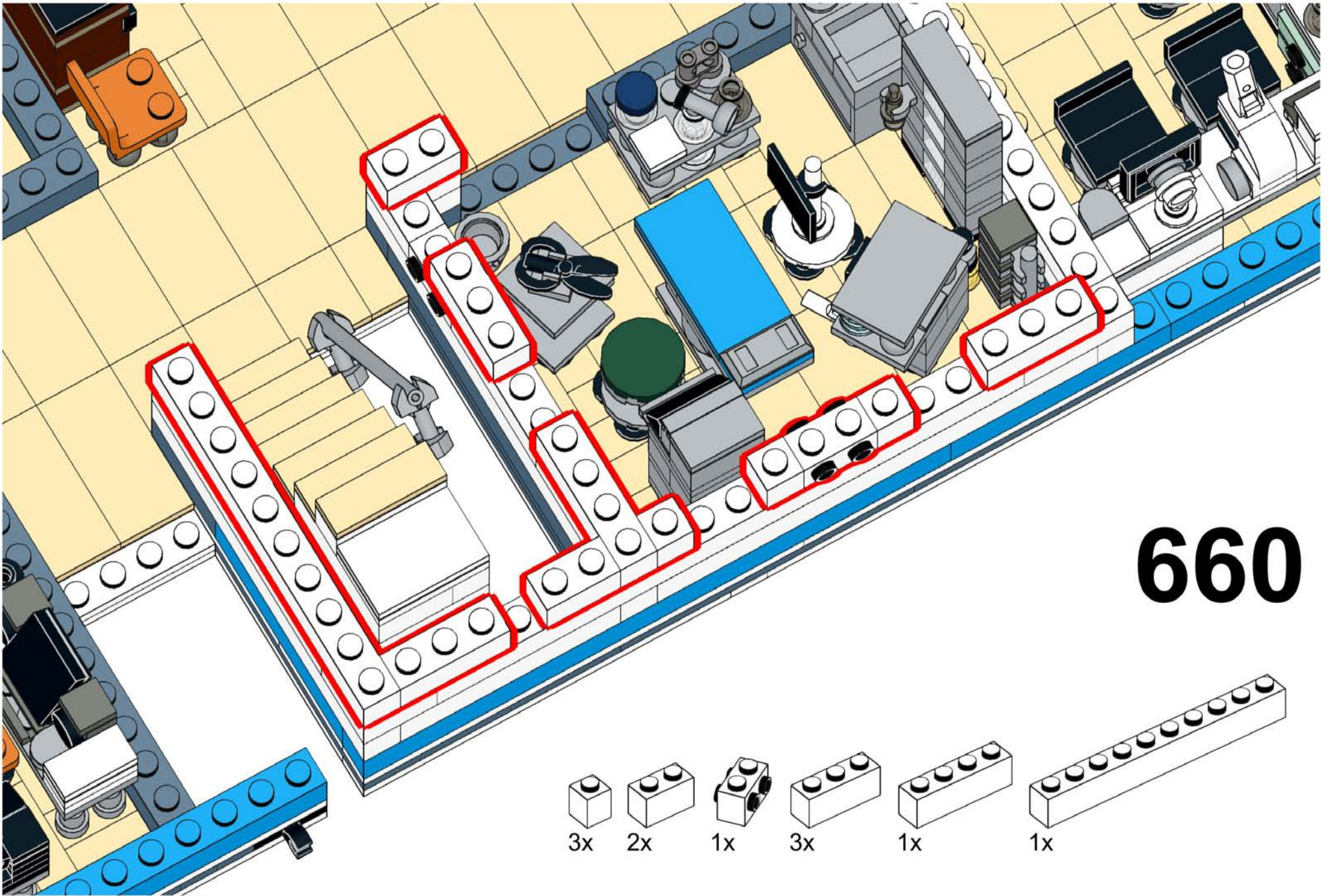

660

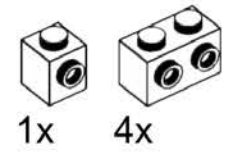
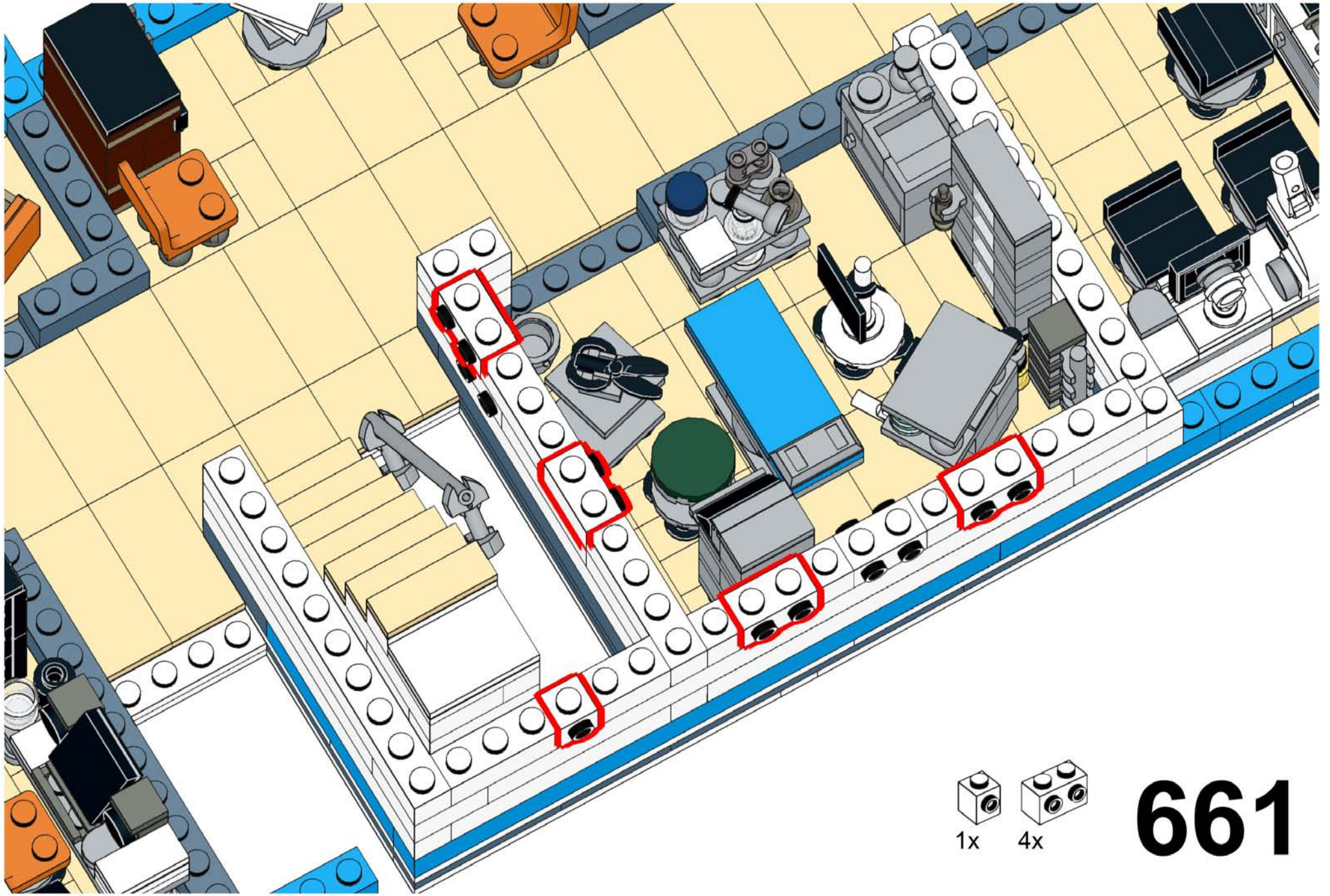

**661**

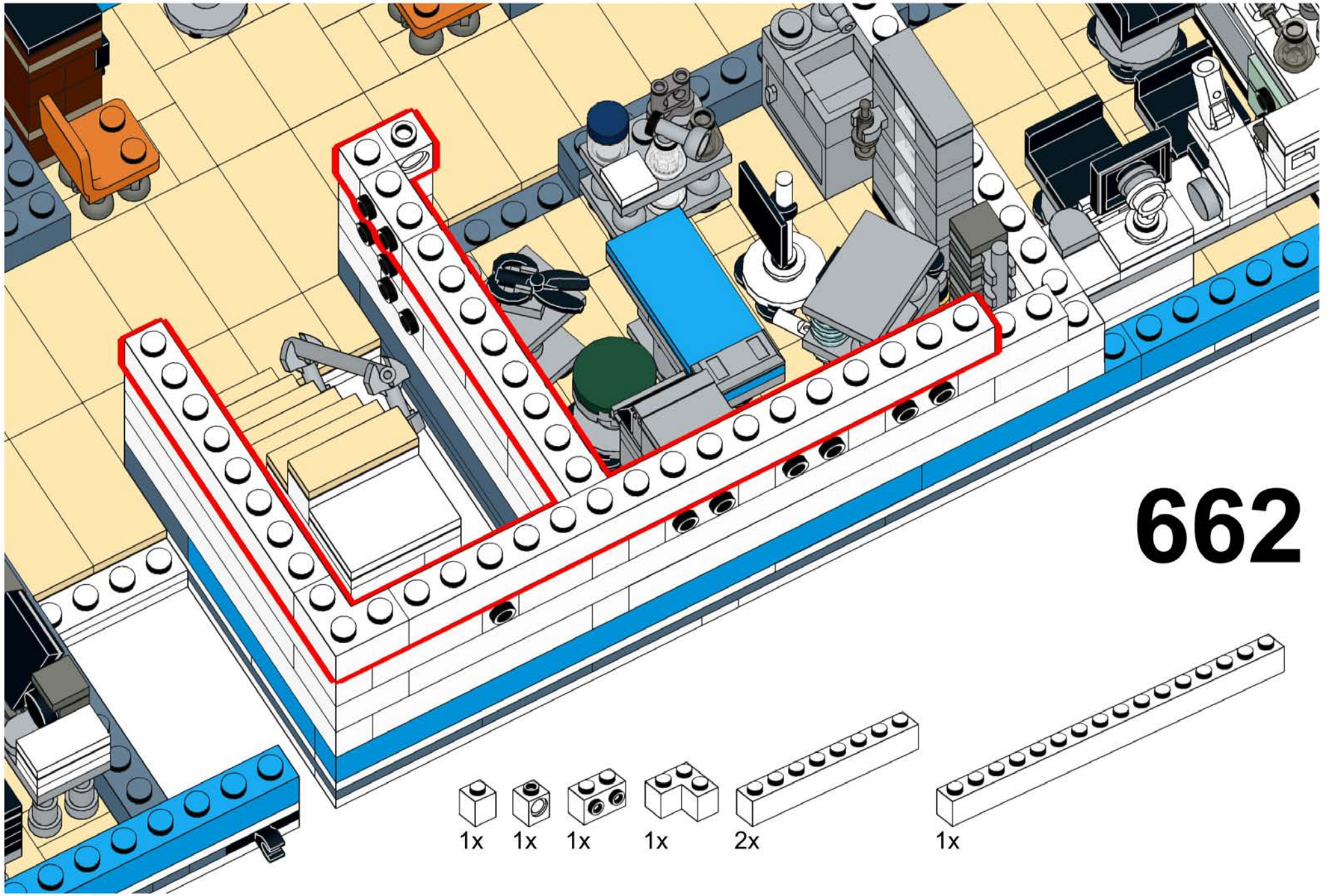



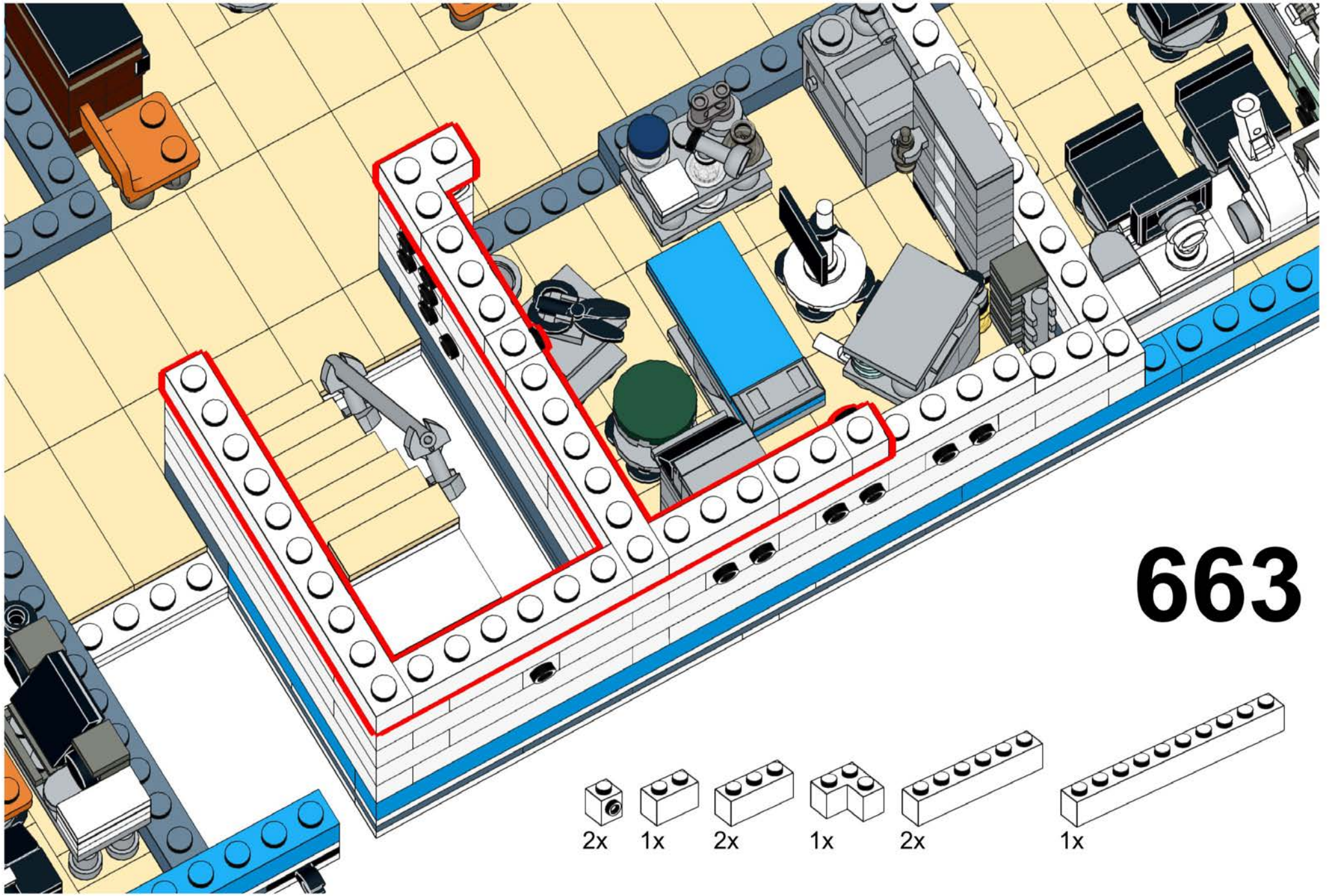

662

- 1x [1x1 white brick]
- 1x [1x1 white brick with hole]
- 1x [1x2 white brick with holes]
- 1x [1x2 white L-shaped brick]
- 2x [1x6 white brick]
- 1x [1x12 white brick]

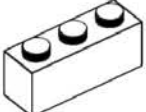

663

- 2x
- 1x
- 2x
- 1x
- 2x
- 1x

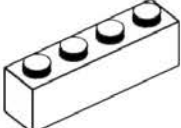
- 1x 
- 1x 
- 1x 
- 1x 
- 1x 

# 664

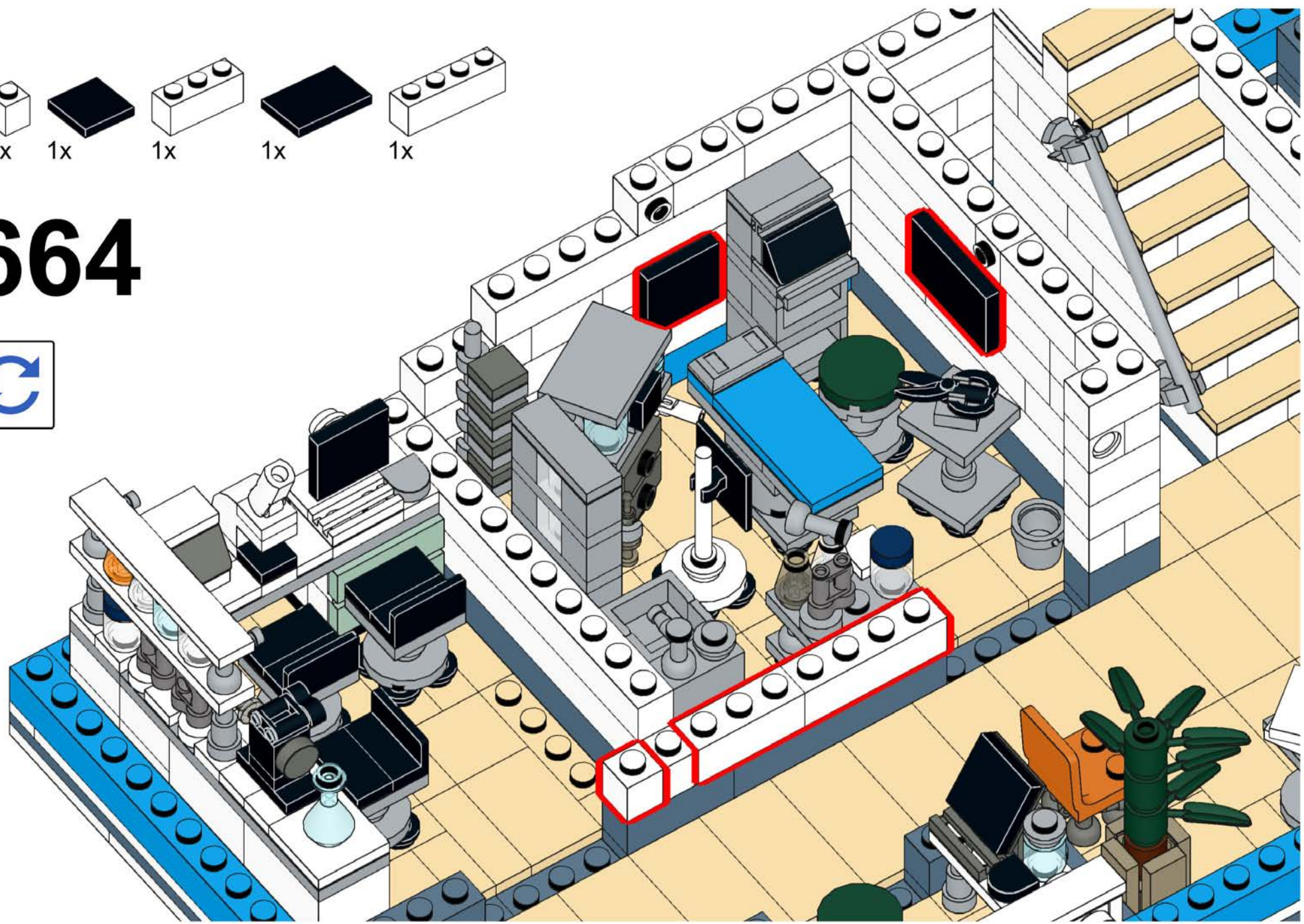



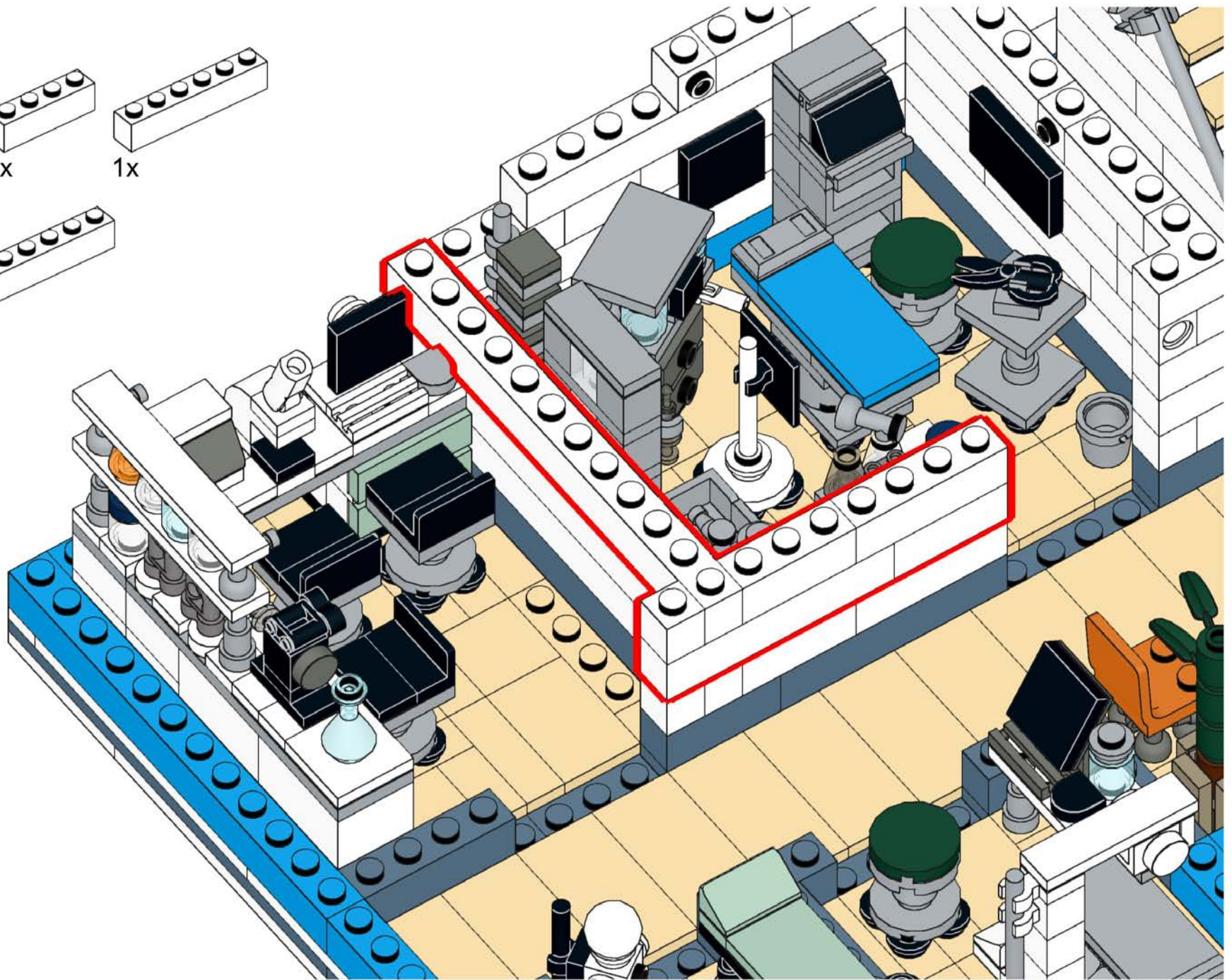
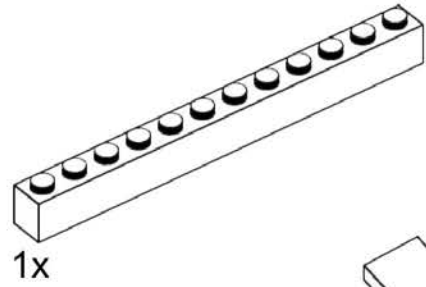
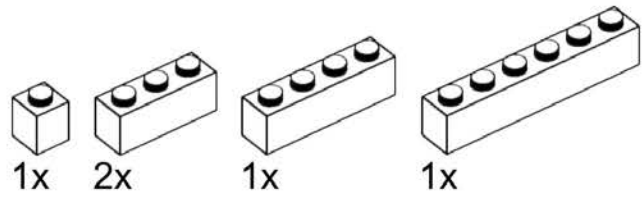

665

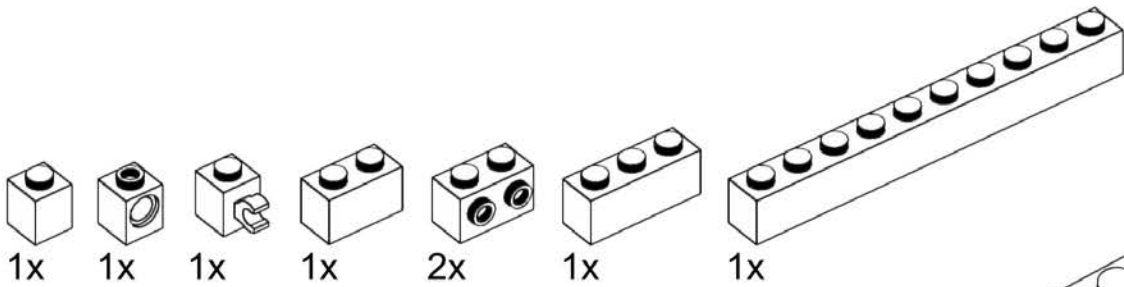

# 666

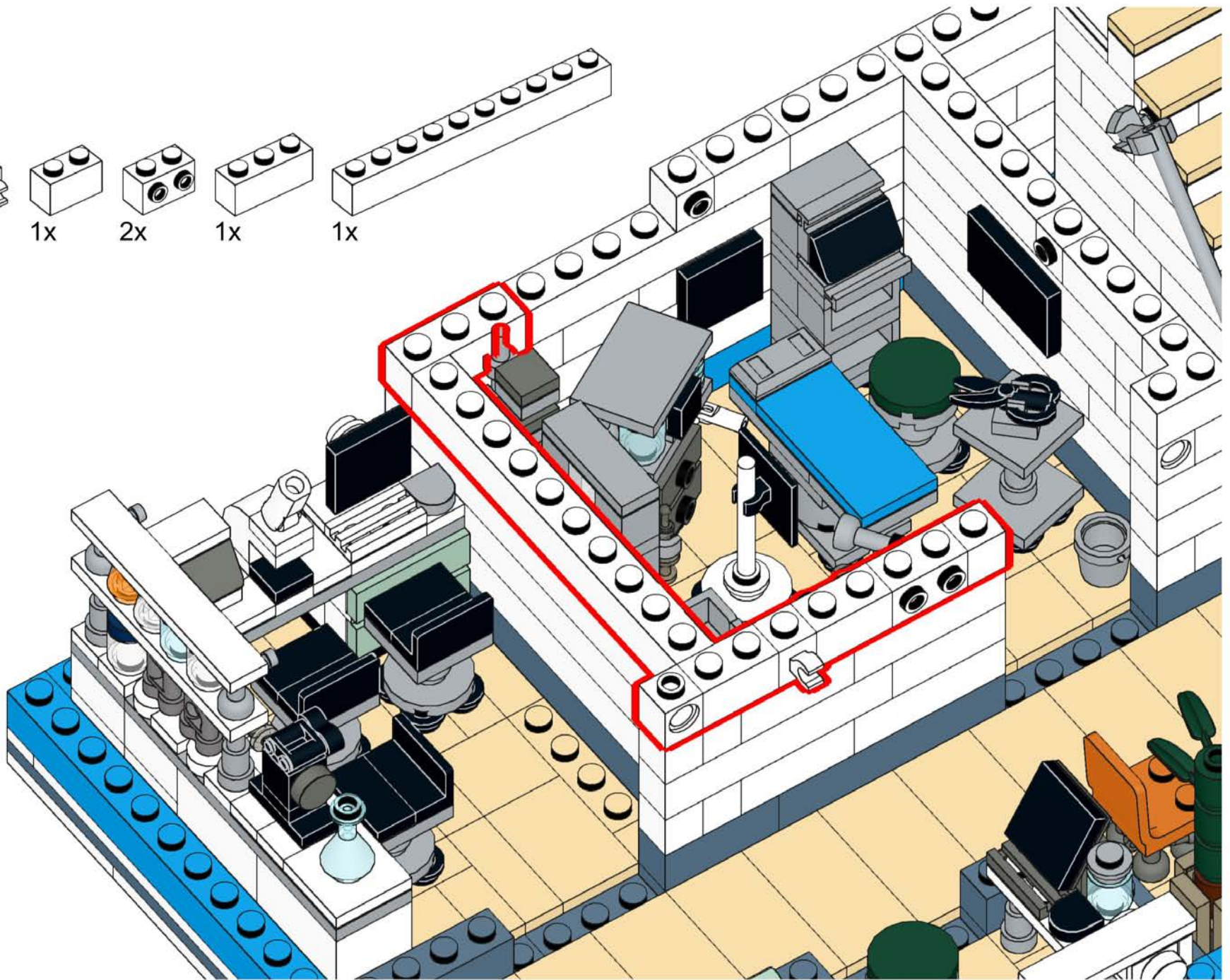

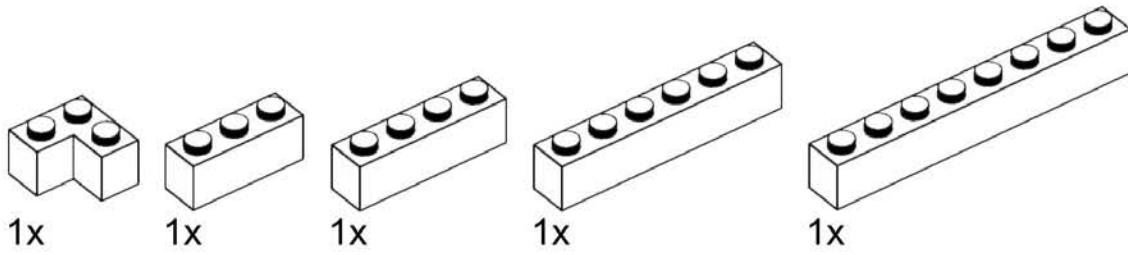

# 667

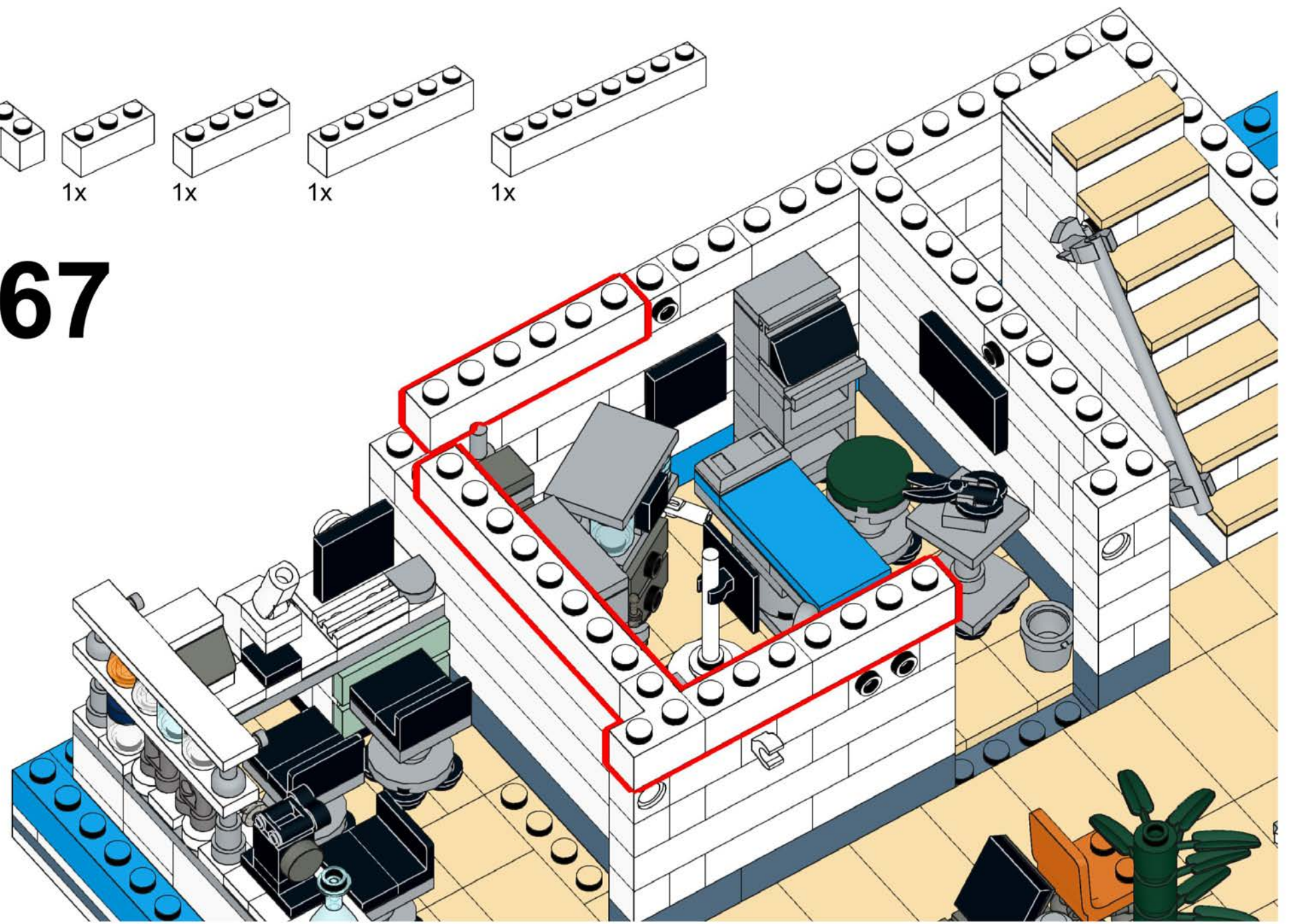

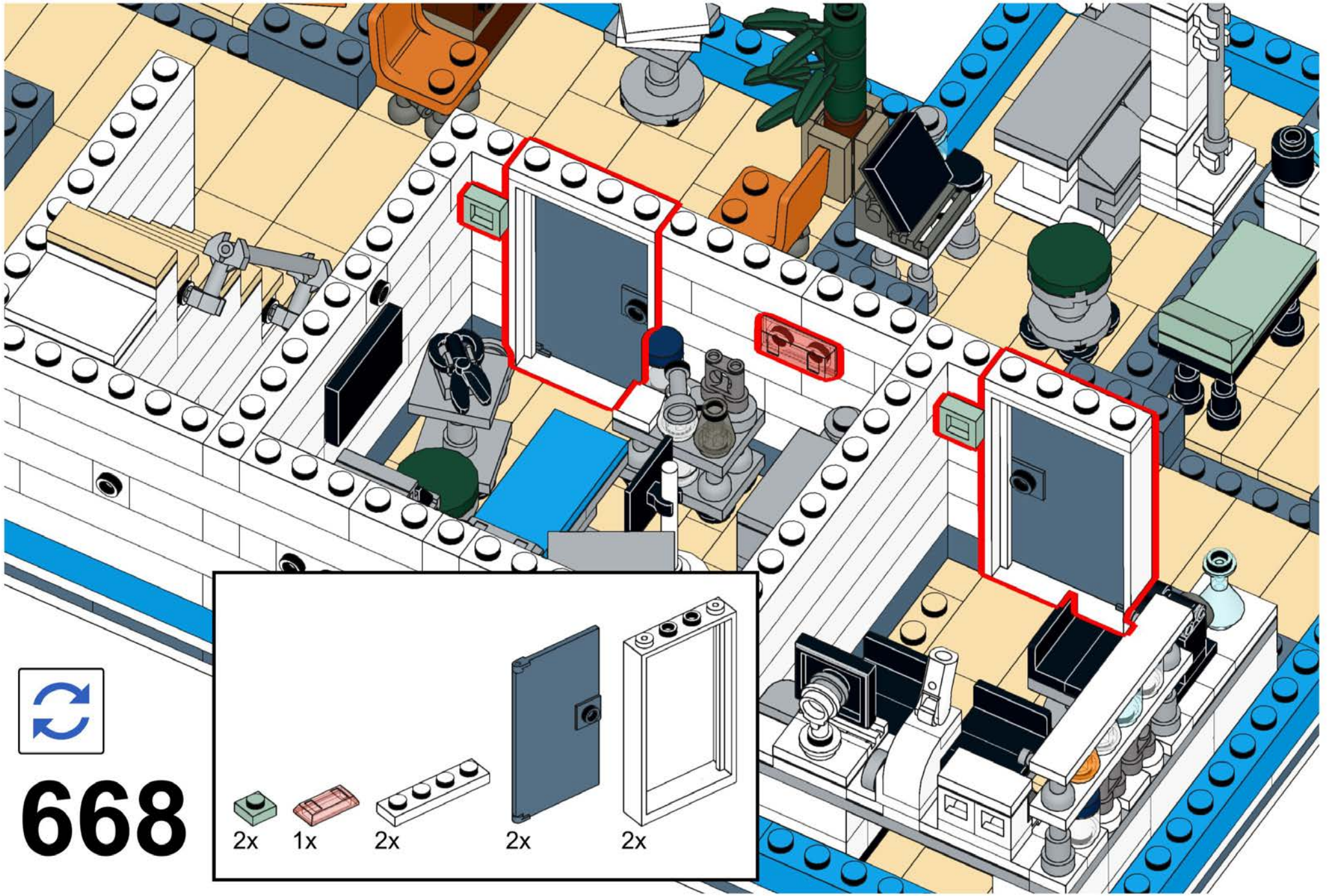

**668**

2x 1x 2x 2x 2x

A parts list for step 668. It includes: 2x small green rectangular pieces, 1x small red rectangular piece, 2x white 1x3 Technic bricks, 2x grey door panels, and 2x white door frames.

# 669

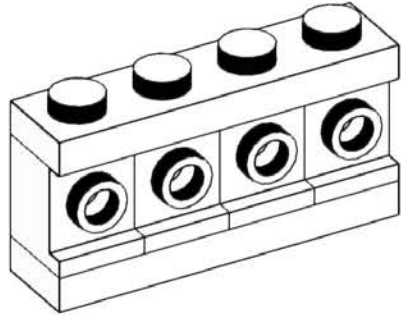
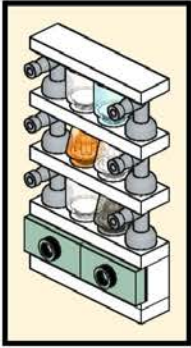
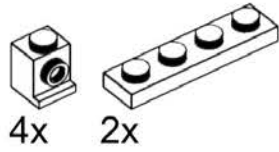

# 670

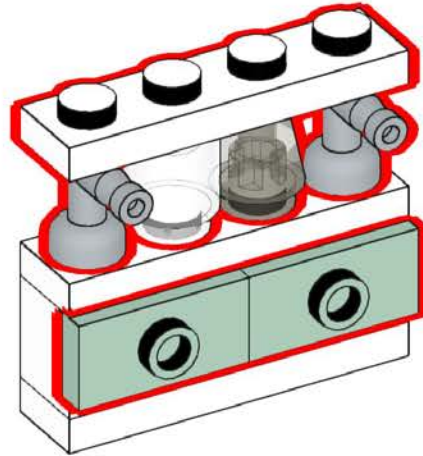
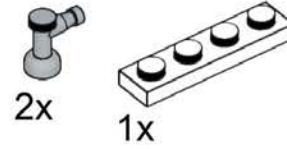
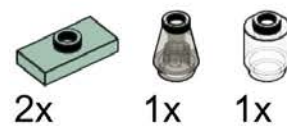

# 671

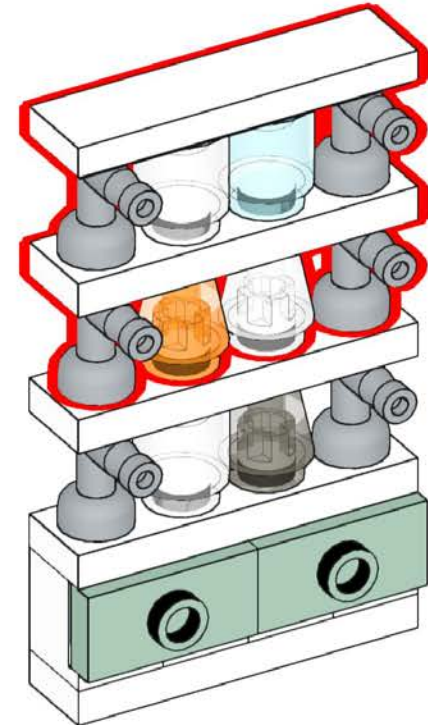
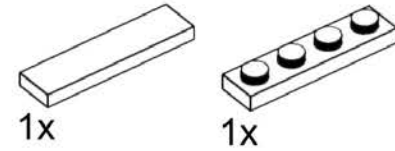
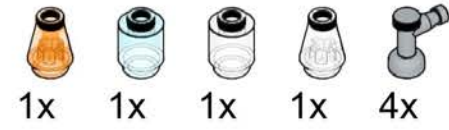

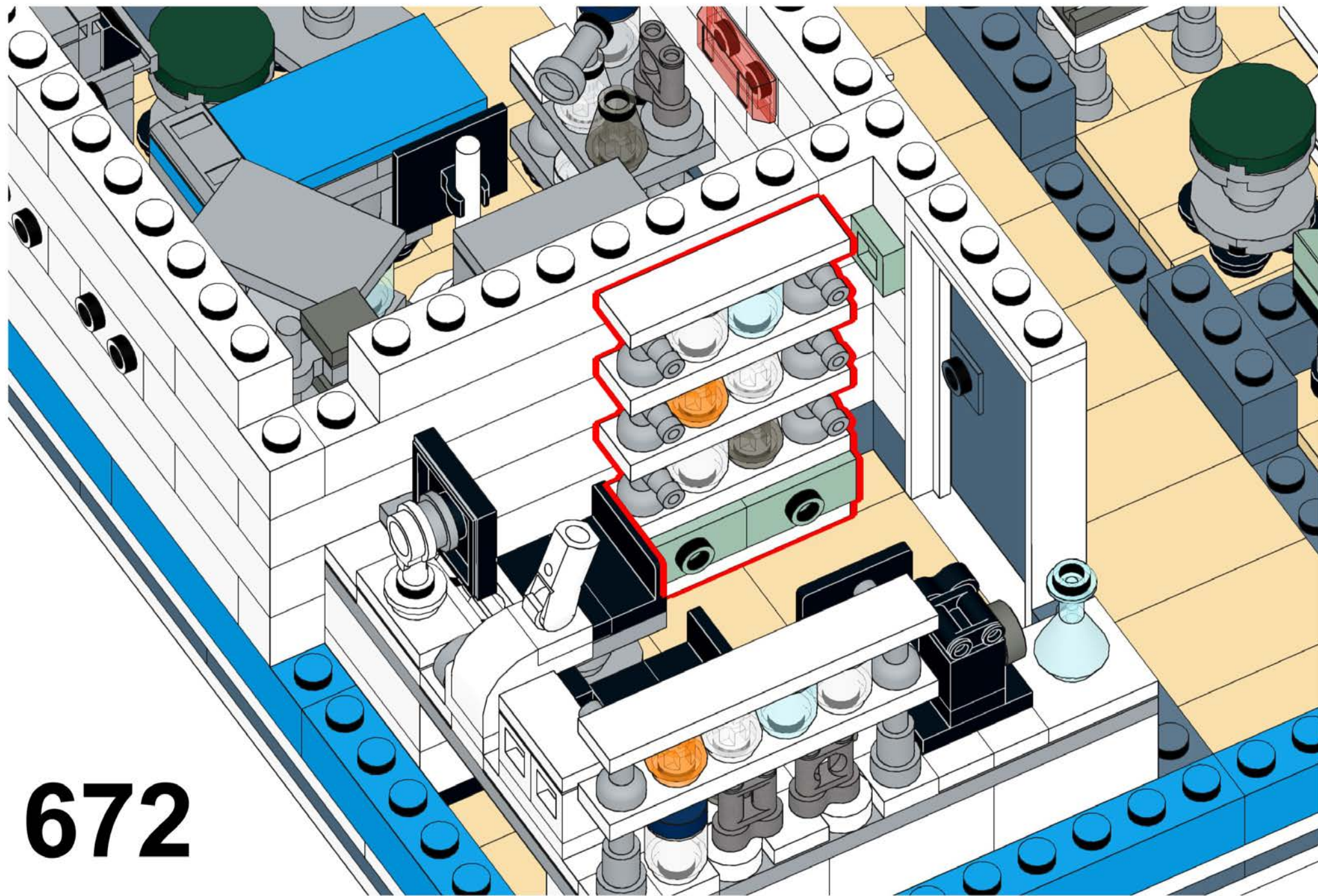

672

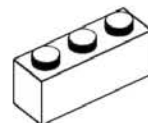
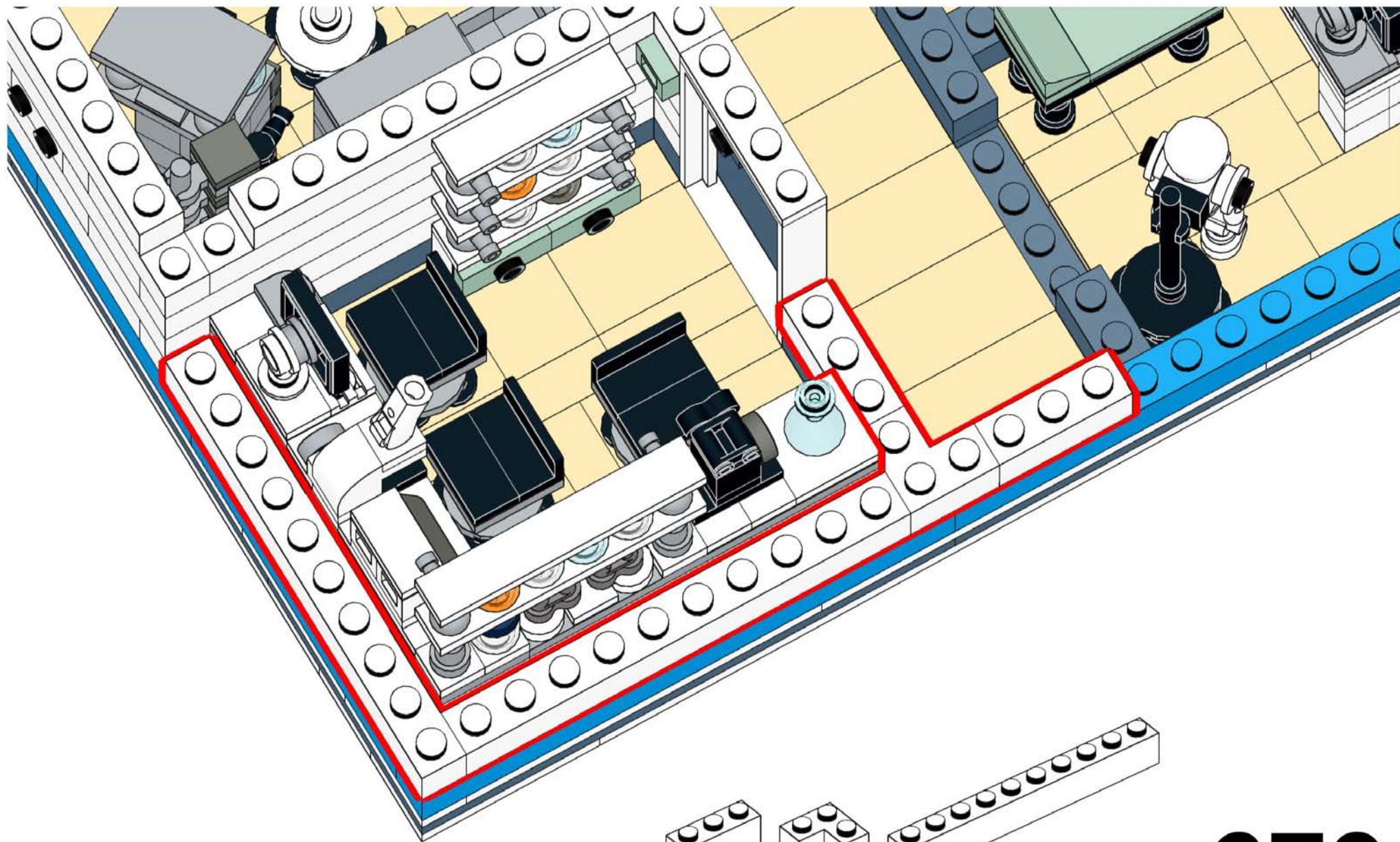

2x

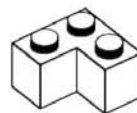

1x

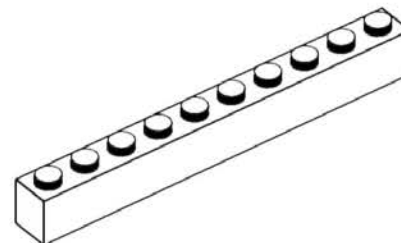

2x

# 673

# 674

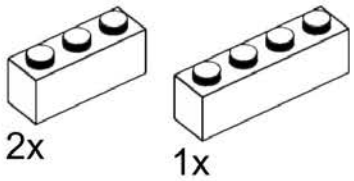
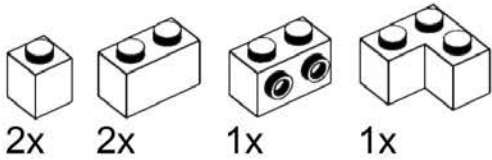
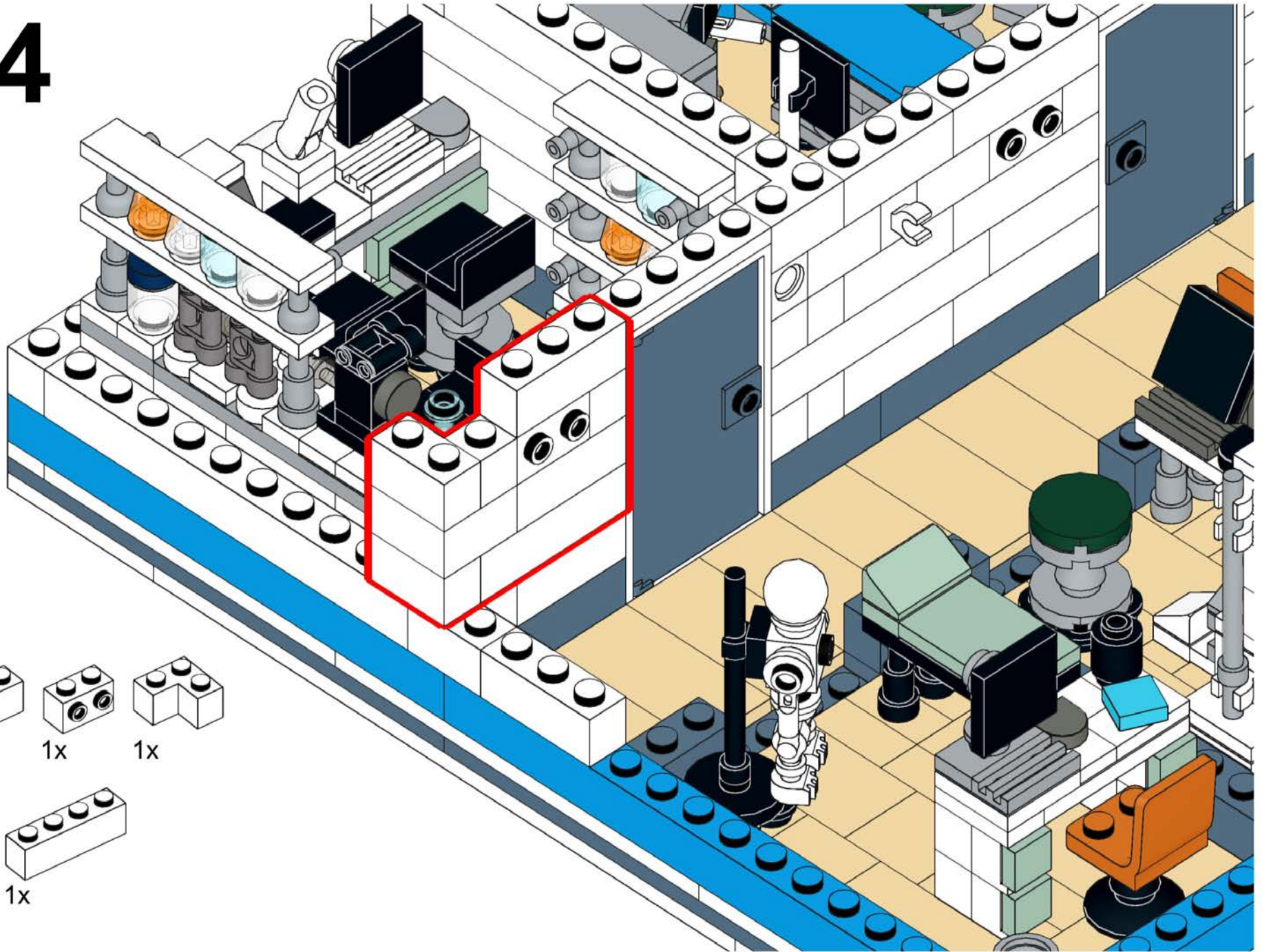



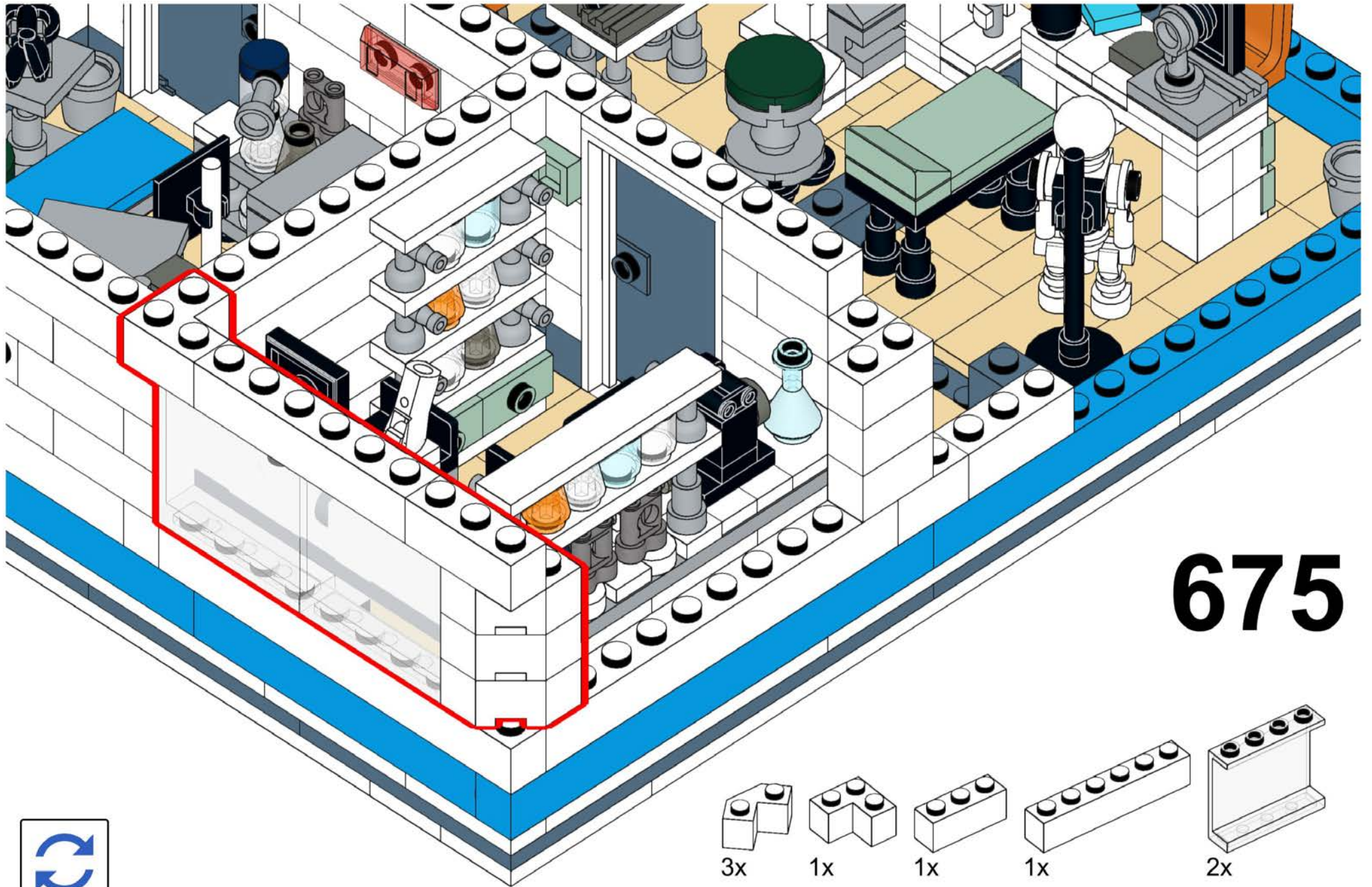

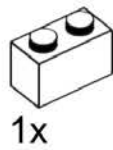
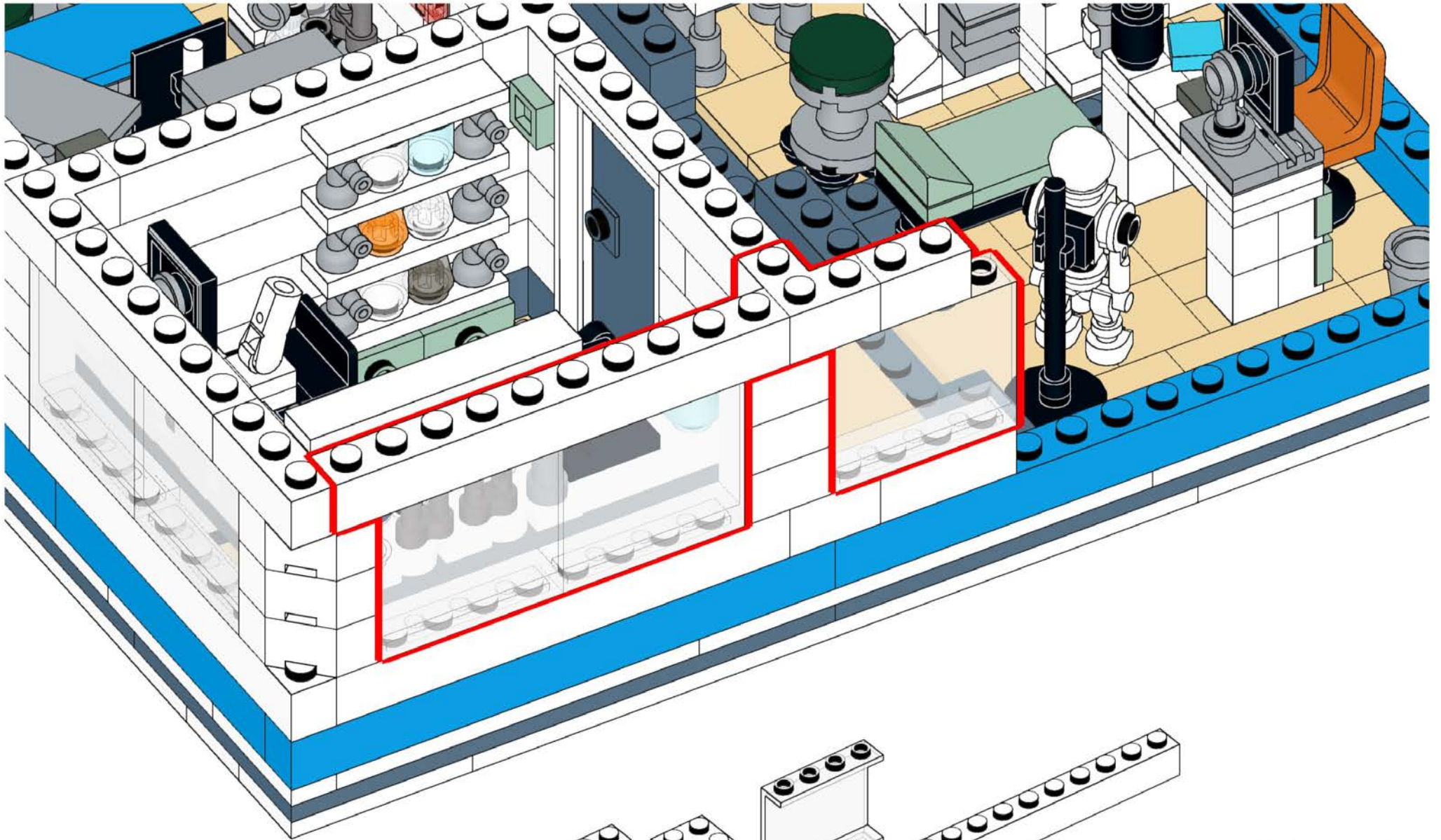

1x

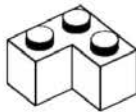

1x





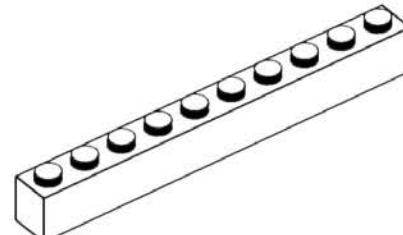

3x



1x



# 676

# 677

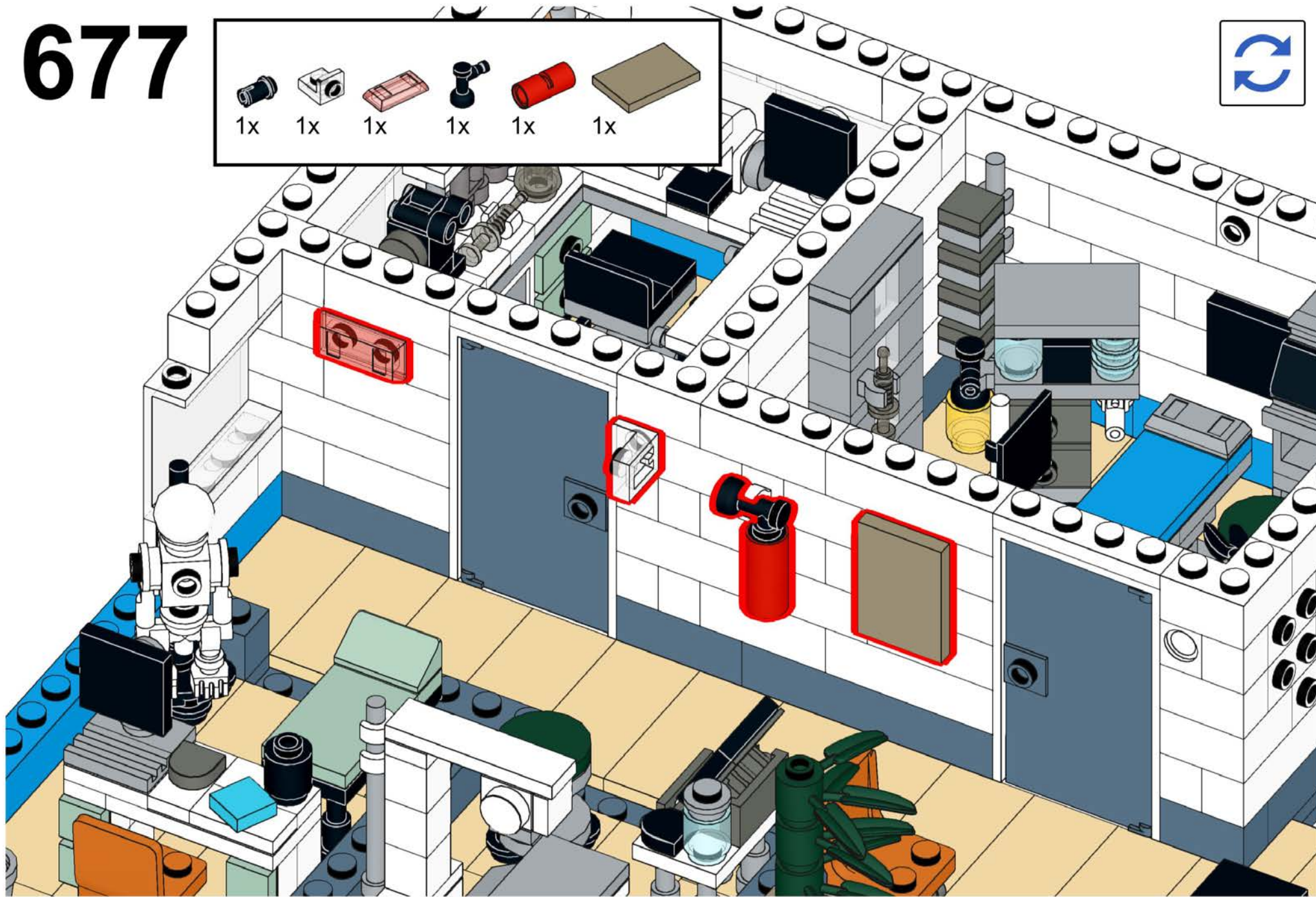
					
1x	1x	1x	1x	1x	1x

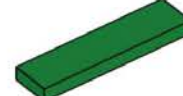
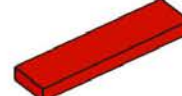

# 678

- 1x  1x 
- 1x  1x 

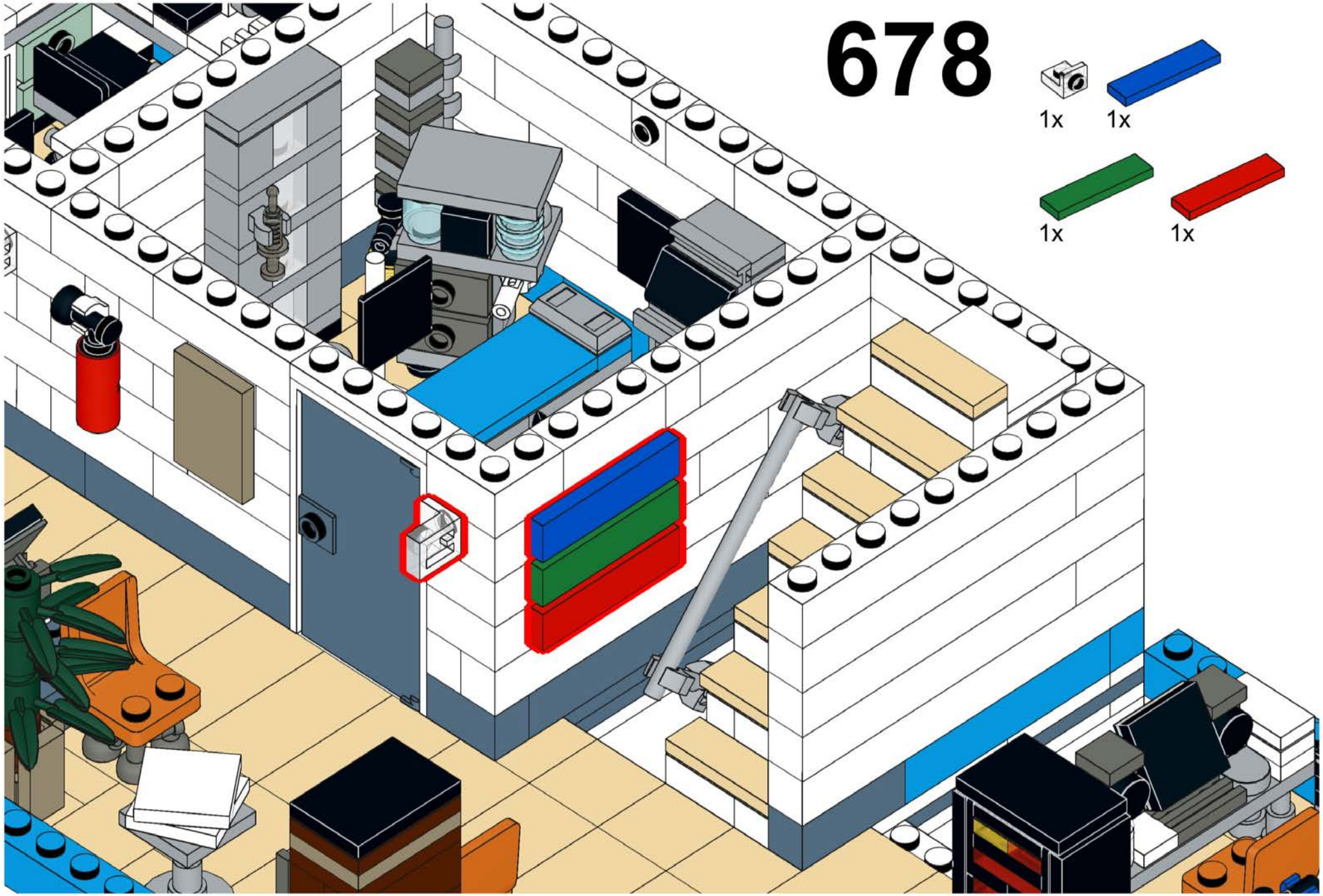

# 679



1x



1x

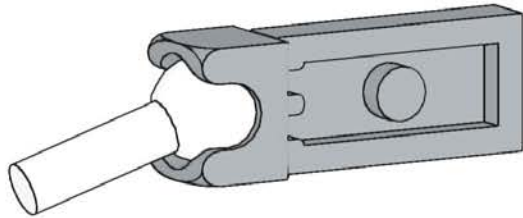
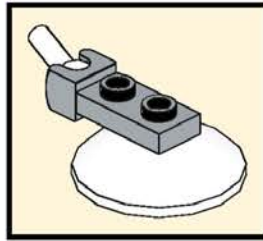

# 680



1x



1x



1x

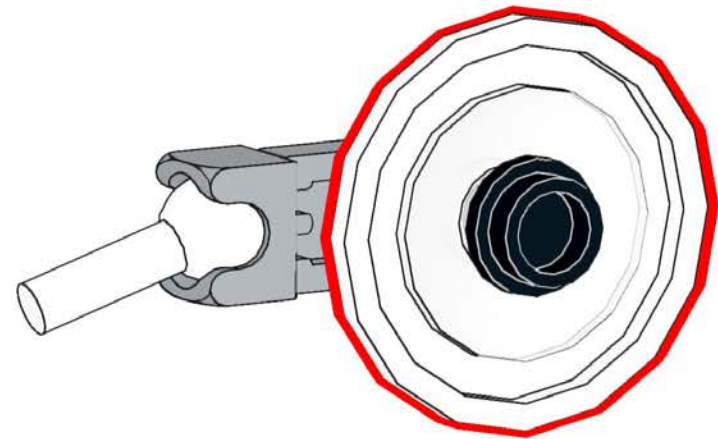

# 681

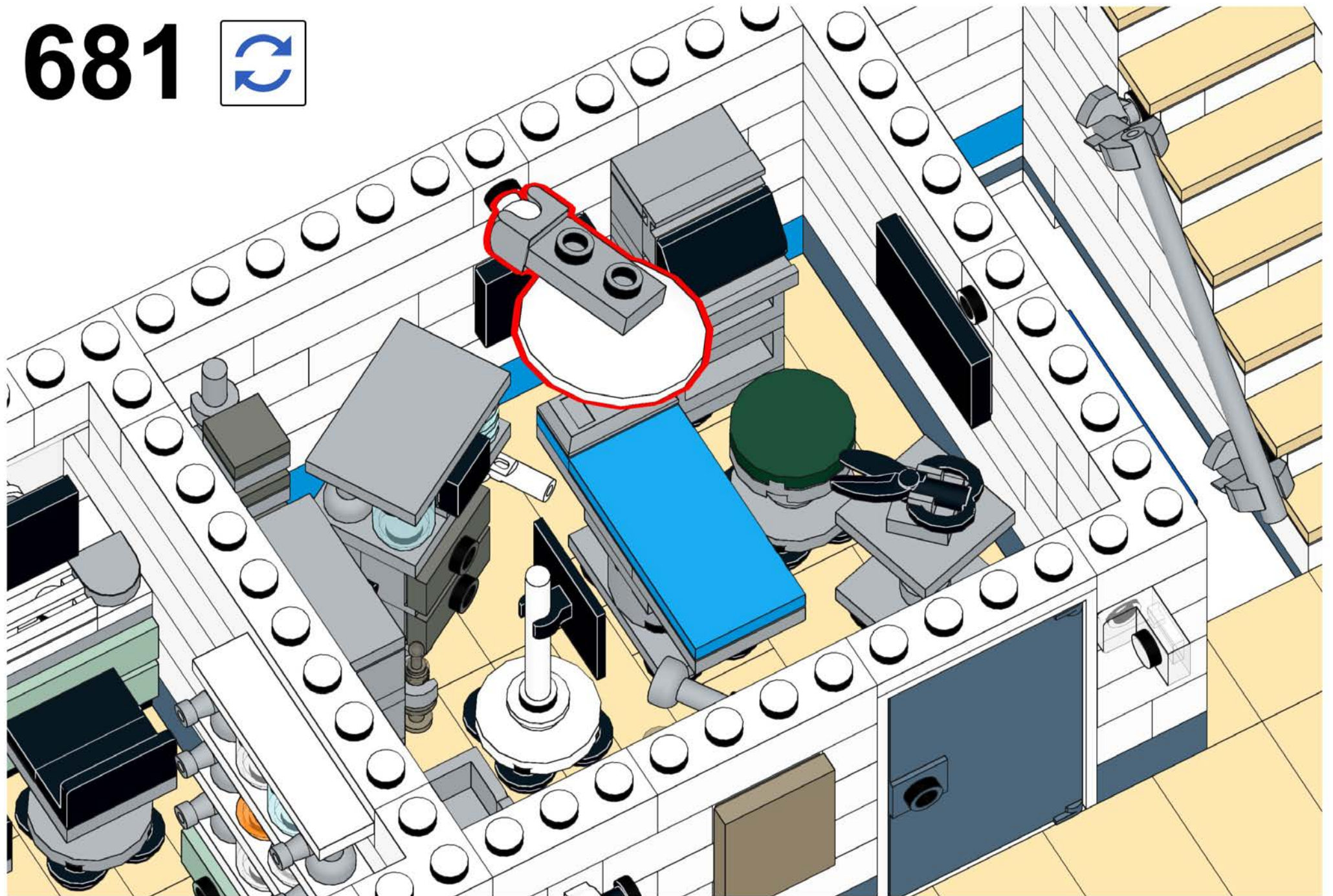

# 682

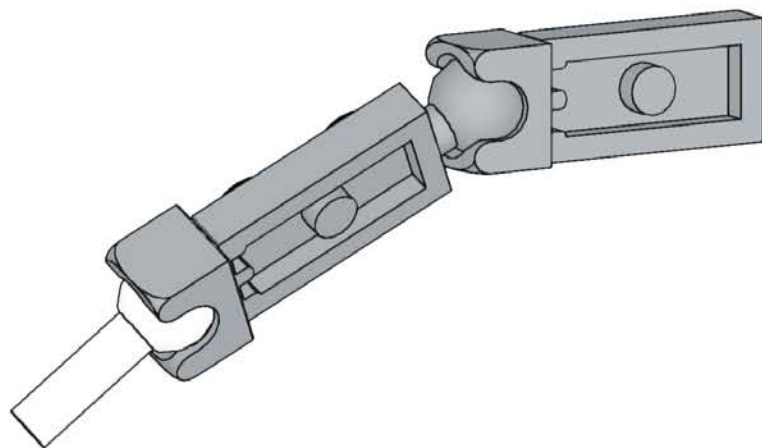
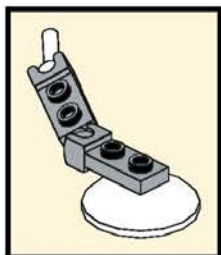
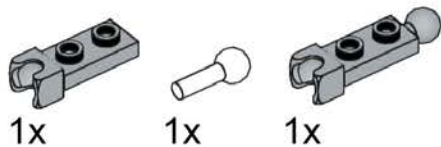

# 683

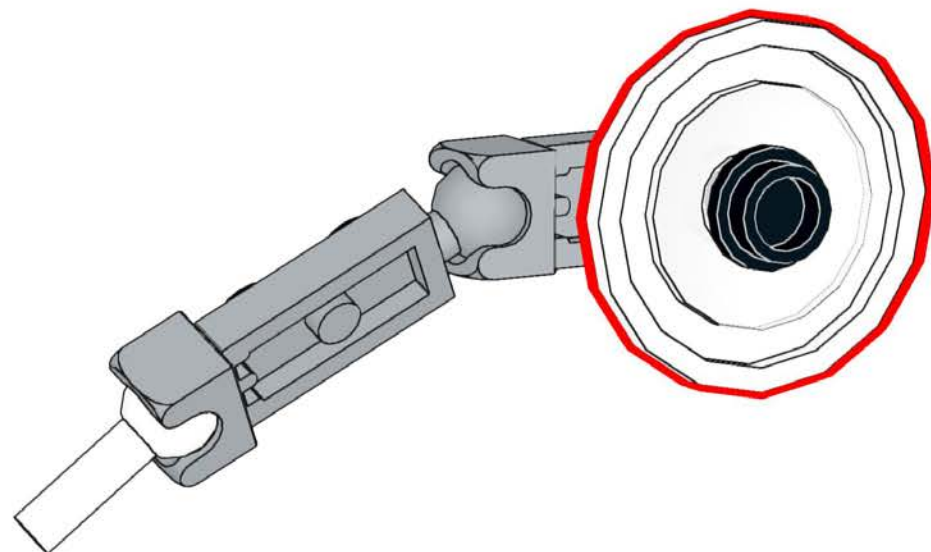
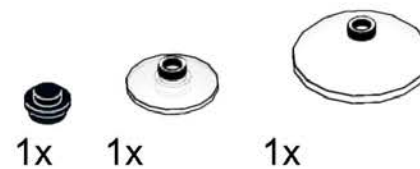

684

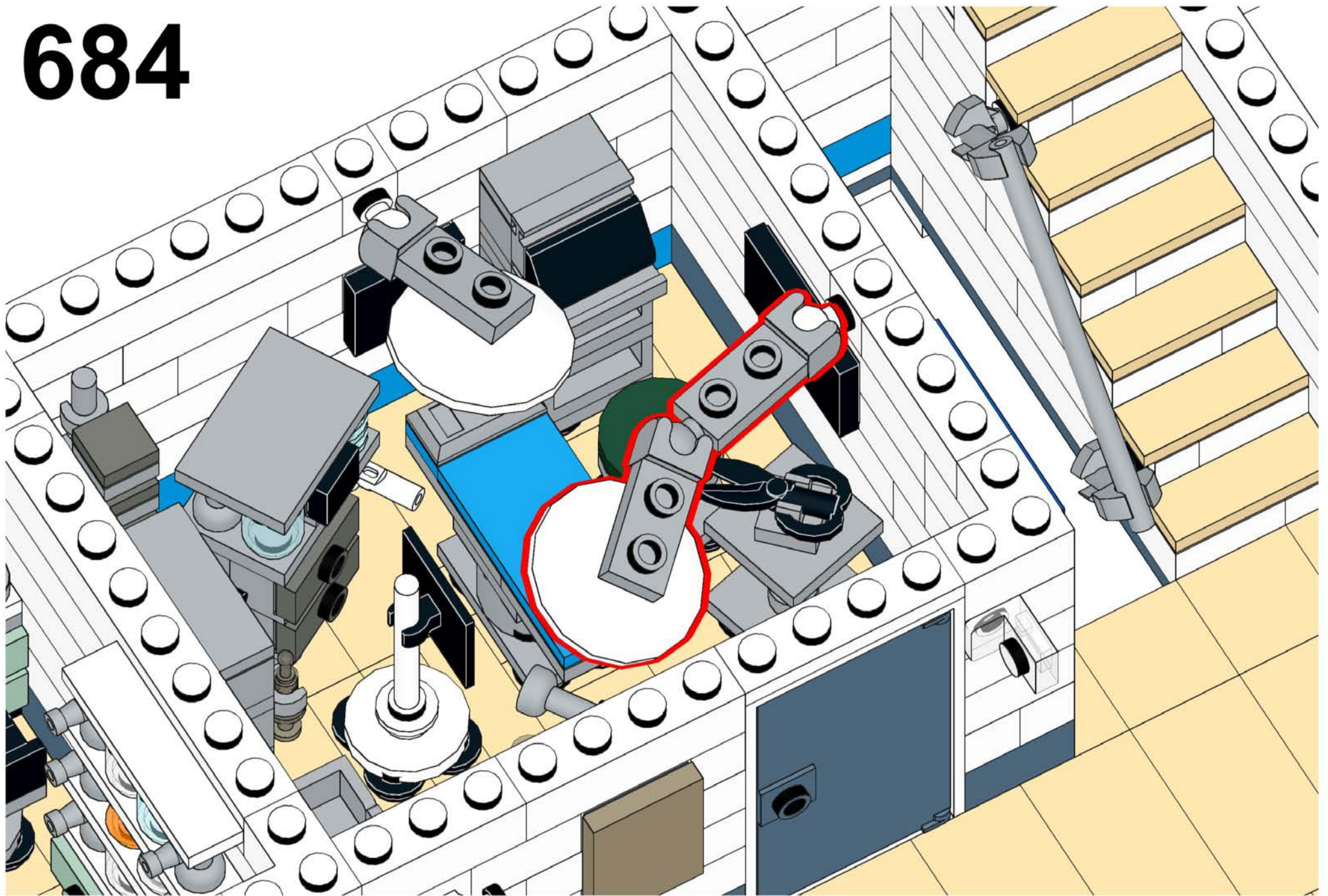



# 685

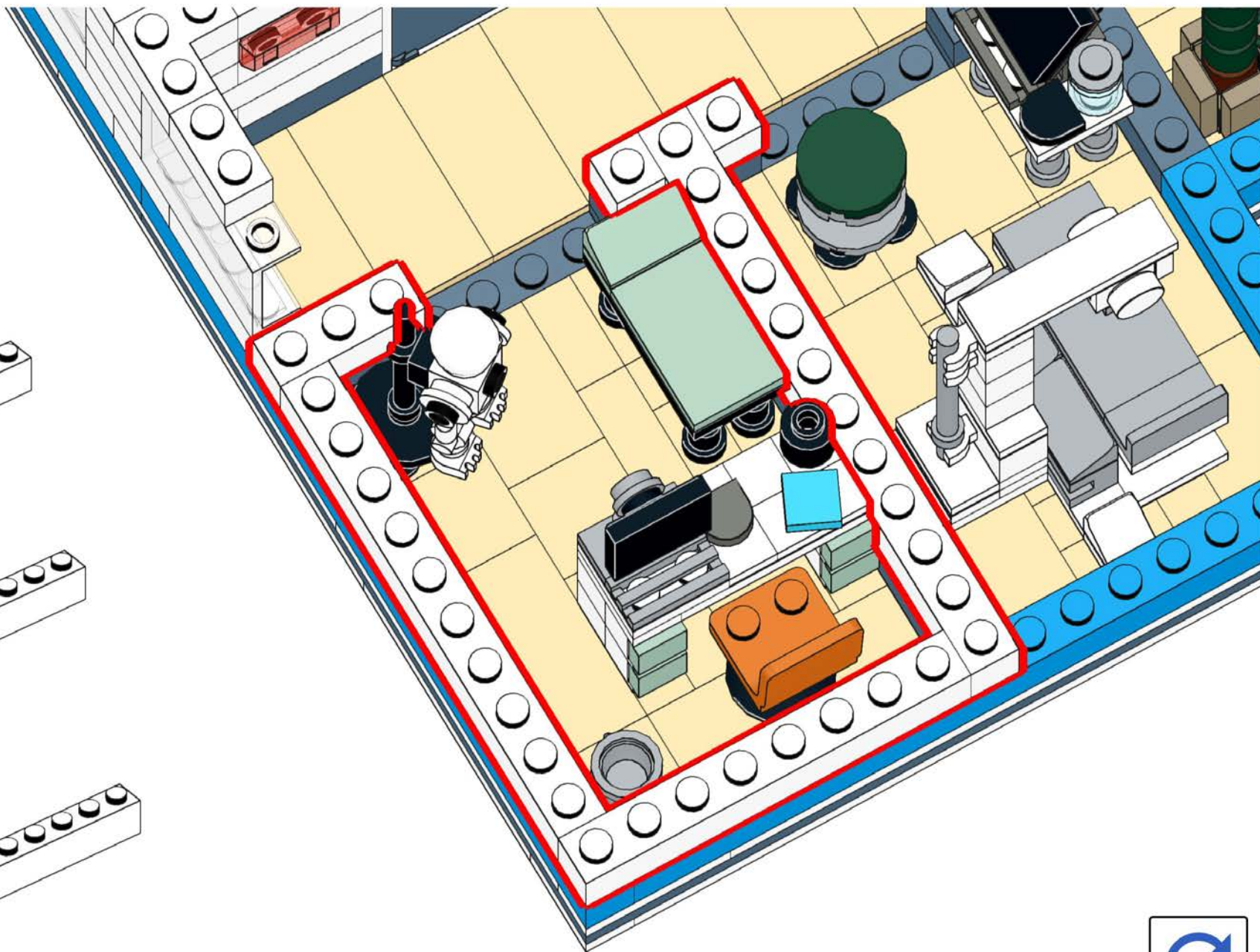
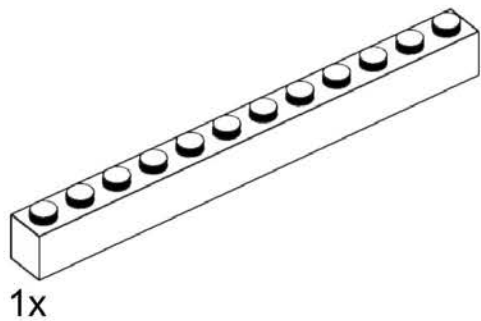
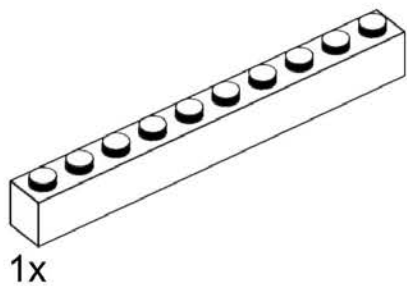
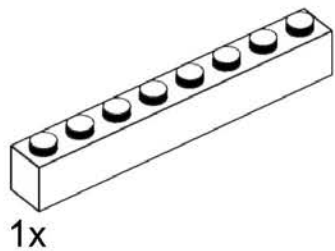
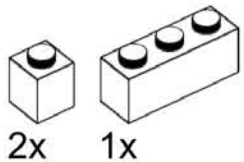

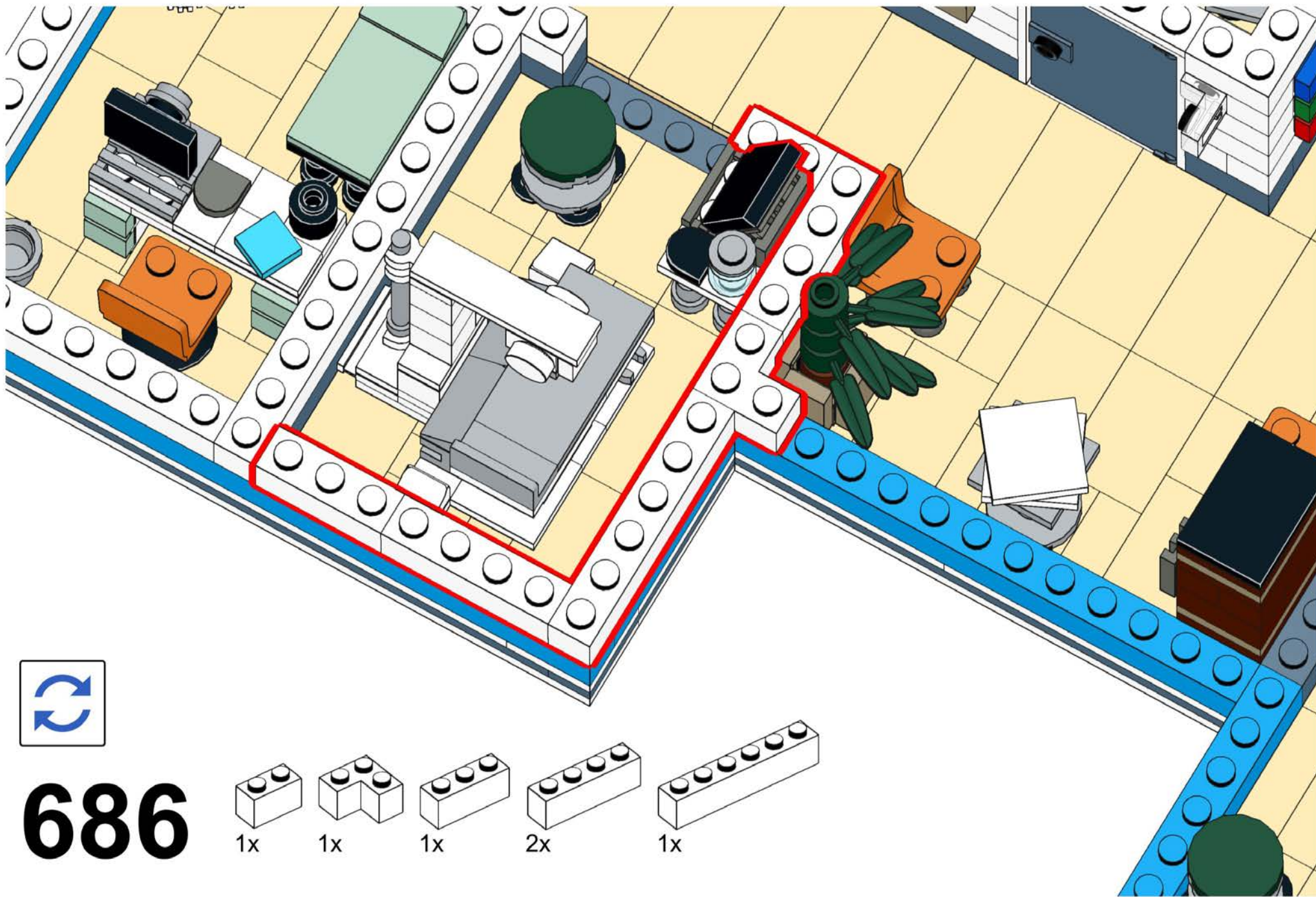

686

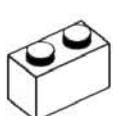

1x

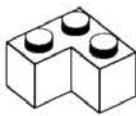

1x

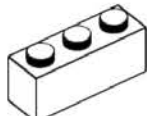

1x

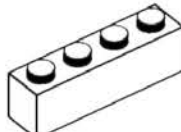

2x

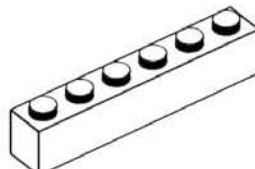

1x

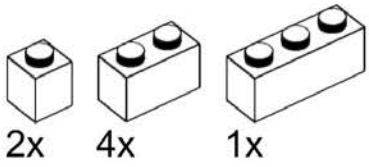
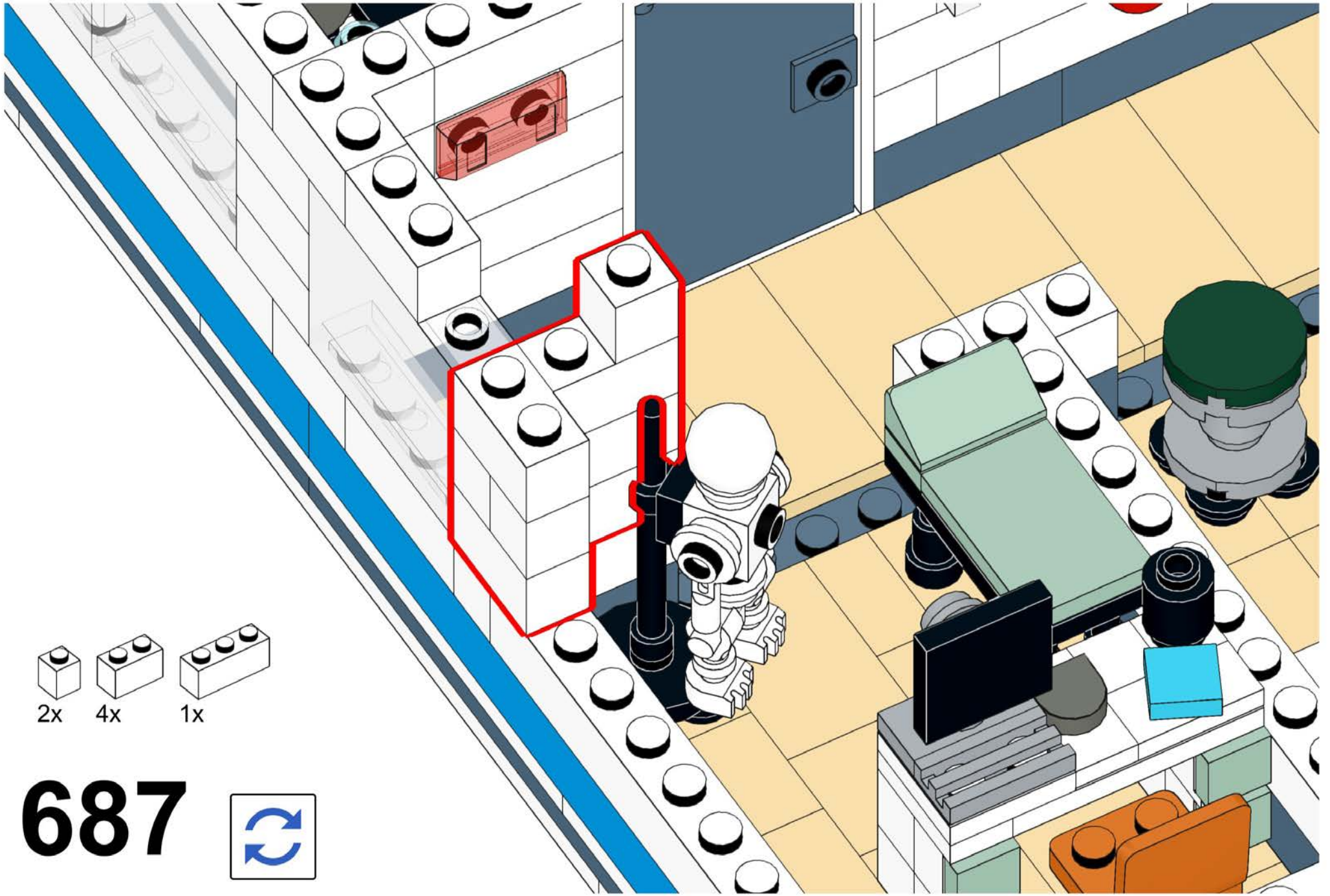

687



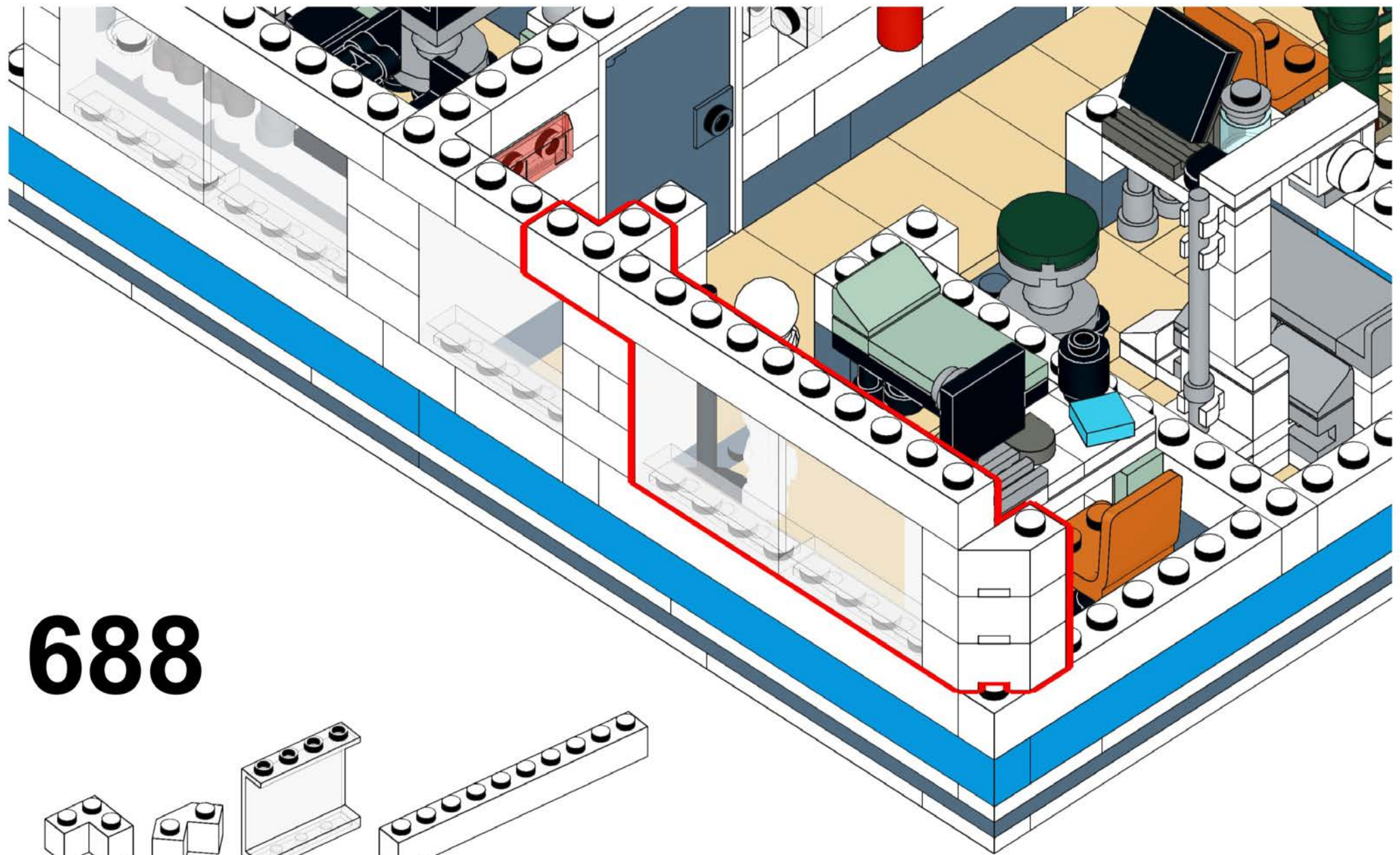

688

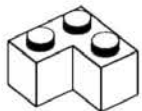

1x

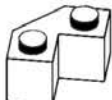

3x



2x

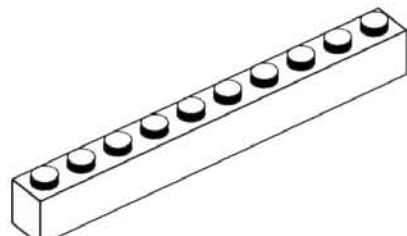

1x

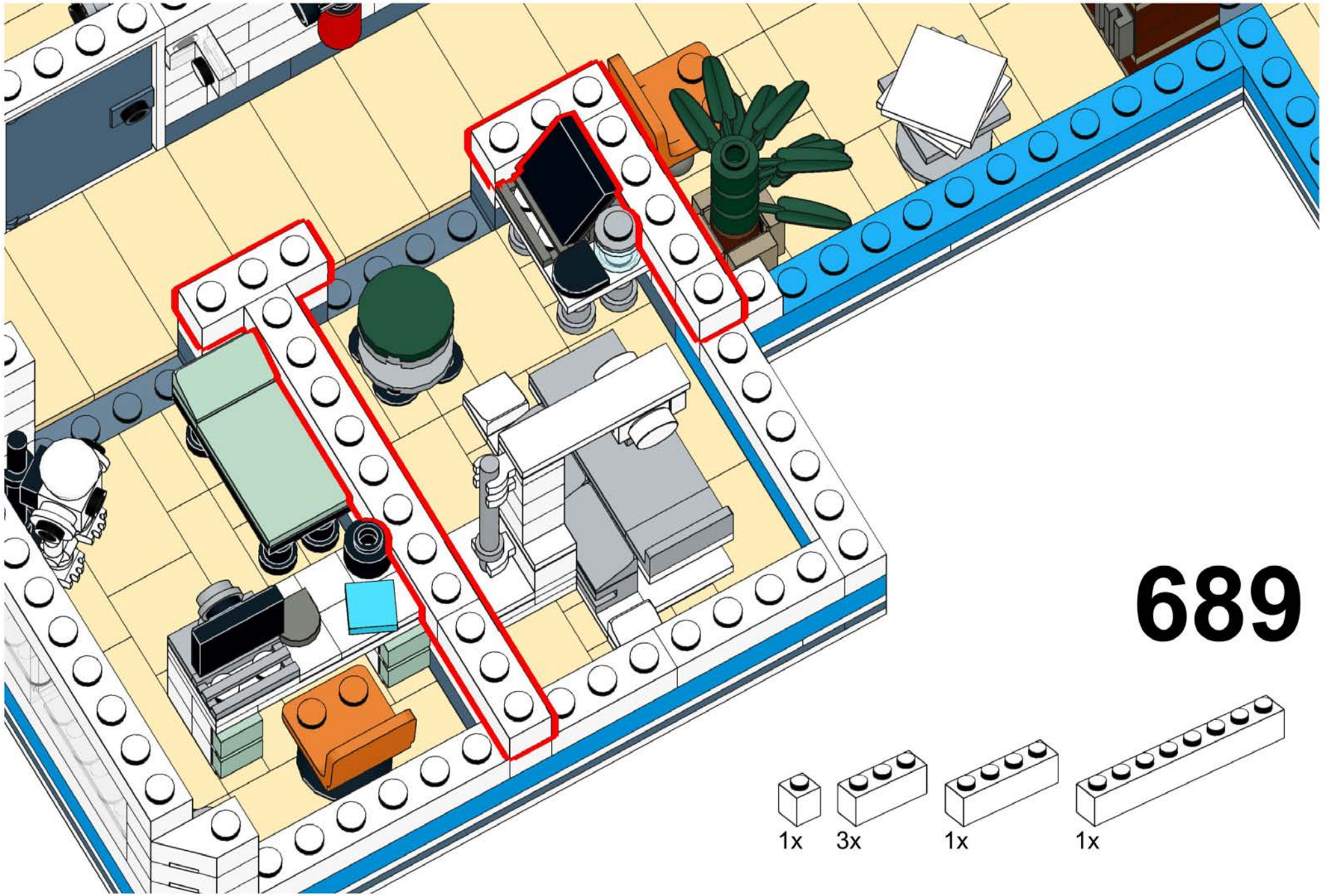

689

- 1x [1x1 white brick]
- 3x [1x3 white brick]
- 1x [1x5 white brick]
- 1x [1x7 white brick]

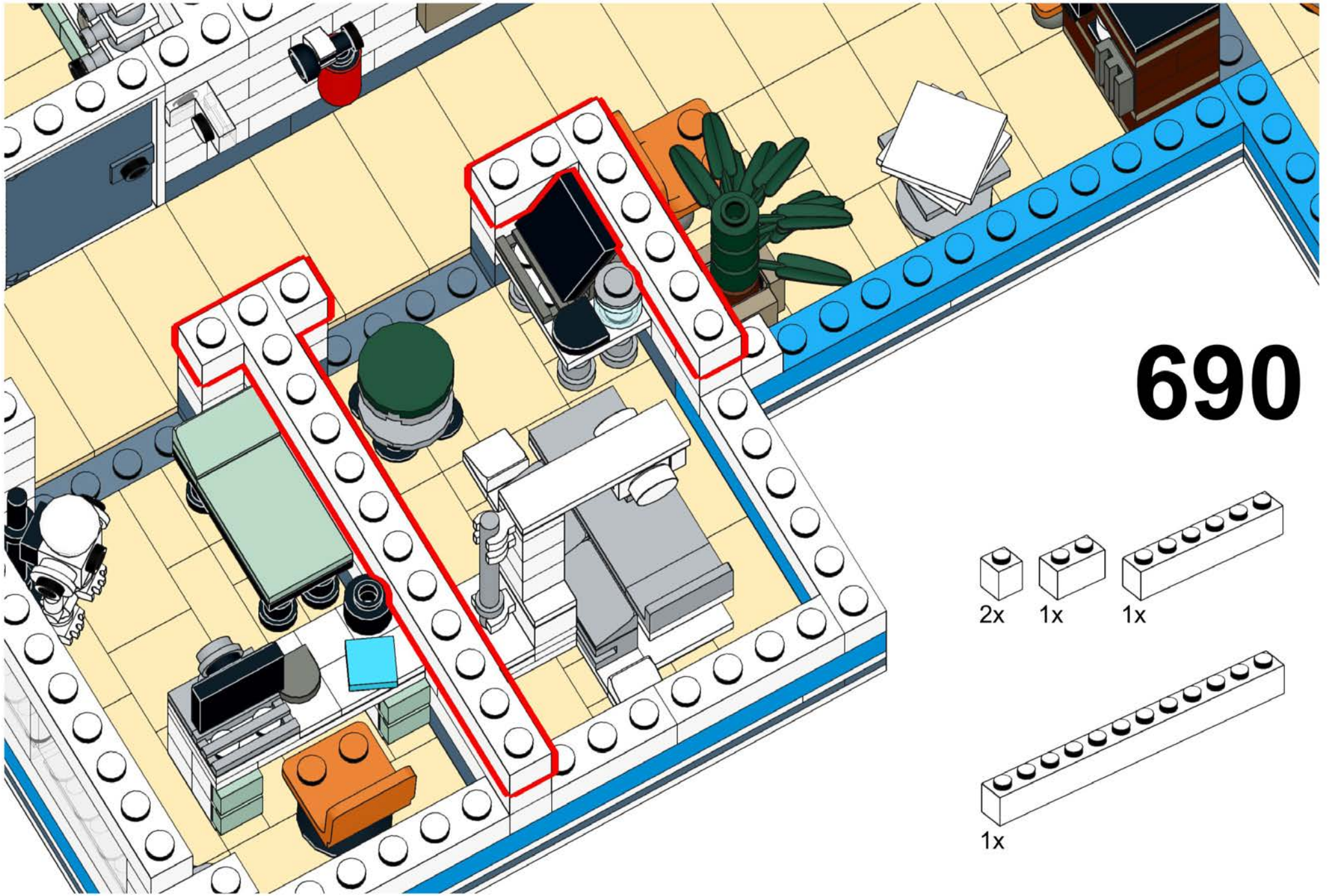

**690**

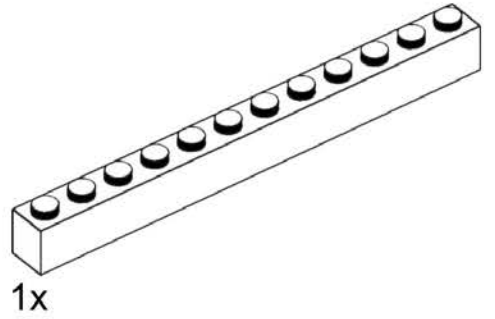
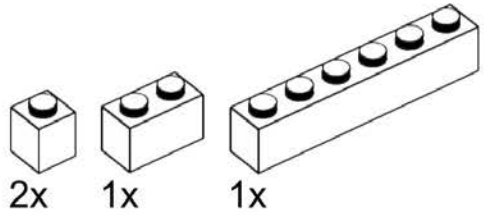

# 691

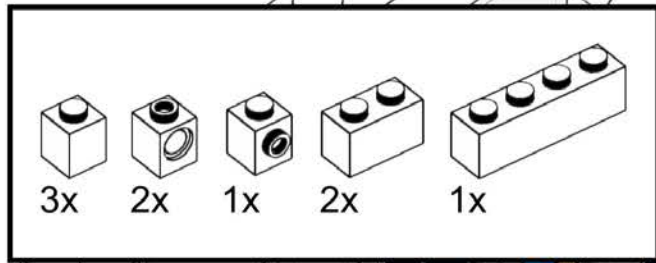

3x 2x 1x 2x 1x

This inset box lists the required parts for step 691. It contains five items: three 1x1 white Technic bricks, two 1x2 white Technic bricks, one 1x3 white Technic brick, two 1x4 white Technic bricks, and one 1x6 white Technic brick. Each item is accompanied by its quantity.

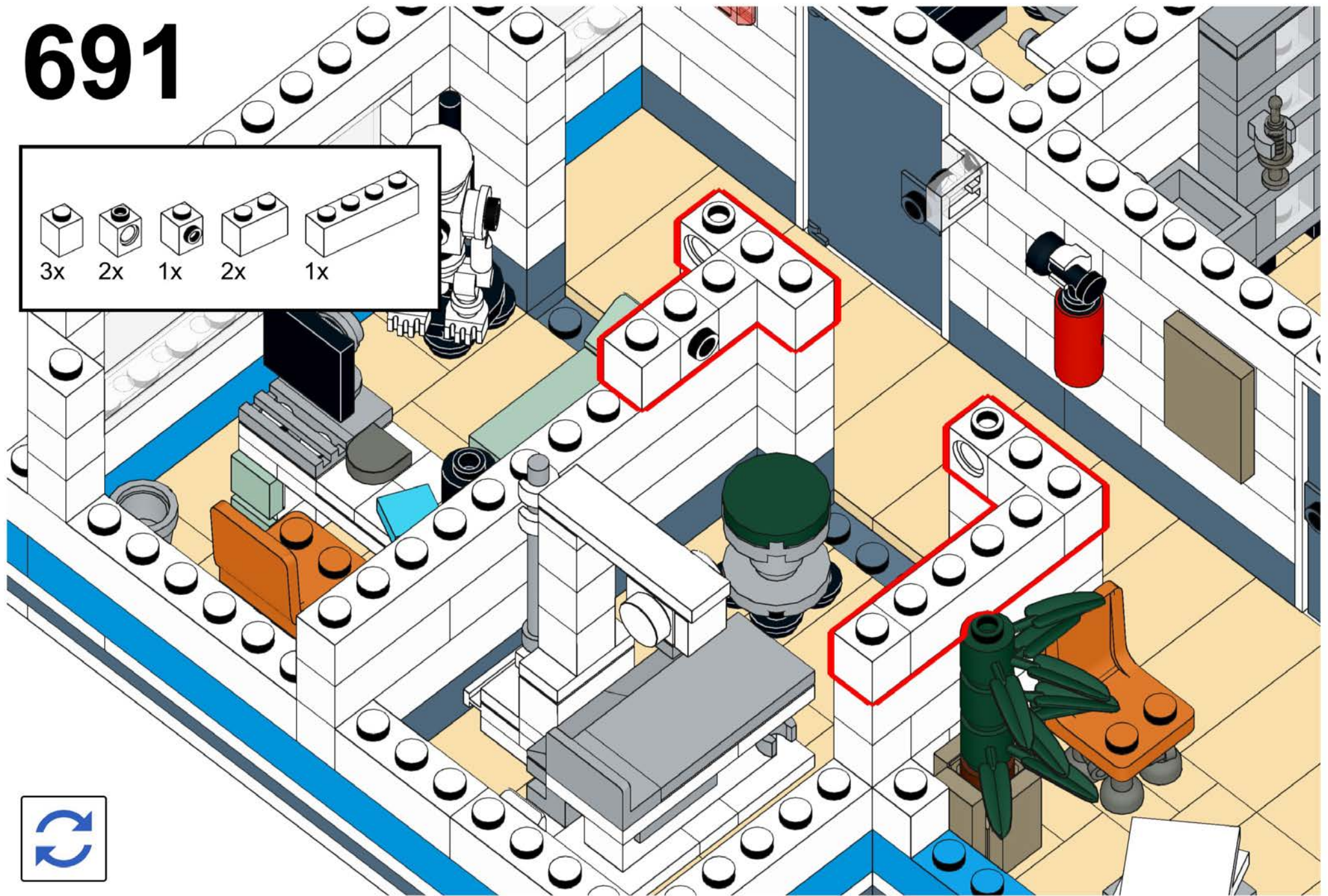

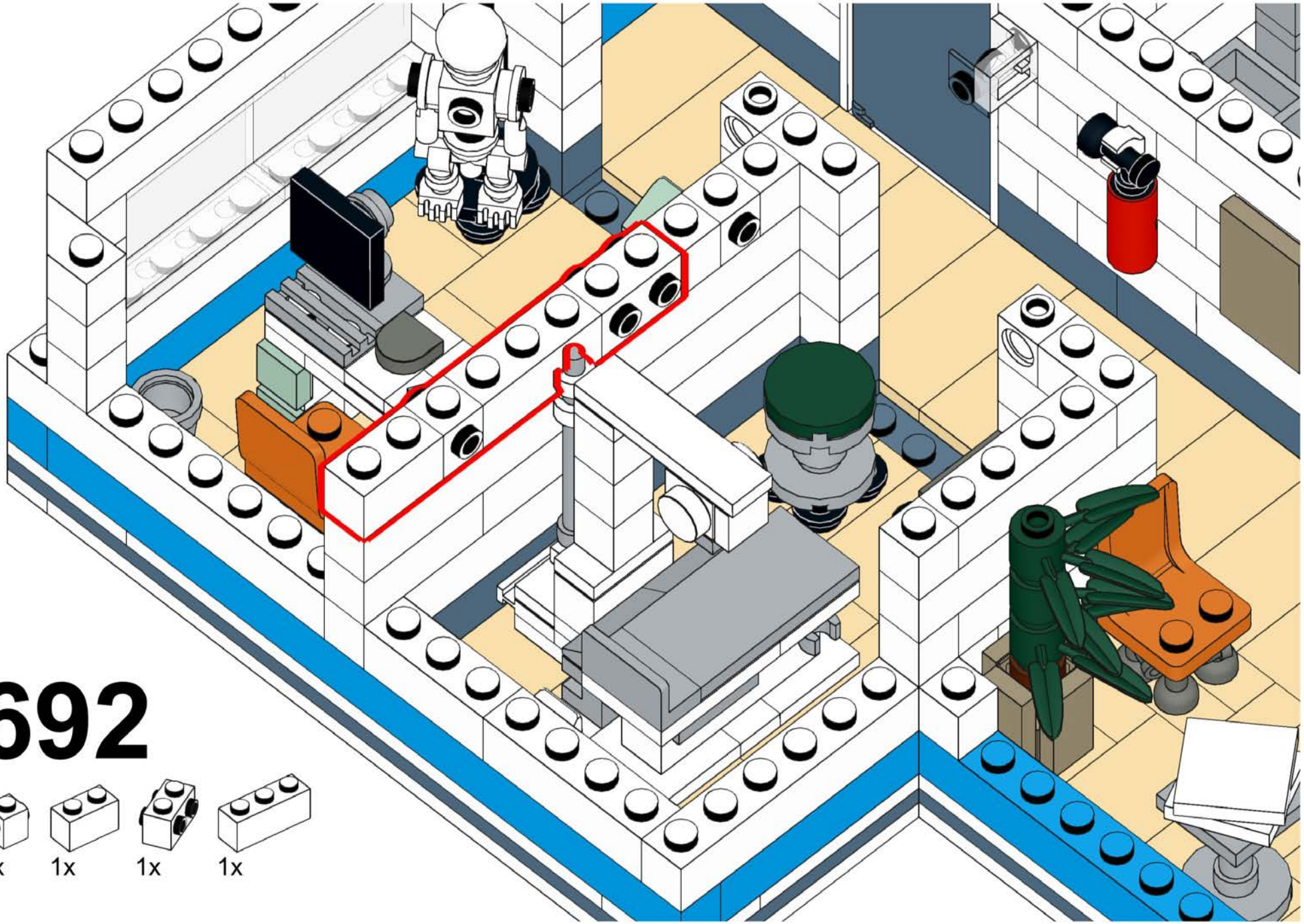

692

- 1x
- 1x
- 1x
- 1x



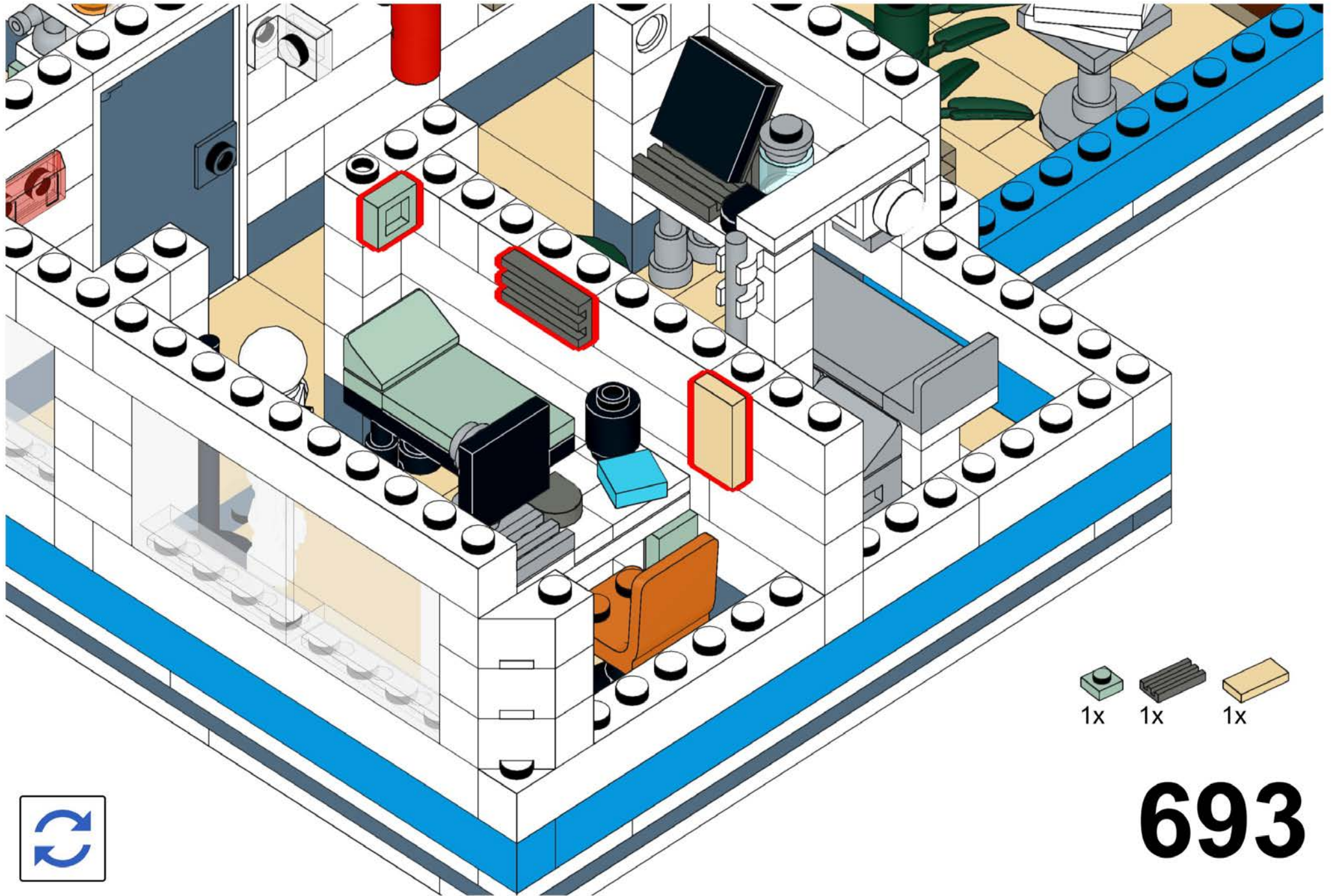

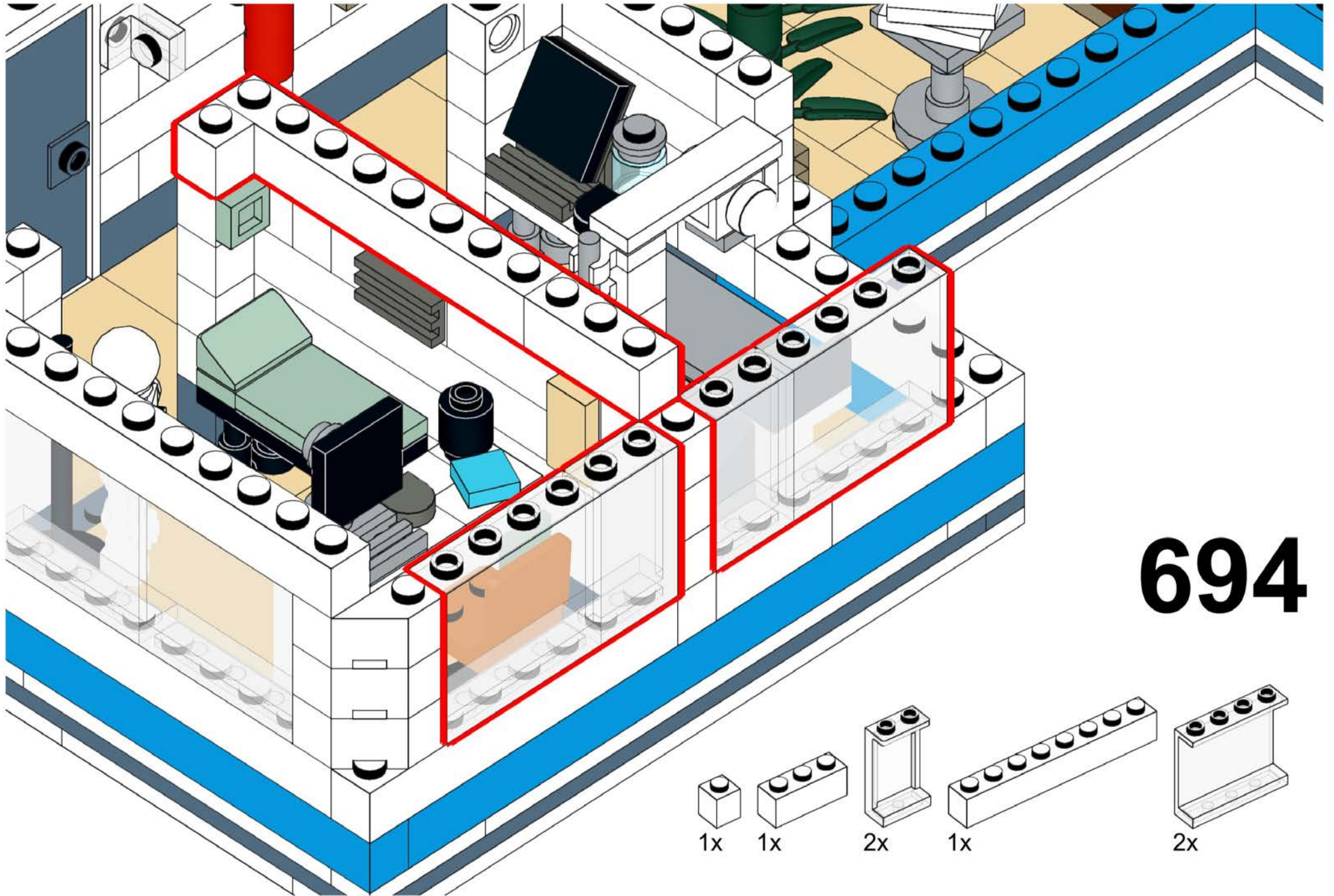

694

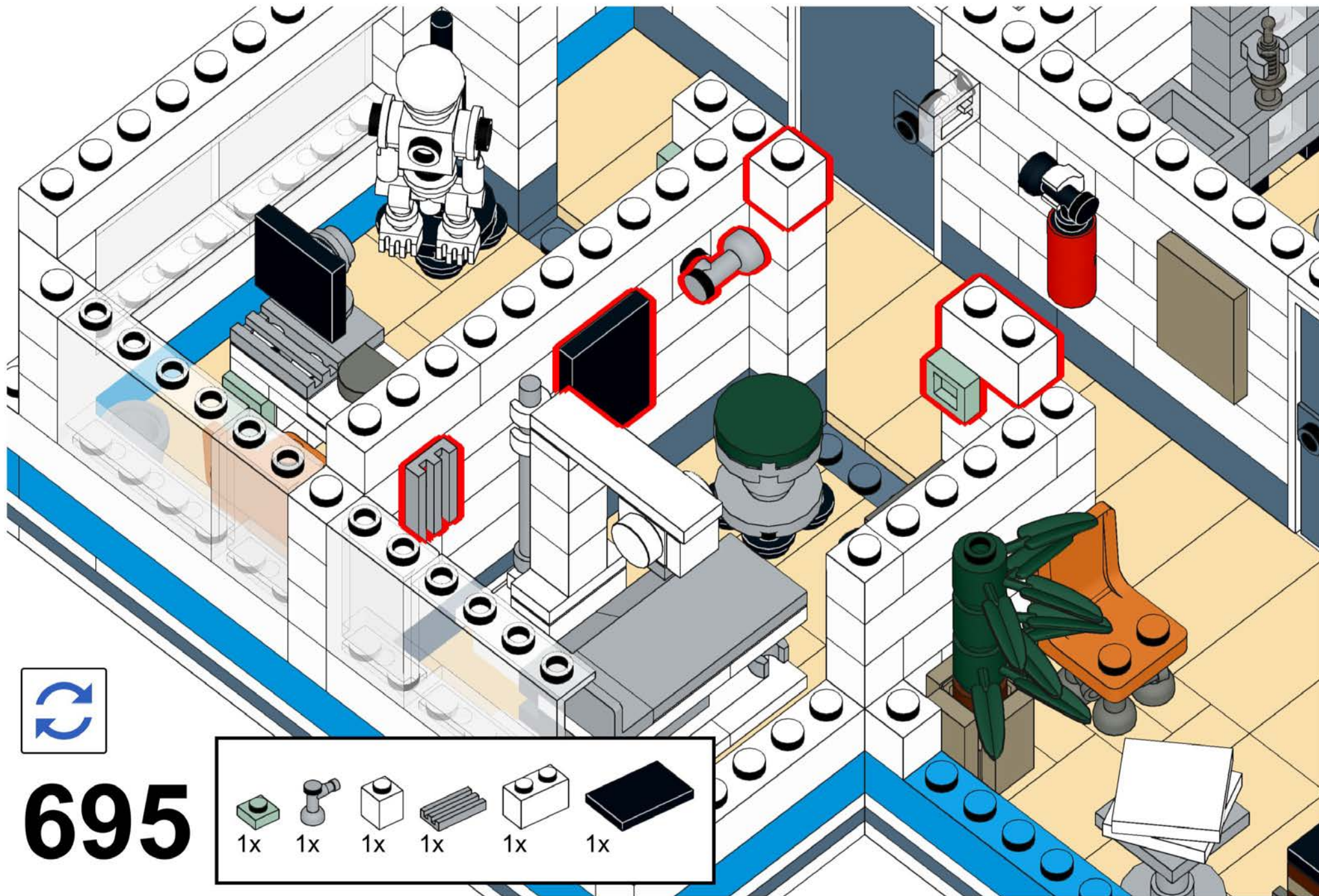

695

- 1x
- 1x
- 1x
- 1x
- 1x
- 1x

# 696

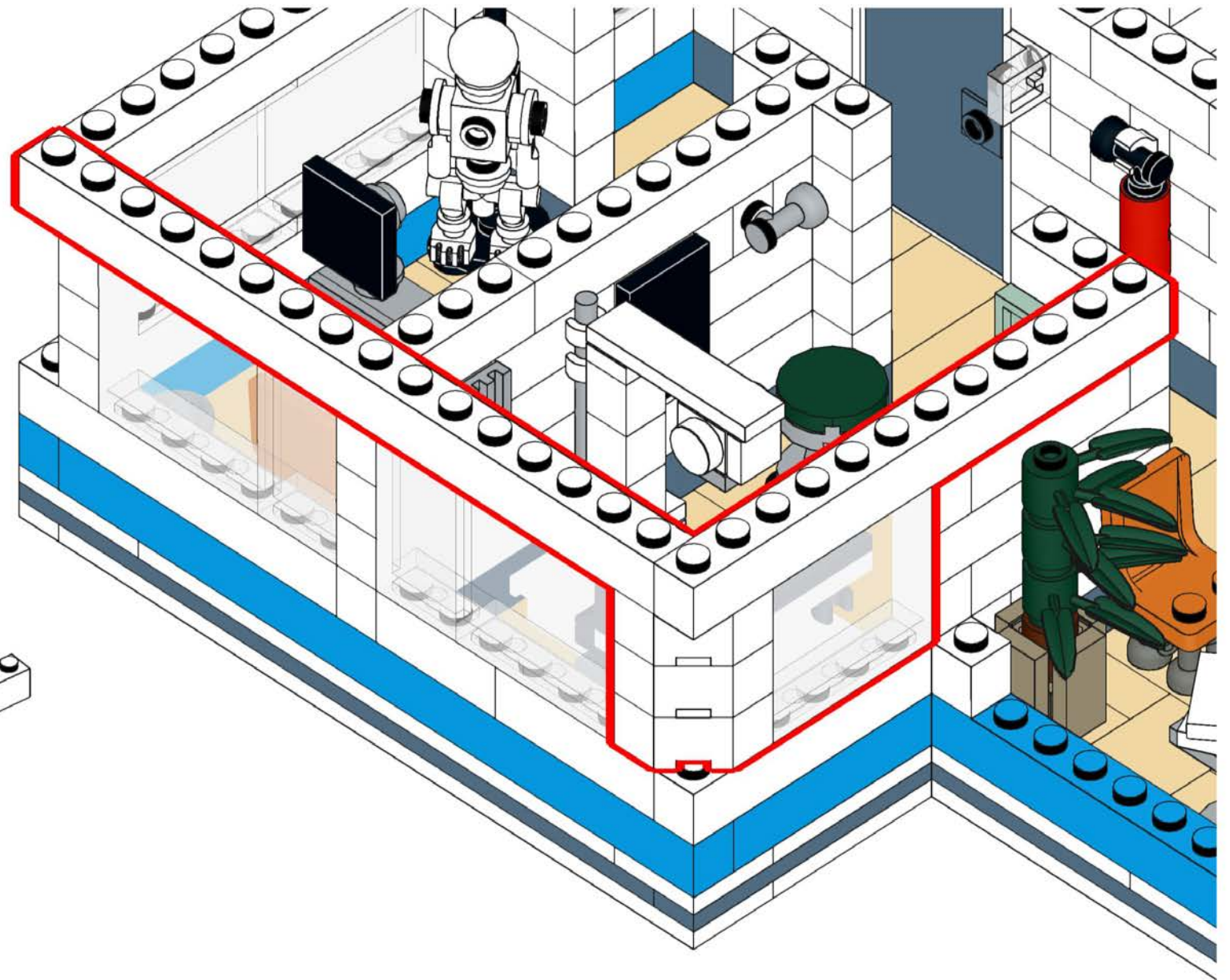
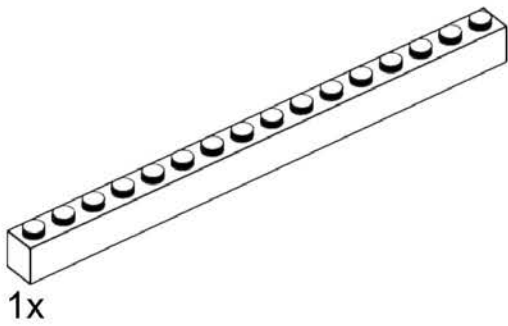
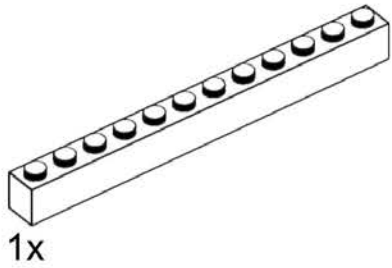
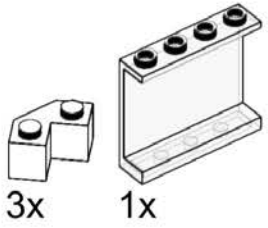

# 697

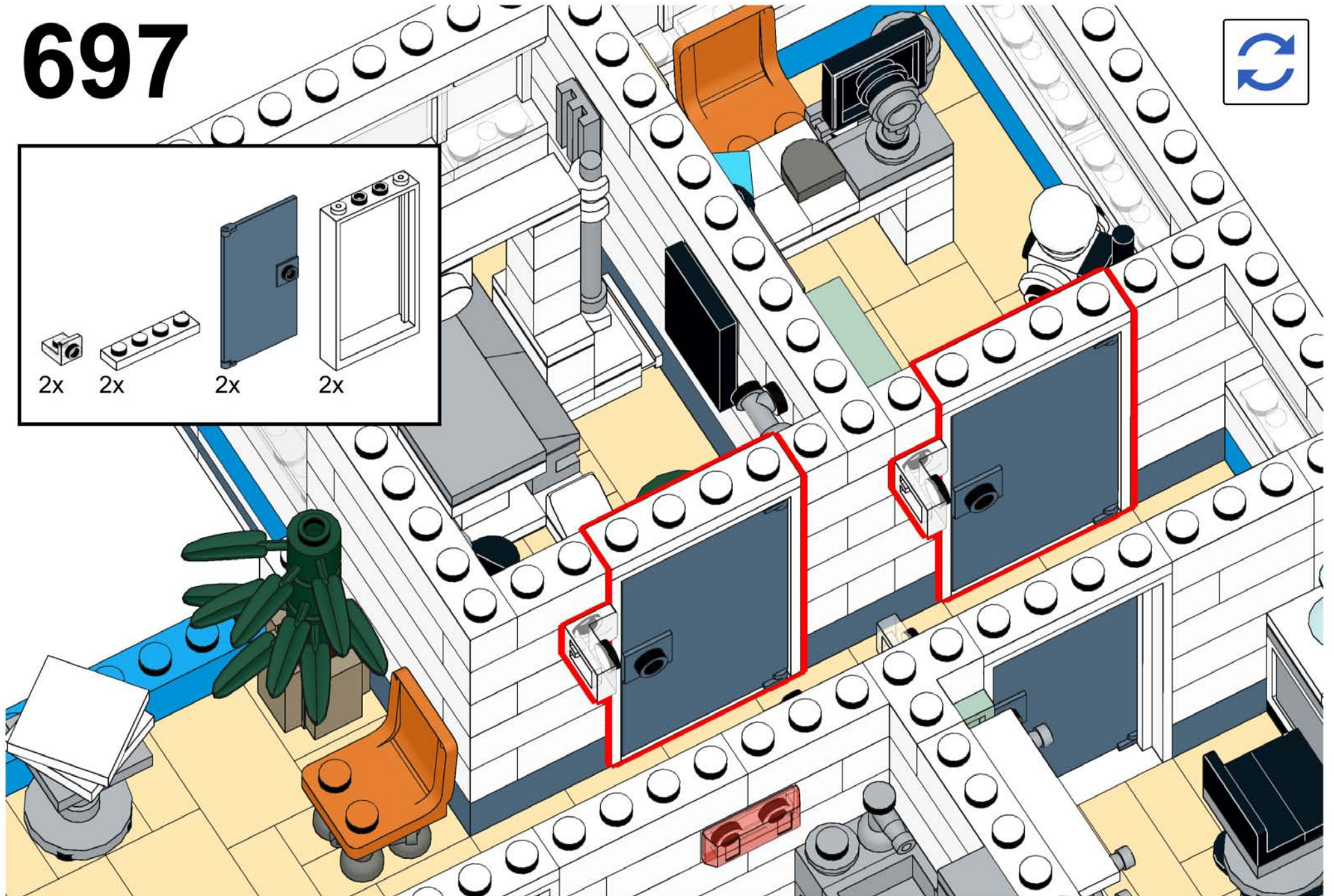
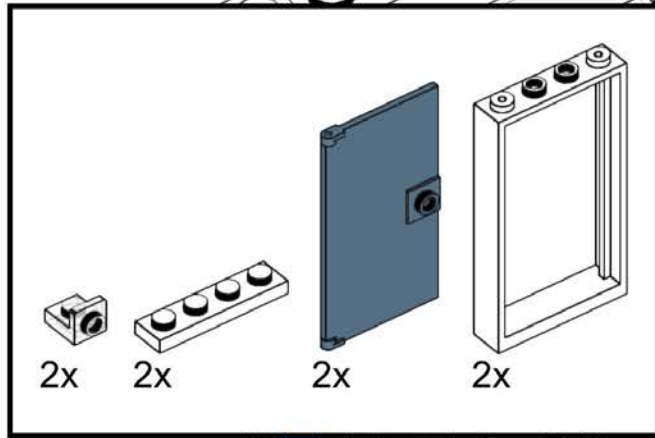

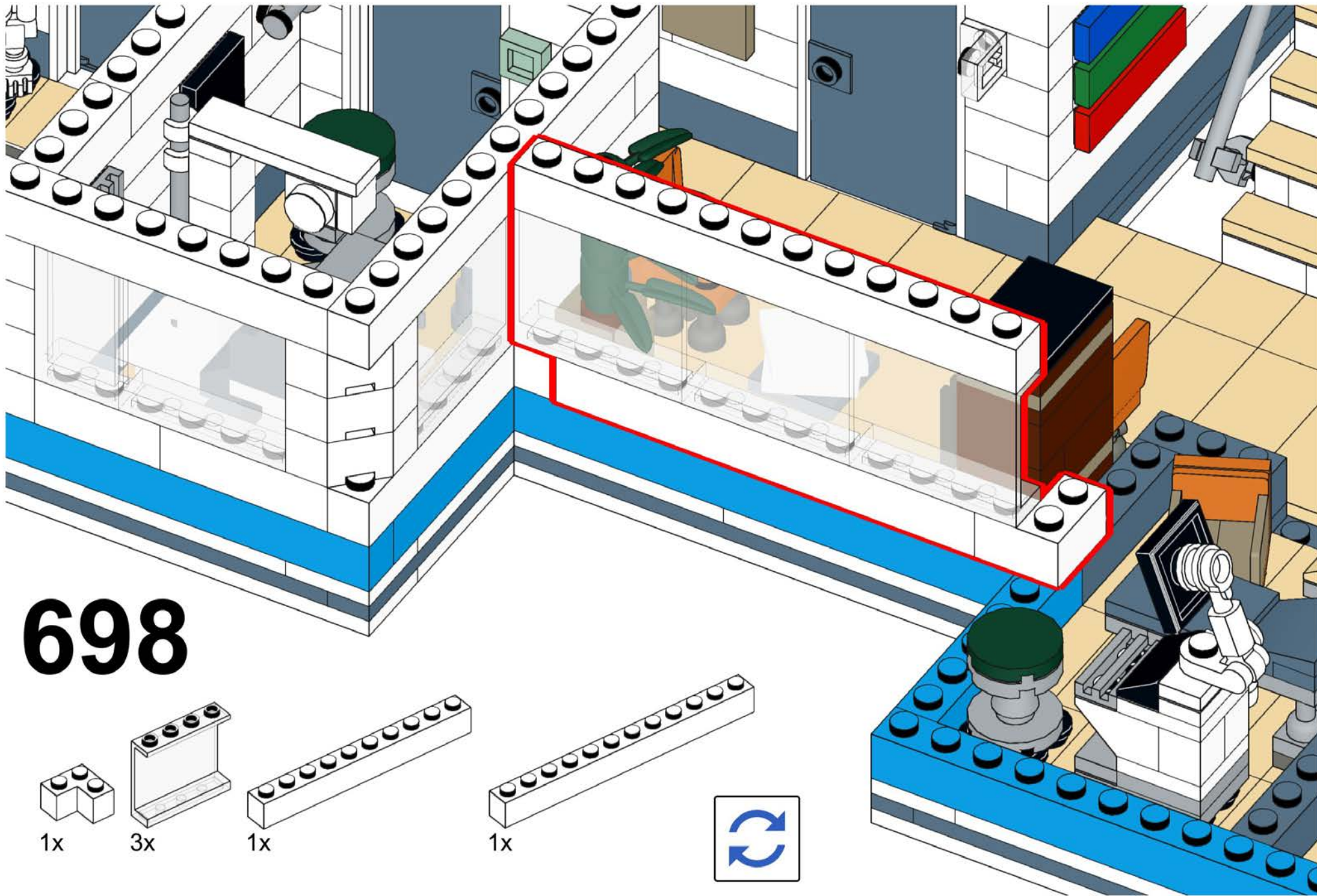

698

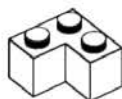

1x



3x

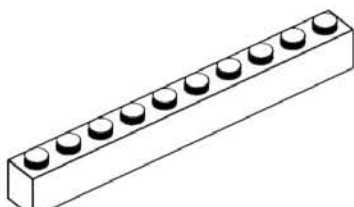

1x

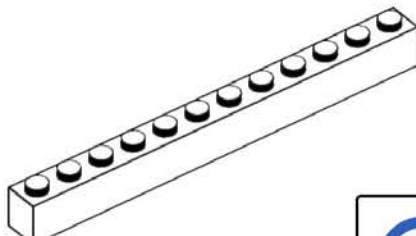

1x



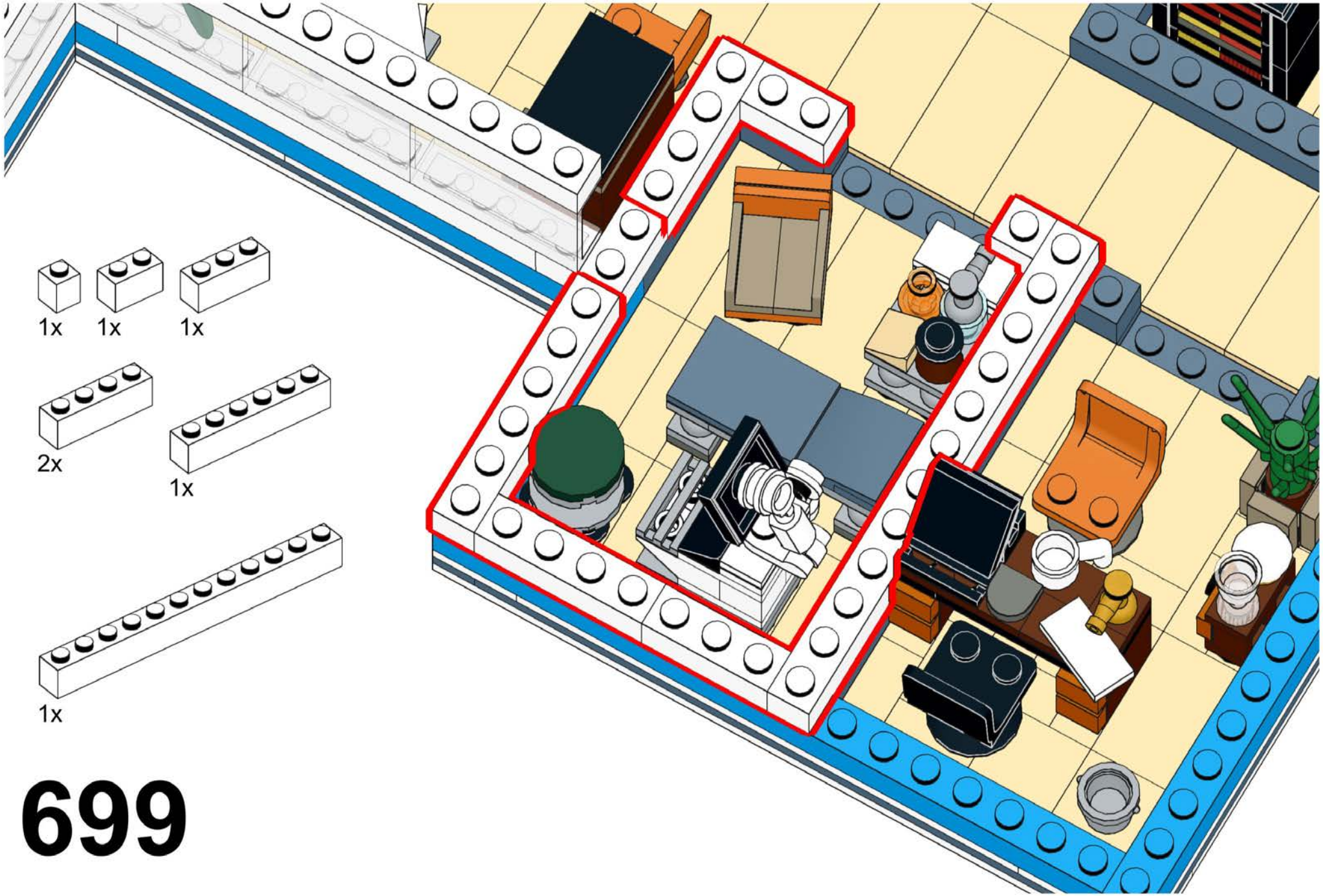

- 1x 1x1 white Technic brick
- 1x 1x2 white Technic brick
- 1x 1x3 white Technic brick

- 2x 1x4 white Technic brick
- 1x 1x6 white Technic brick

- 1x 1x10 white Technic brick

699

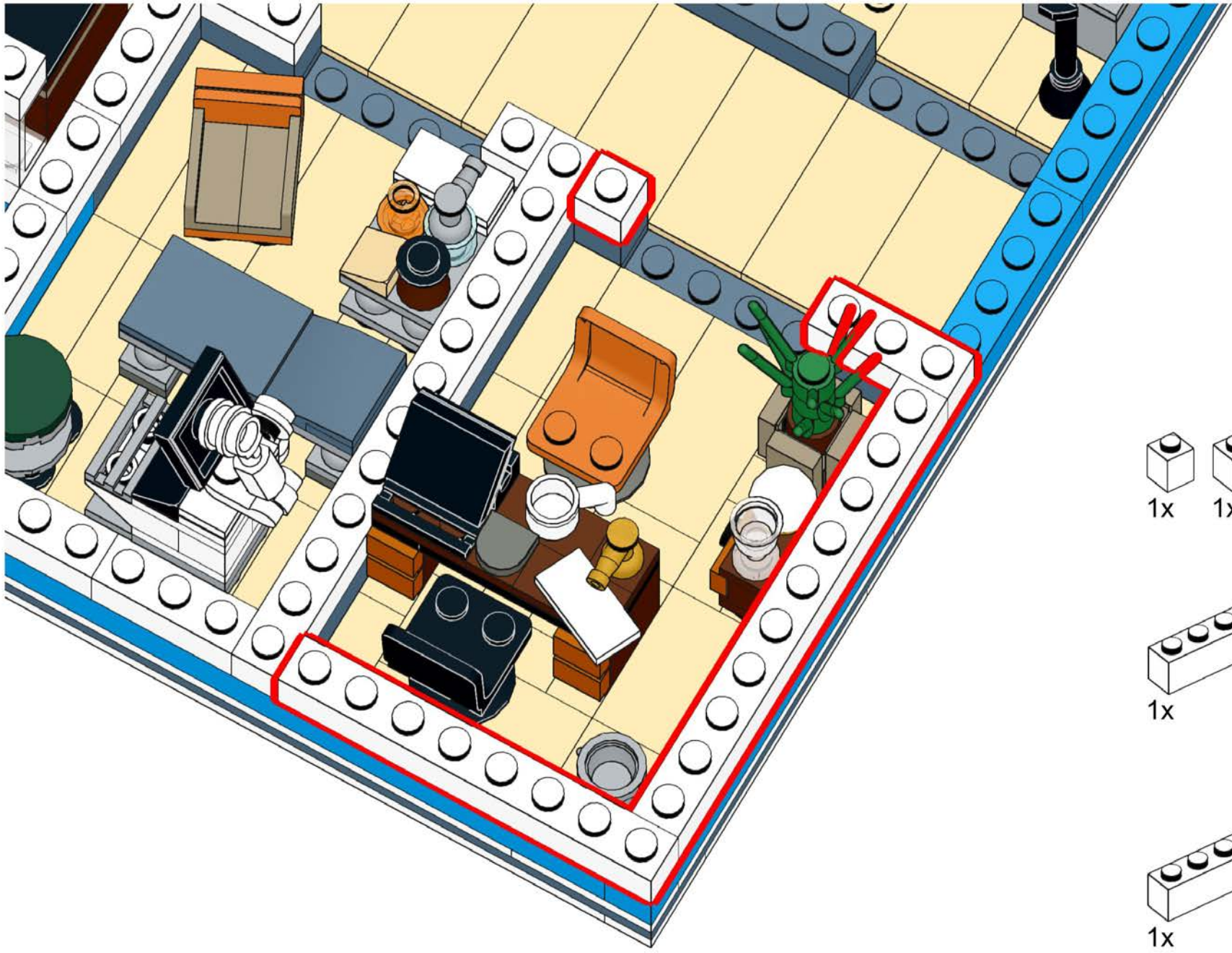

700

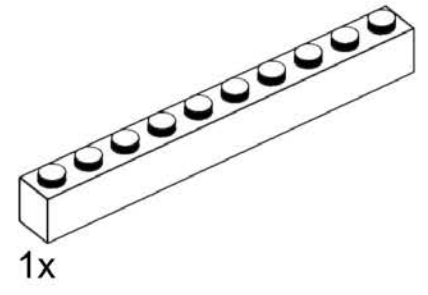
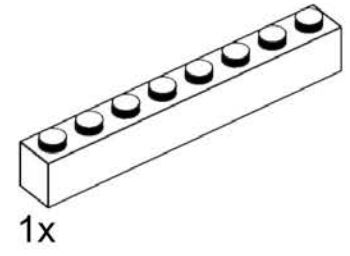
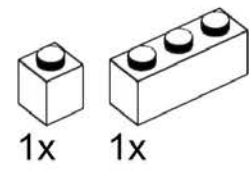



# 701

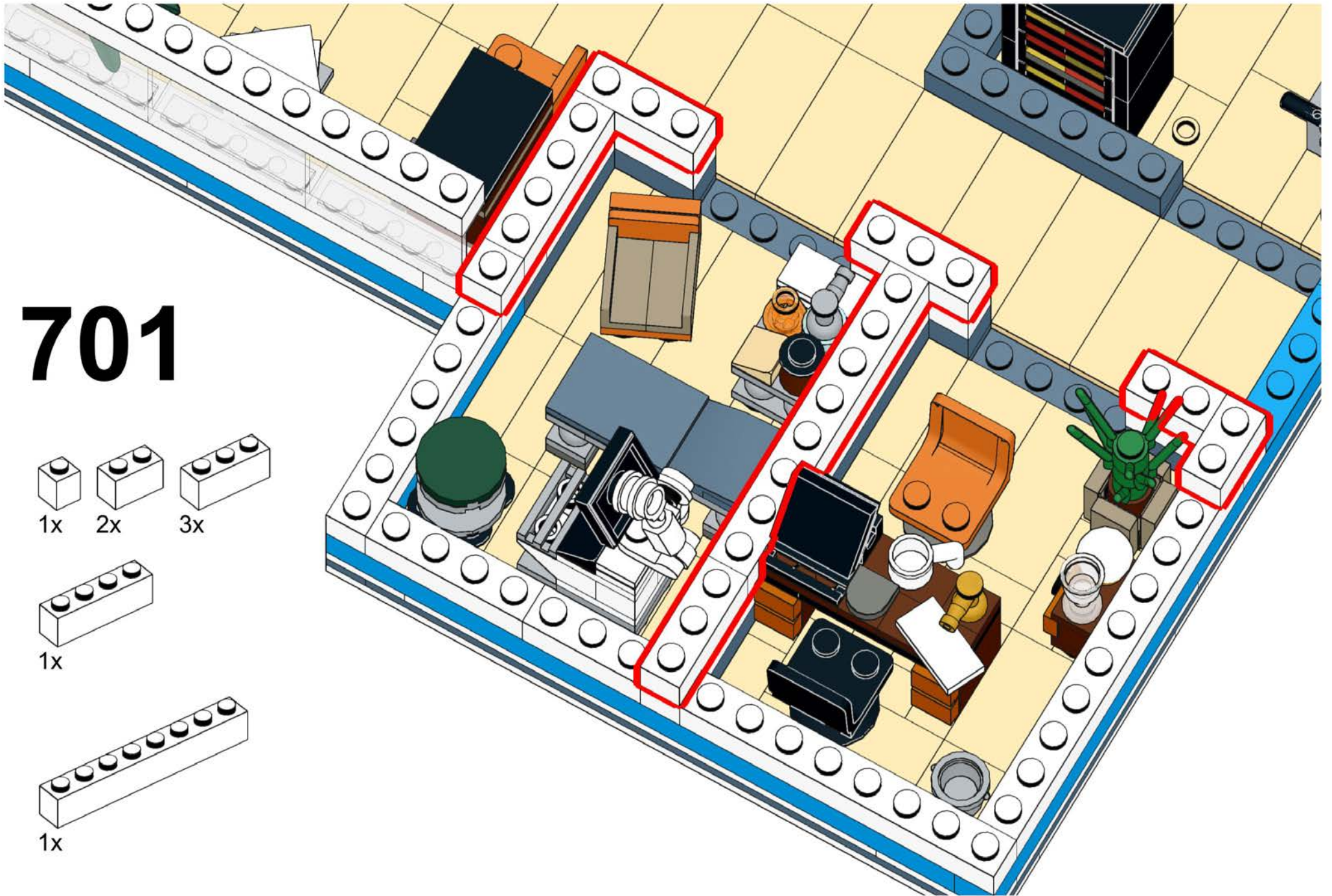
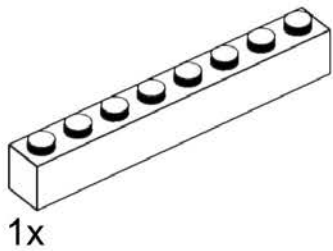
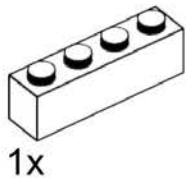
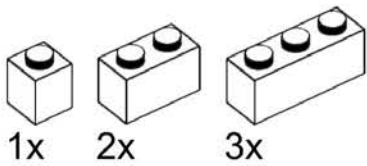

# 702

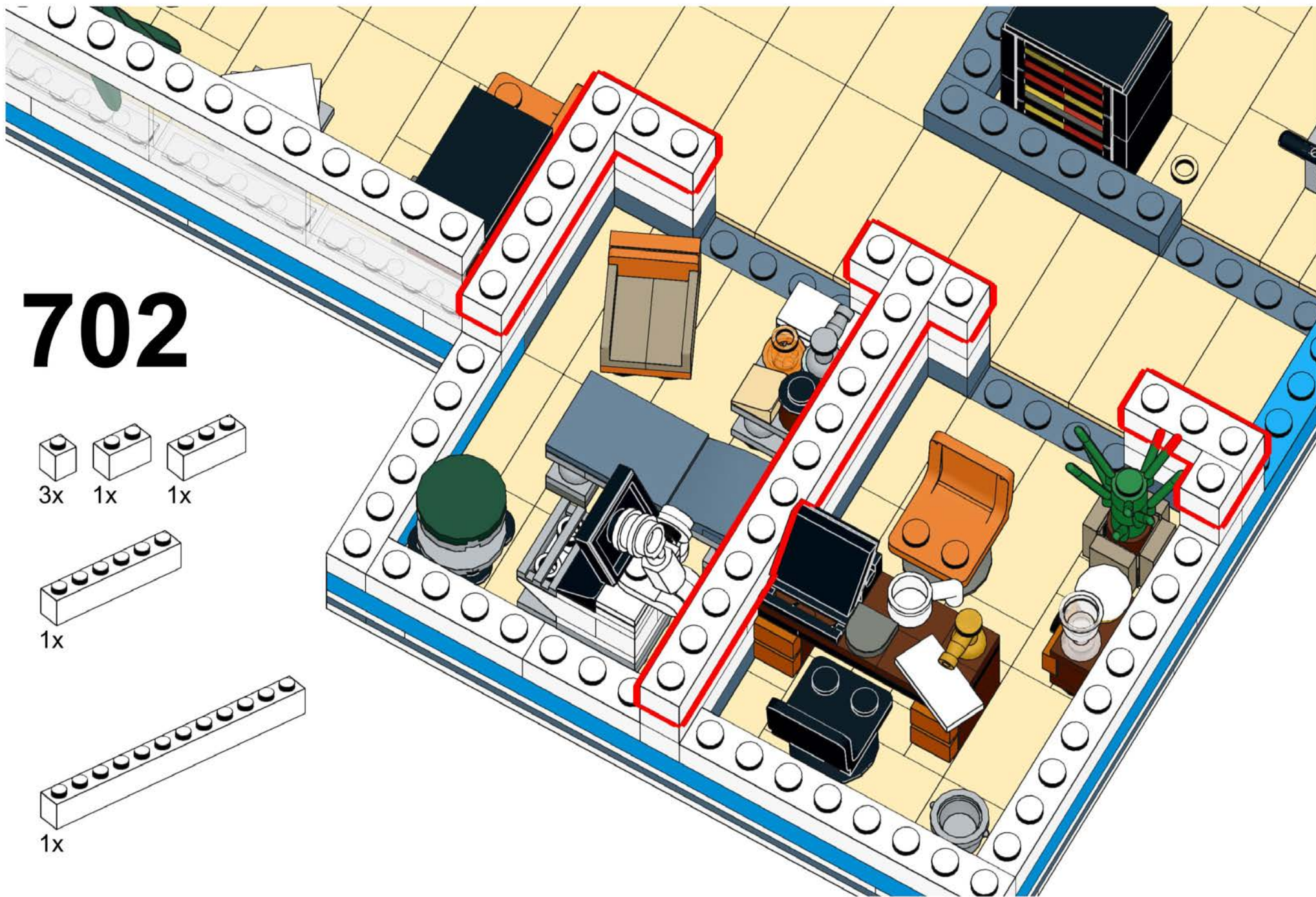
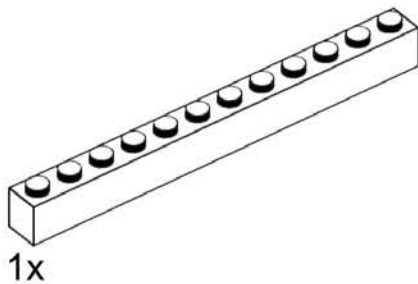
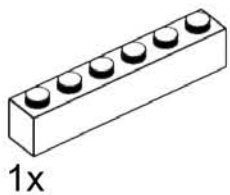
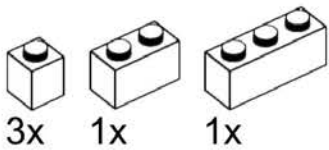

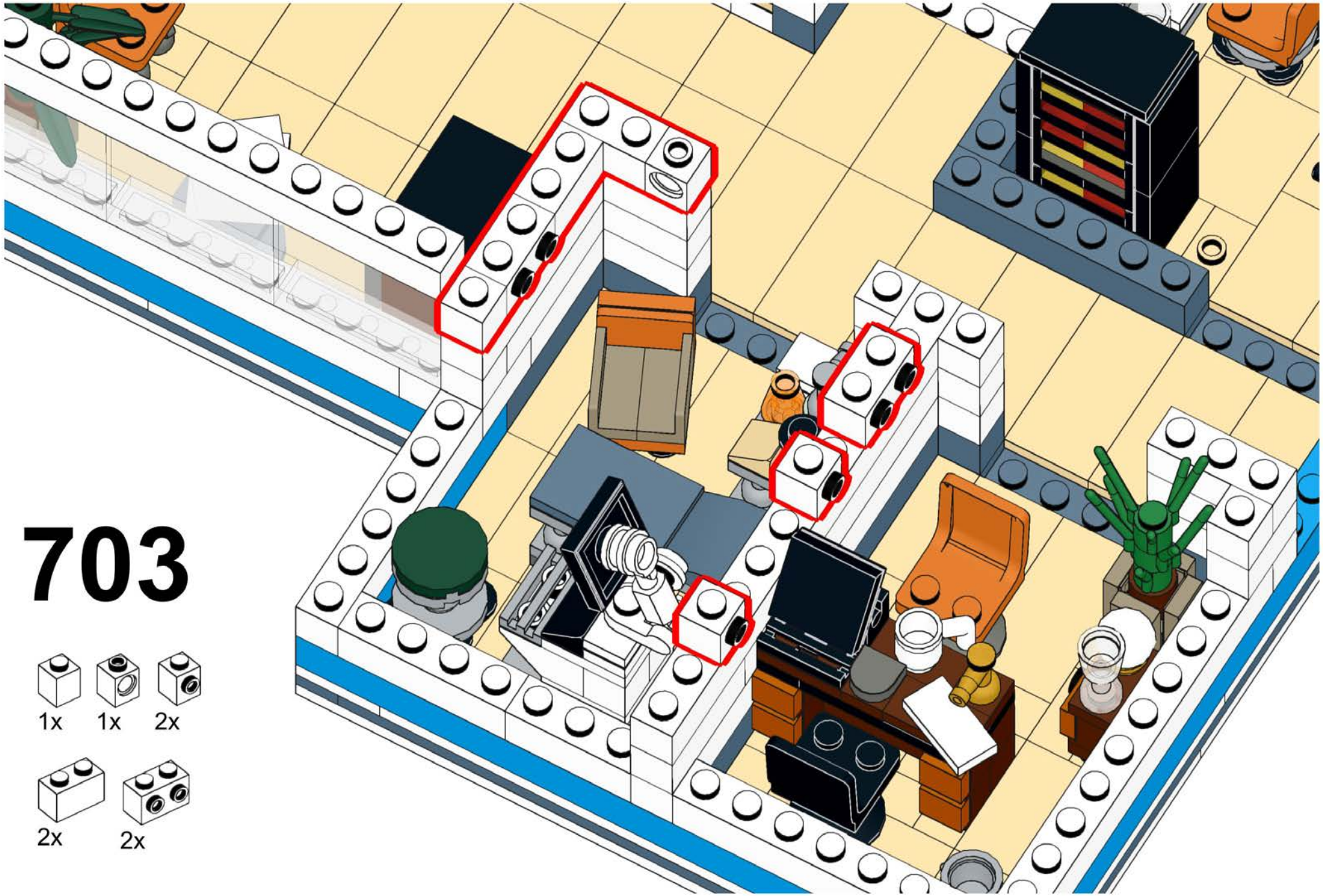

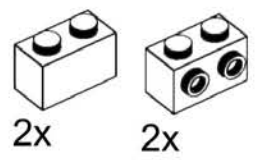
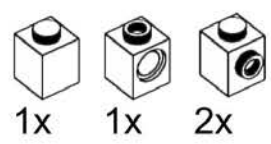

# 703

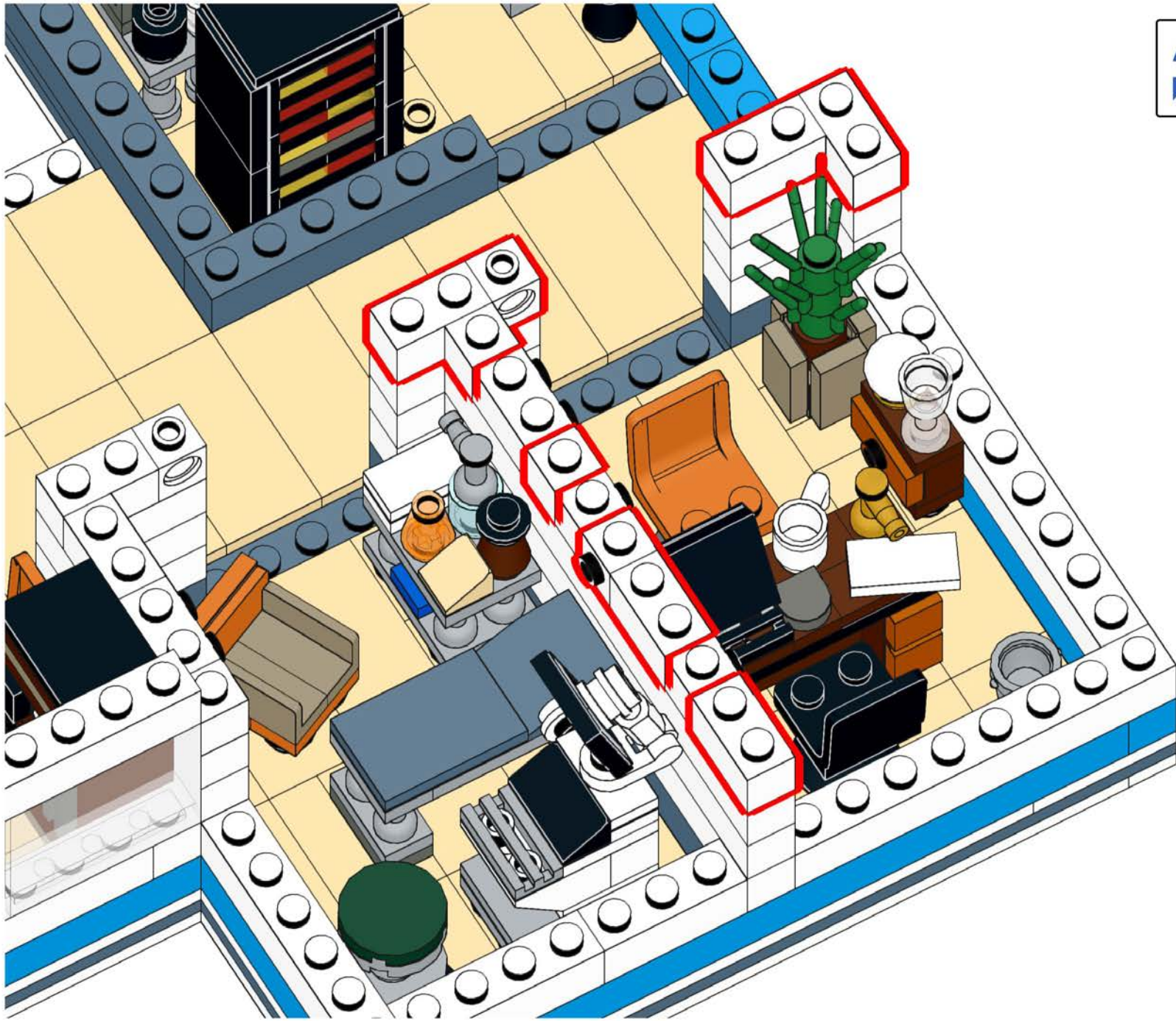

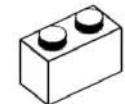

# 704

-  2x
-  1x
-  1x
-  5x

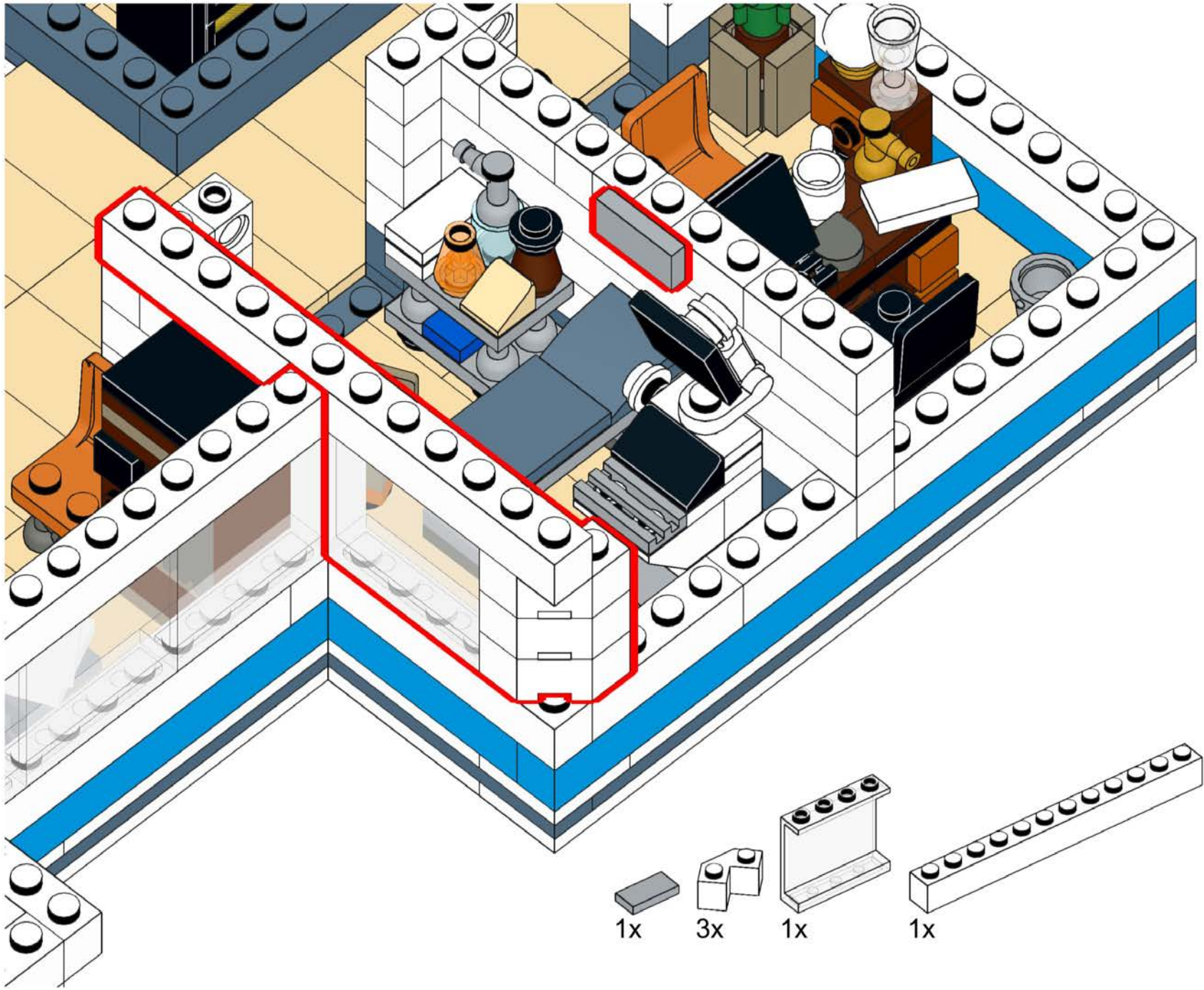

1x

3x

1x

1x

# 705

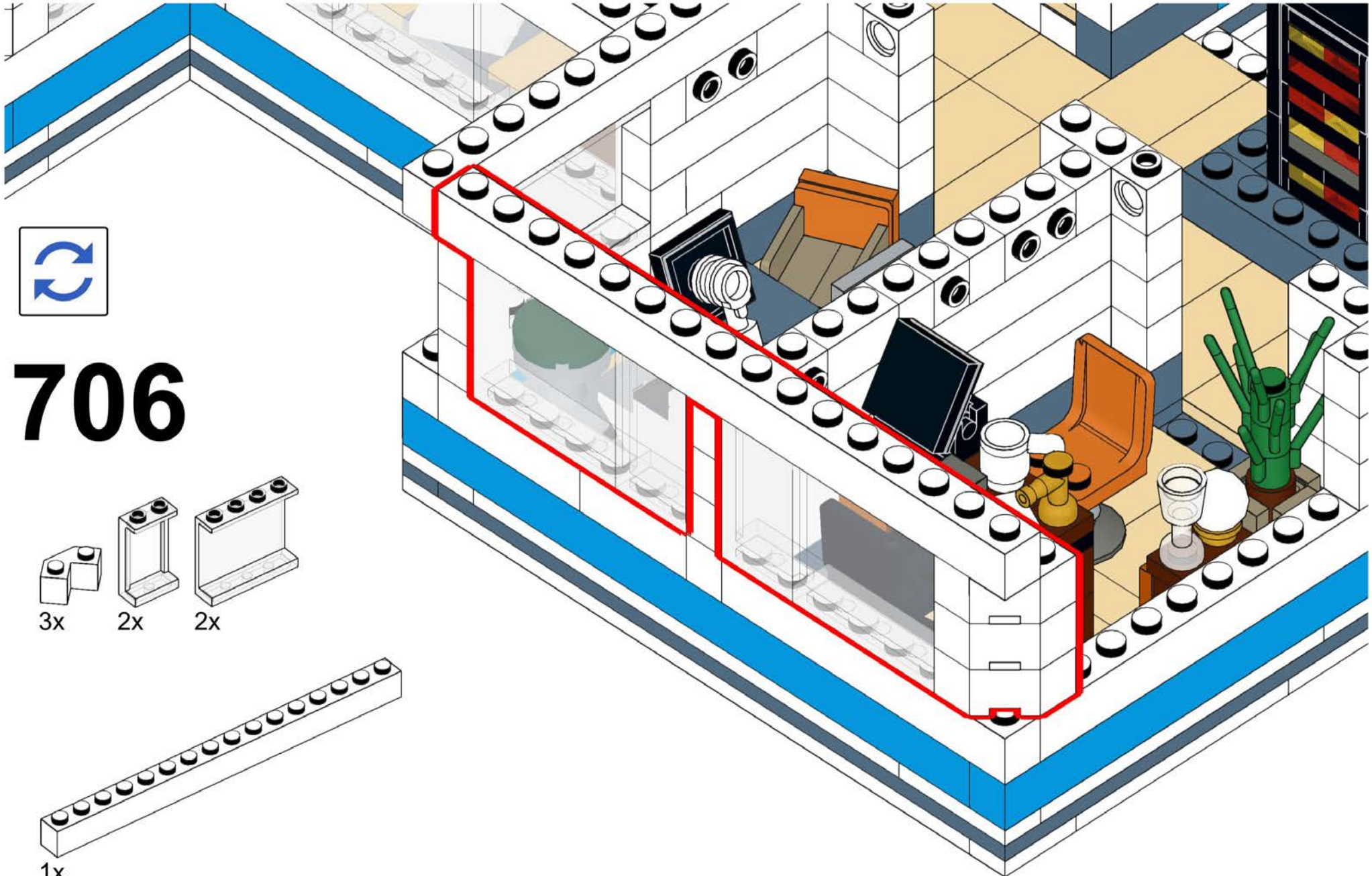

706

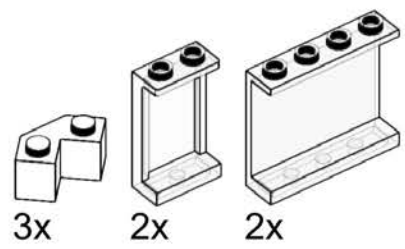

3x

2x

2x

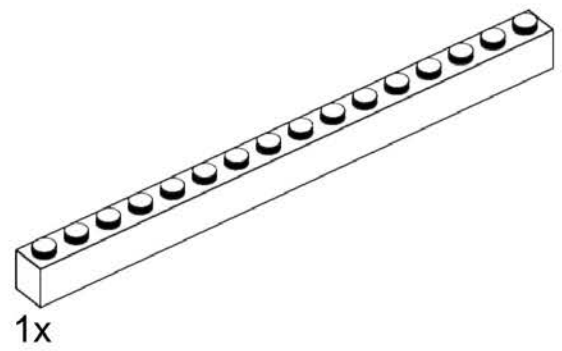

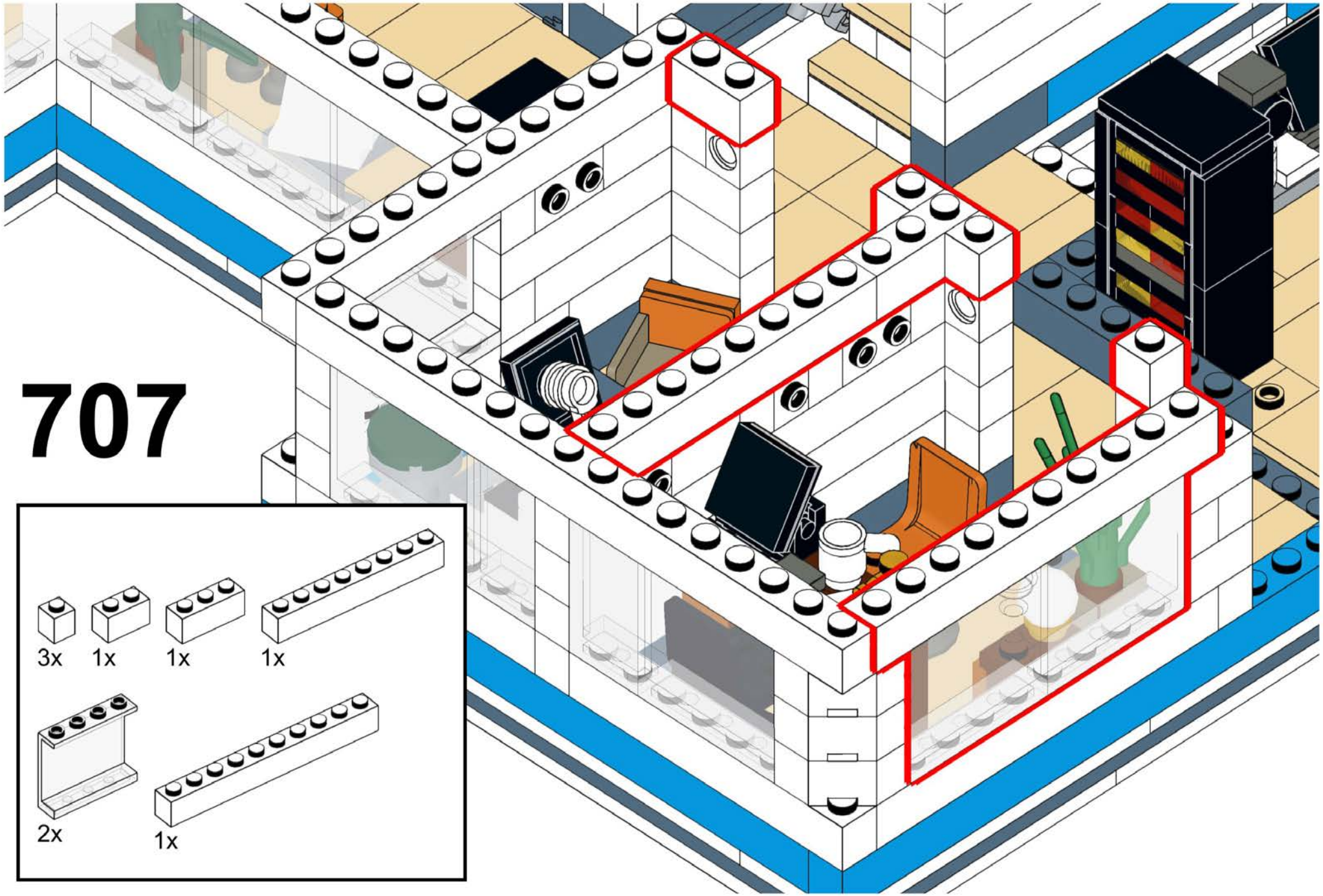

1x

# 707

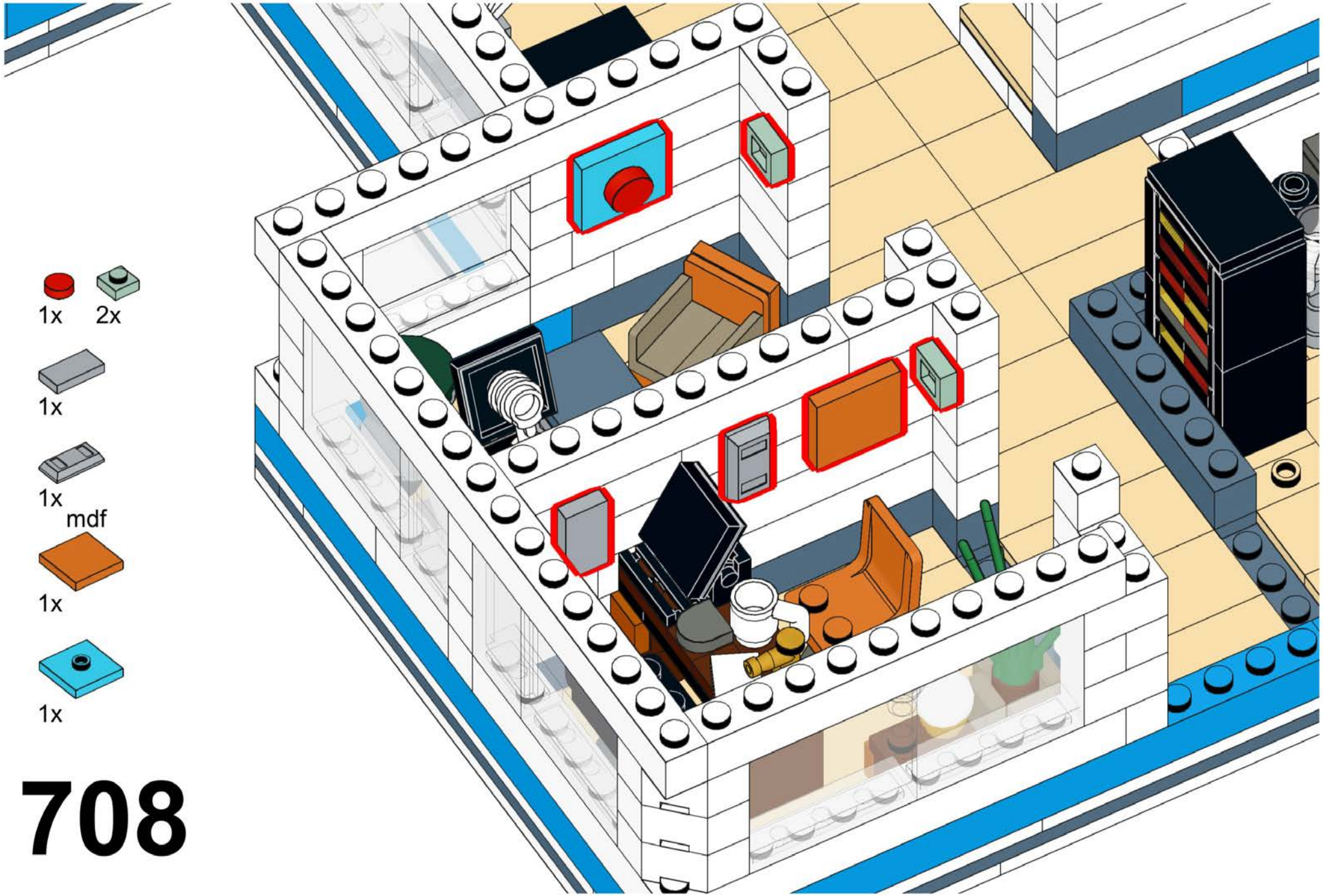





1x  2x 

1x 

1x  mdf

1x 

1x 

# 708





709

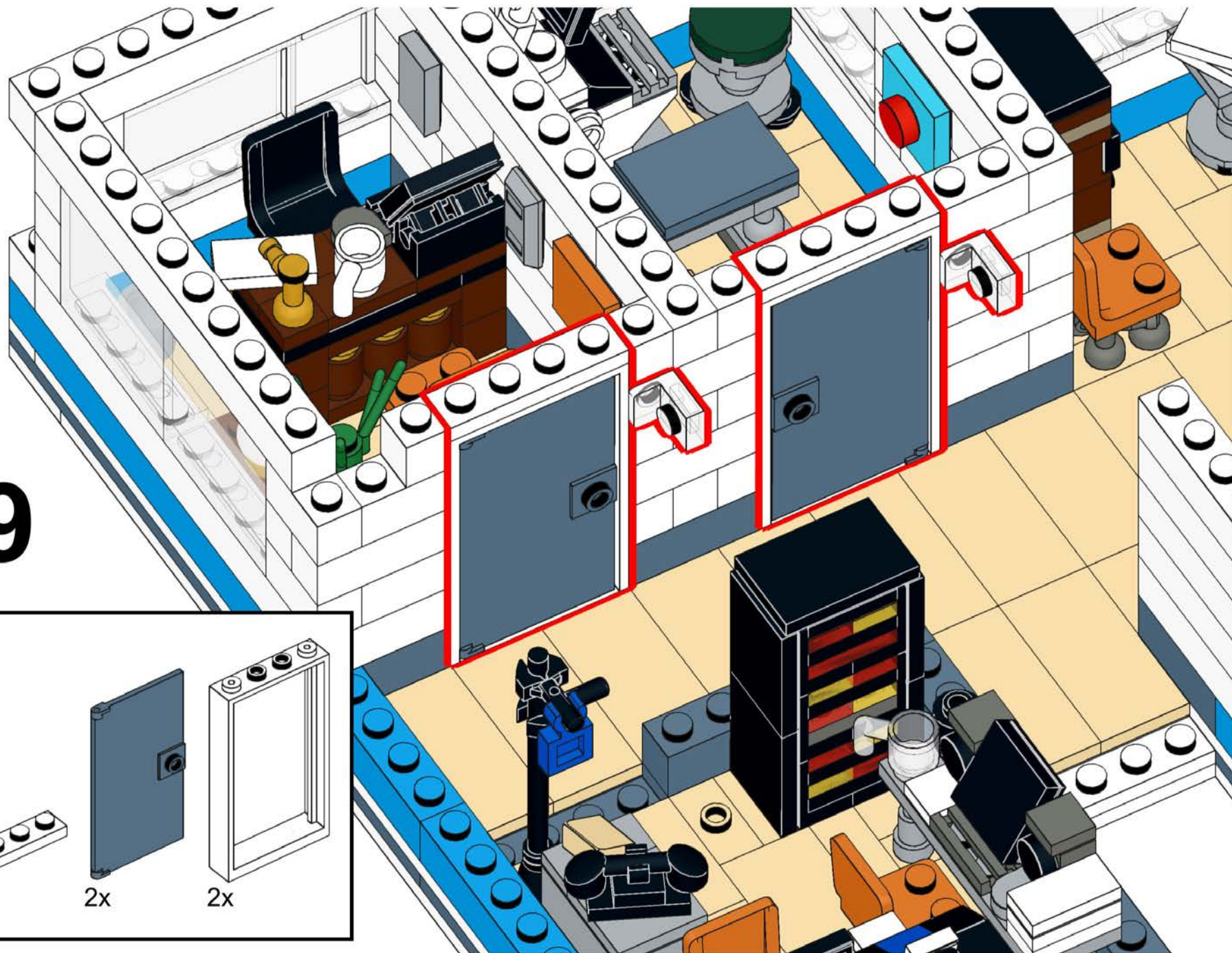
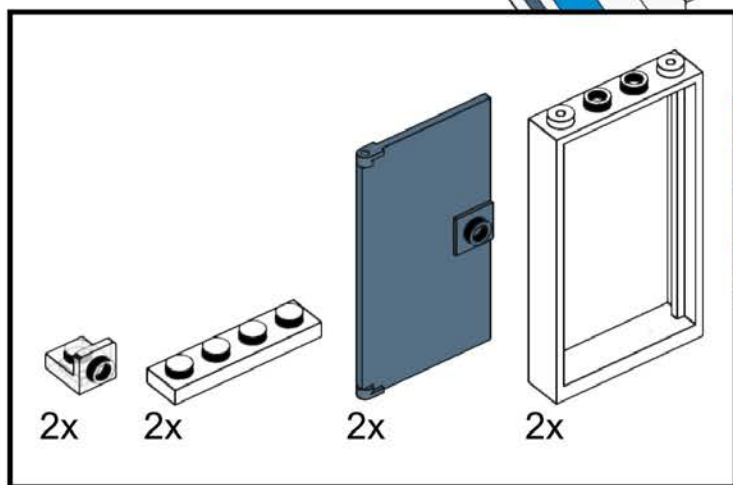

# 710

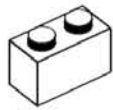

1x

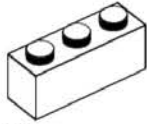

2x

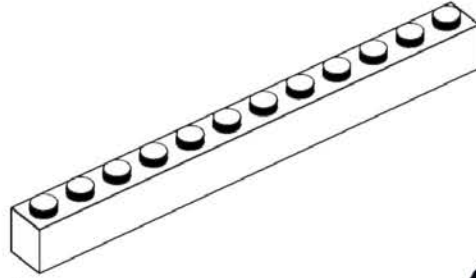

1x

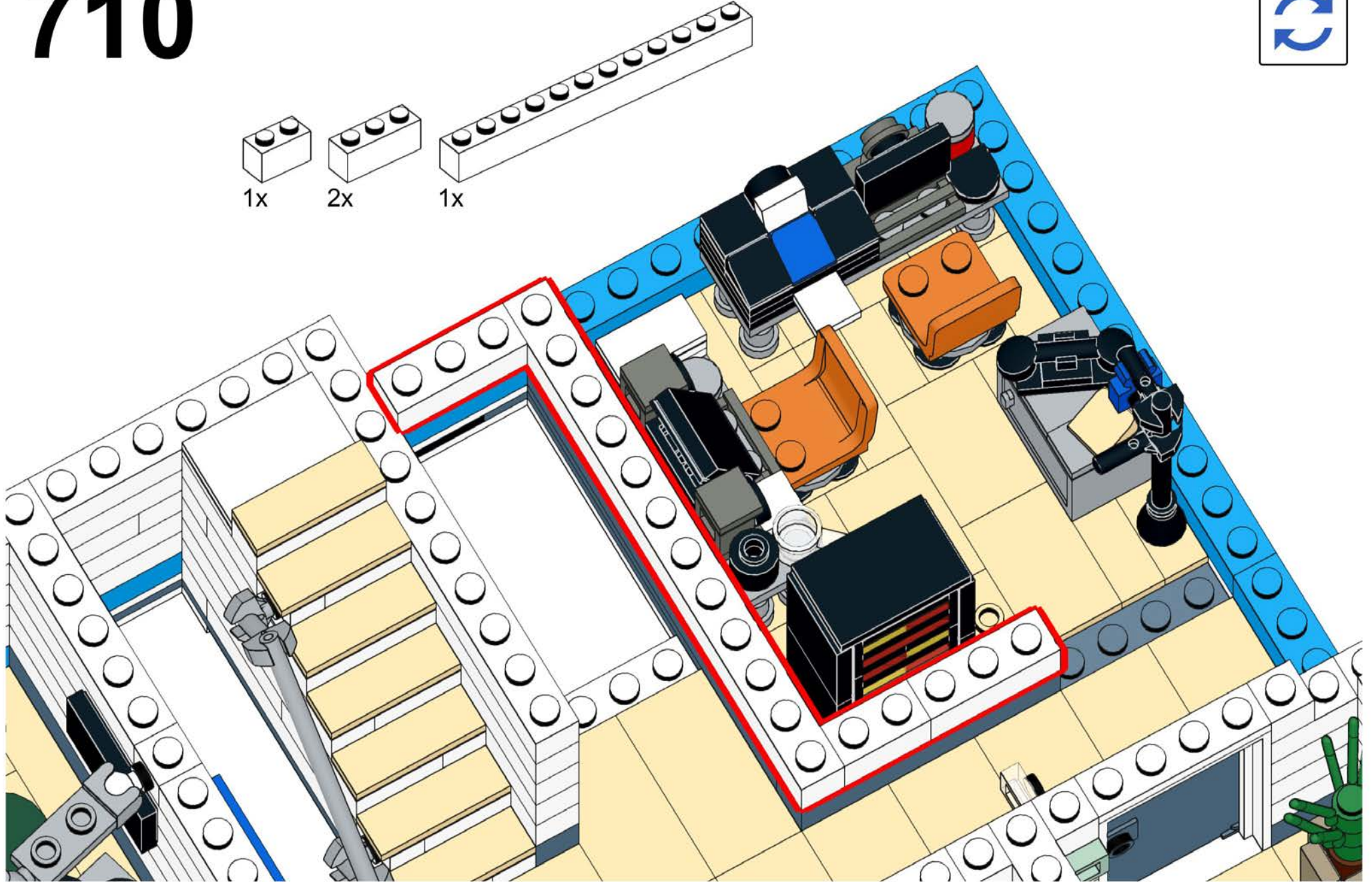

# 711

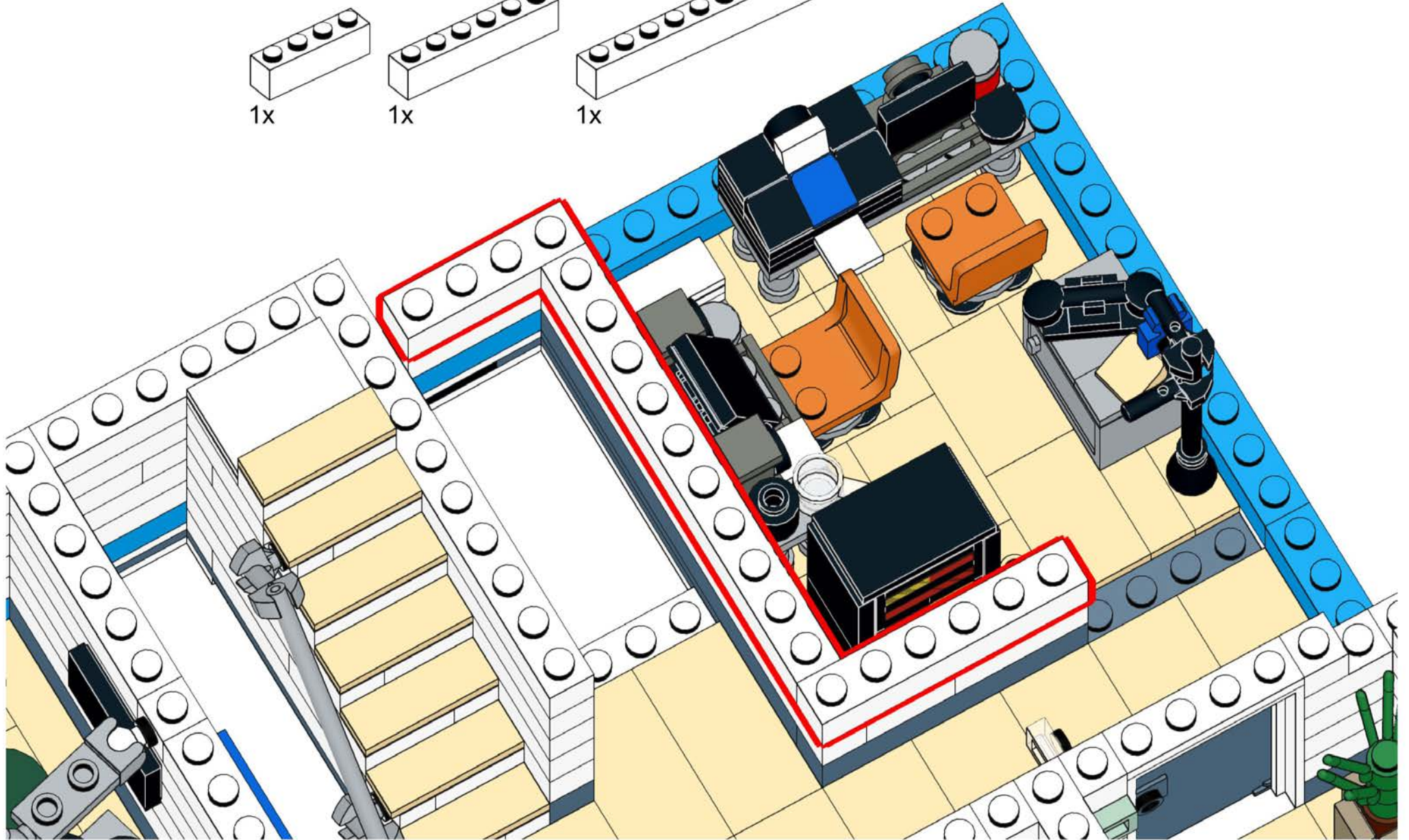
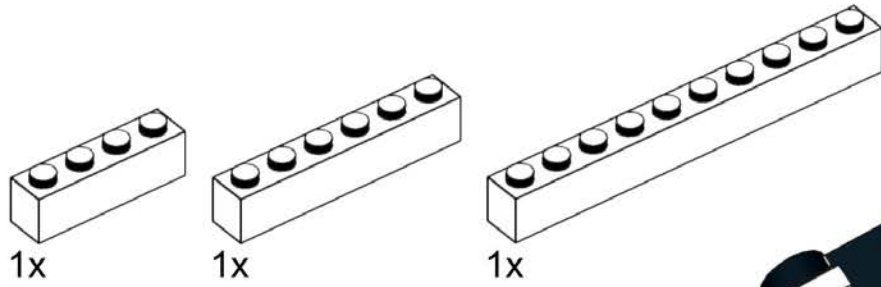

# 712

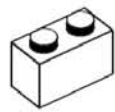

1x

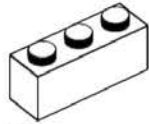

2x

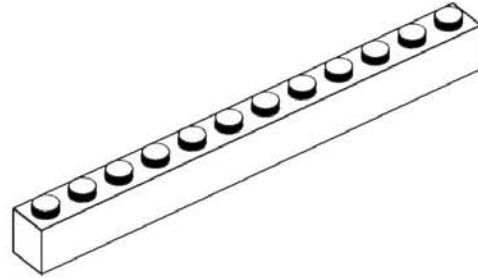

1x

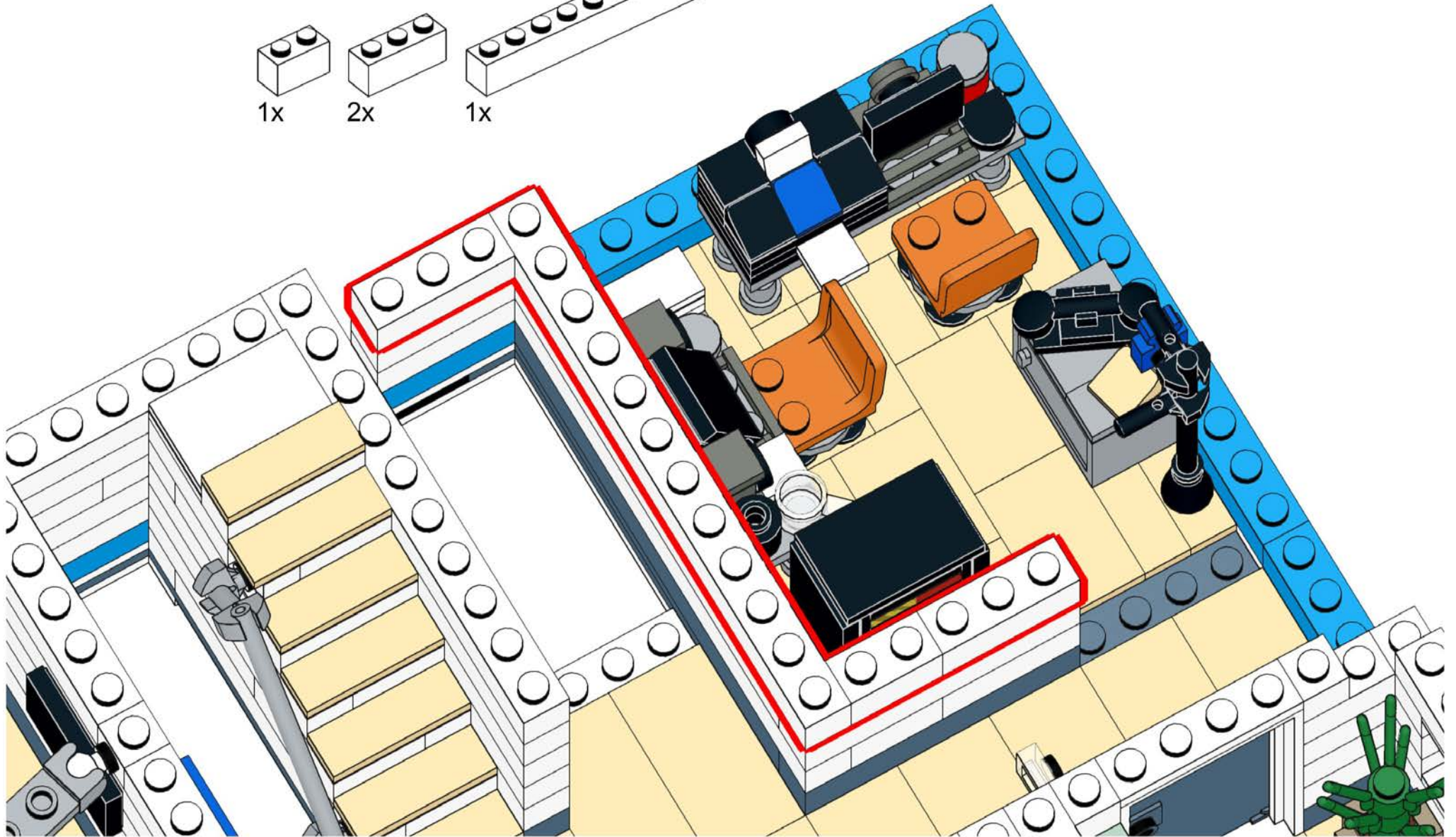

# 713

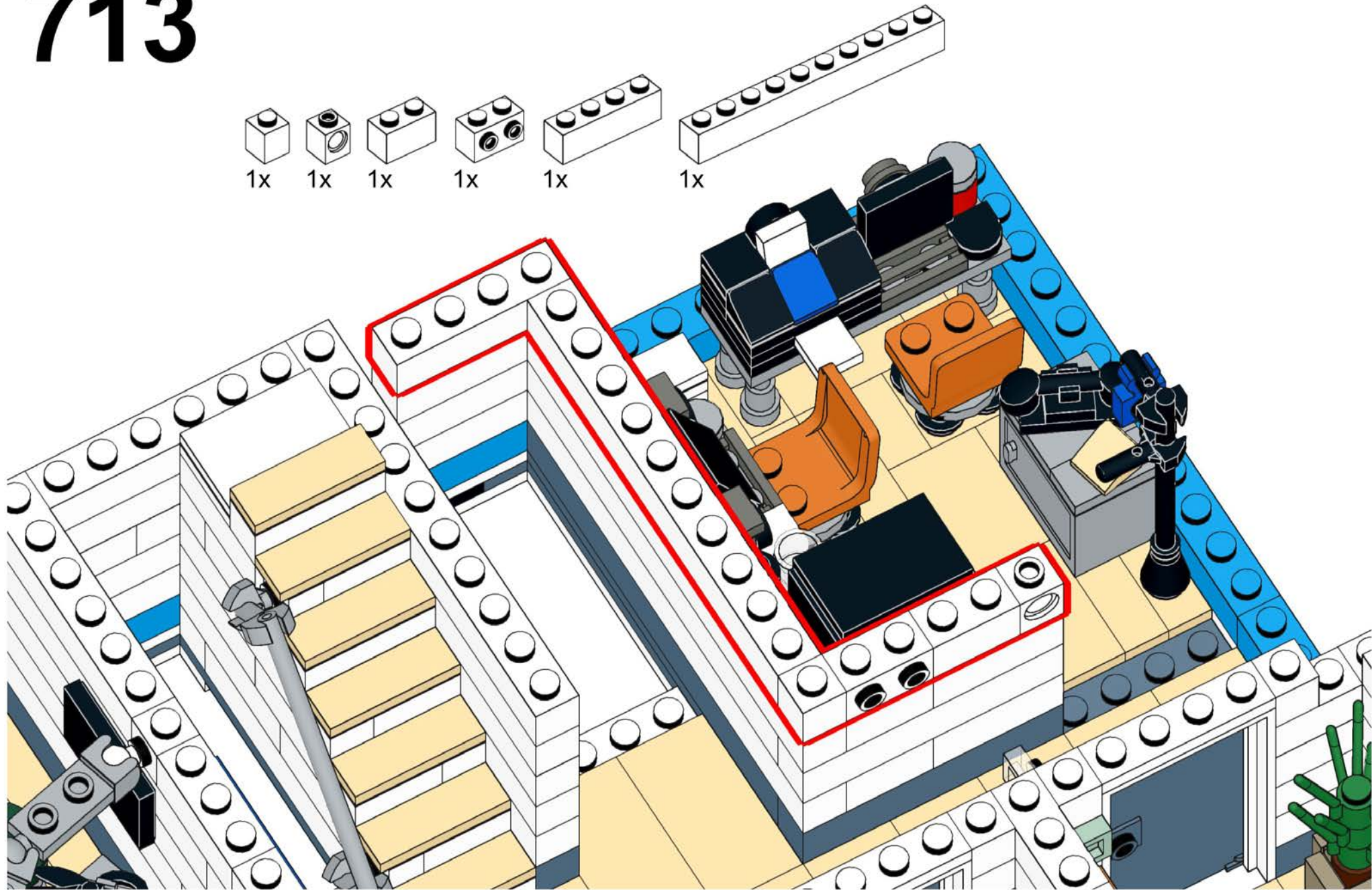
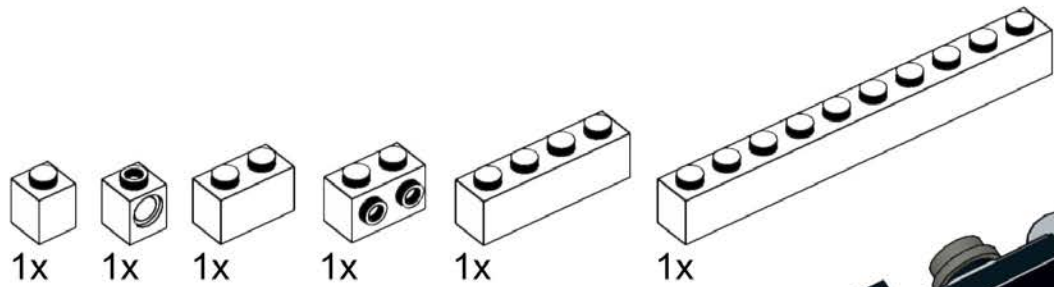

# 714

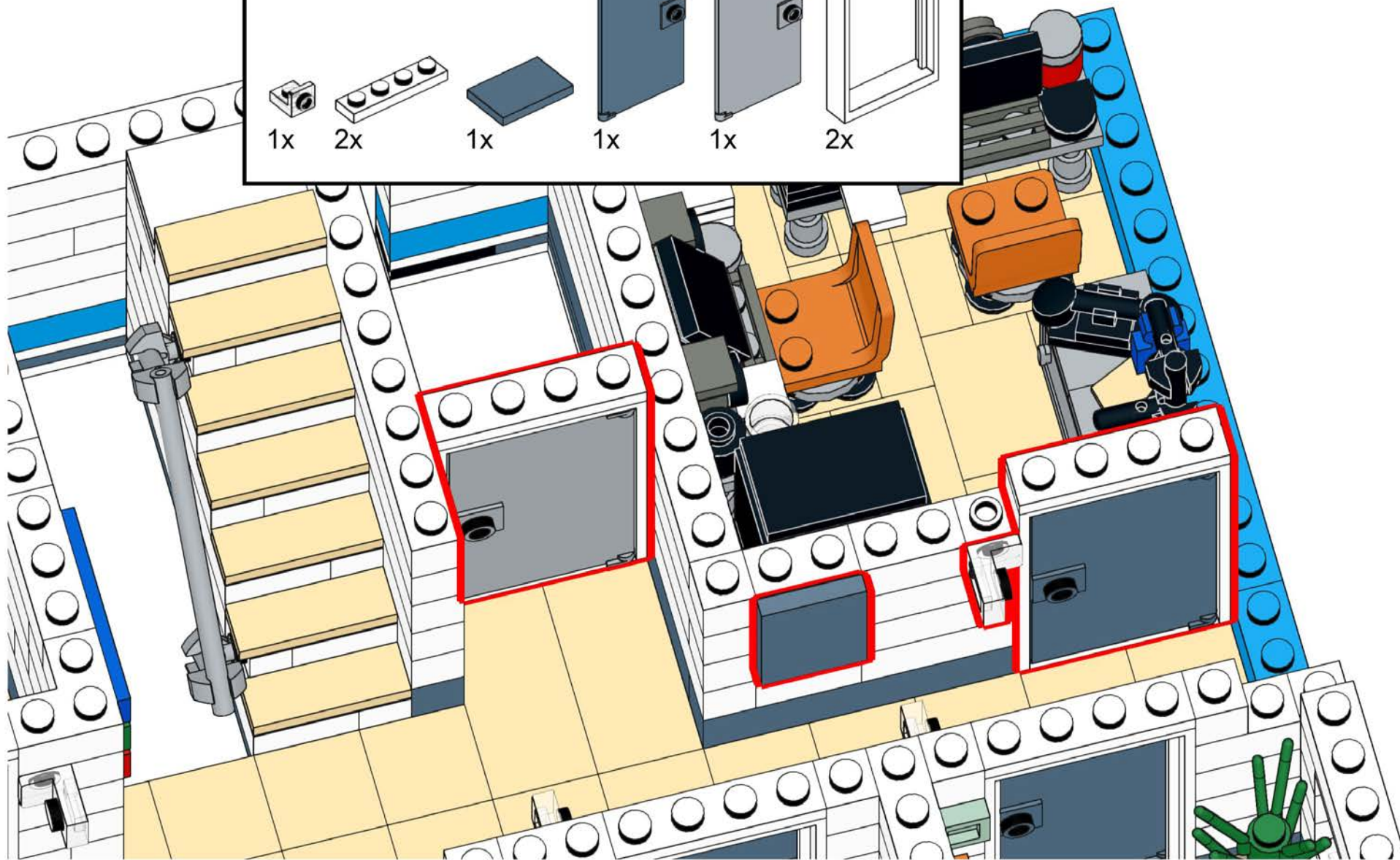
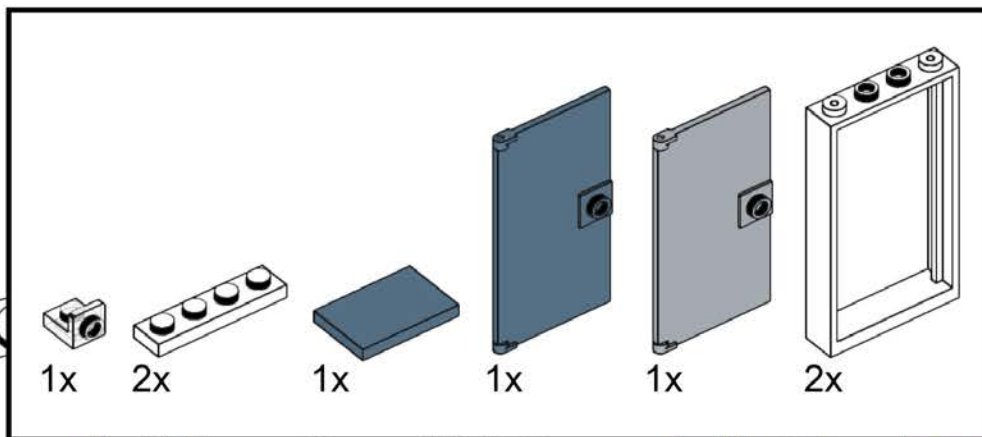

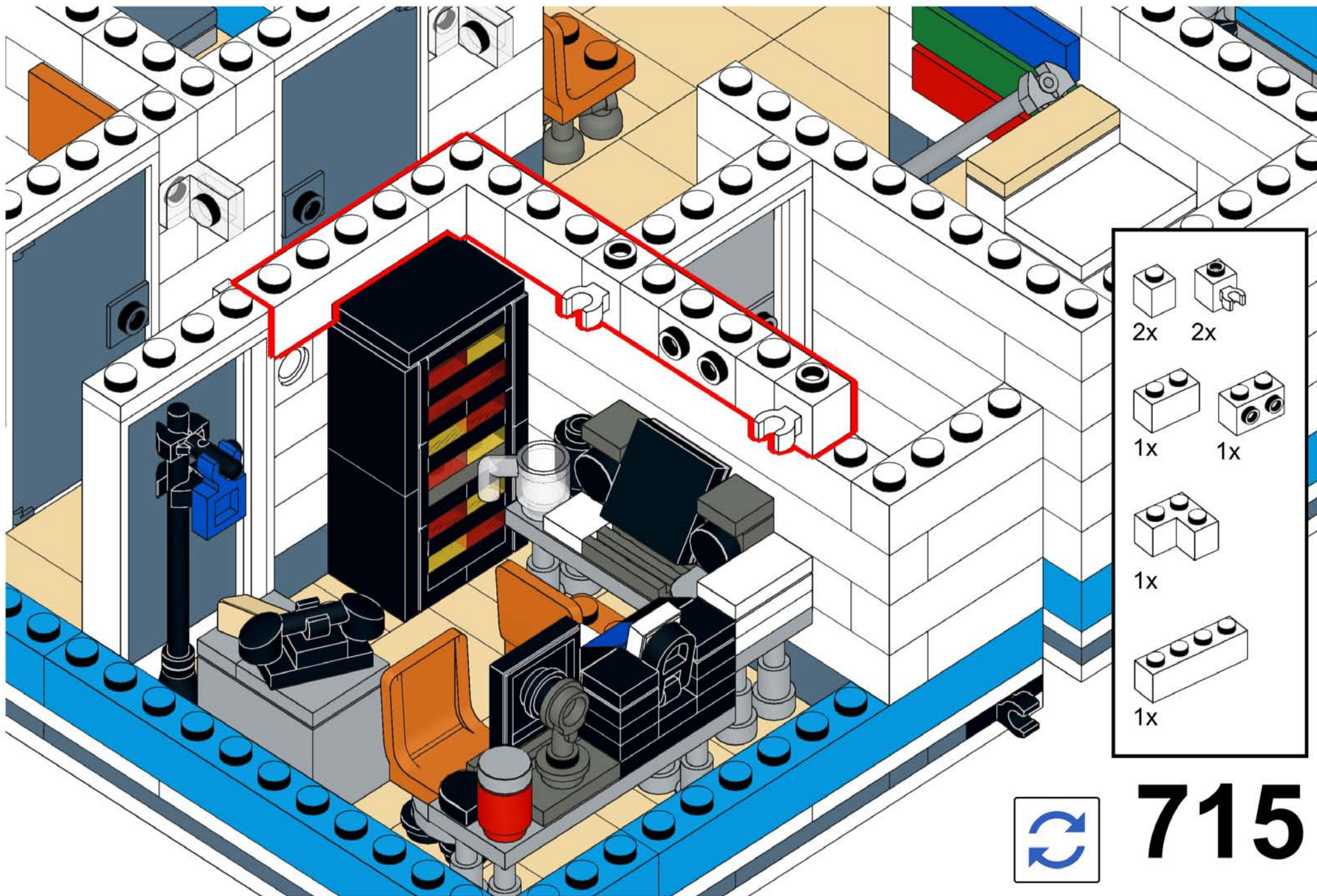

2x 2x

1x 1x

1x

1x



# 715

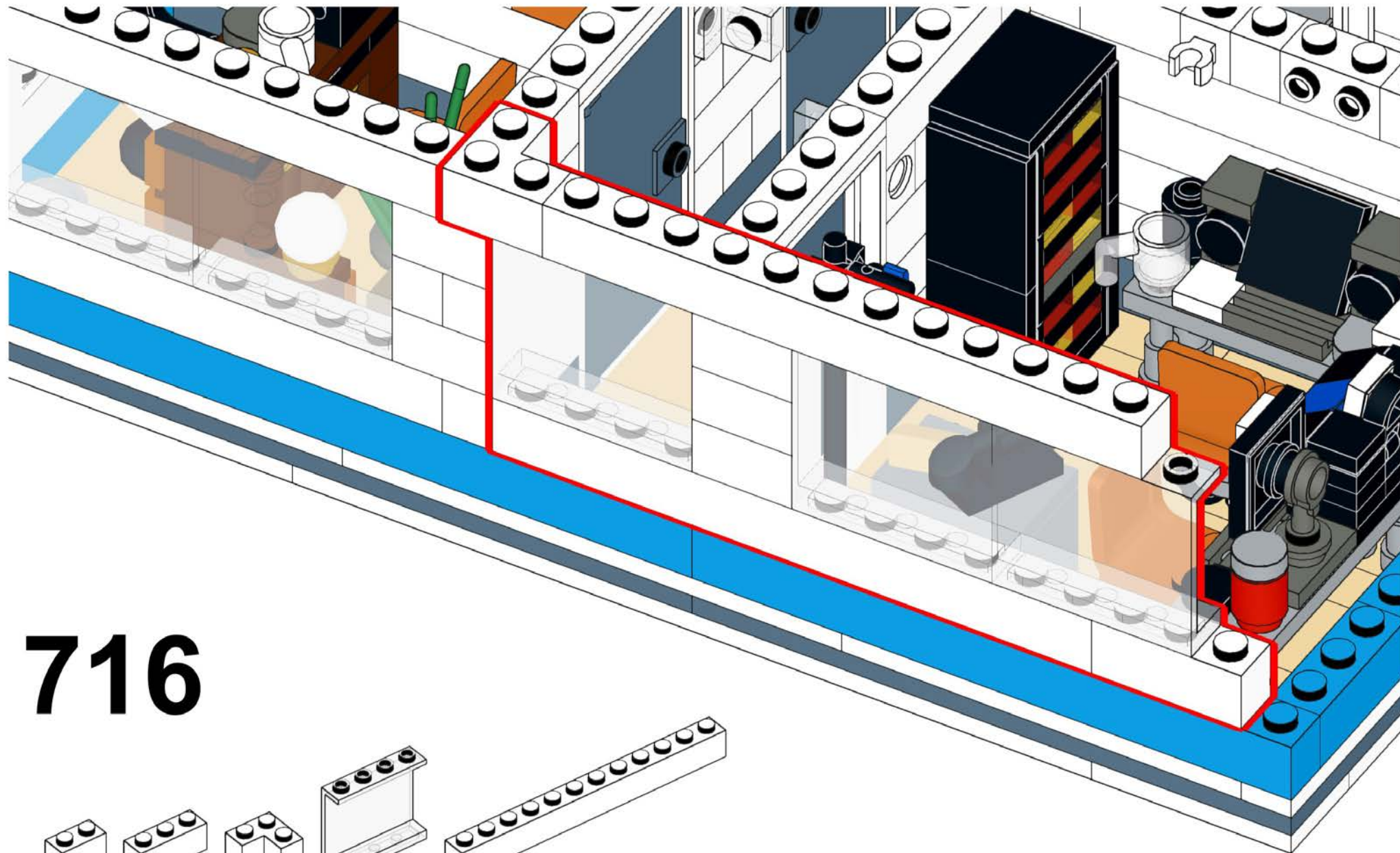

# 716

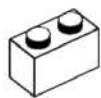

3x

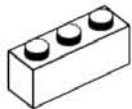

1x

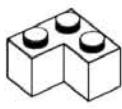

1x



3x

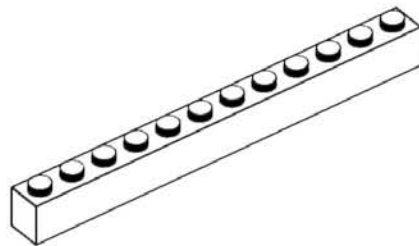

2x



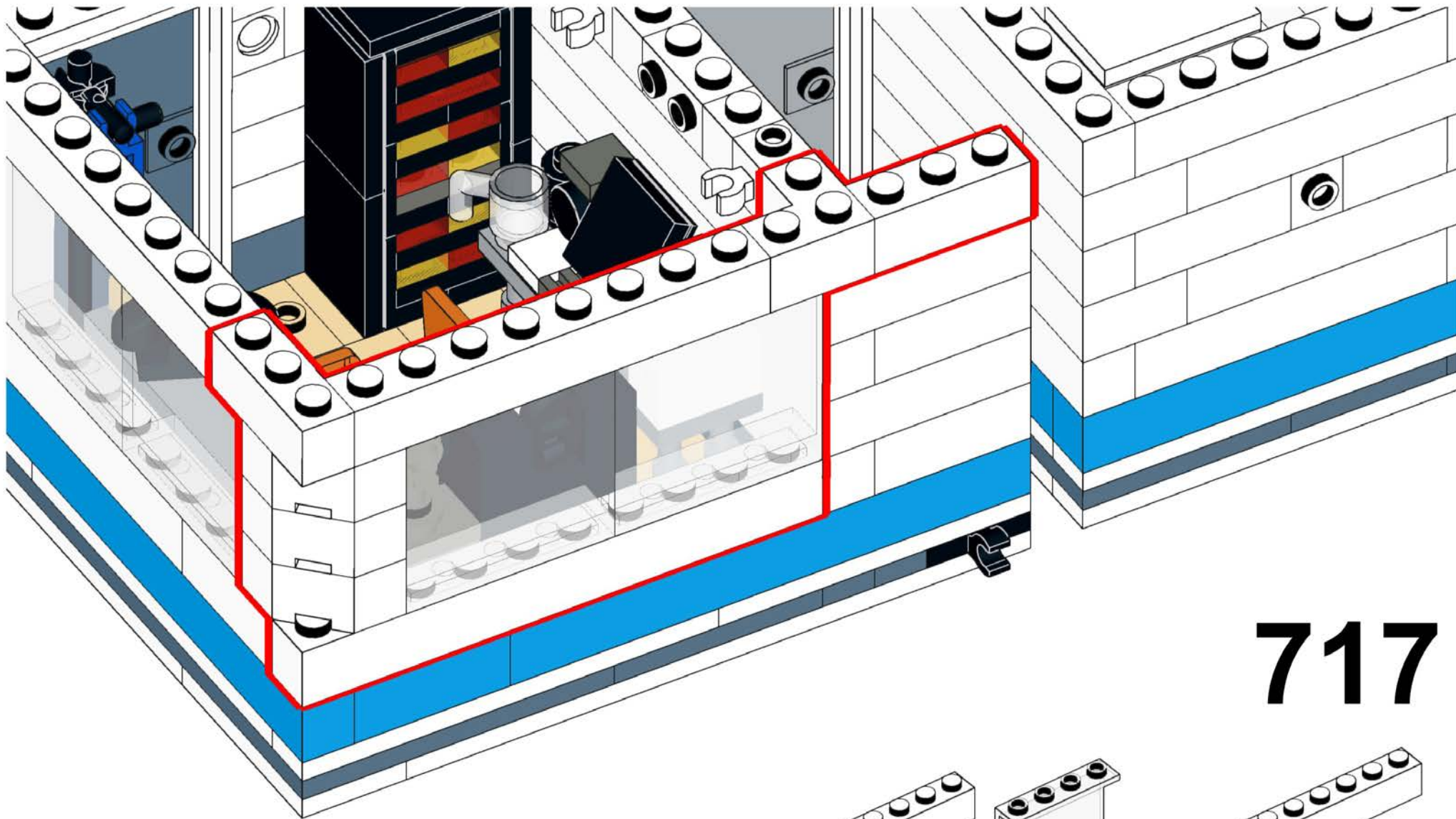

# 717

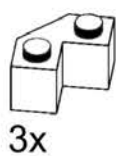

3x

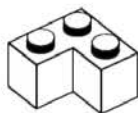

1x

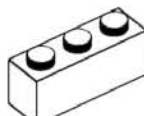

2x

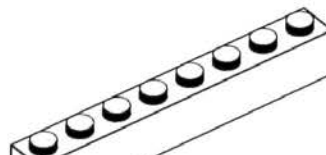

1x

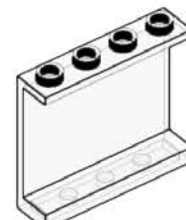



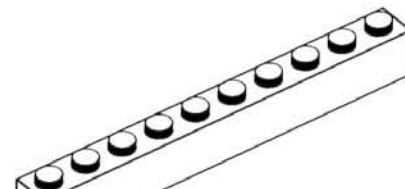

2x

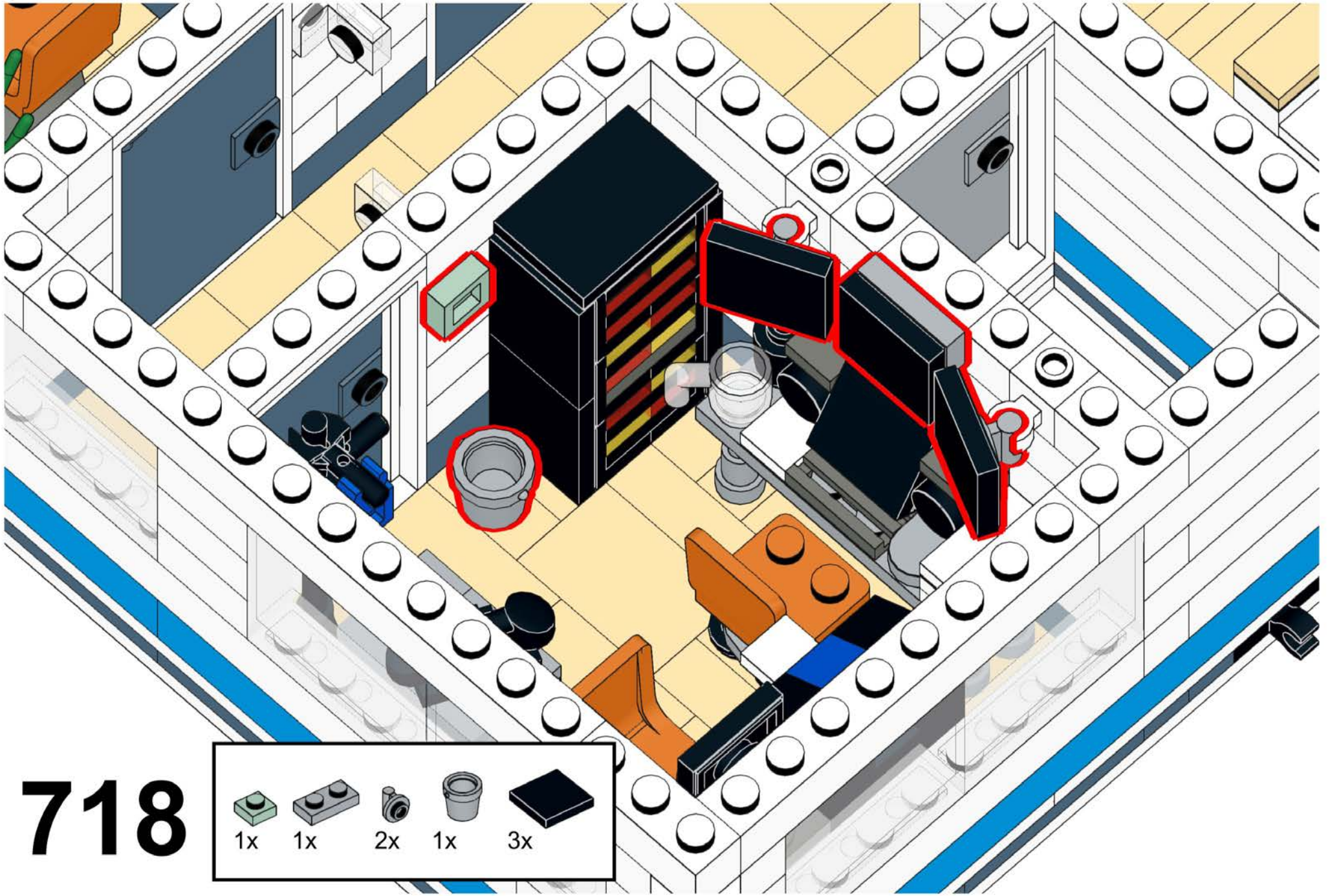

1x



718

- |                                                                                     |                                                                                     |                                                                                     |                                                                                     |                                                                                      |
|-------------------------------------------------------------------------------------|-------------------------------------------------------------------------------------|-------------------------------------------------------------------------------------|-------------------------------------------------------------------------------------|--------------------------------------------------------------------------------------|
|  |  |  |  |  |
| 1x                                                                                  | 1x                                                                                  | 2x                                                                                  | 1x                                                                                  | 3x                                                                                   |

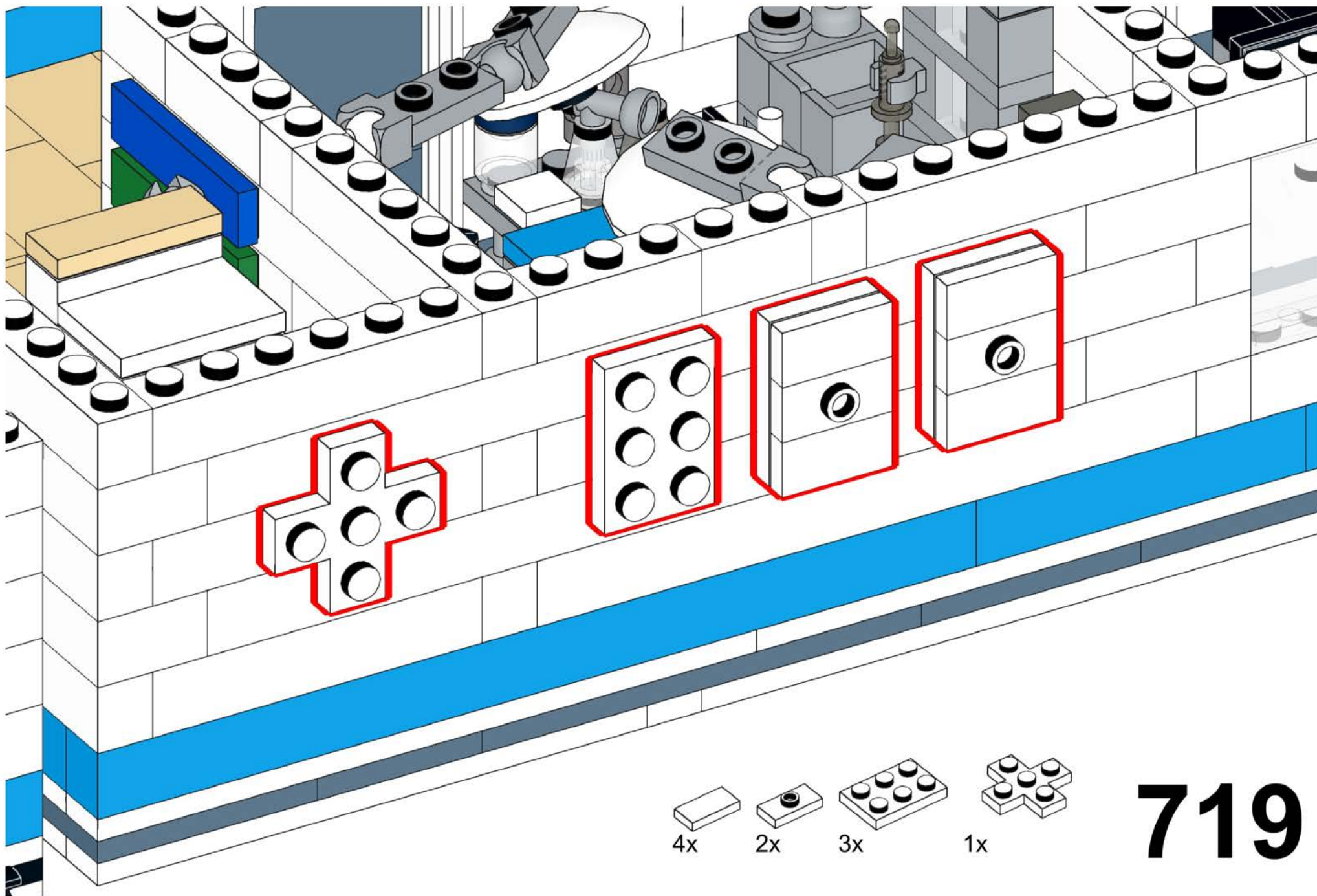

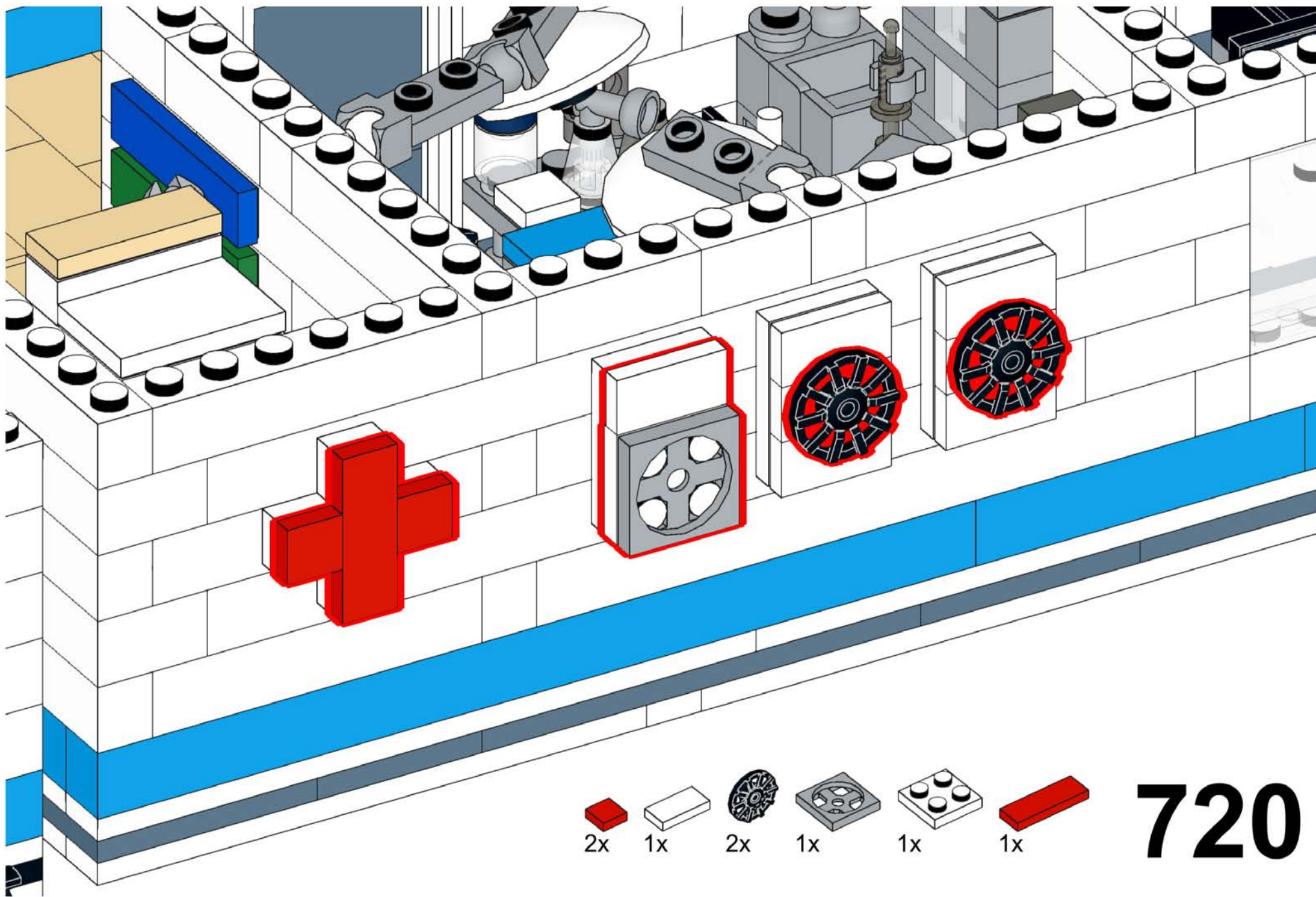

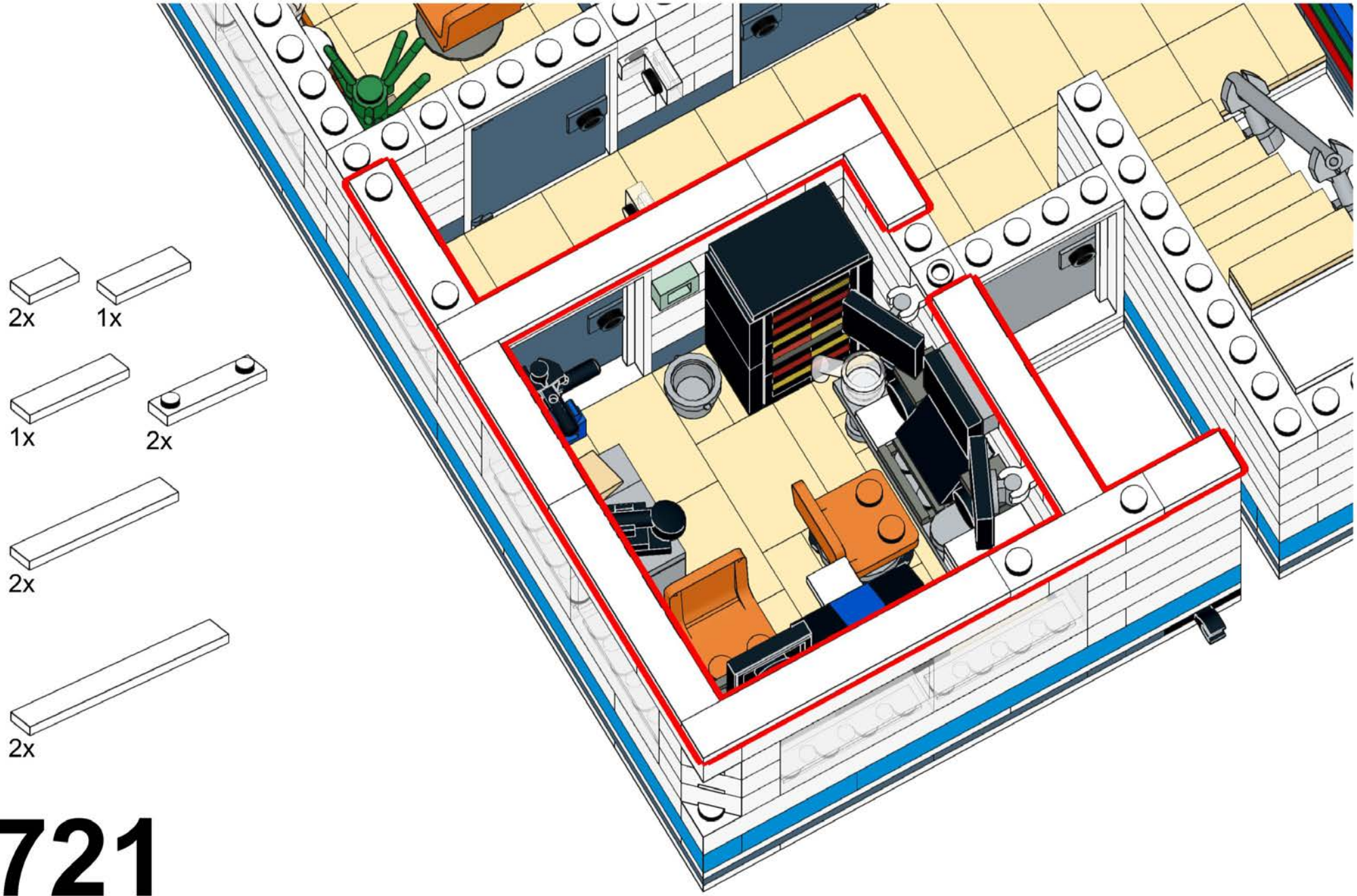

**721**

# 722

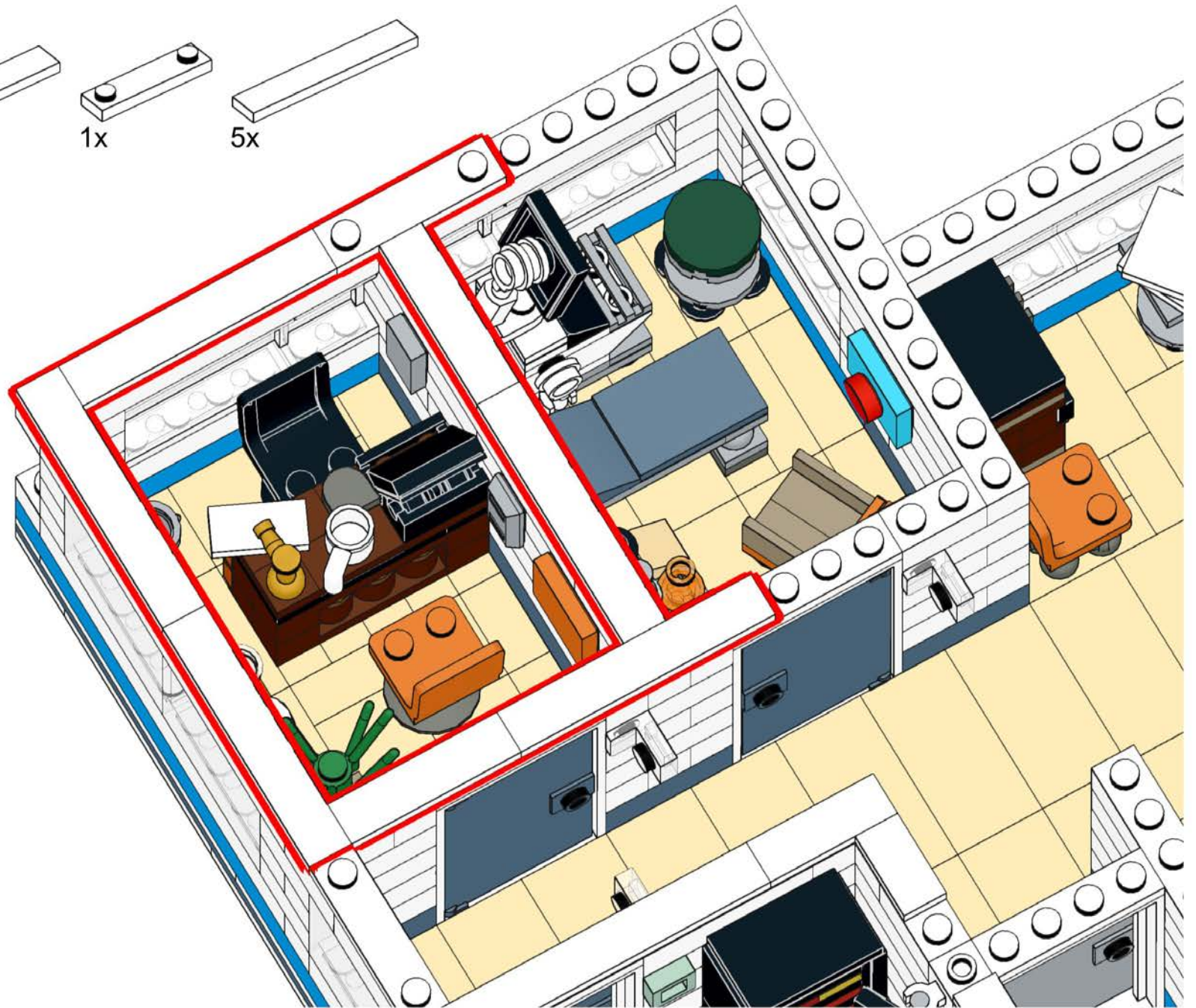
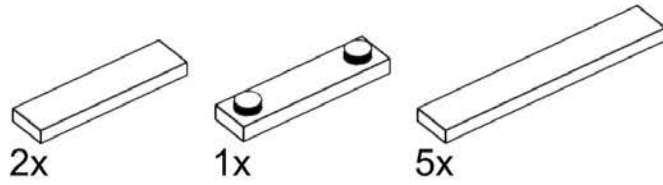

# 723

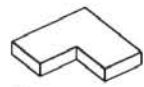

2x

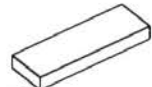

2x

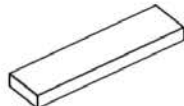

4x

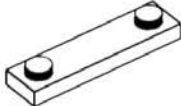

1x

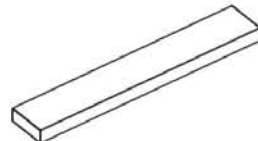

4x

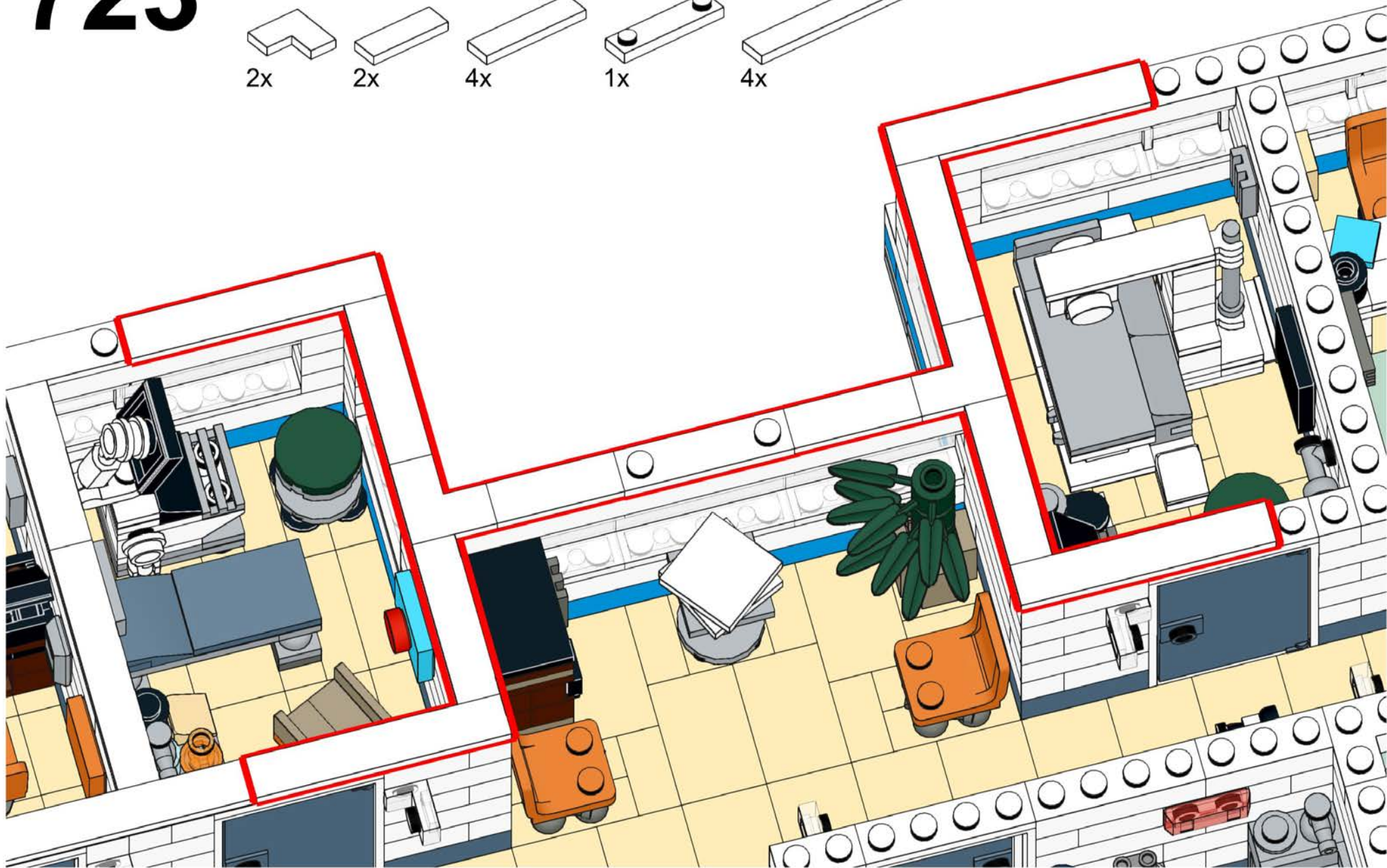

# 724

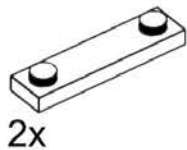

2x

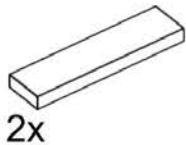

2x

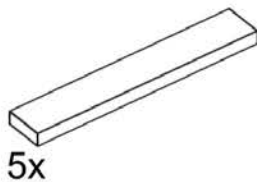

5x

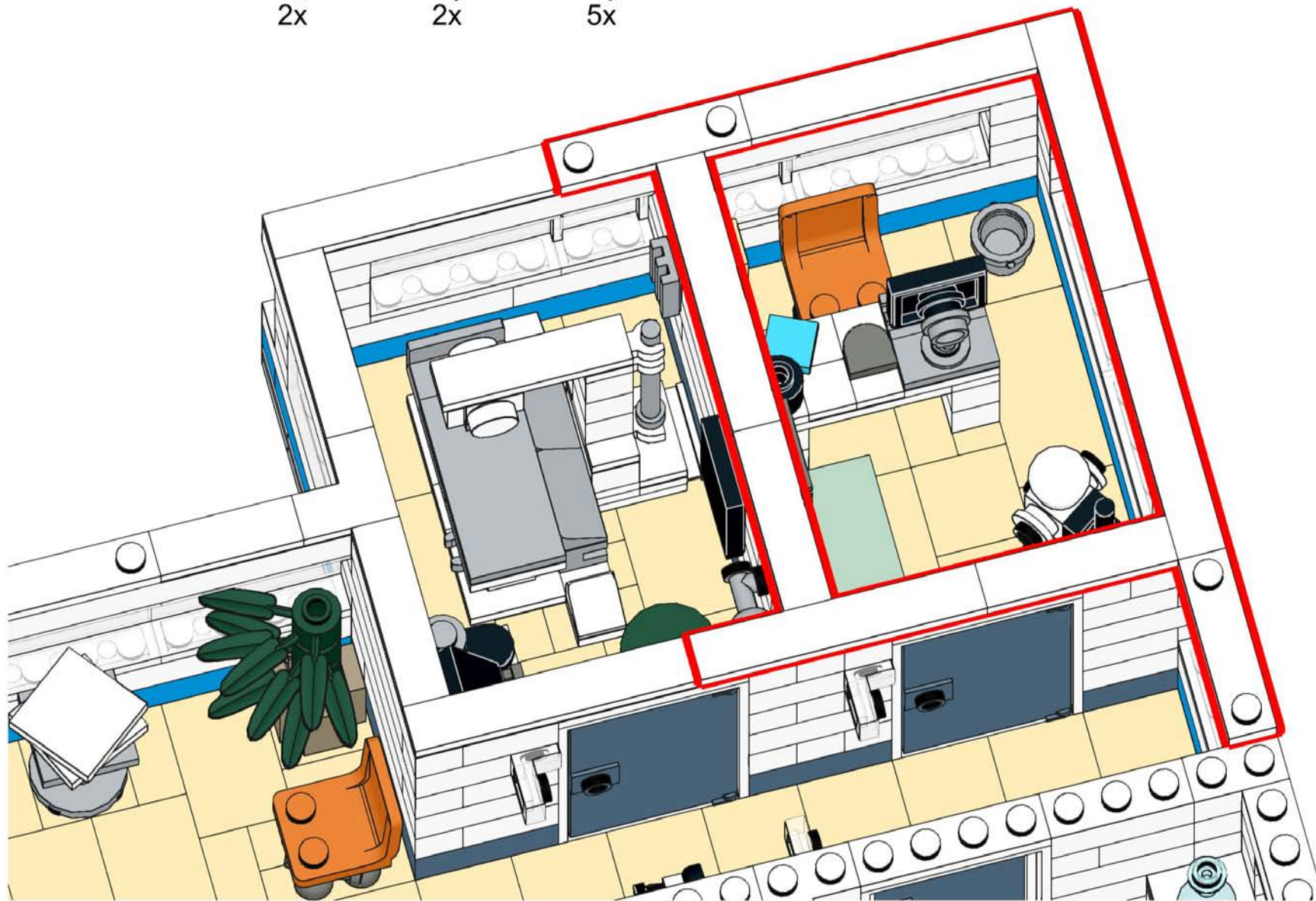



# 725

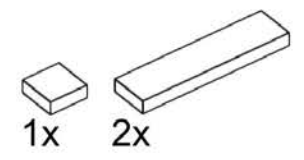
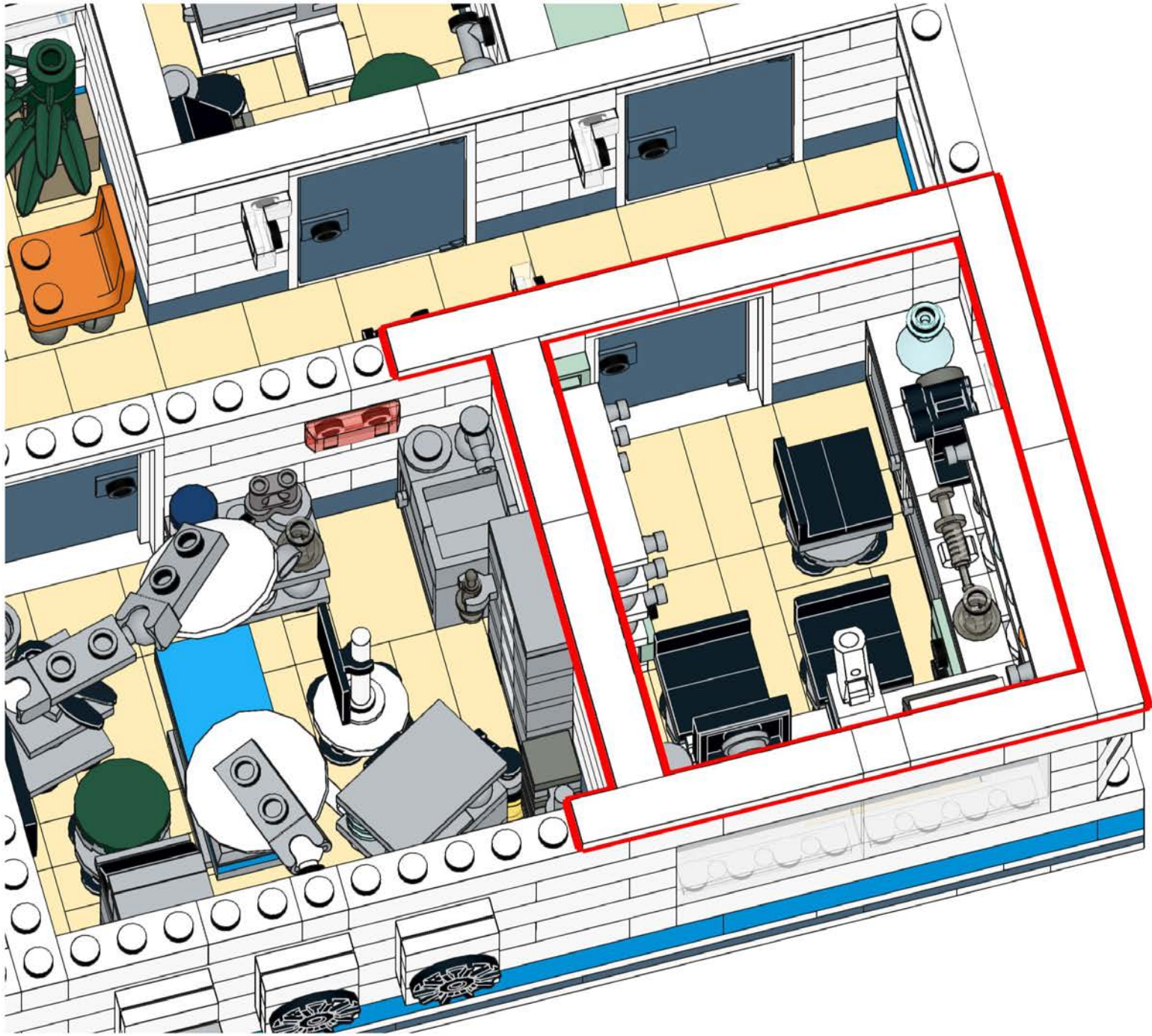

1x 2x

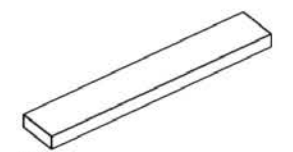

6x

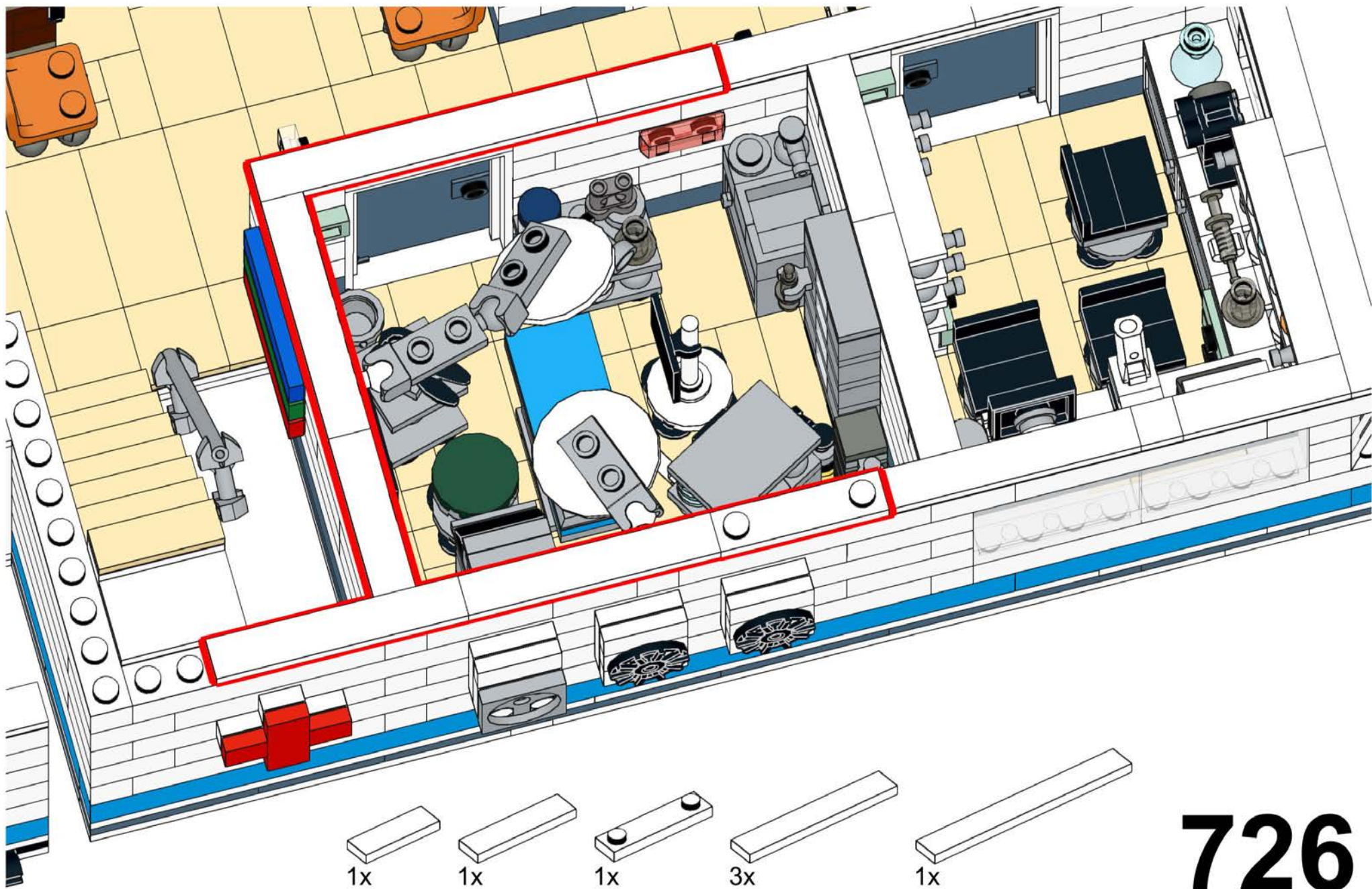

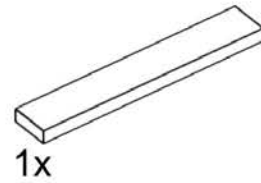
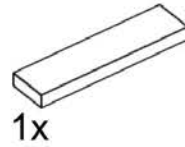
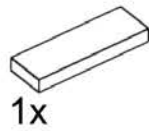
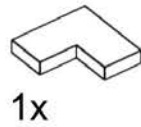
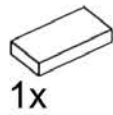
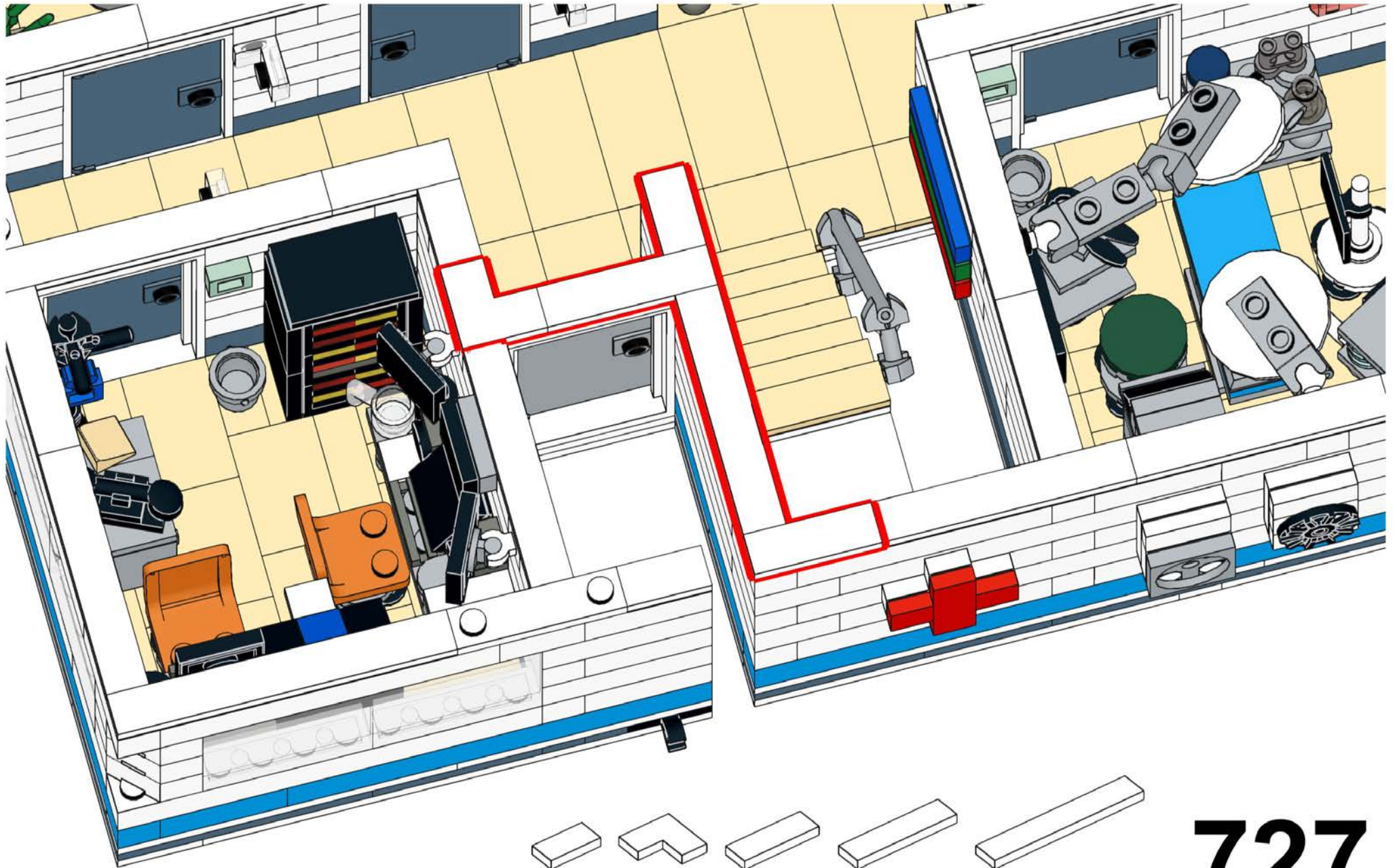

**726**



**727**

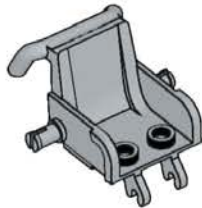

1x  2x 

1x 

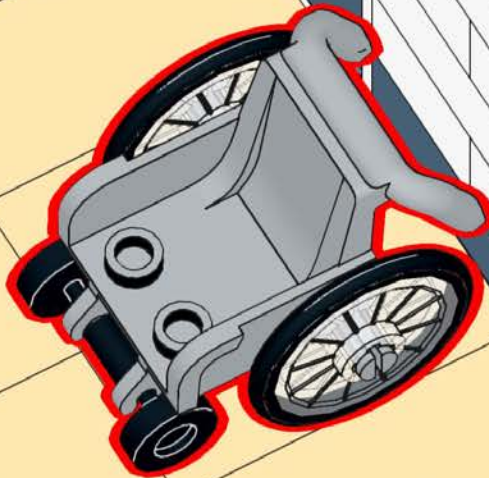

728

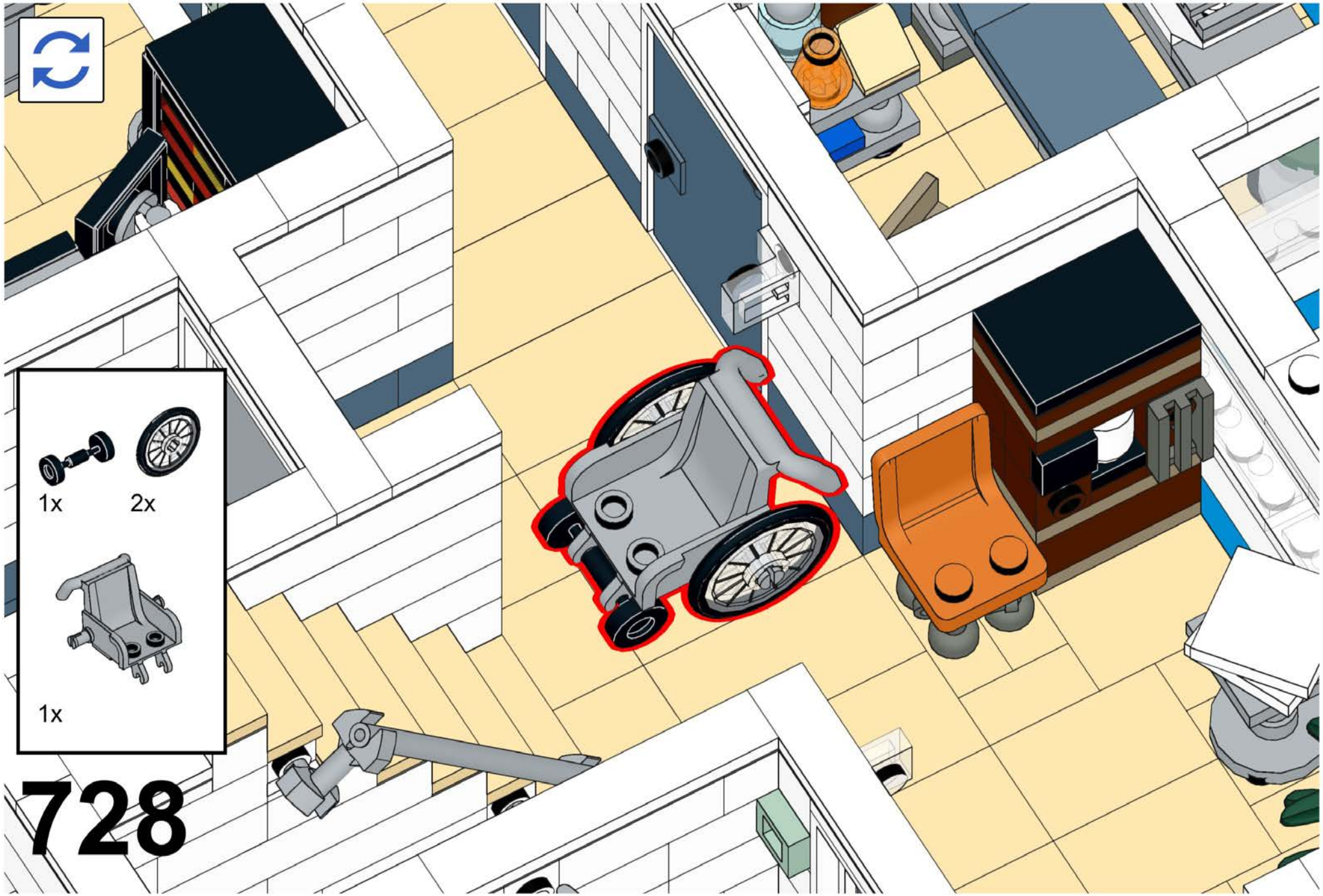

# 729

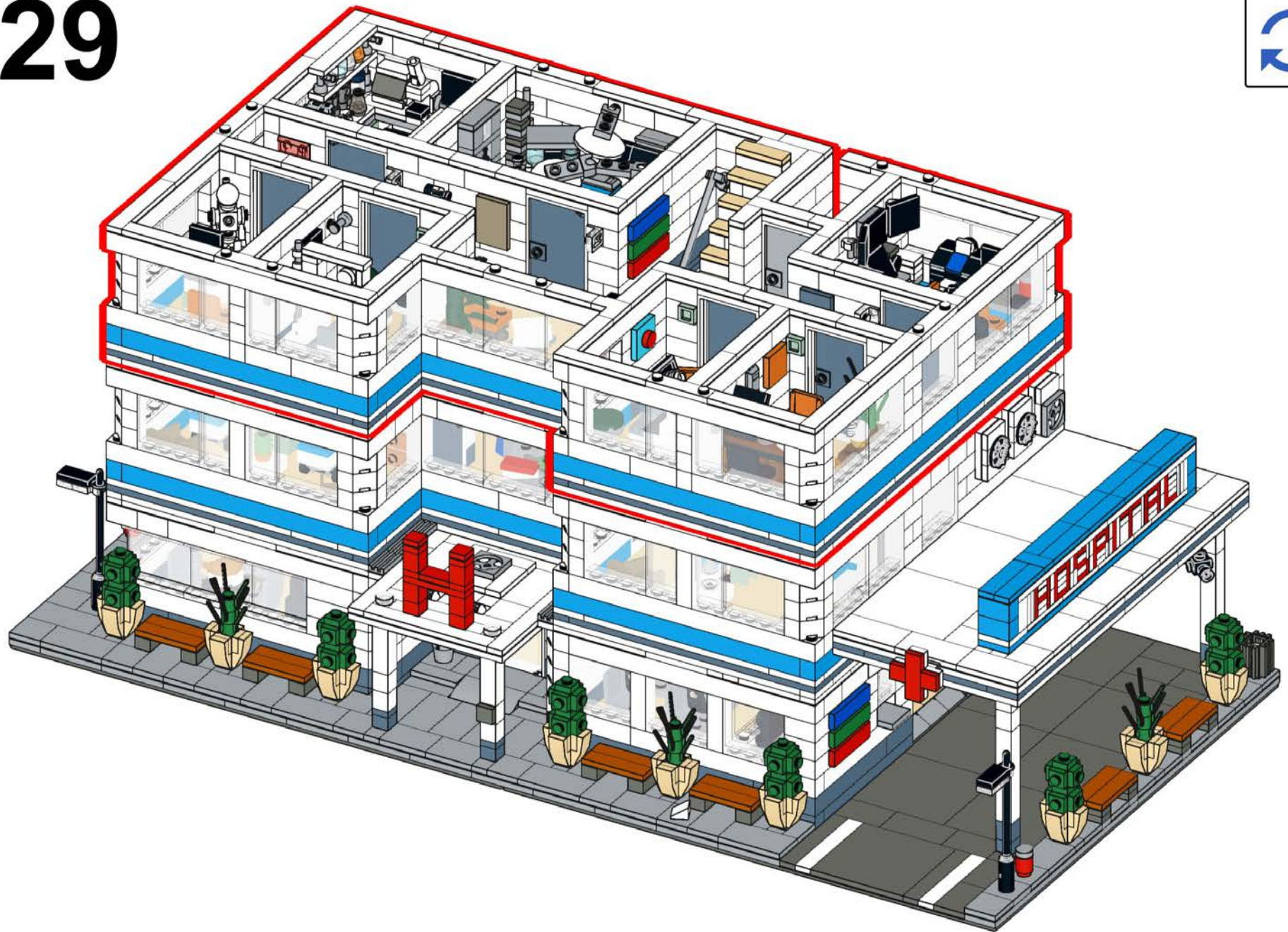

# 730

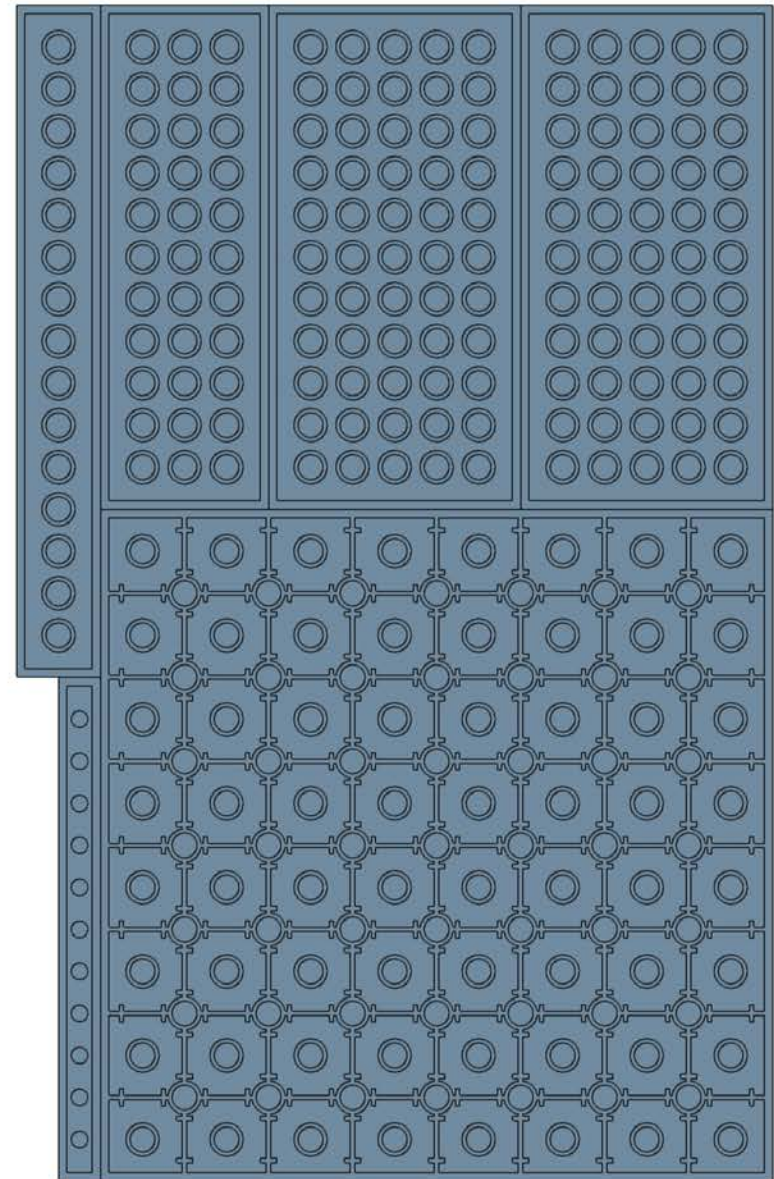
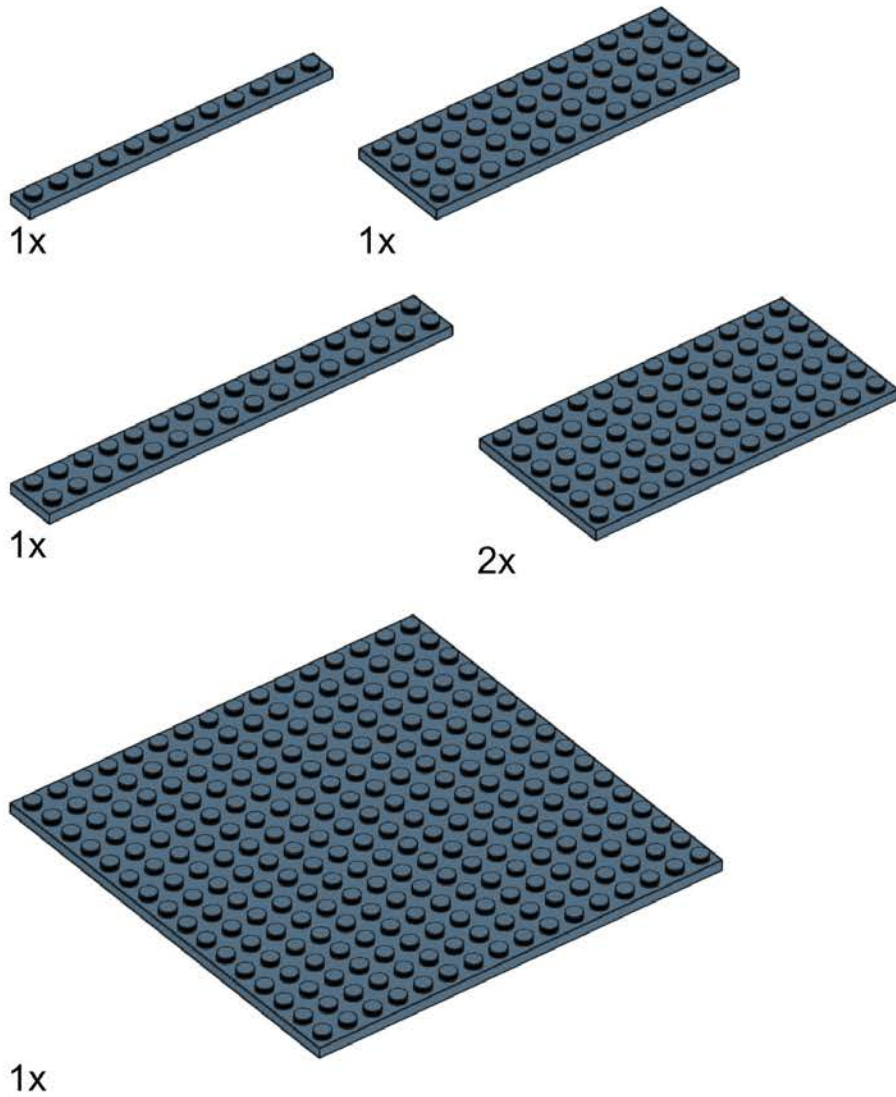
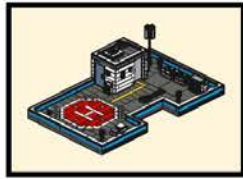

# 731

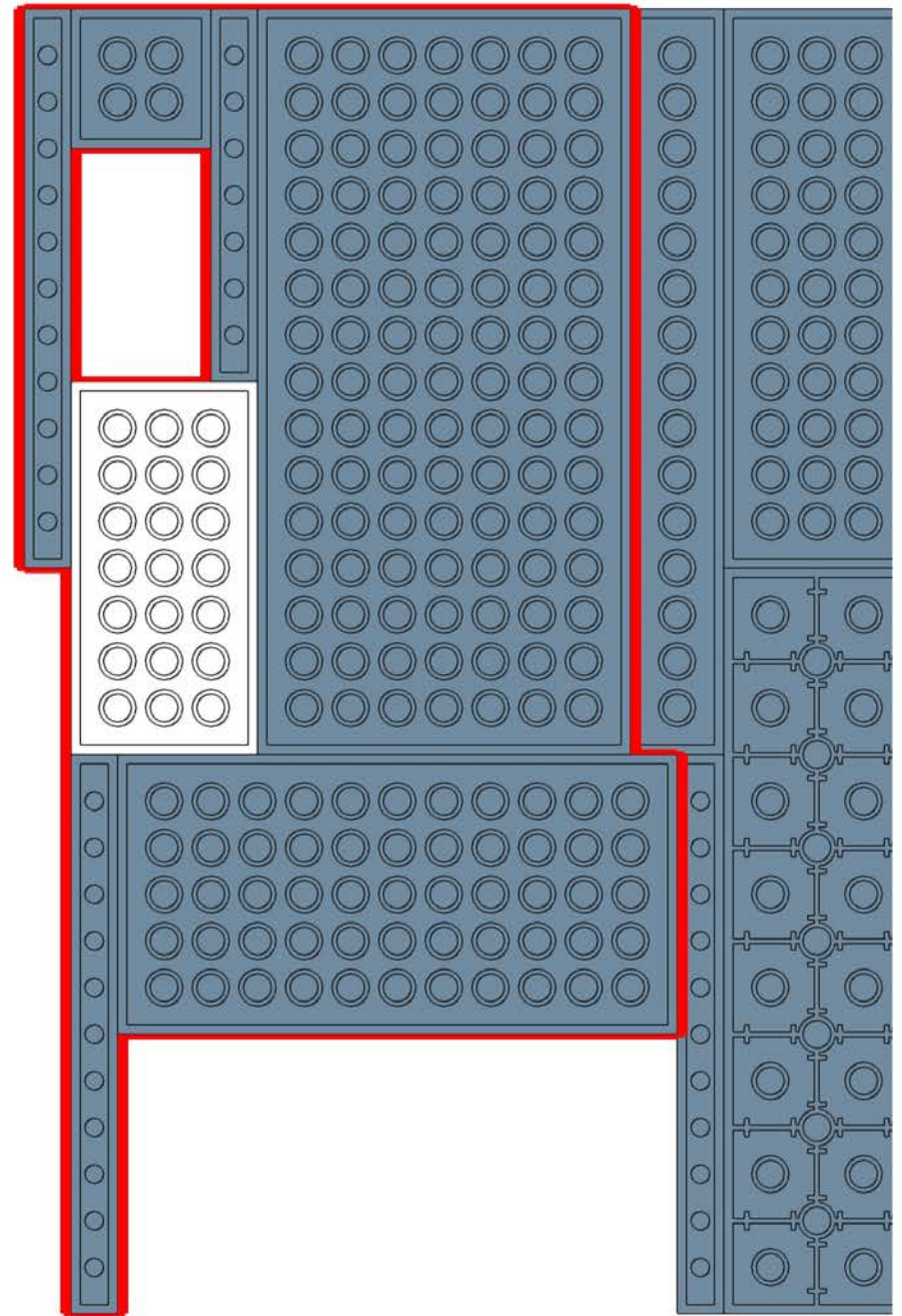
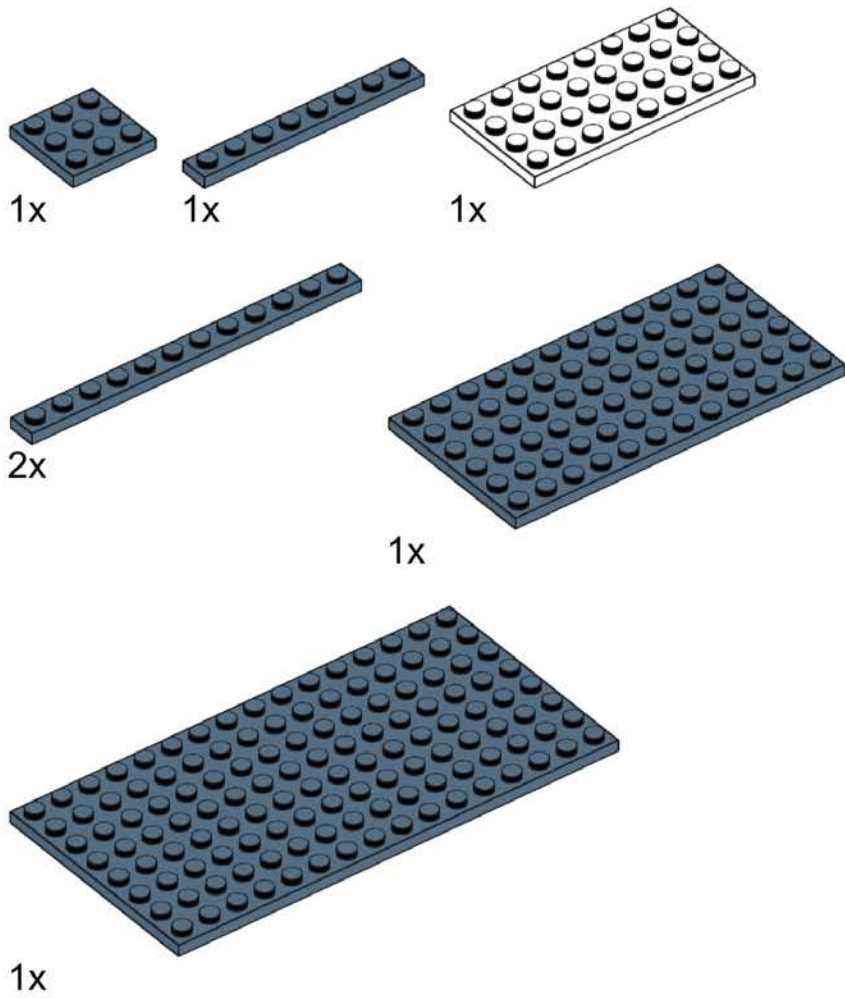





# 733

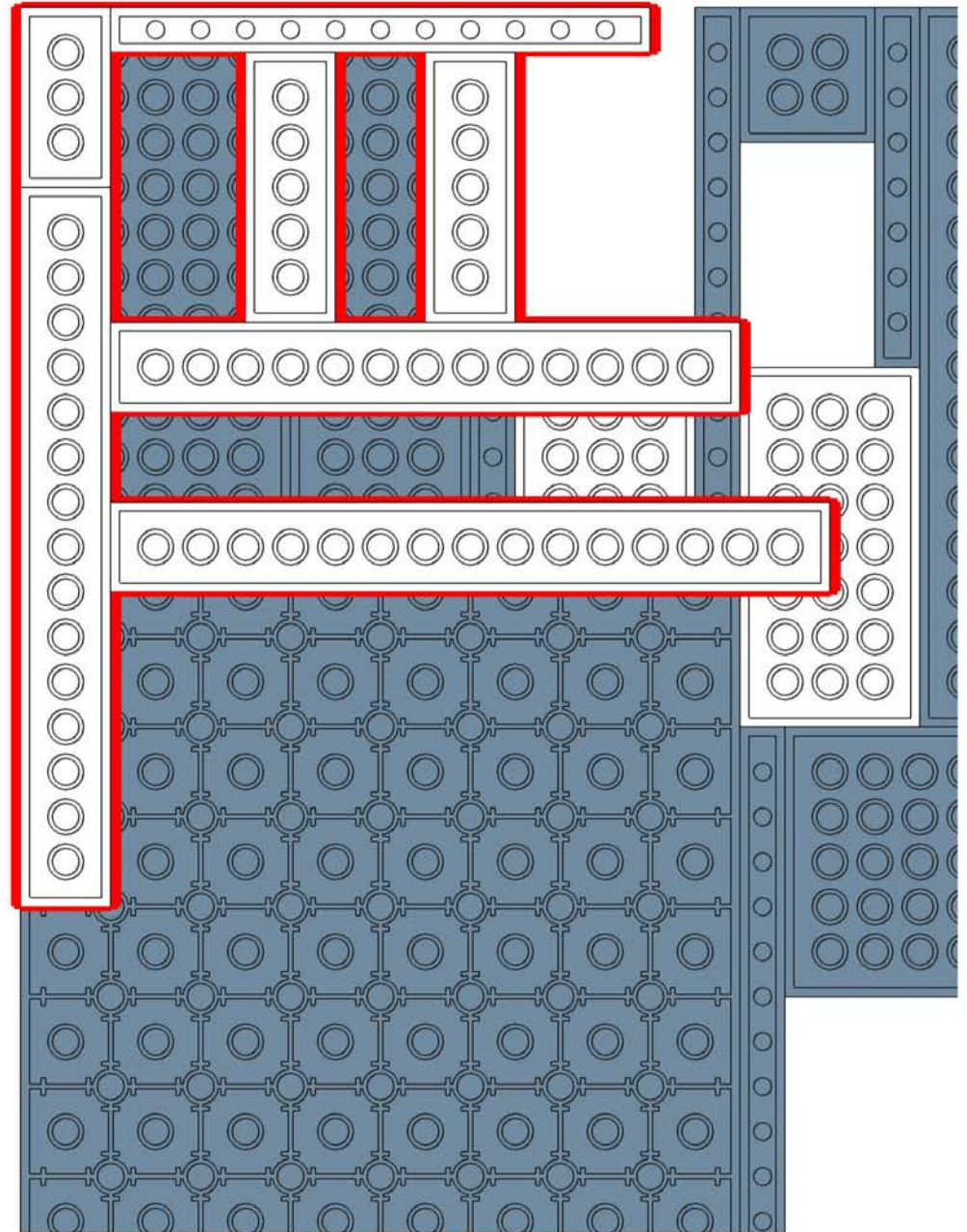
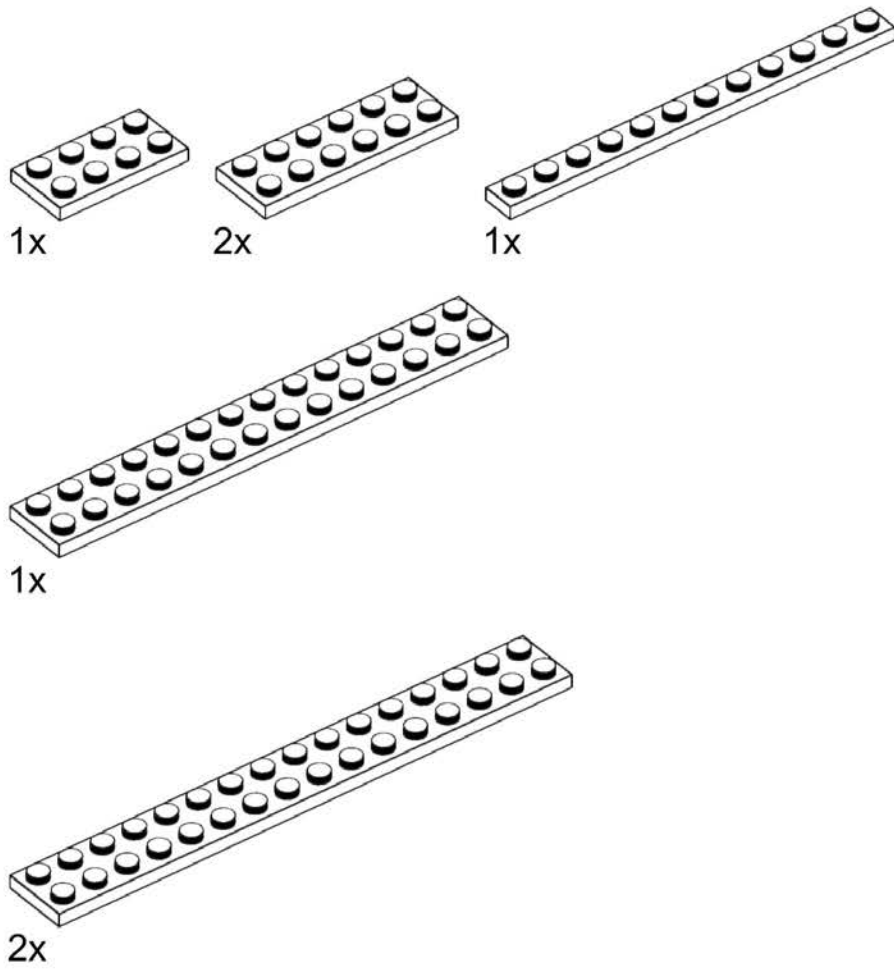

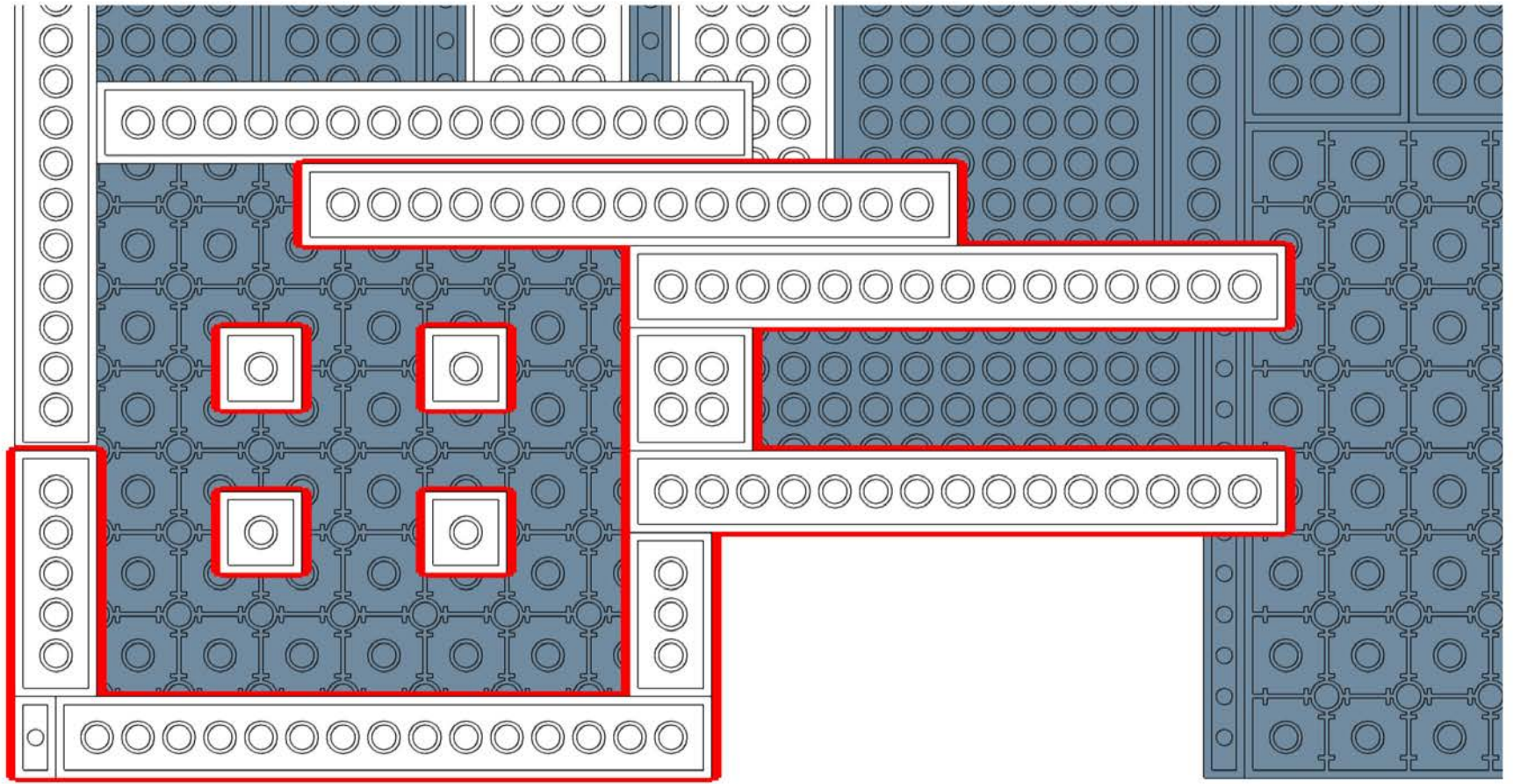

734

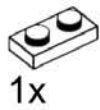

1x

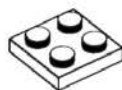

4x

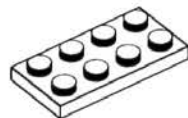

1x

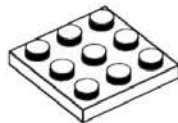

1x

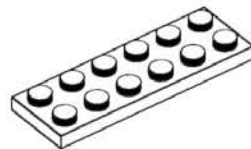

1x

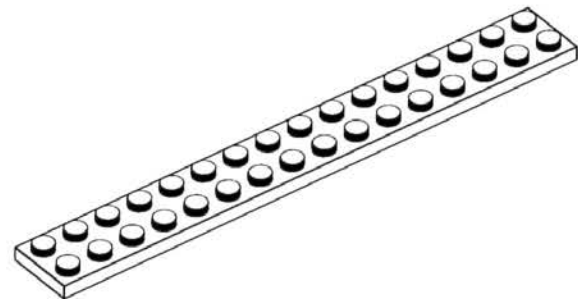

4x

# 735

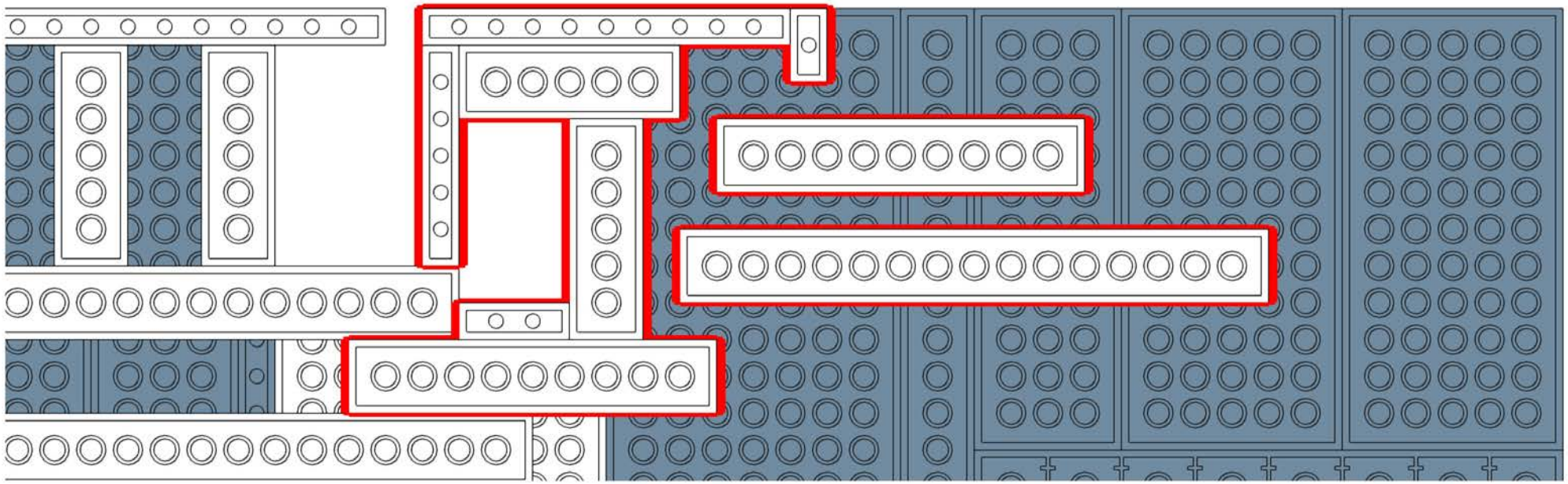
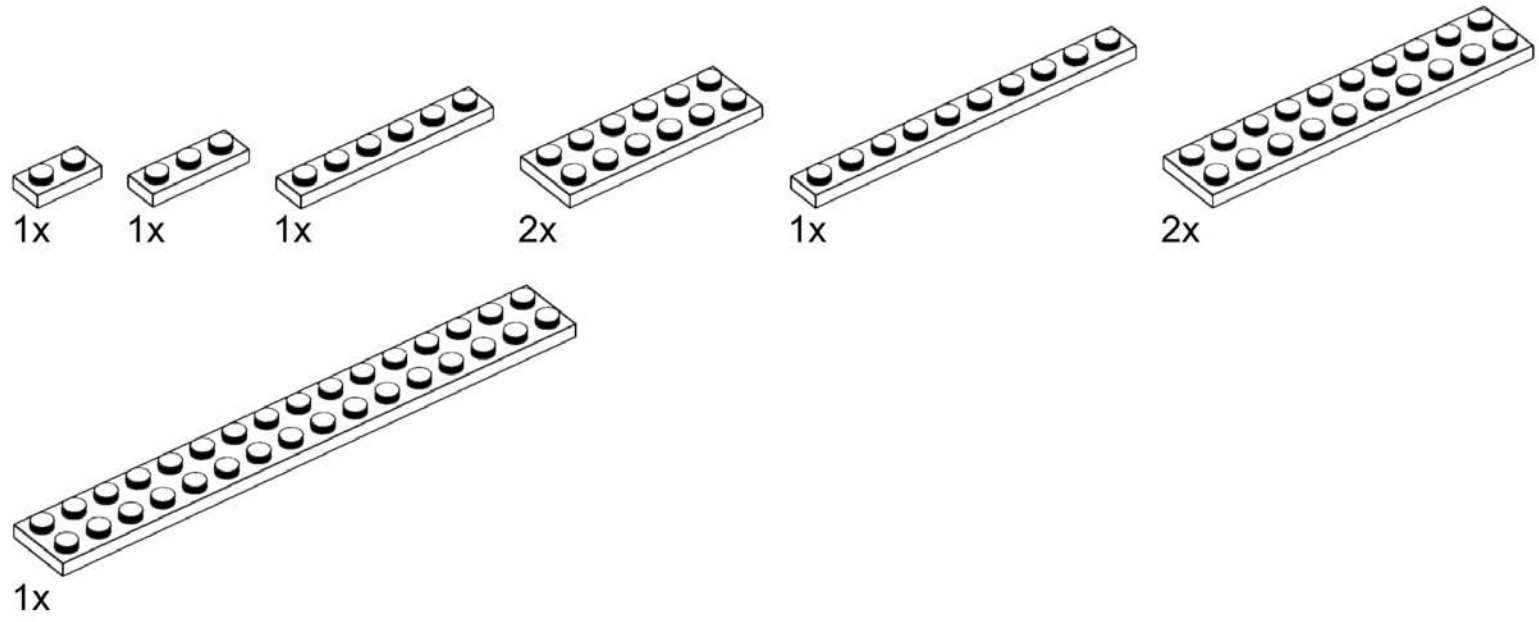

# 736

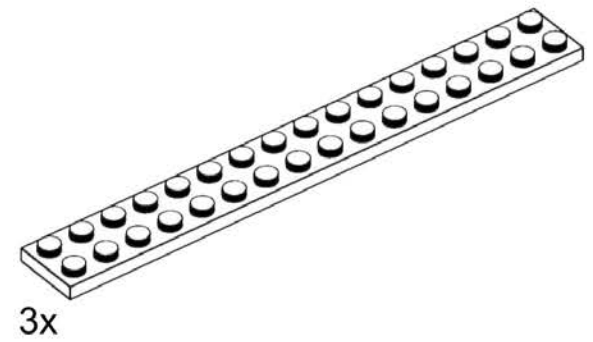
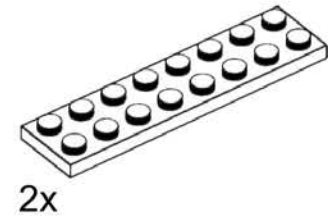
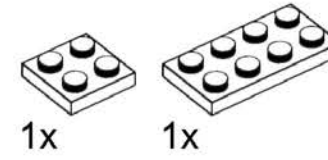
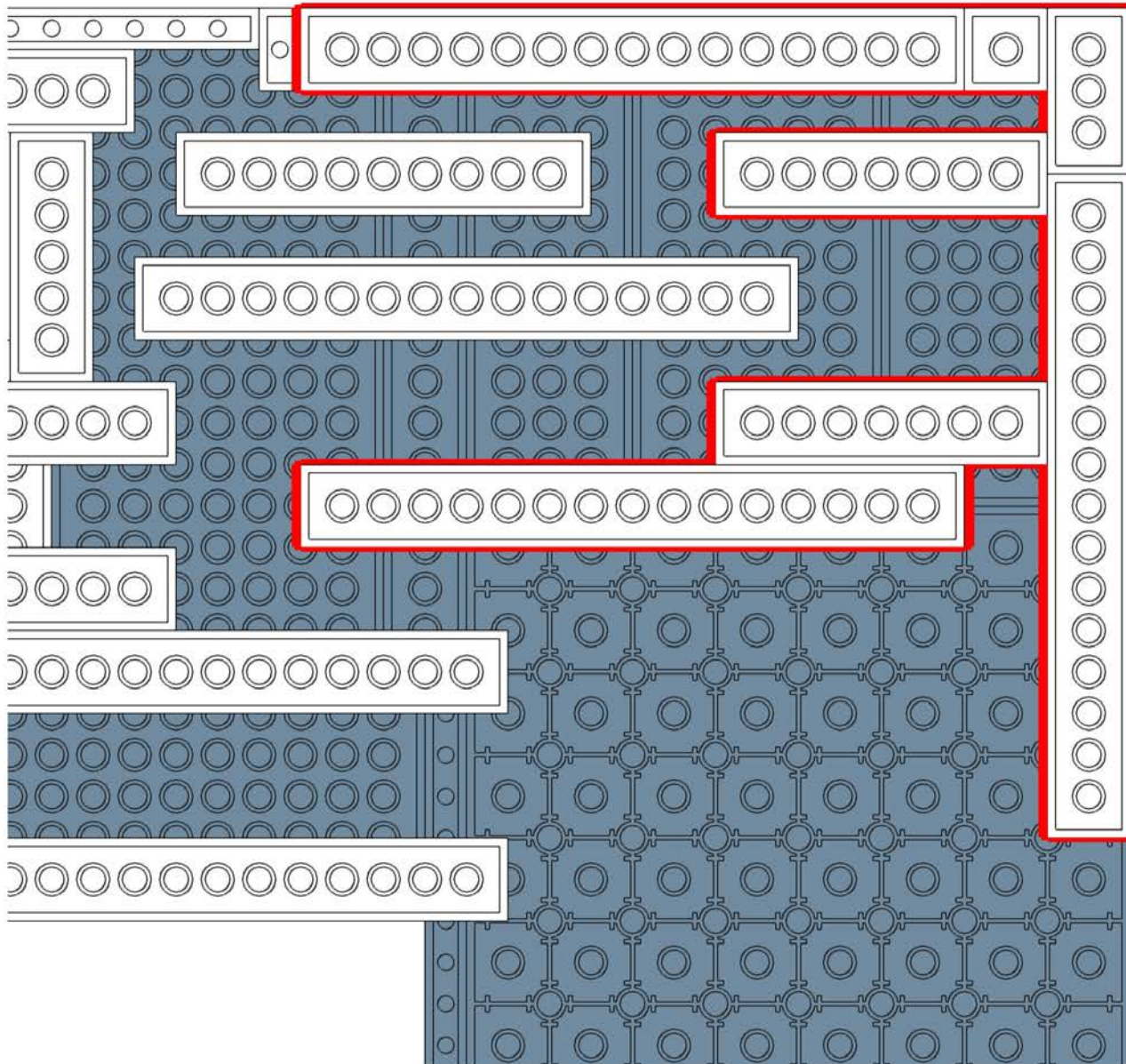

# 737

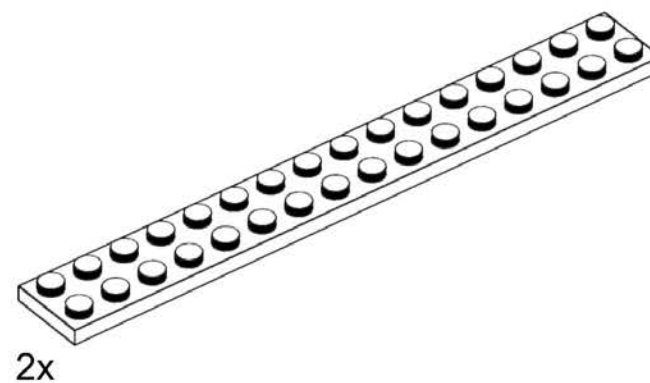
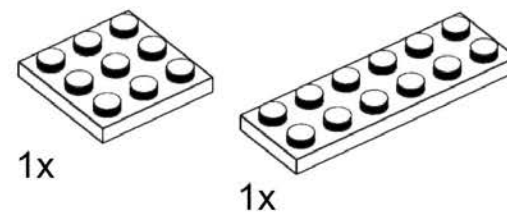
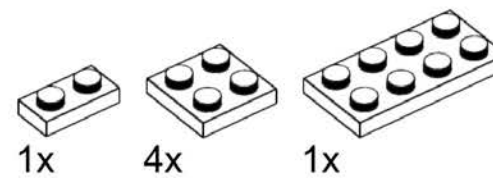
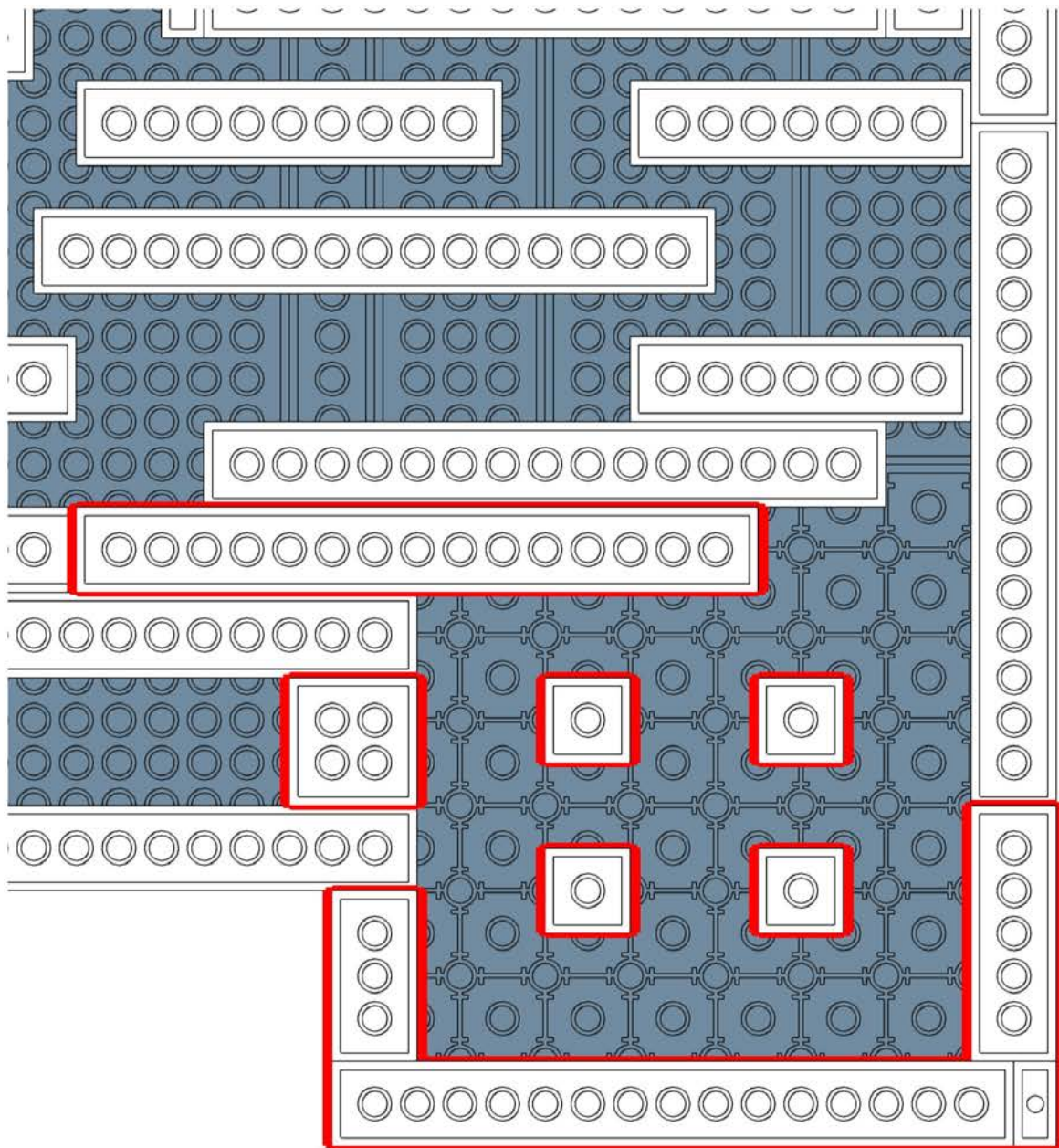

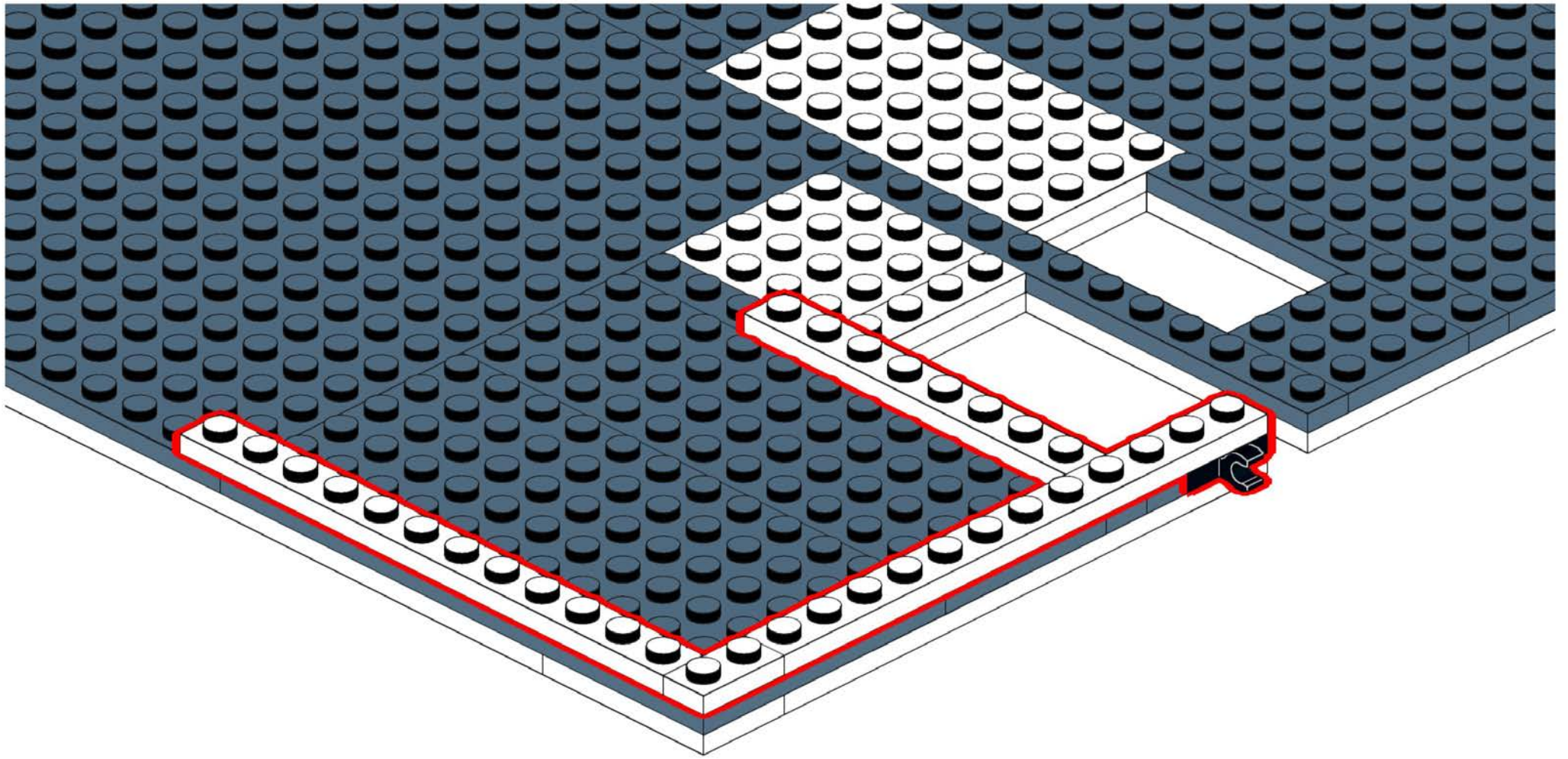

738

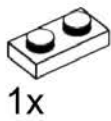

1x



1x

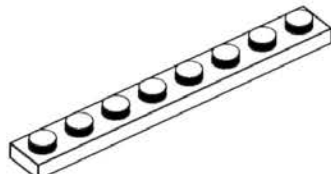

1x

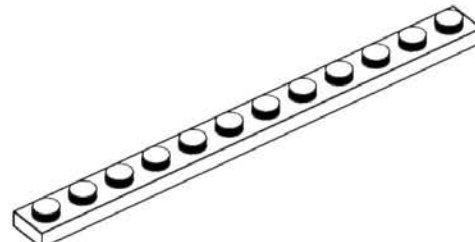

2x



# 739

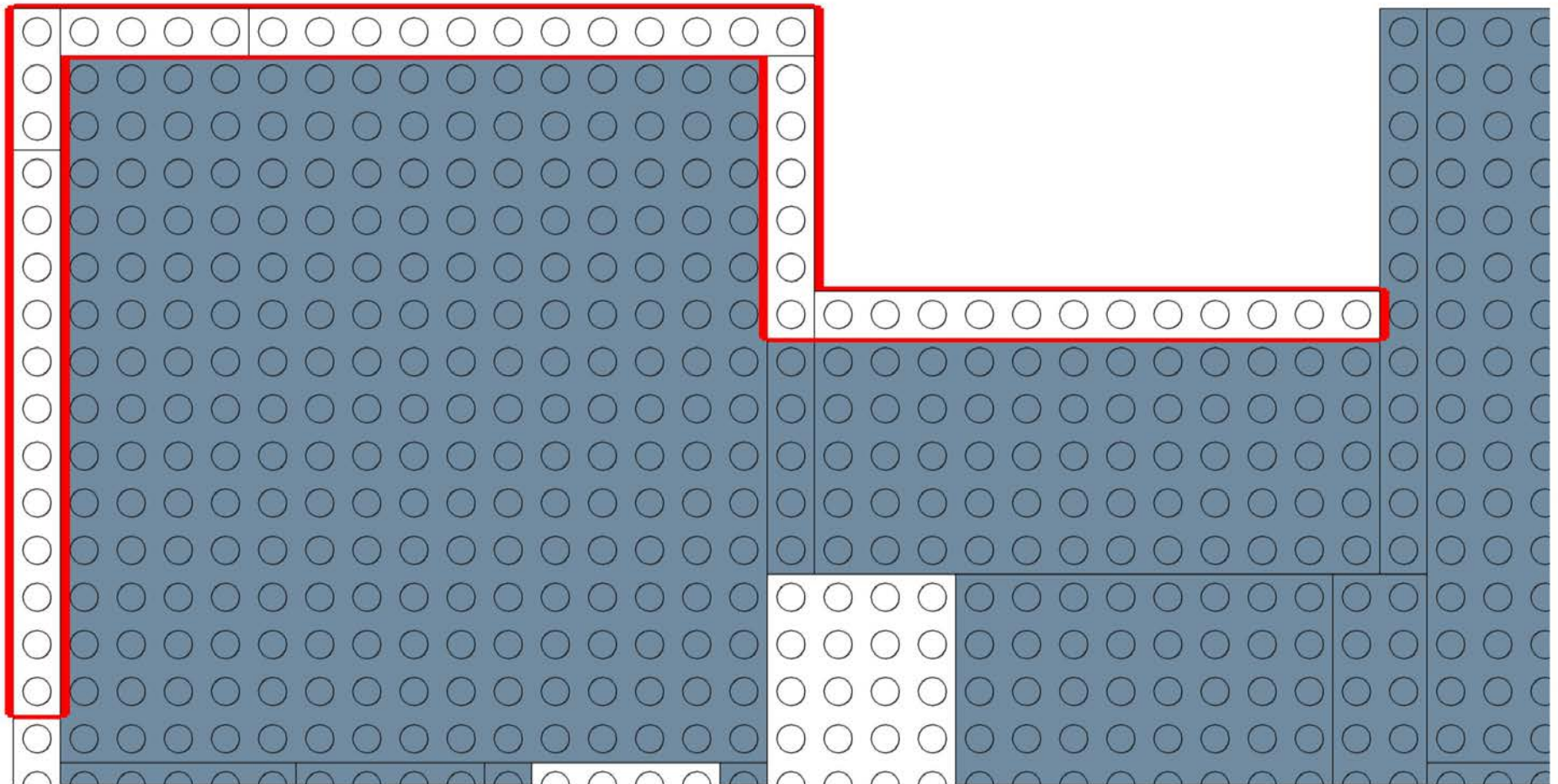
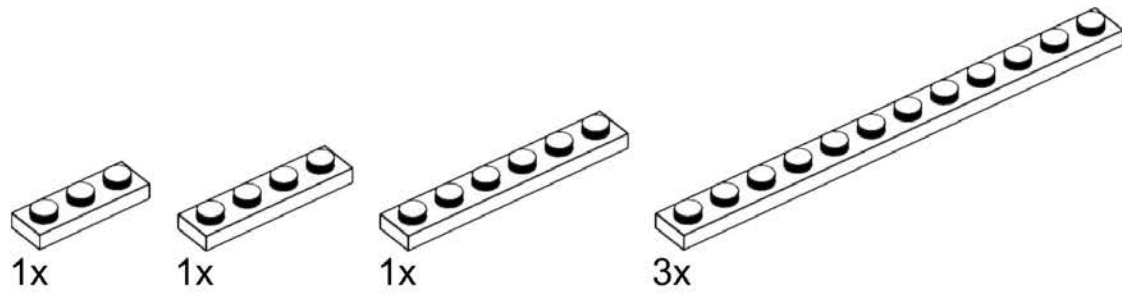

# 740

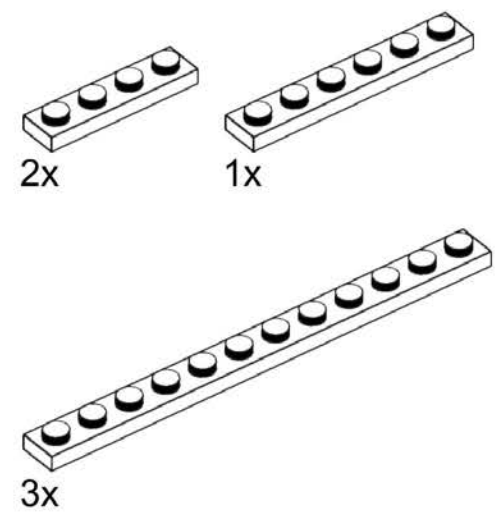
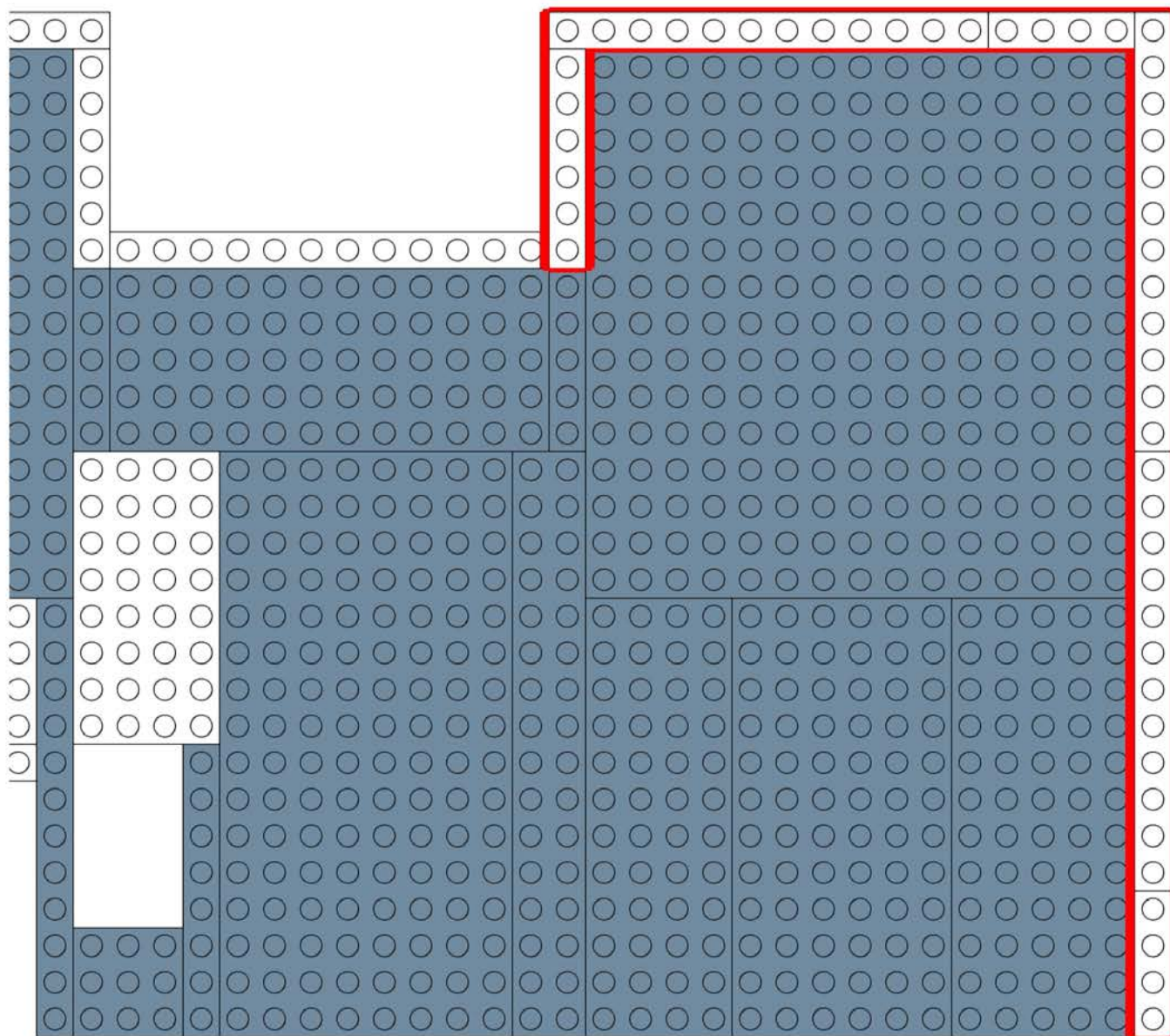



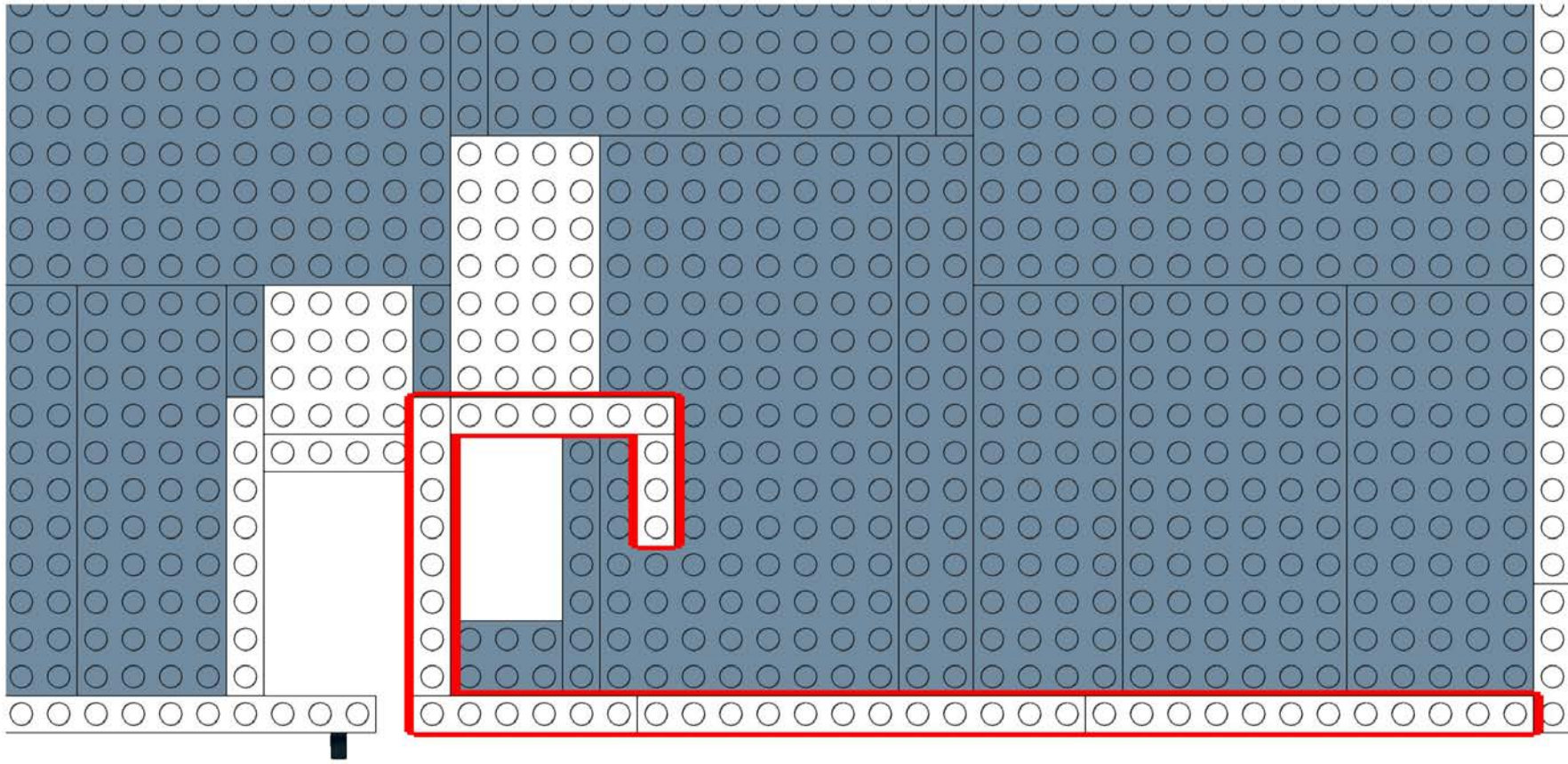

741

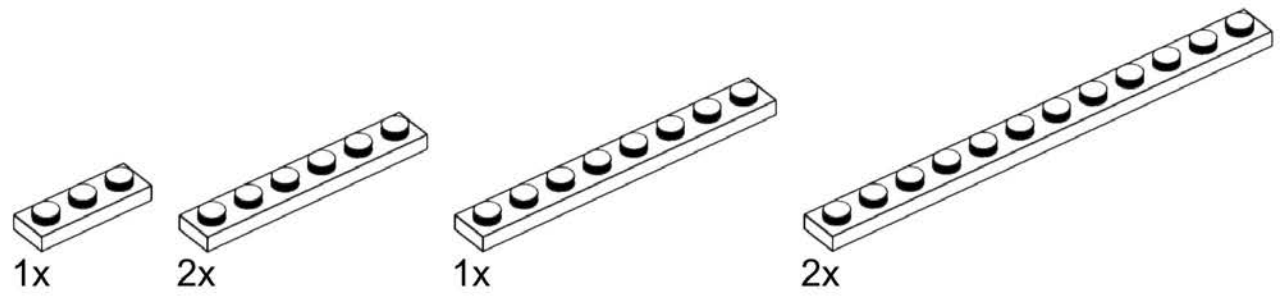

# 742

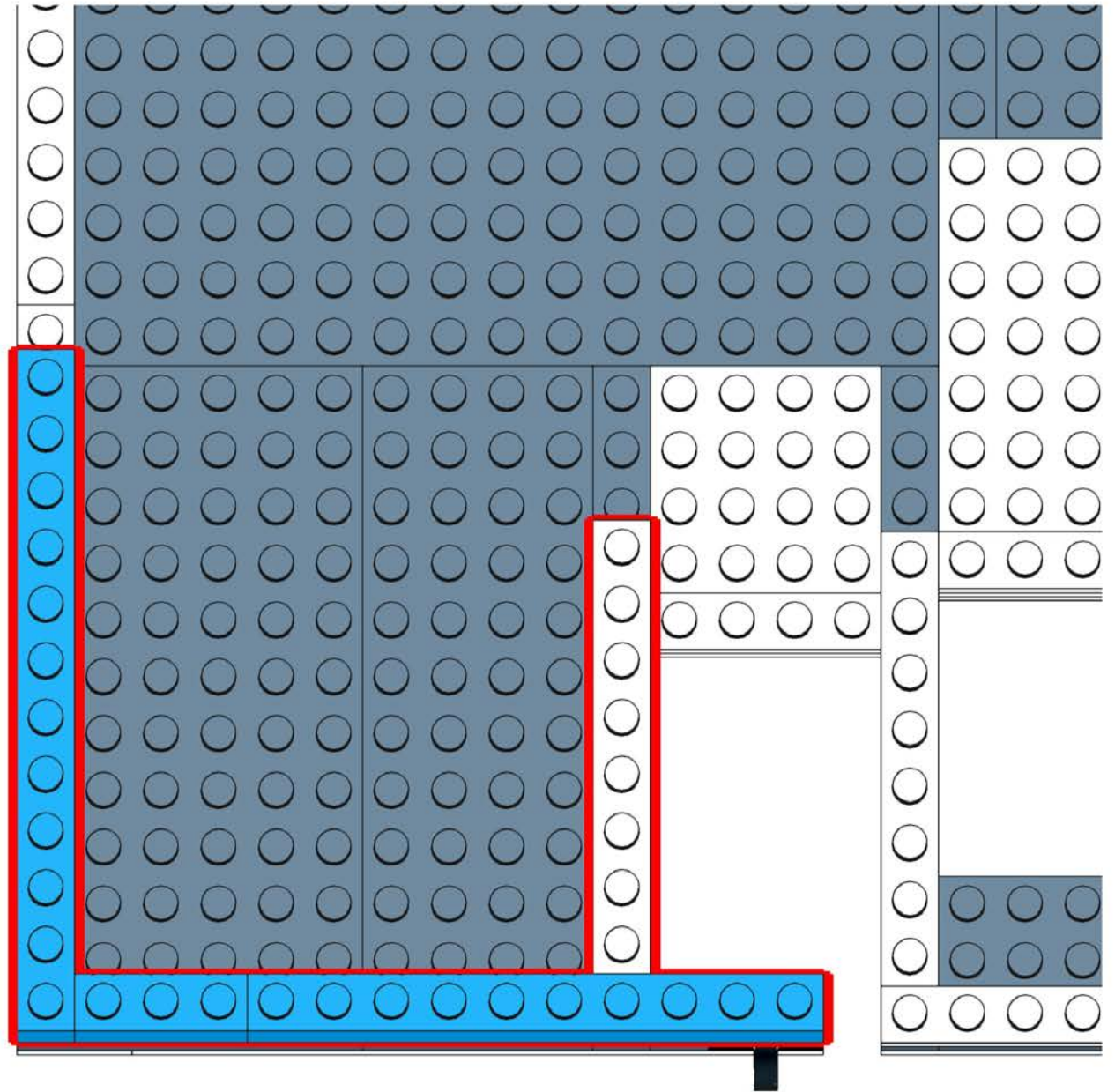
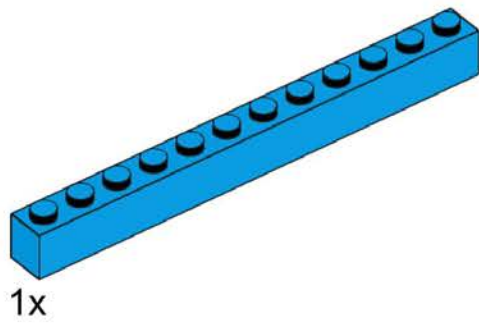
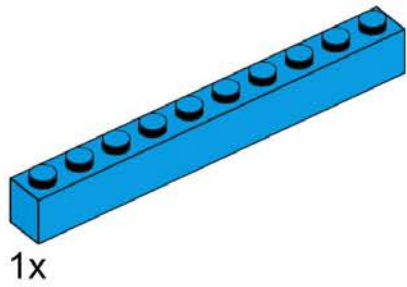
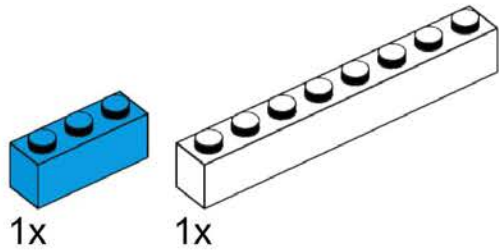

# 743

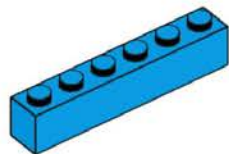

1x

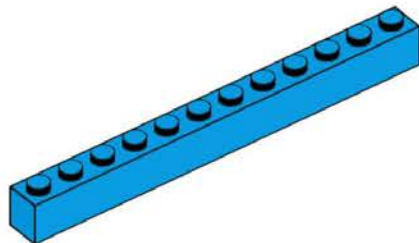

1x

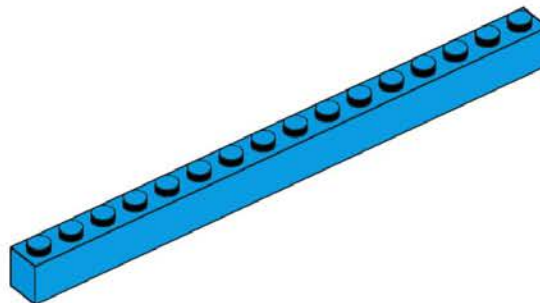

2x

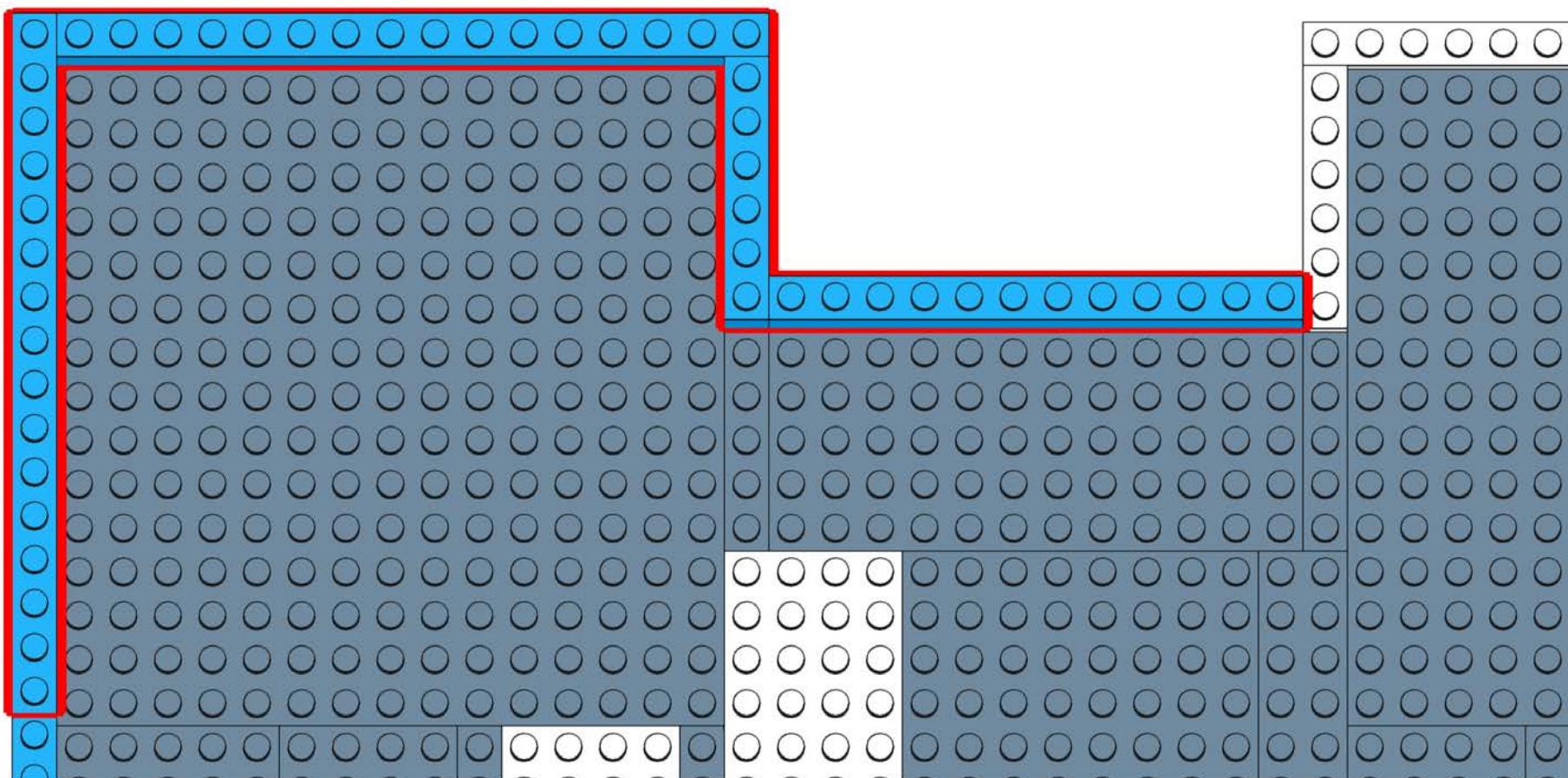

# 744

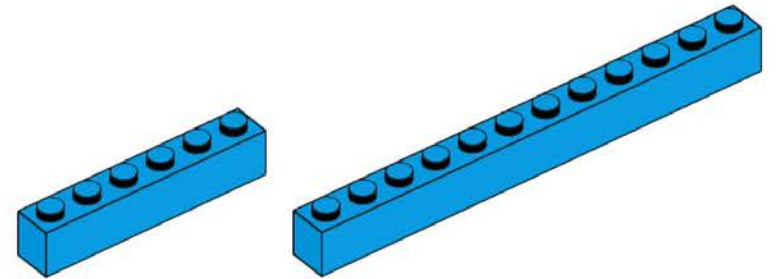
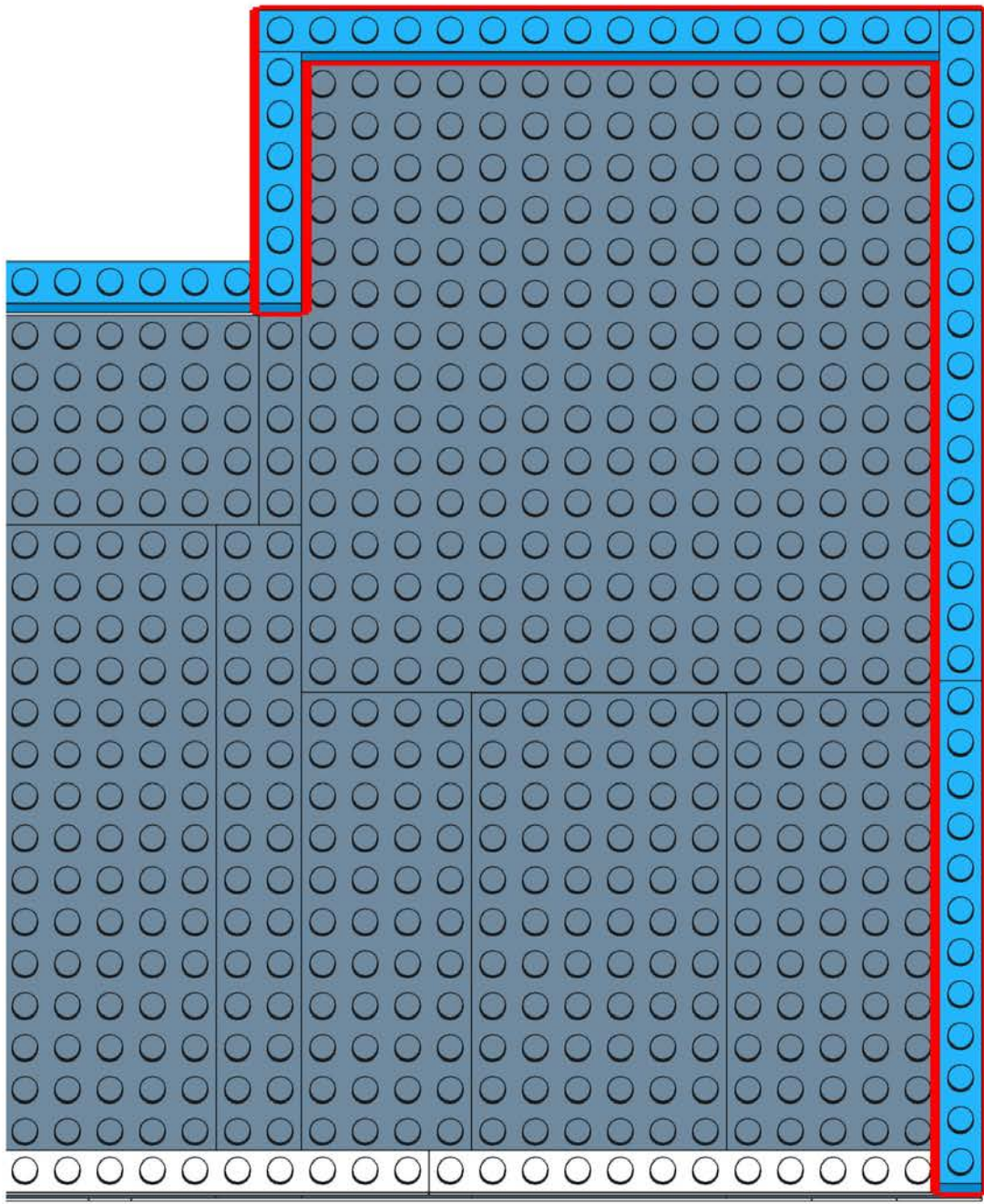

1x

1x

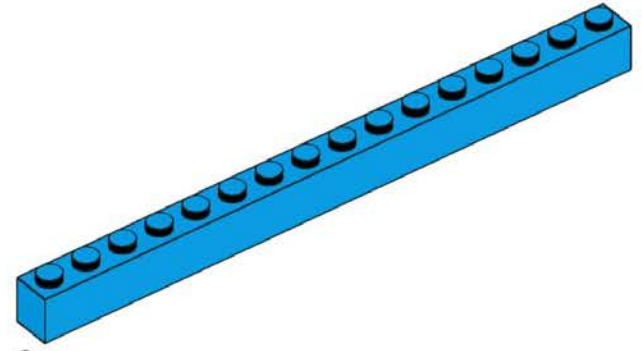

2x

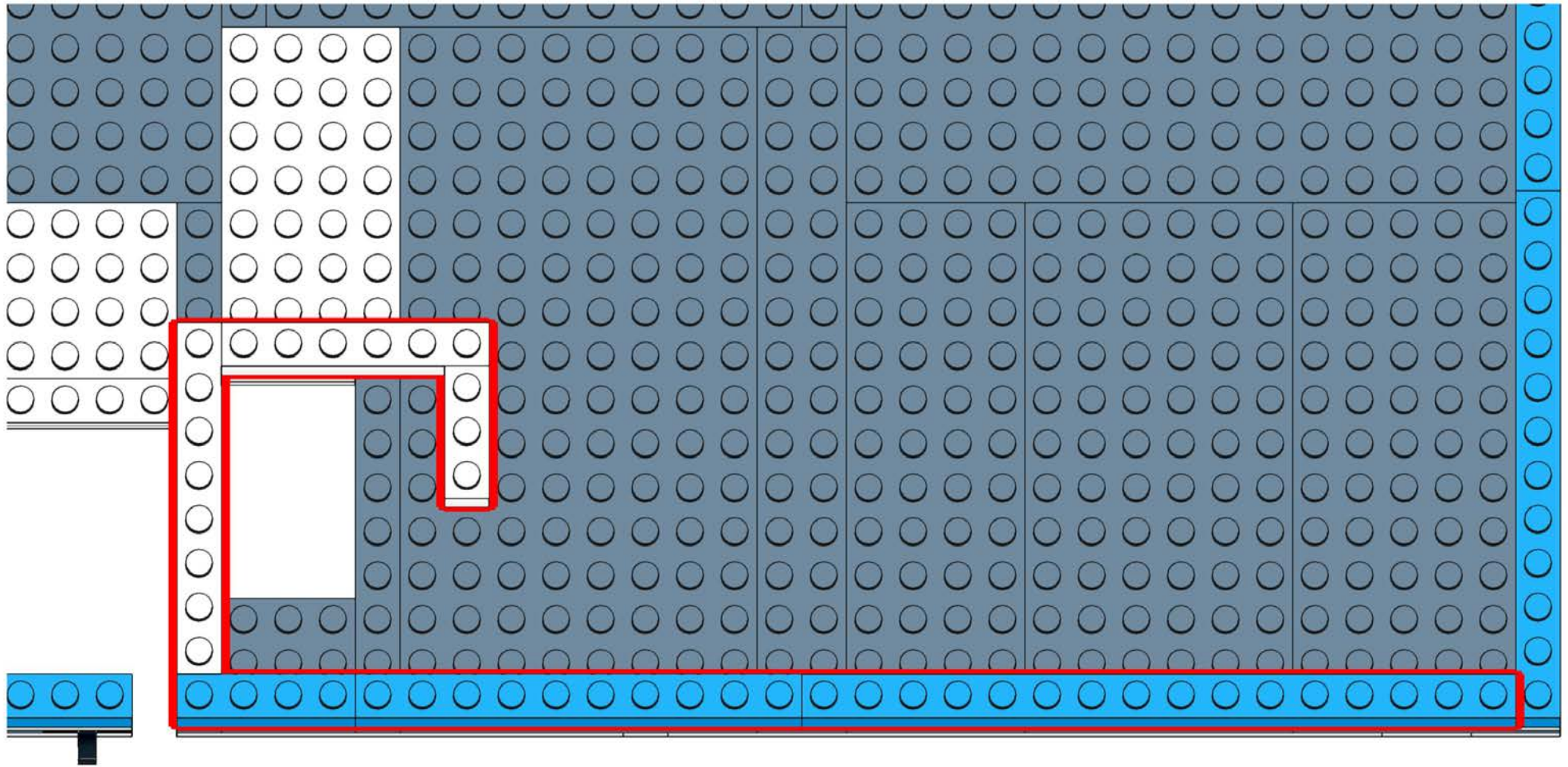

745

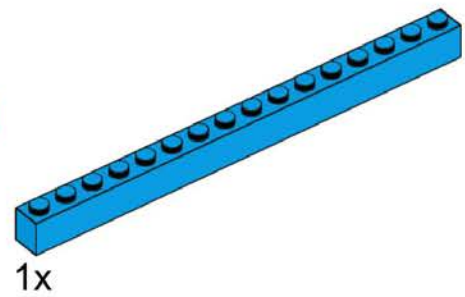
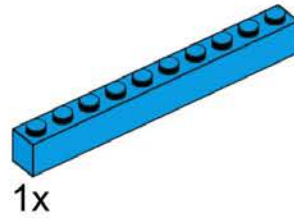
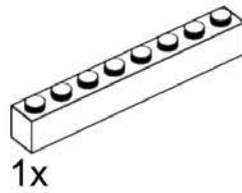
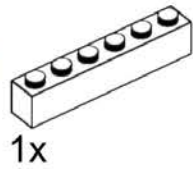
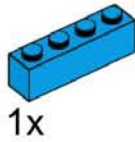
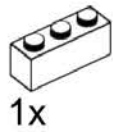

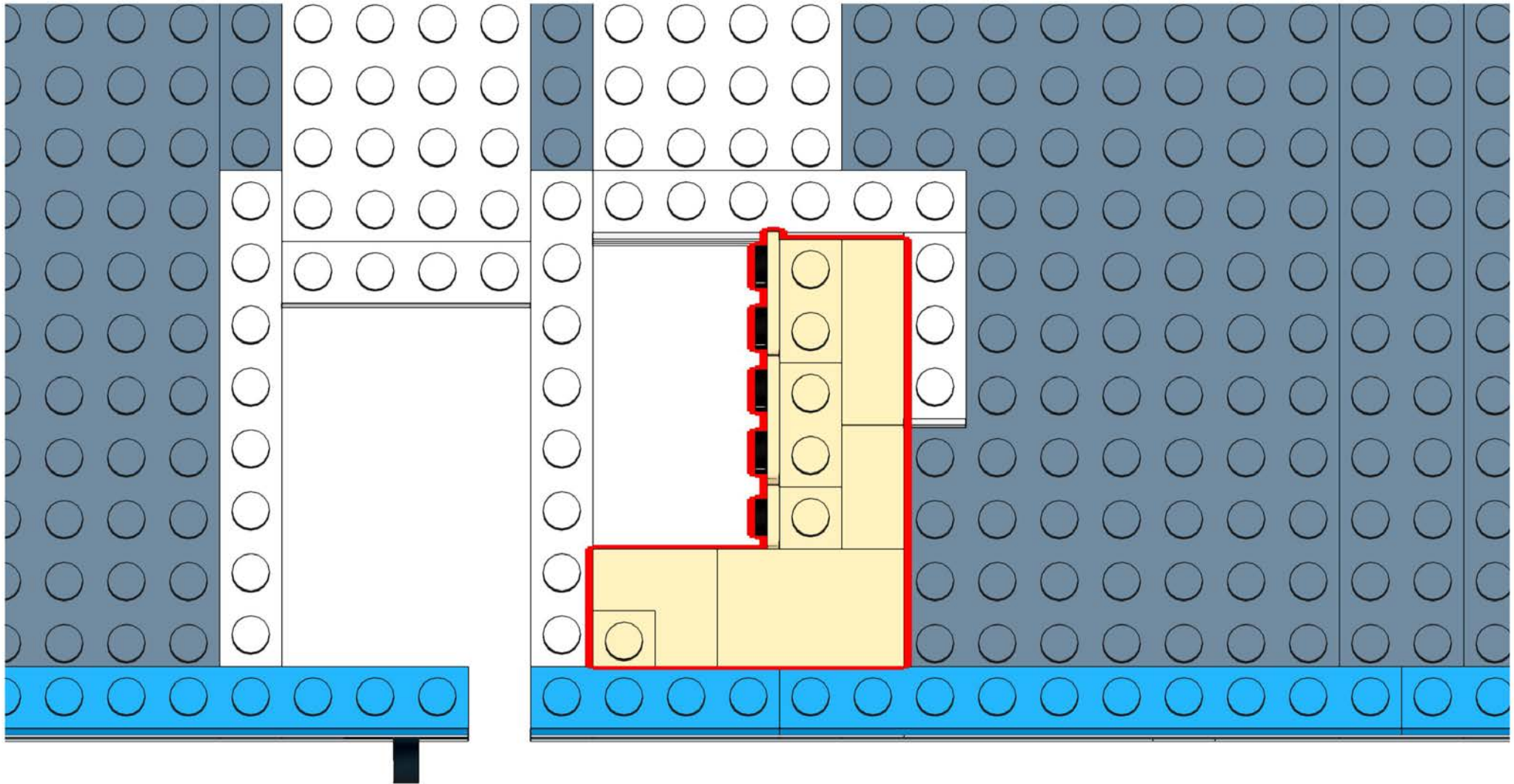

746

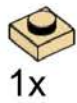

1x



1x



1x



1x



1x



1x



2x

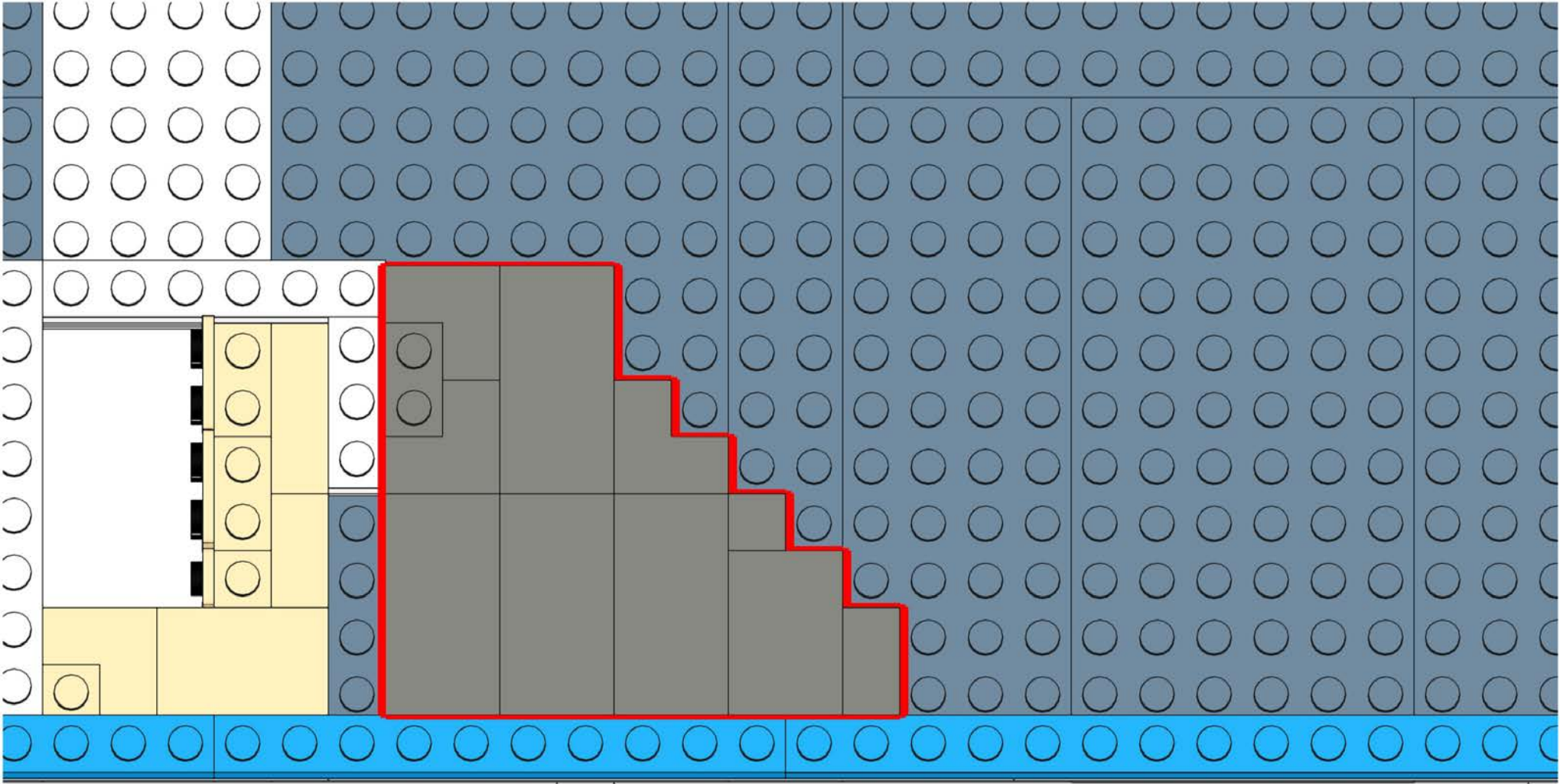

747

1x

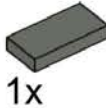

1x

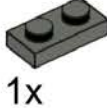

1x

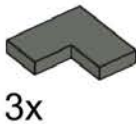

3x

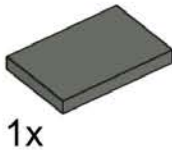

1x

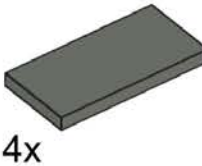

4x

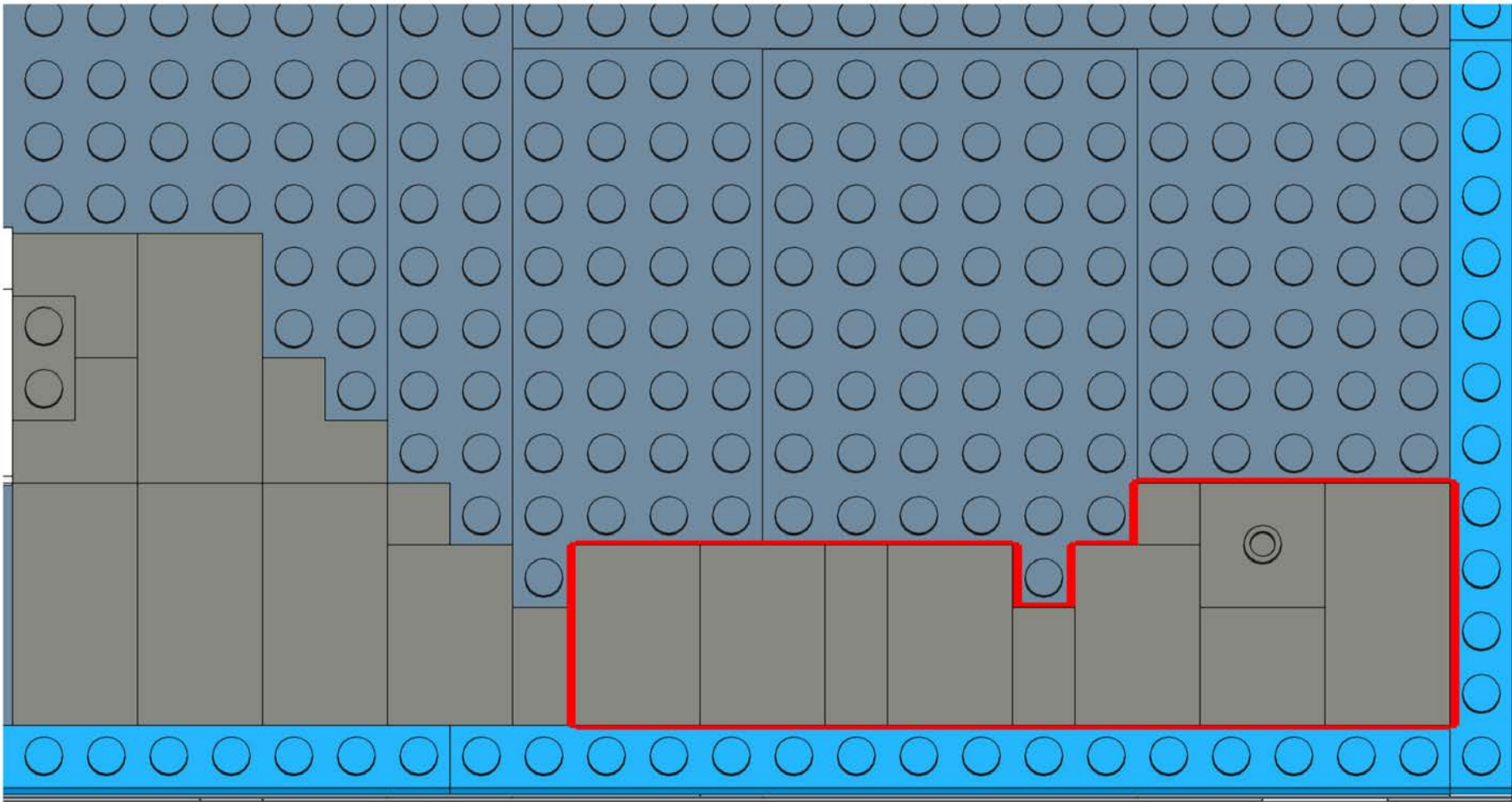

748

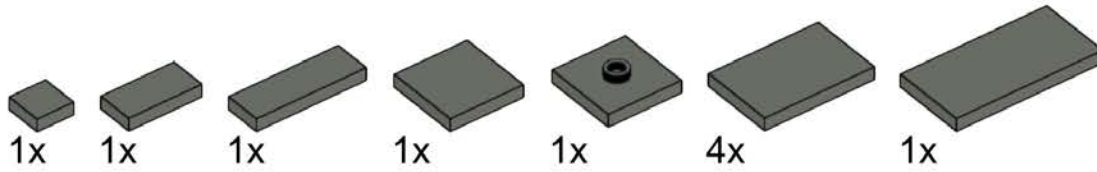



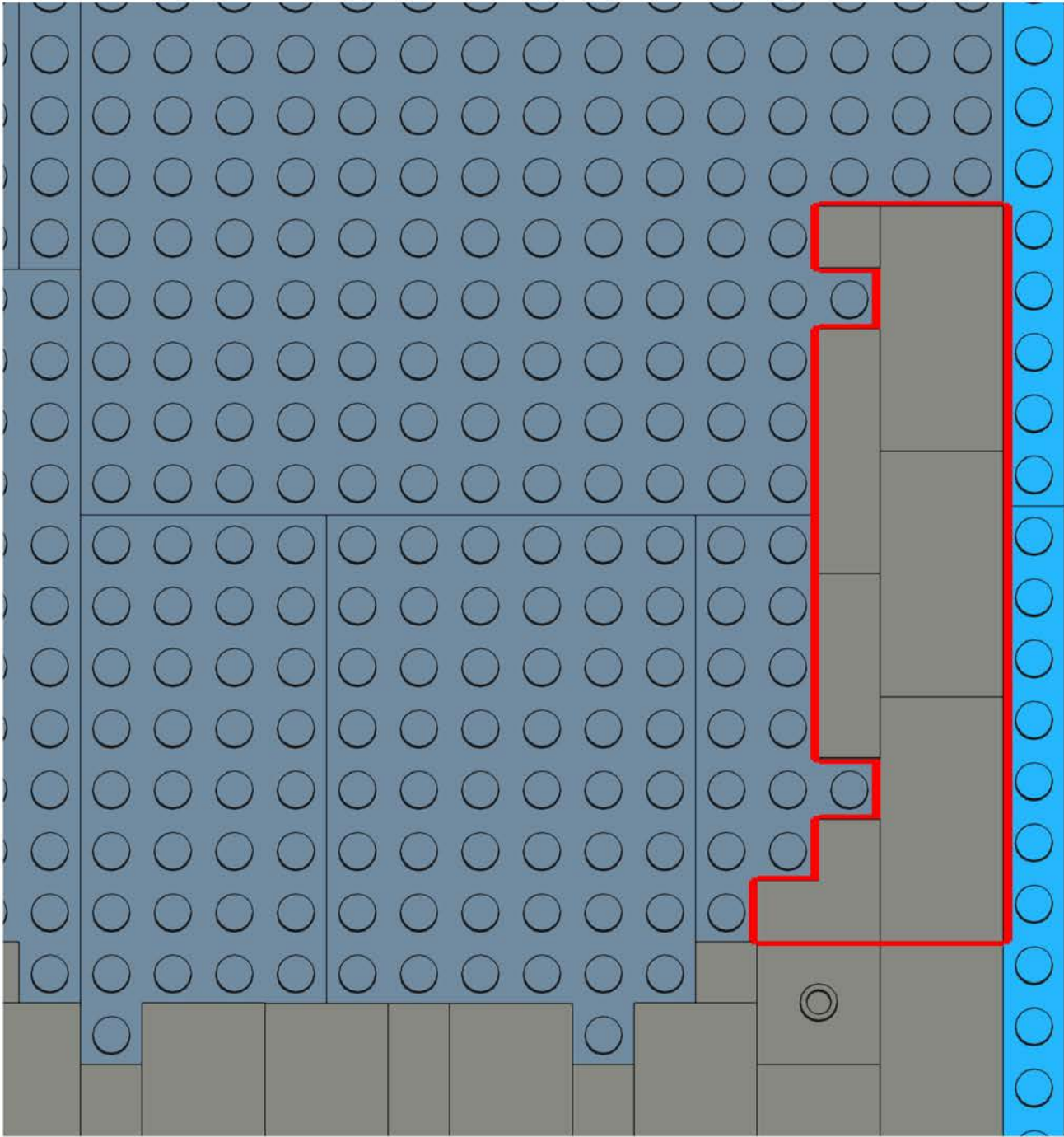

# 749

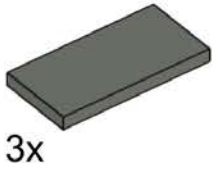
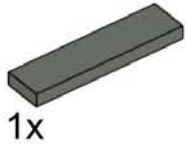
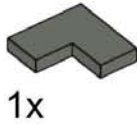
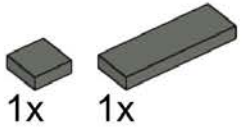

# 750

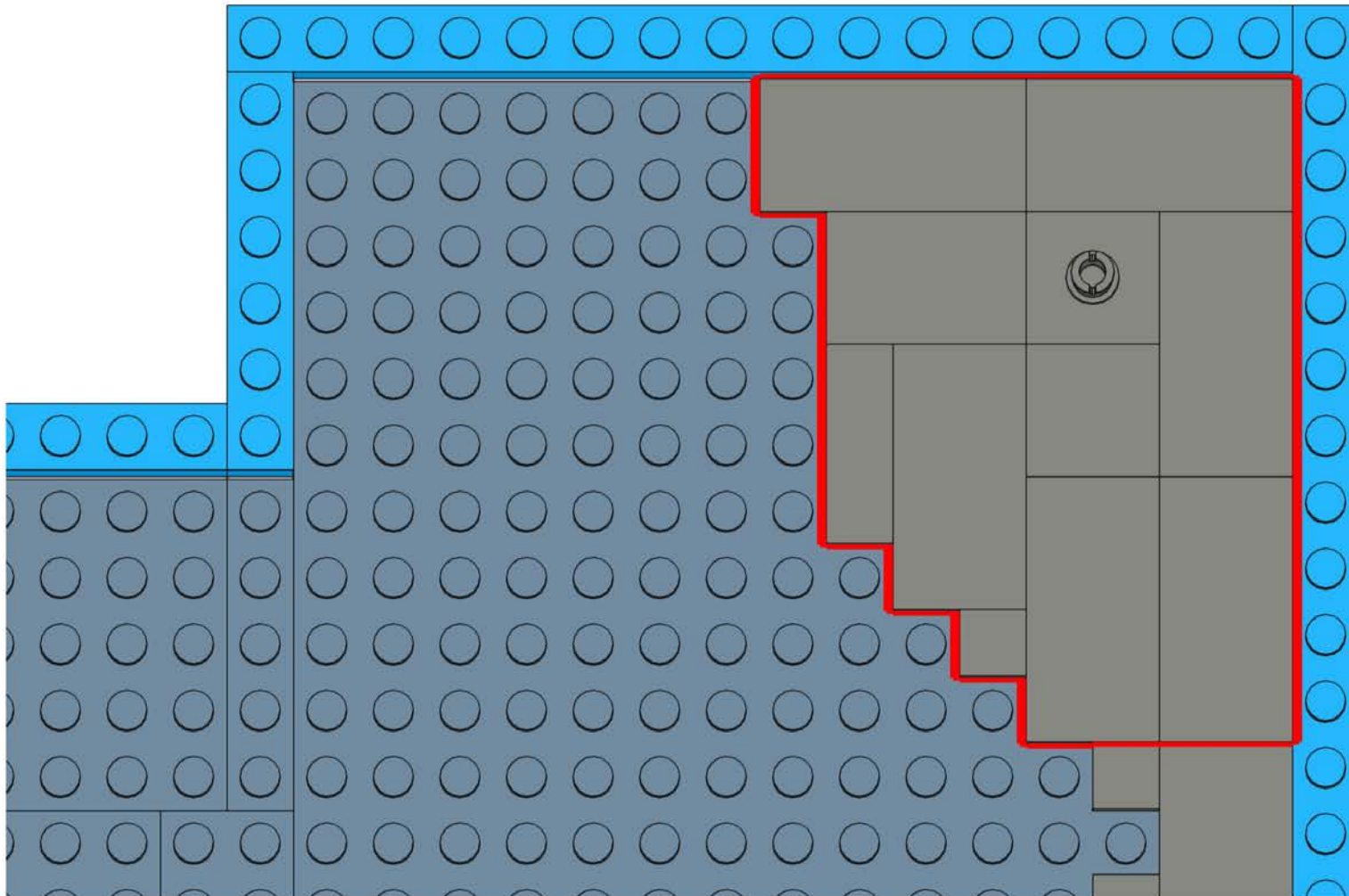
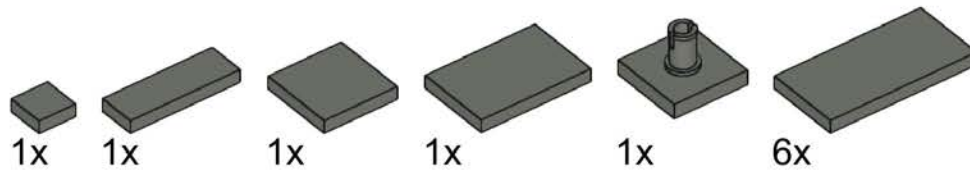

# 751

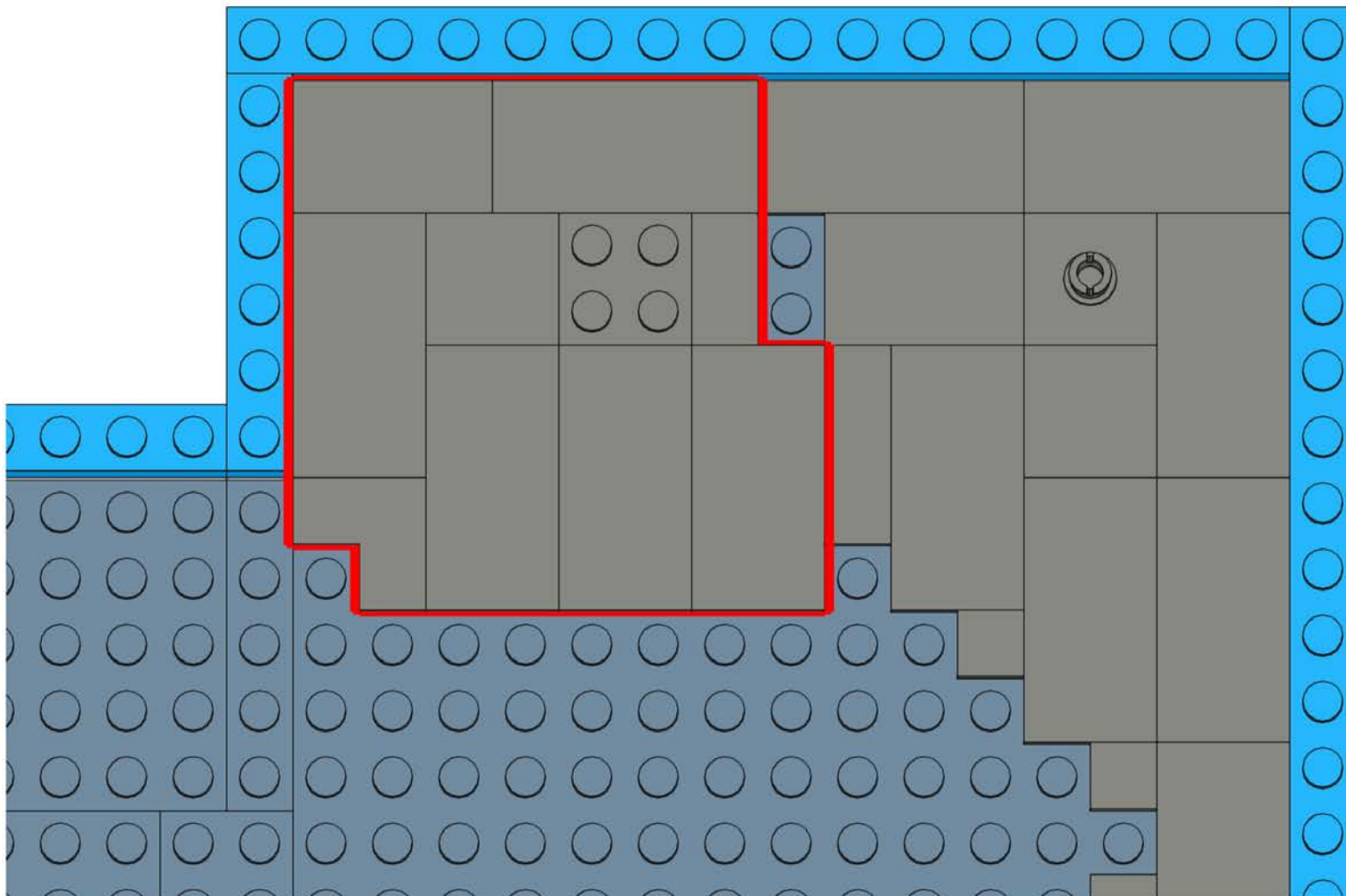
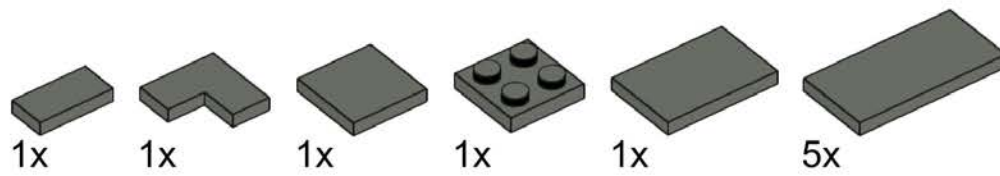

# 752

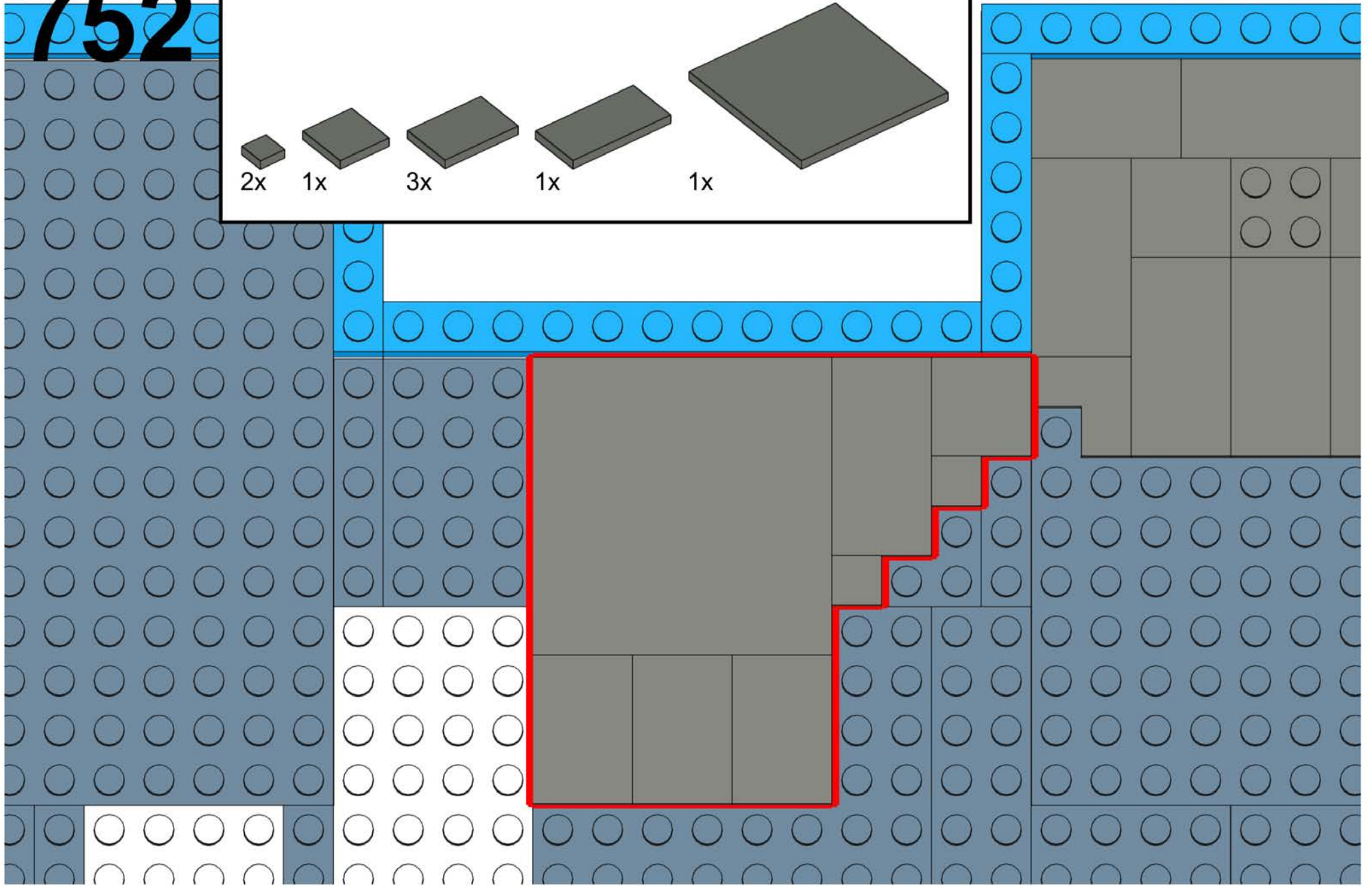
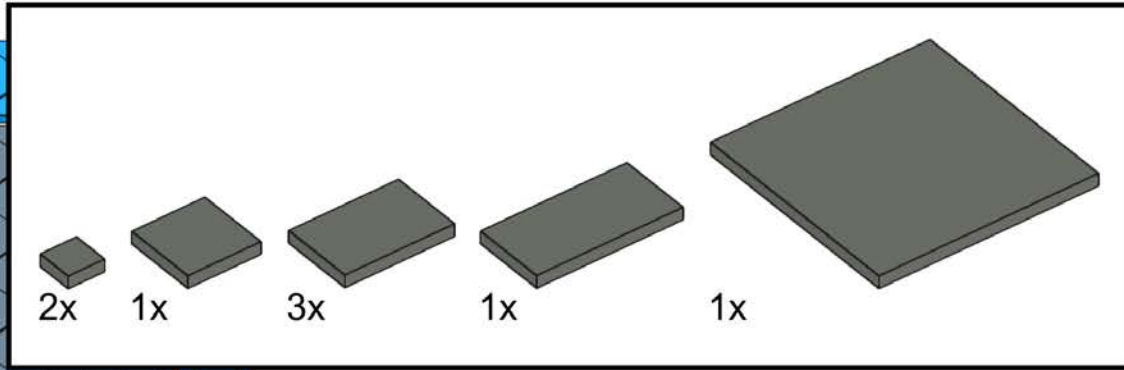

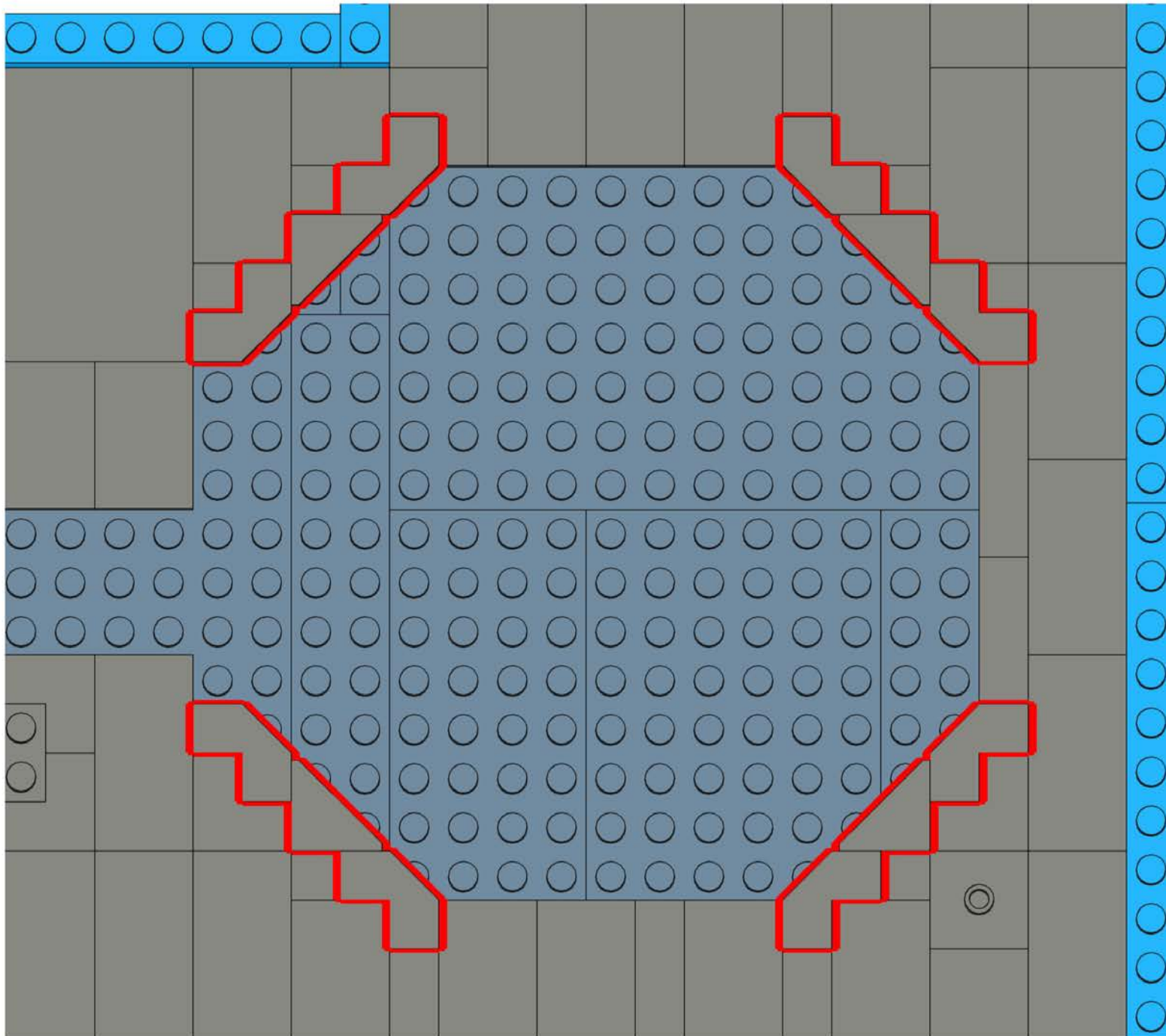

# 753



4x

8x

# 754

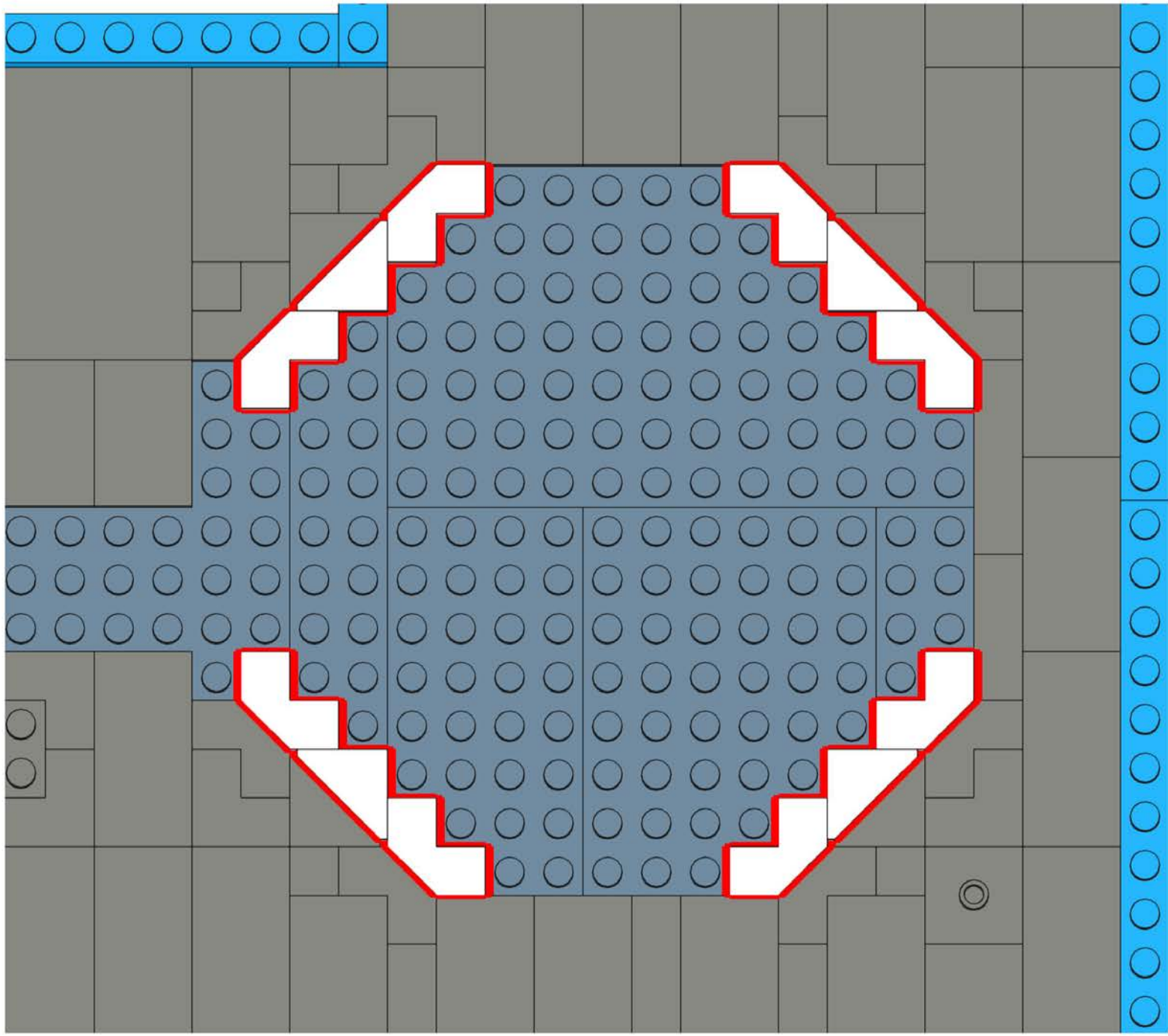
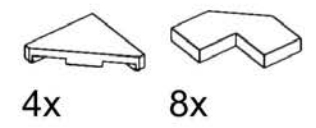

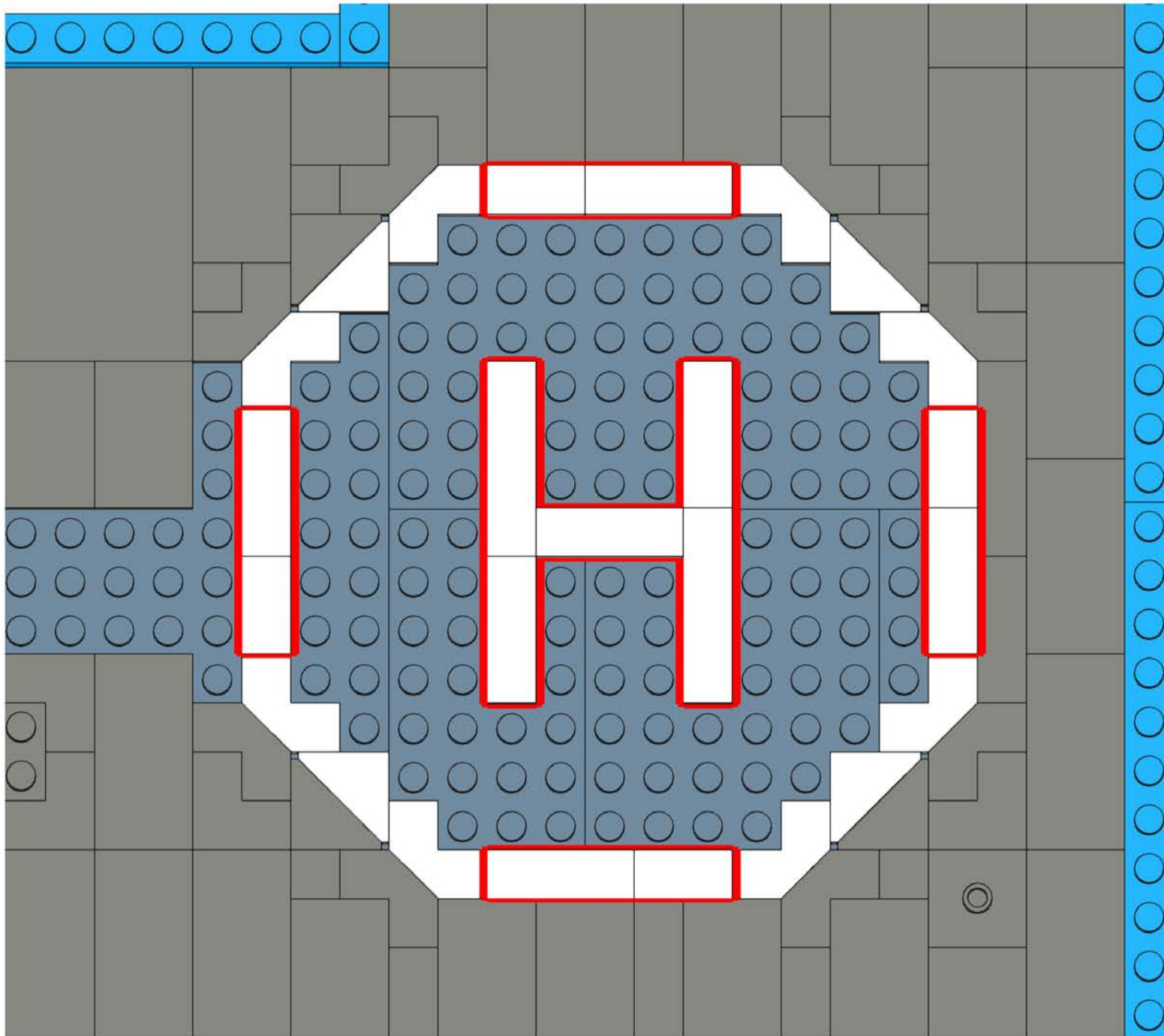



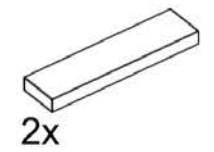
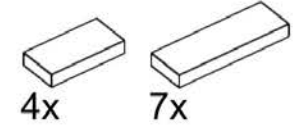

# 755

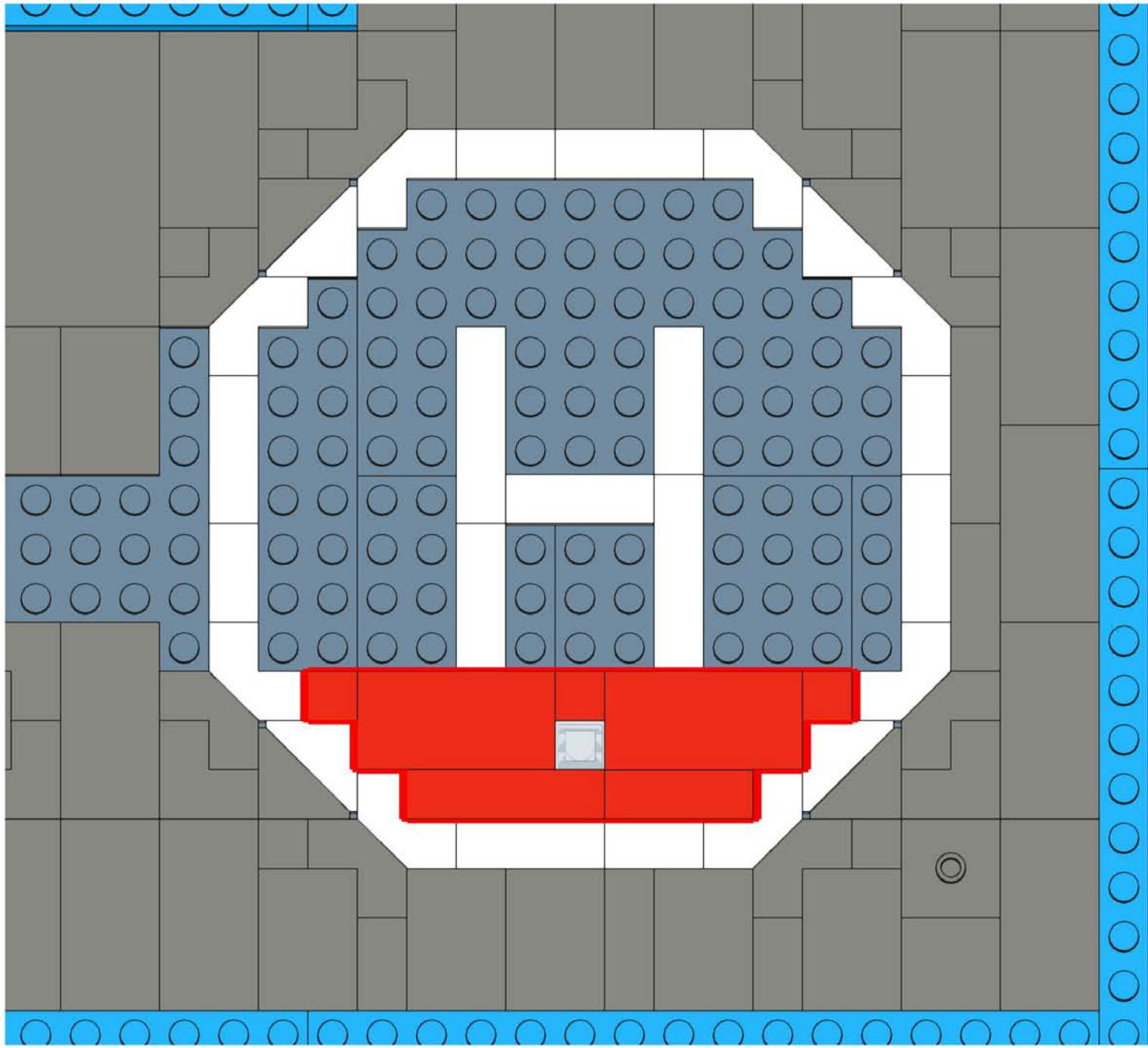

# 756



3x  1x 

1x 



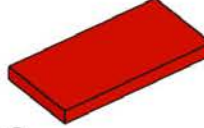

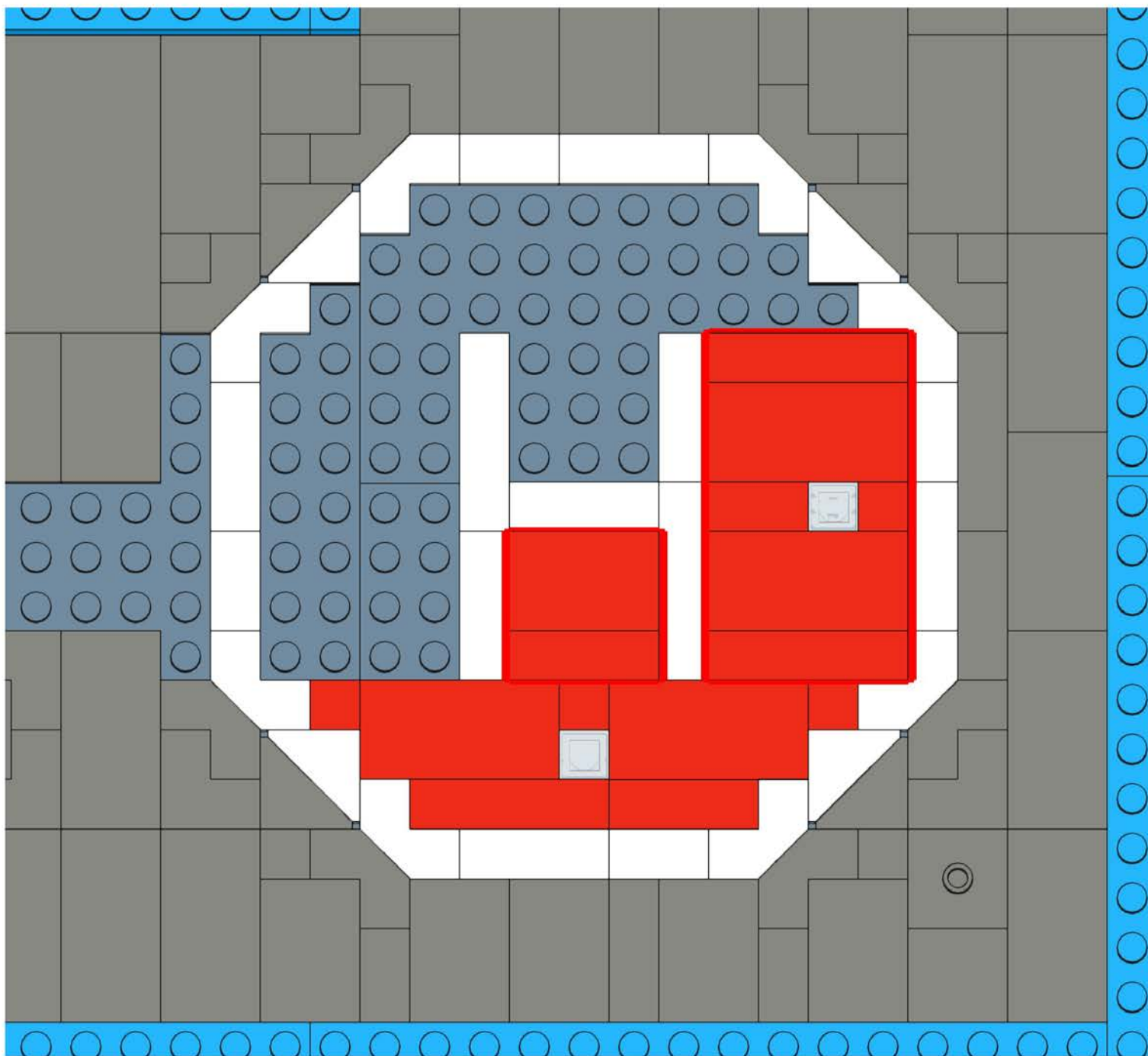

1x 

2x 



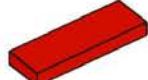

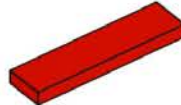



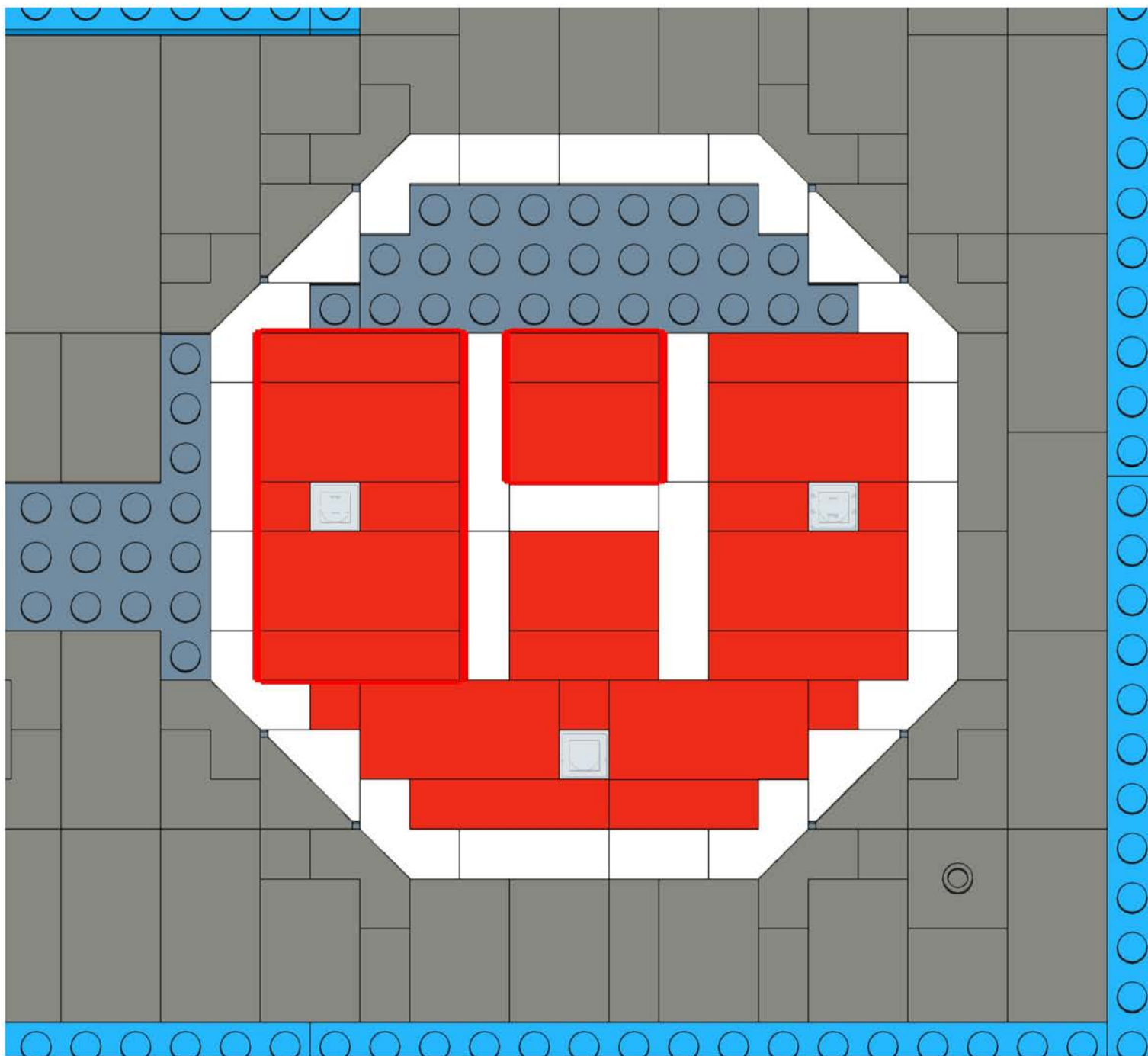

# 757

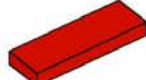

- 1x  1x  1x 
- 1x  1x 
- 2x 
- 2x 

# 758

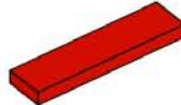

- 1x  1x  1x 
- 1x  1x 
- 2x 
- 2x 

# 759

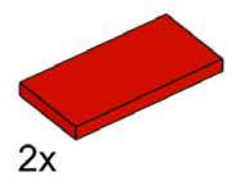
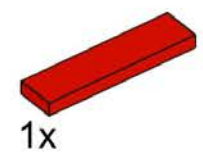
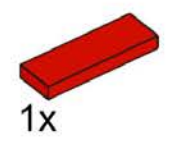
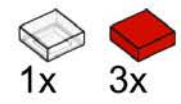
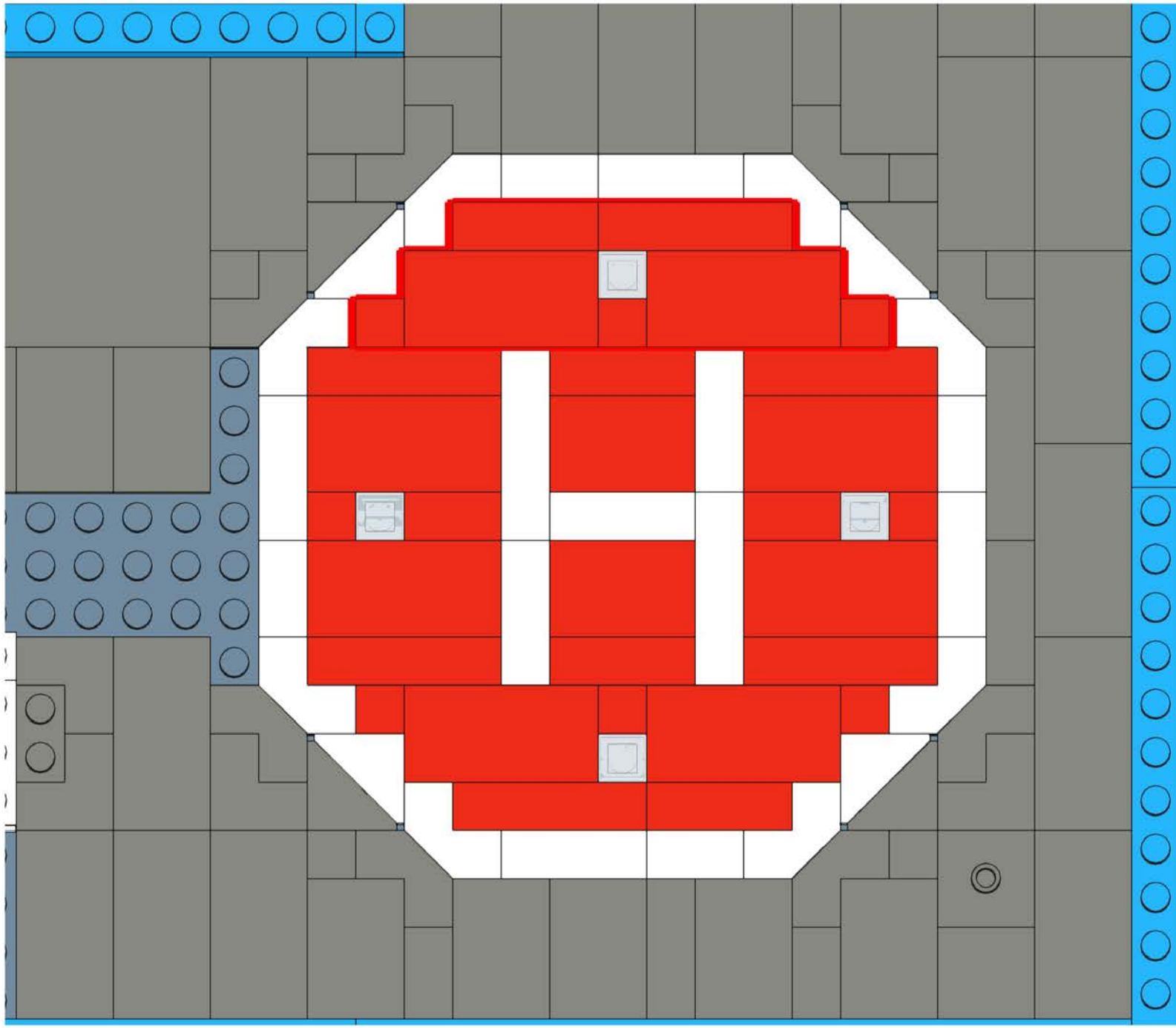

# 760

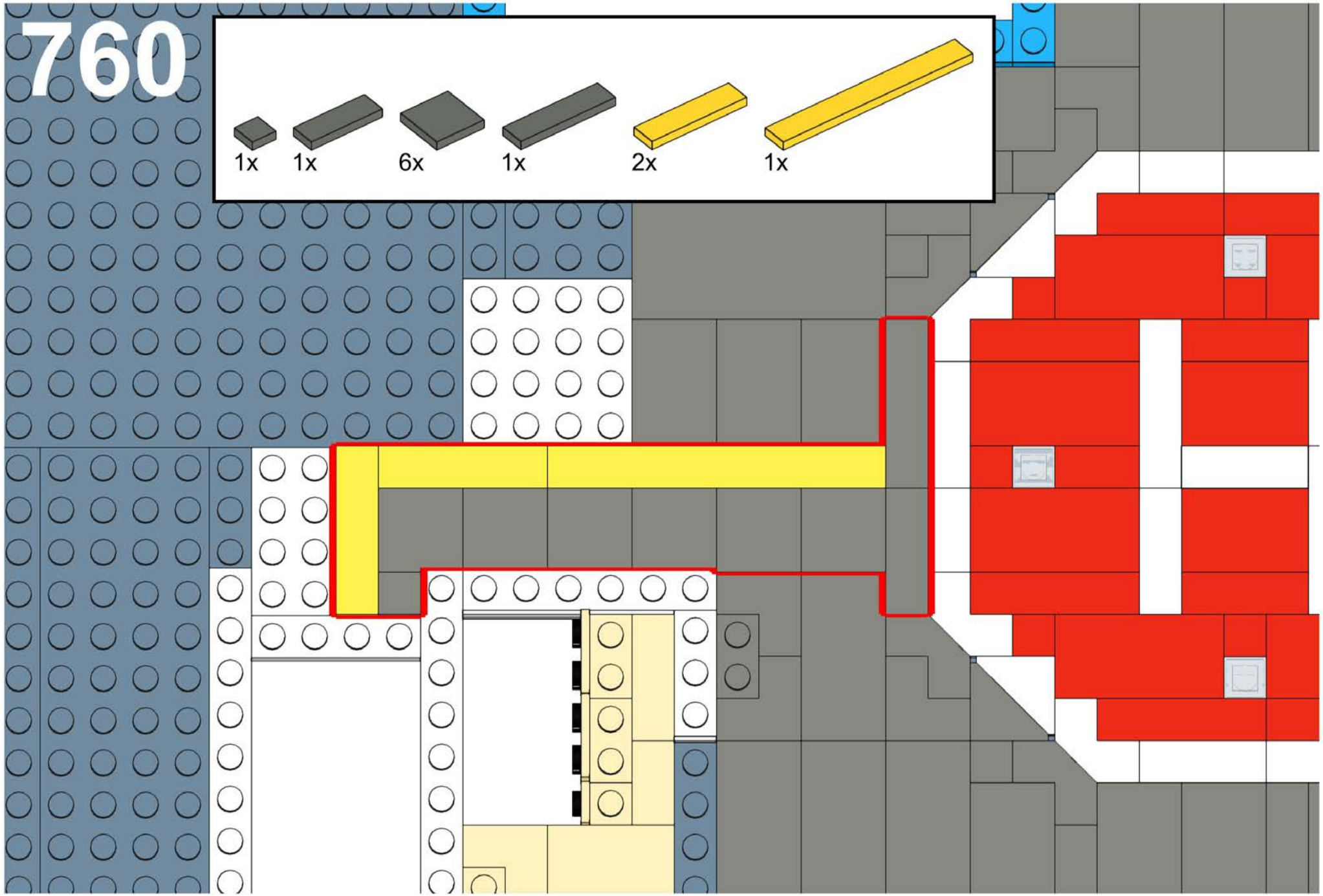
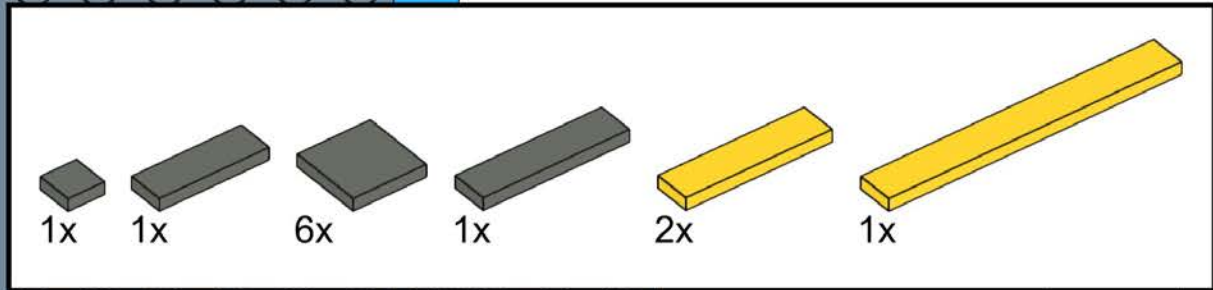

# 761



4x



1x



4x



5x

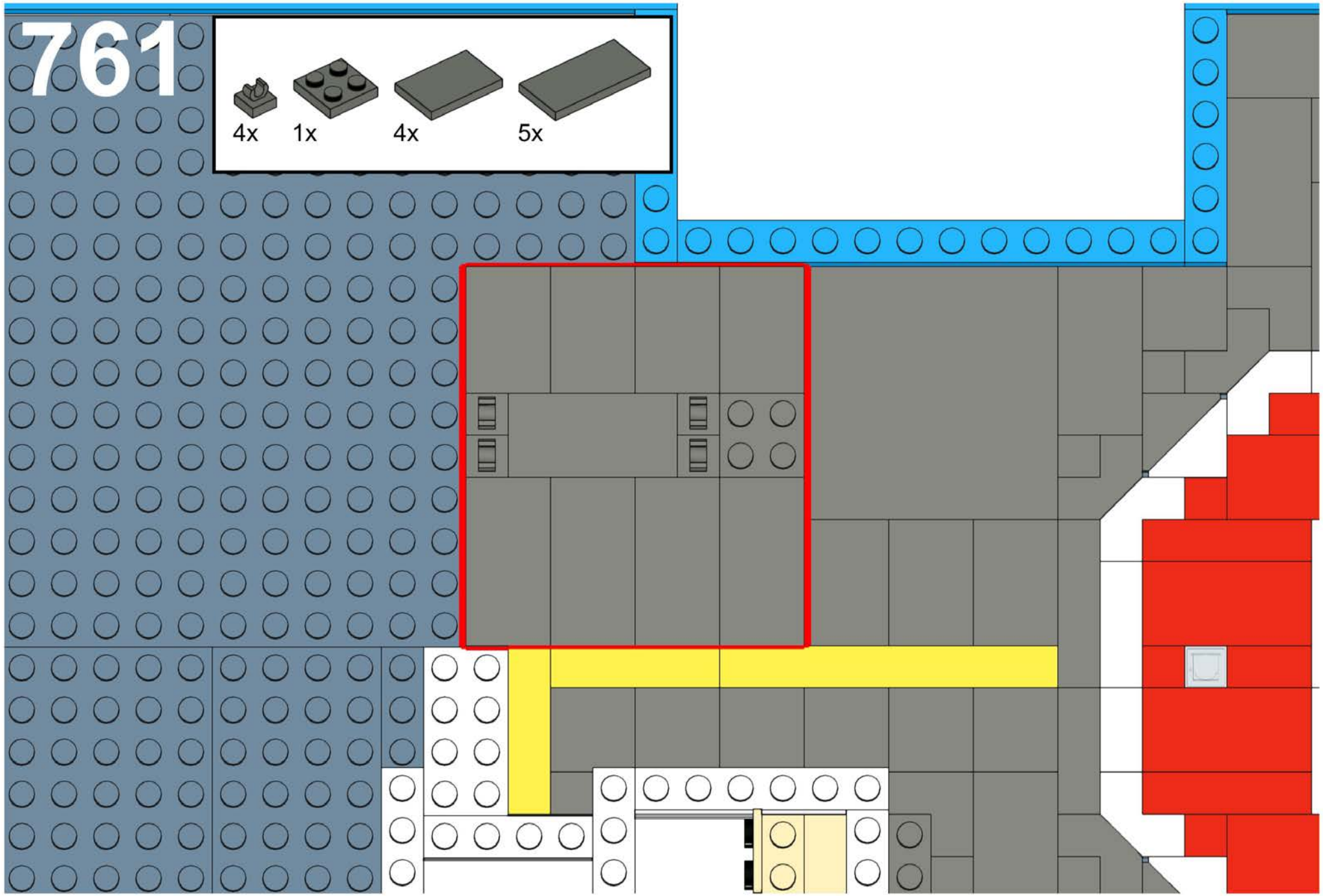

# 762

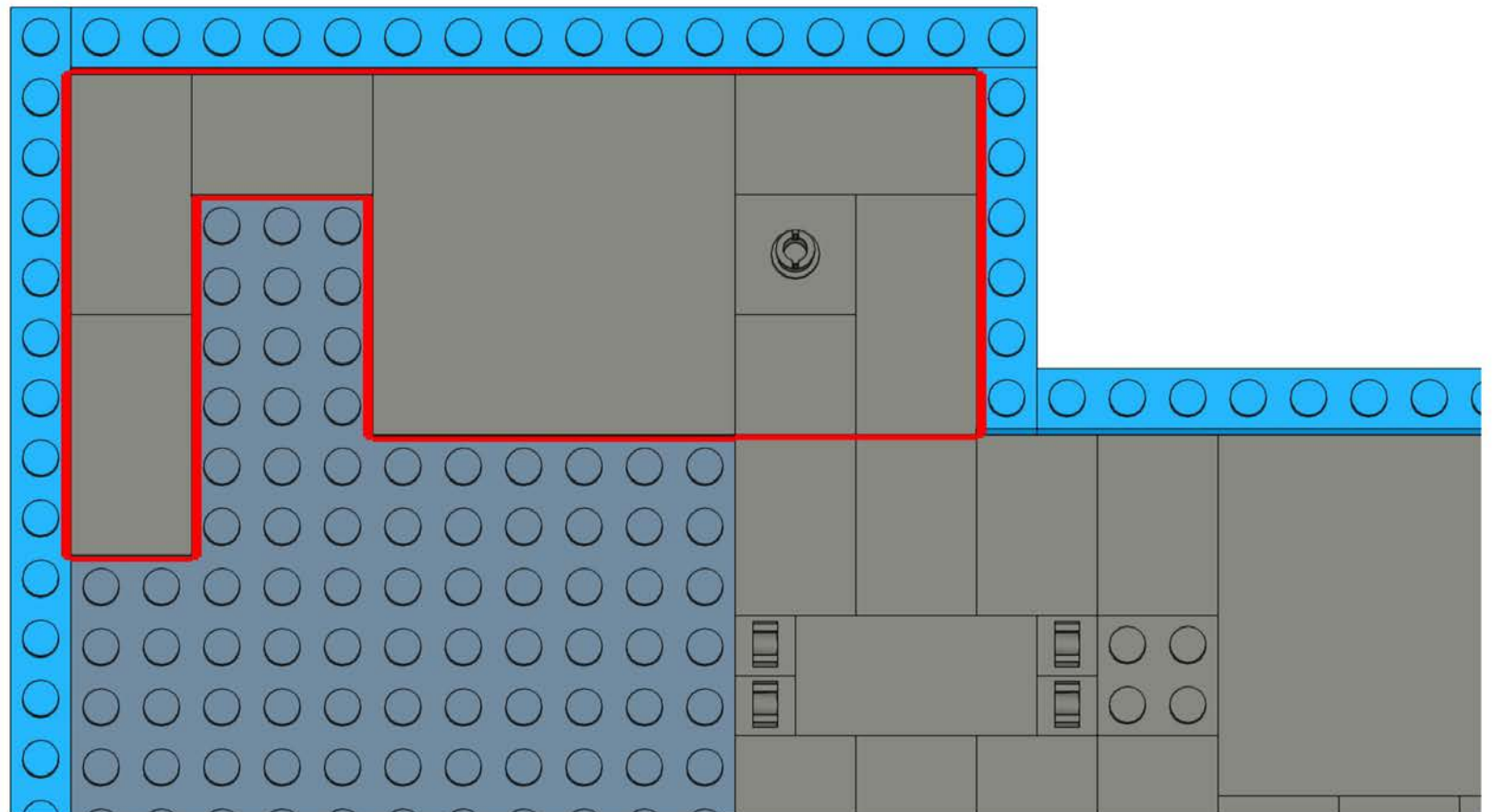
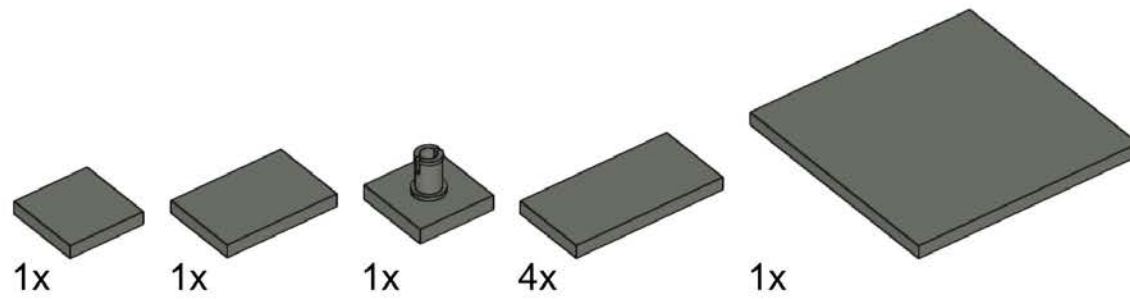

# 763

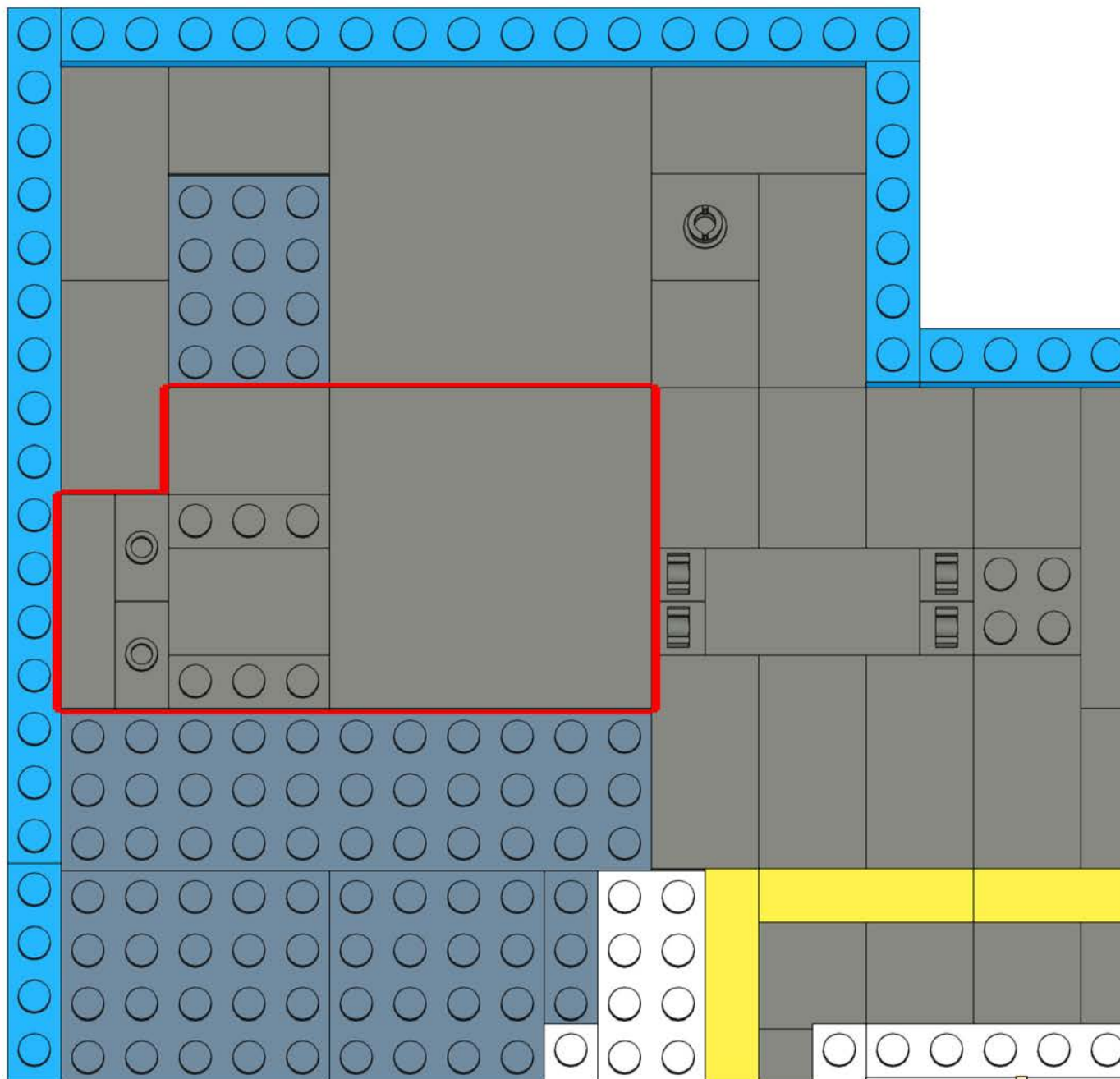
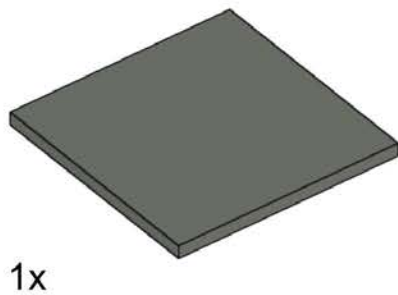
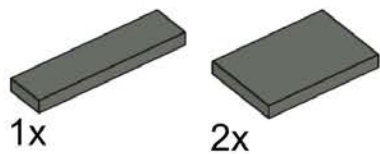
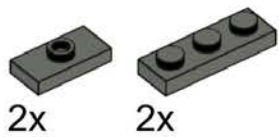

# 764

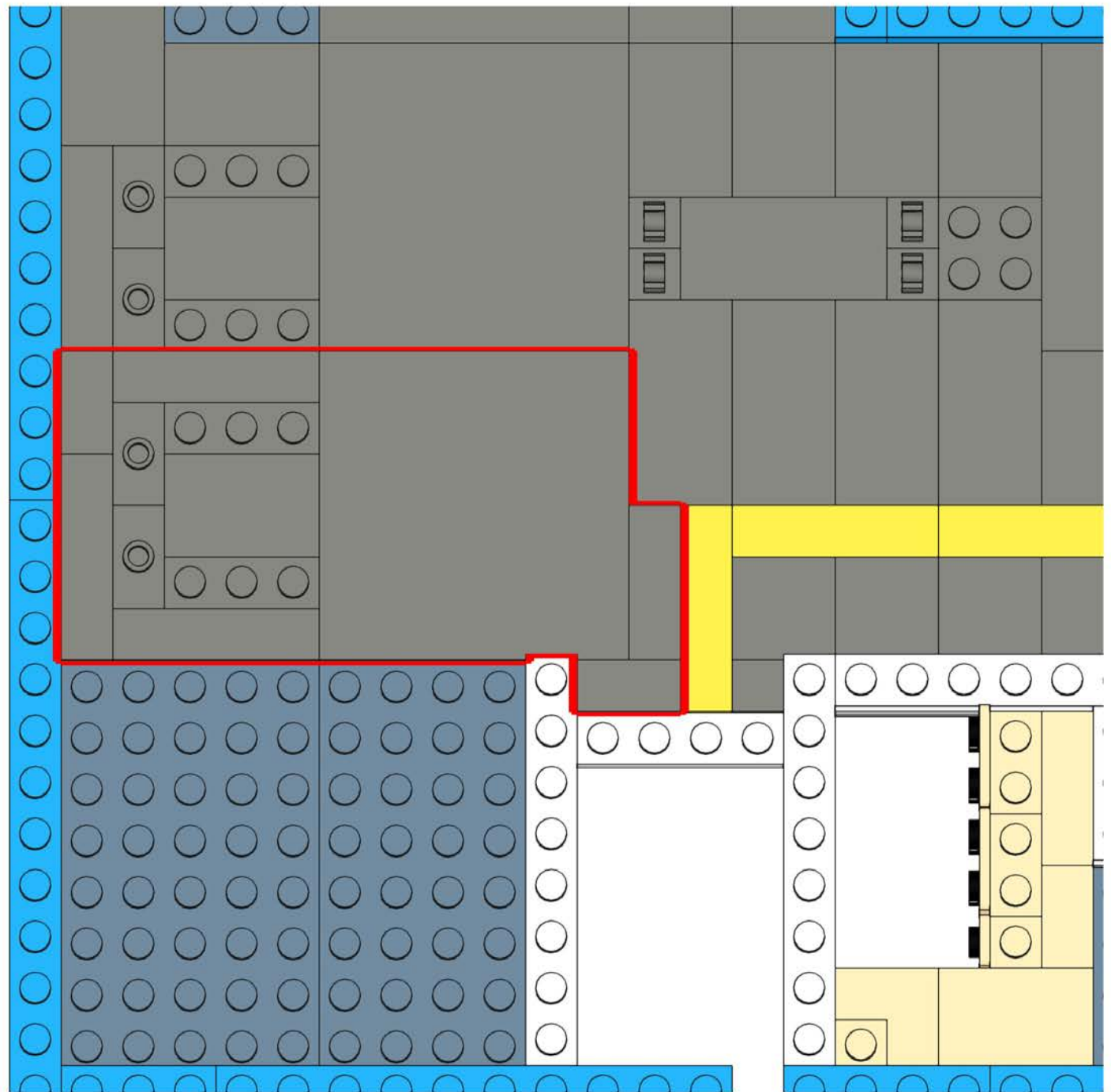
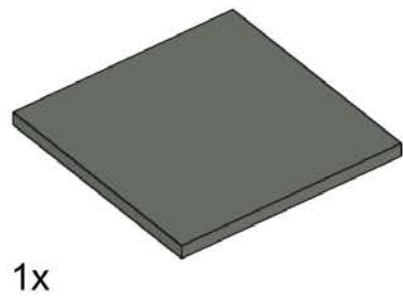
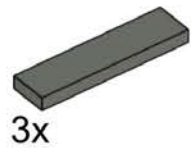
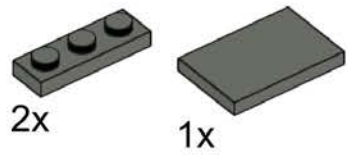
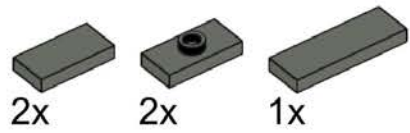



# 765



6x 2x

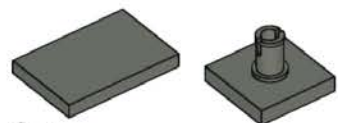



2x 2x

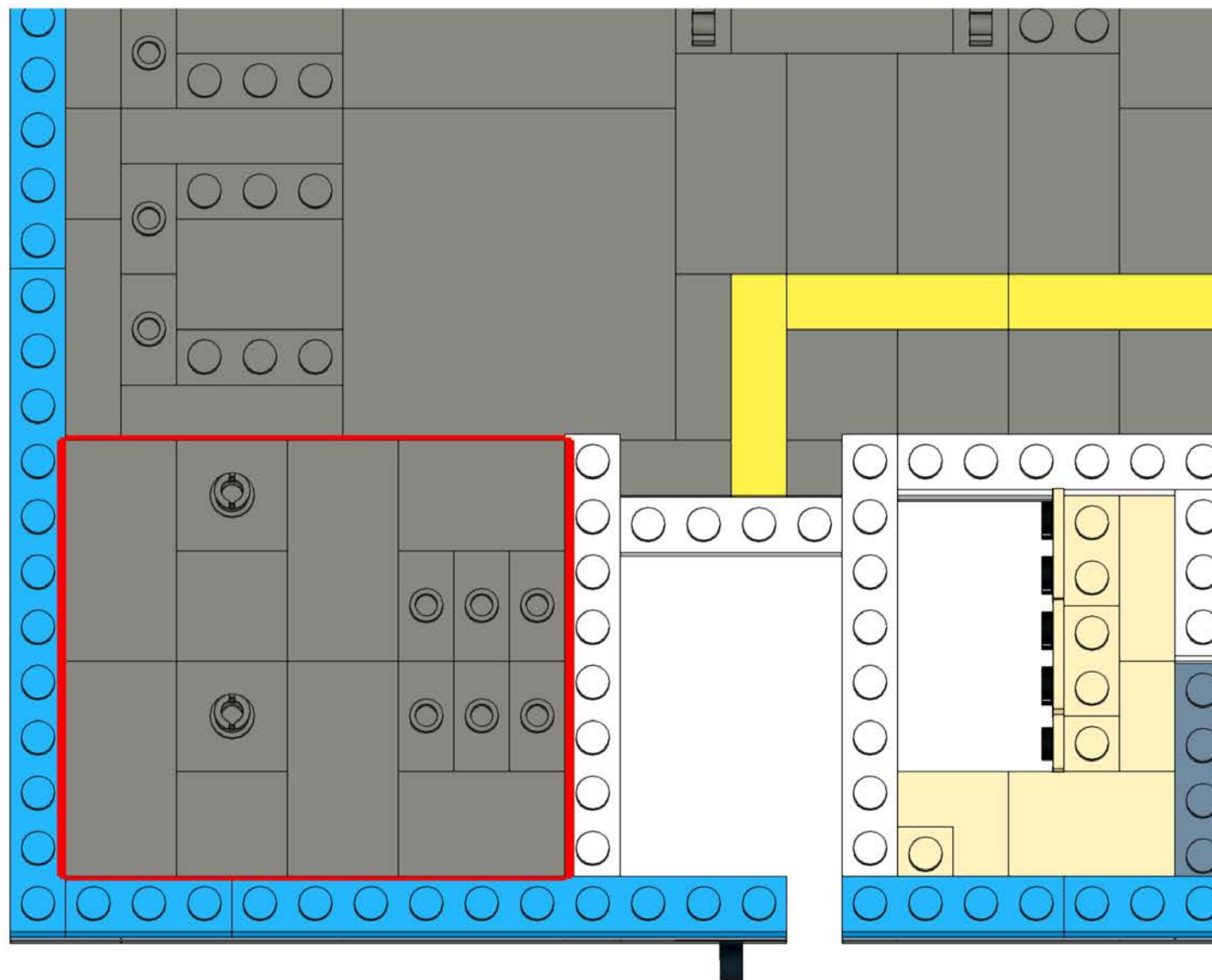

4x

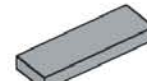
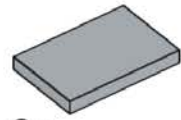

# 766

- 1x 
- 1x 
- 1x 
- 1x 
- 2x 

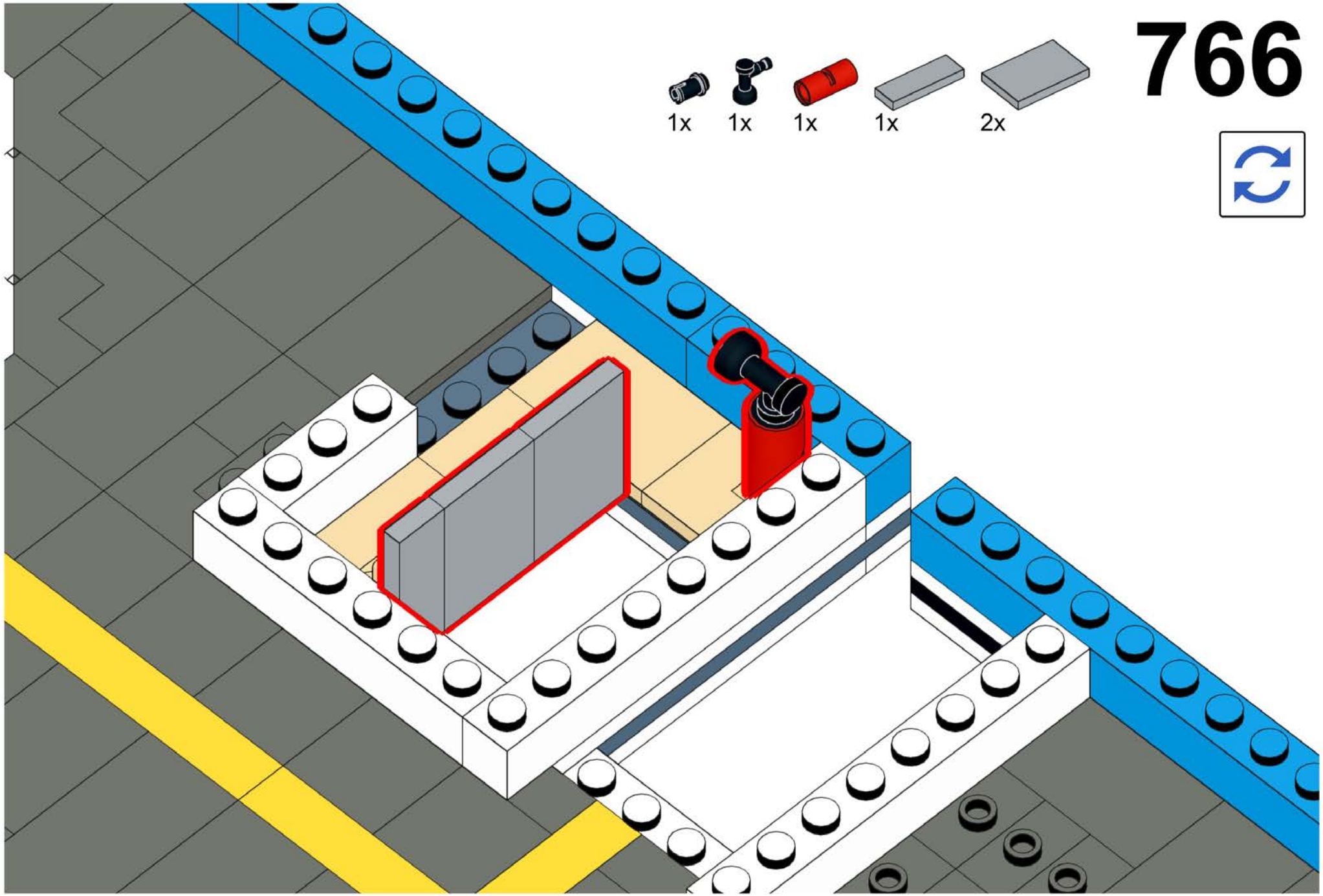

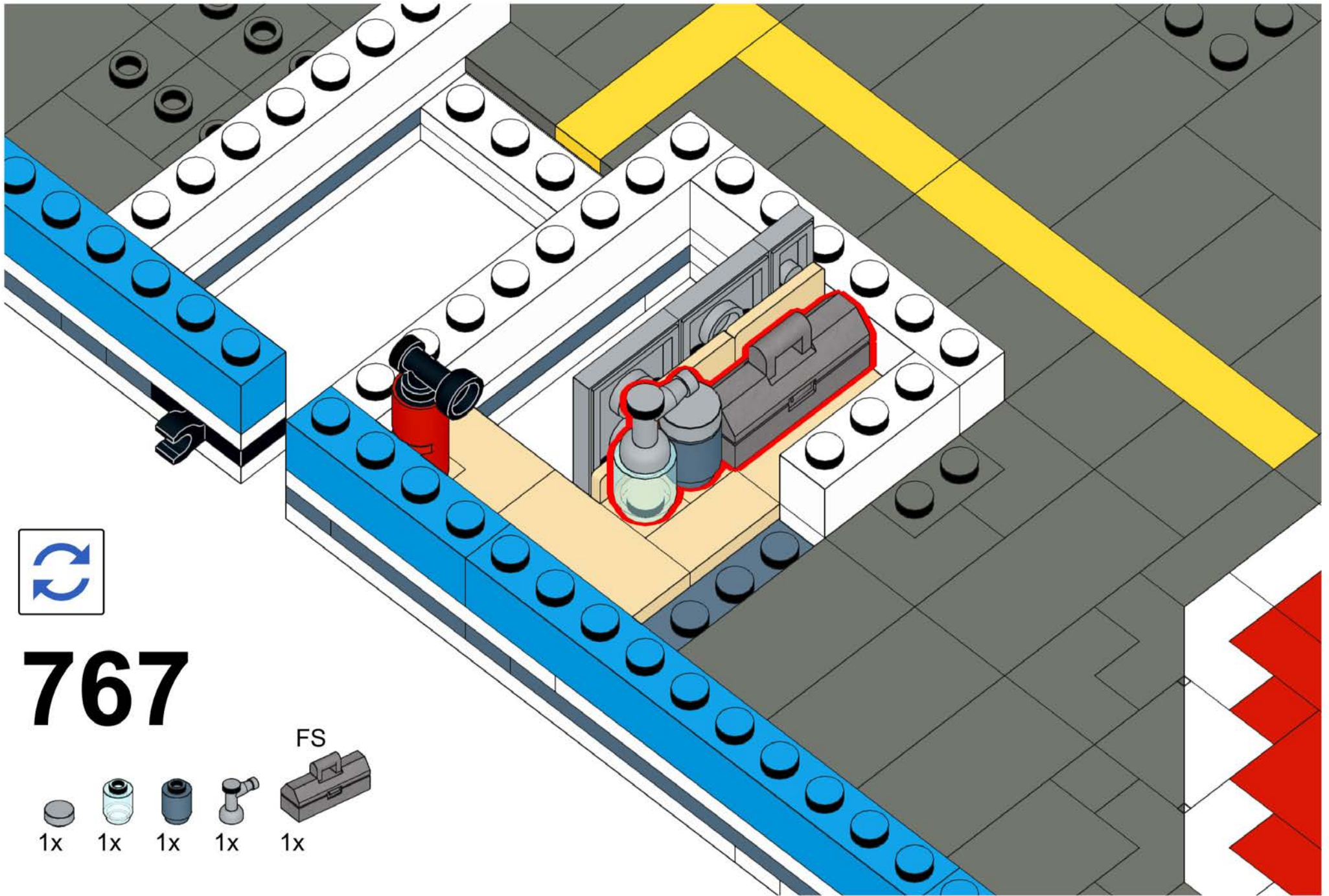

767

FS



1x



1x



1x



1x

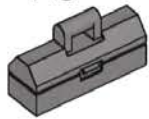

1x

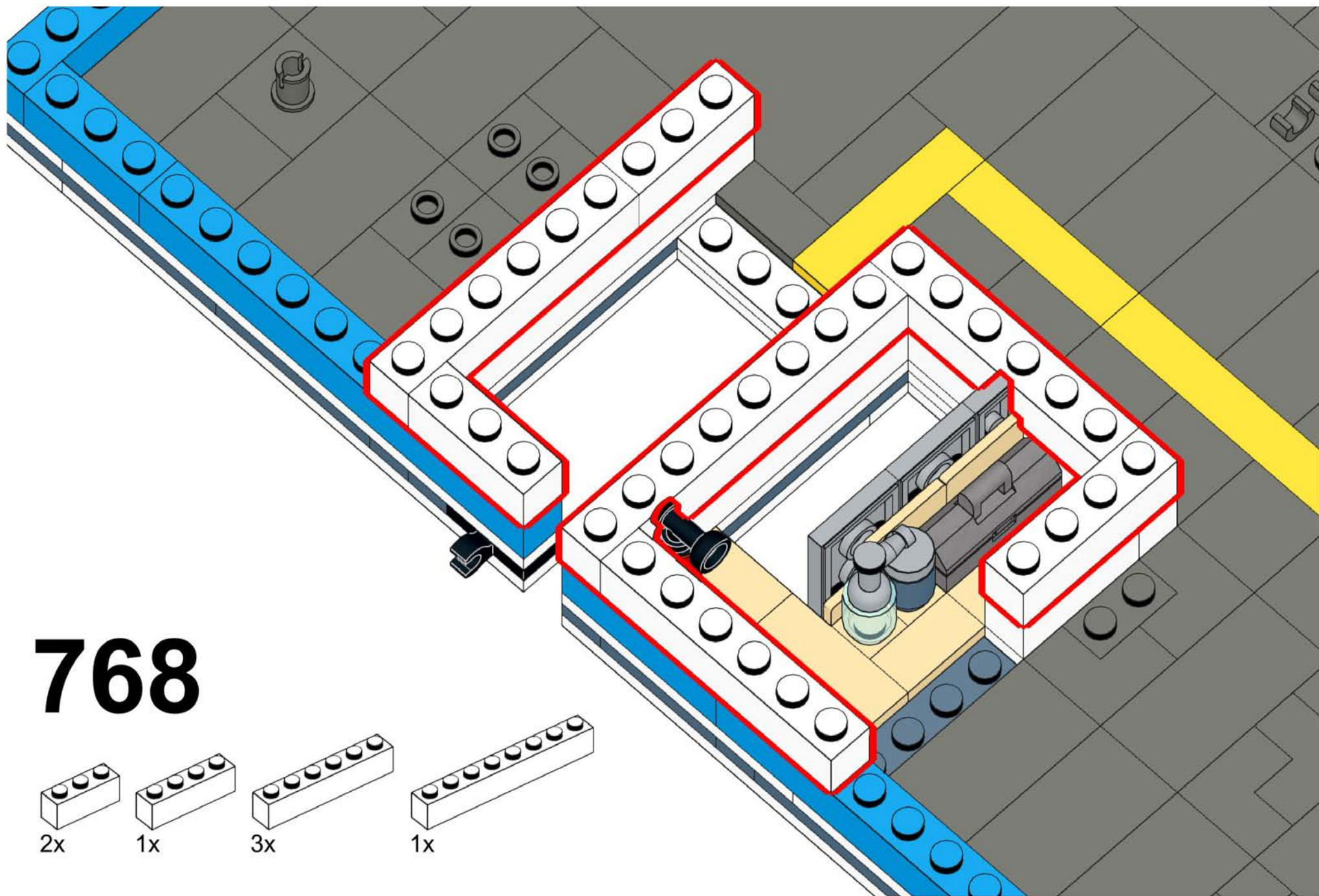

**768**

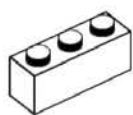

2x

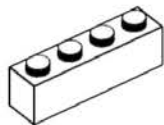

1x

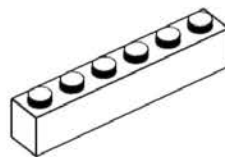

3x

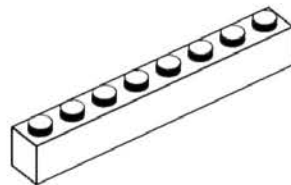

1x

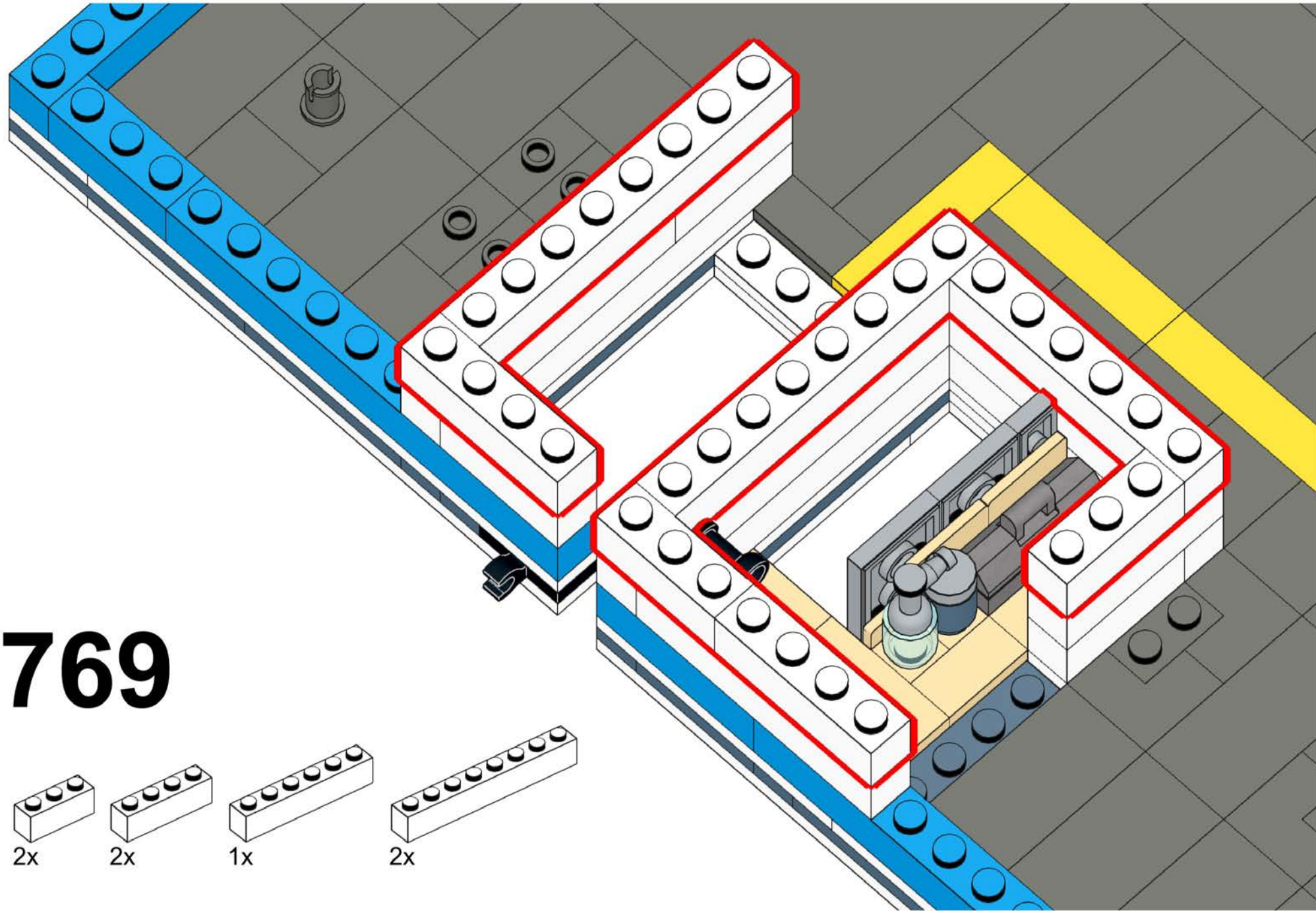

769

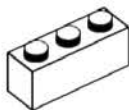

2x

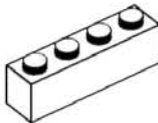

2x

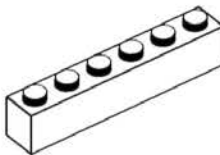

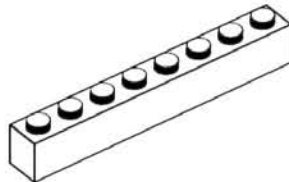

1x



2x

# 770

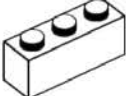
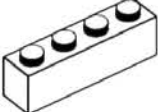
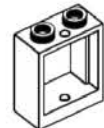
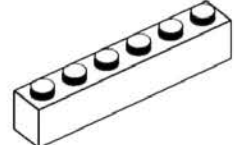
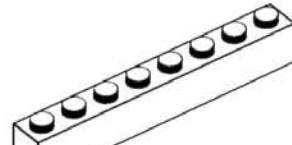
- 1x 
- 1x 
- 3x 
- 1x 
- 1x 
- 2x 
- 1x 

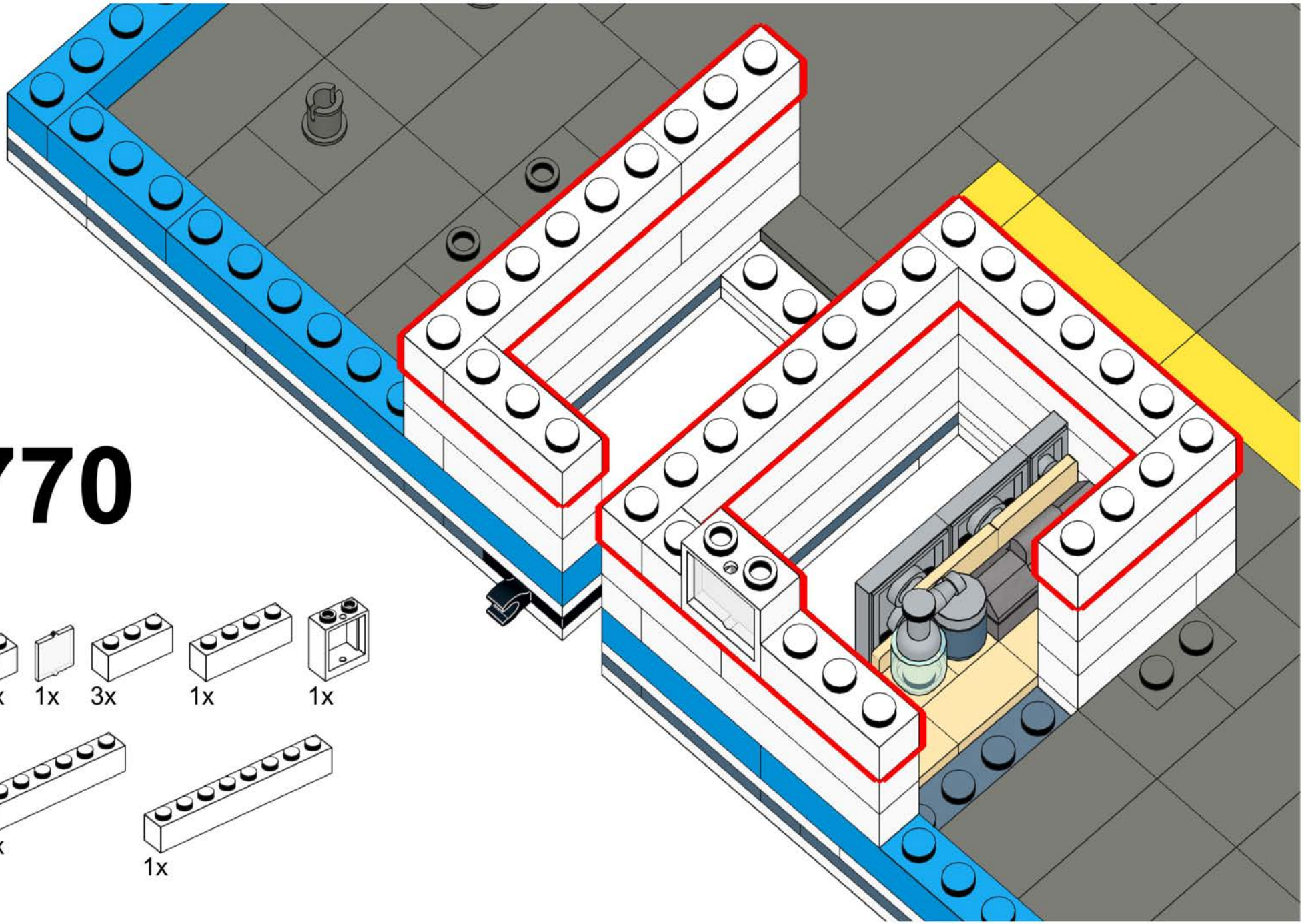

# 771

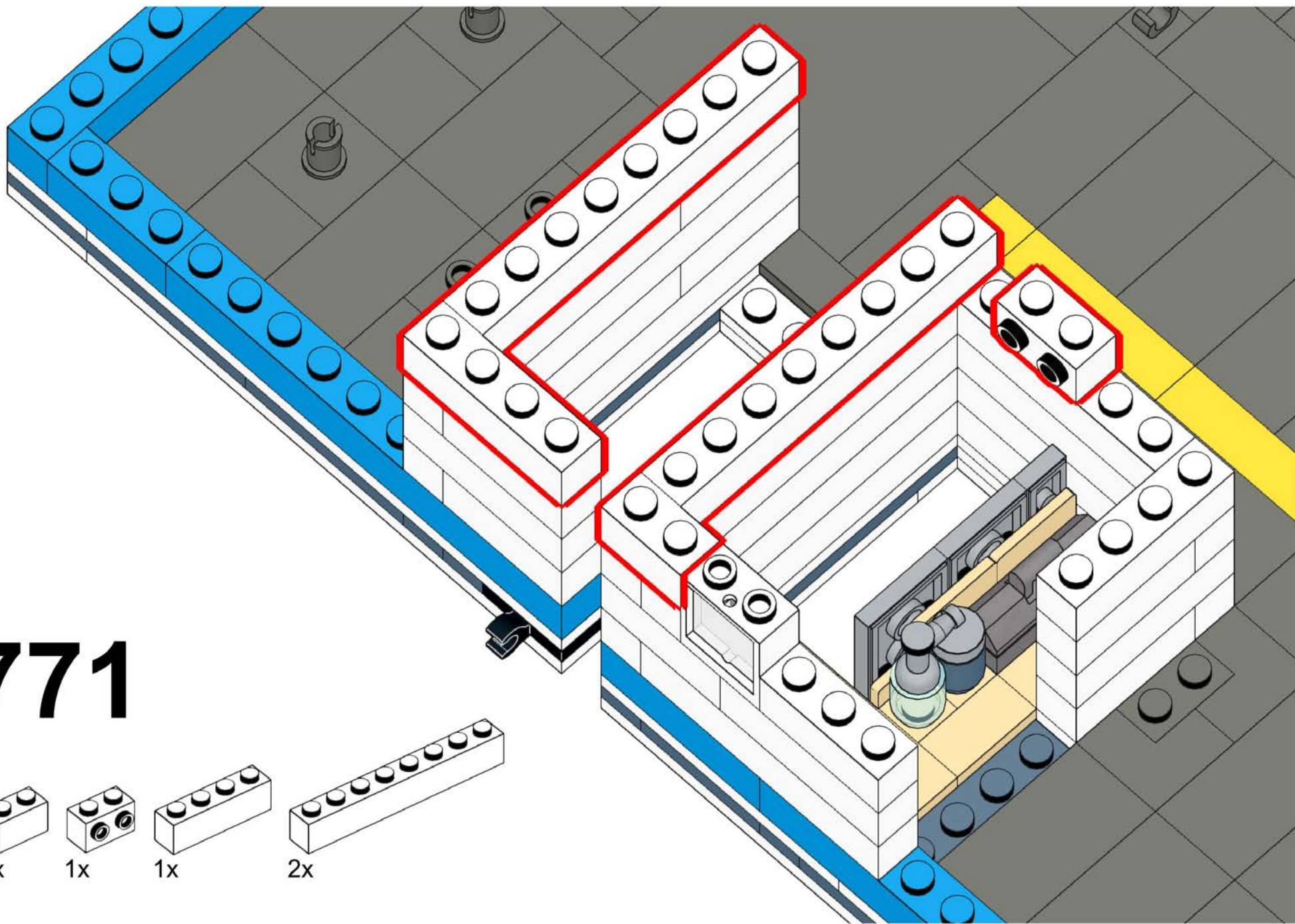
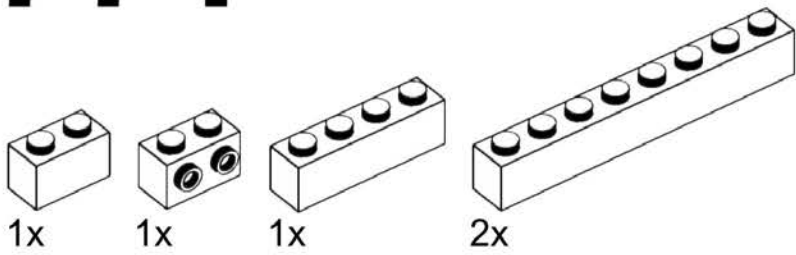

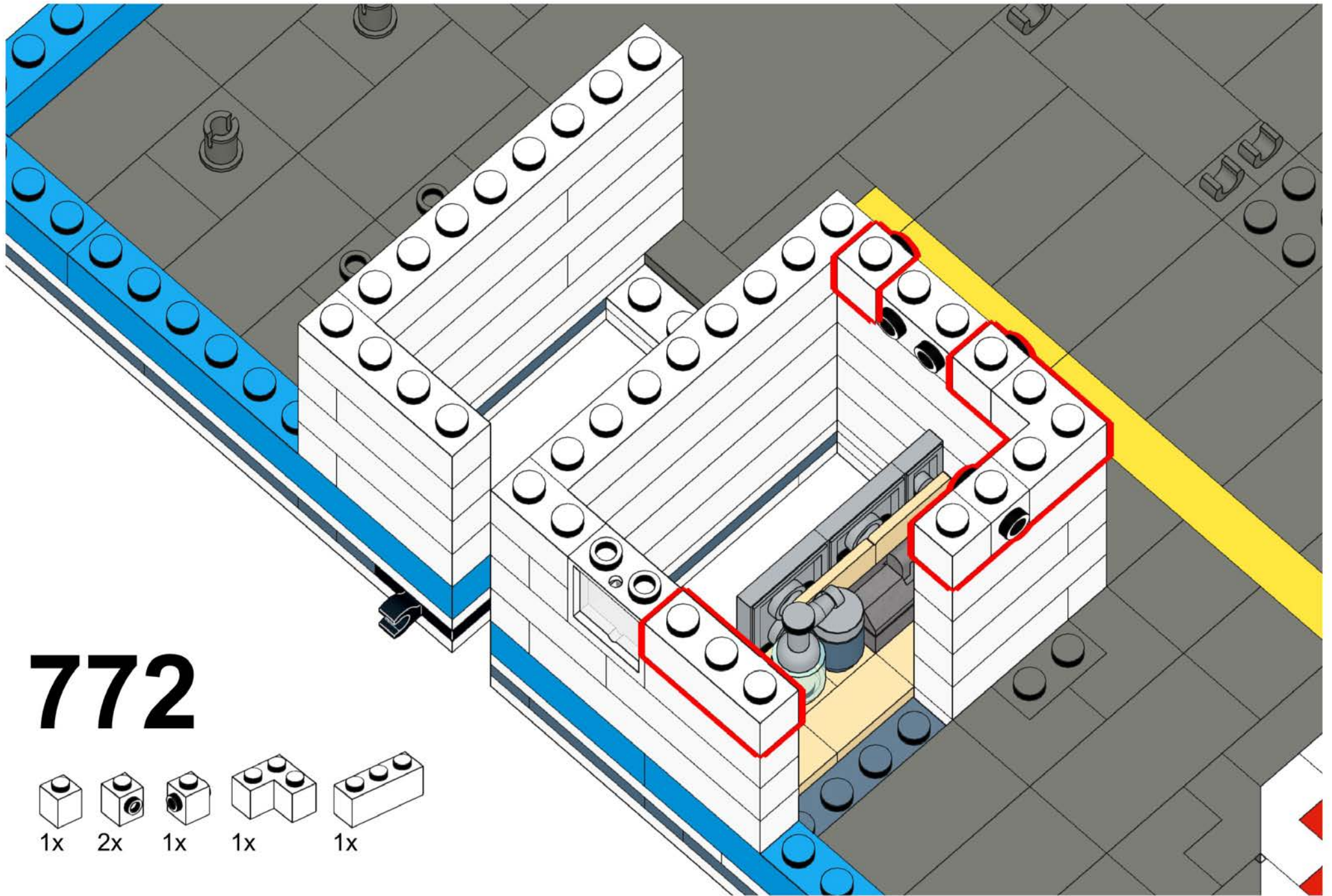



# 773

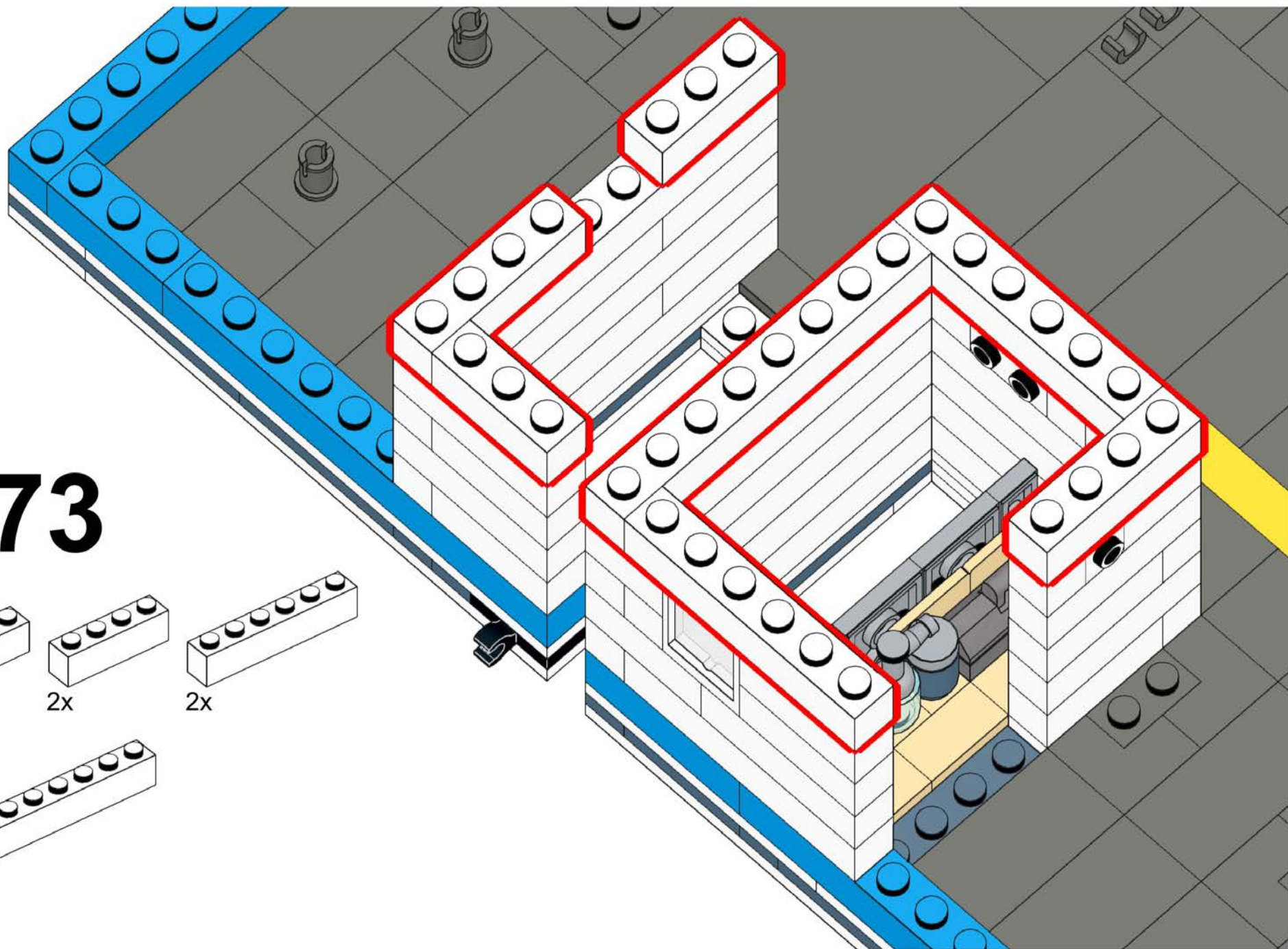
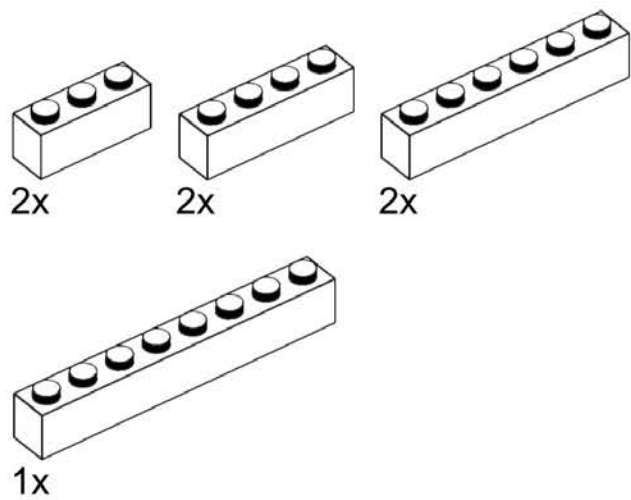

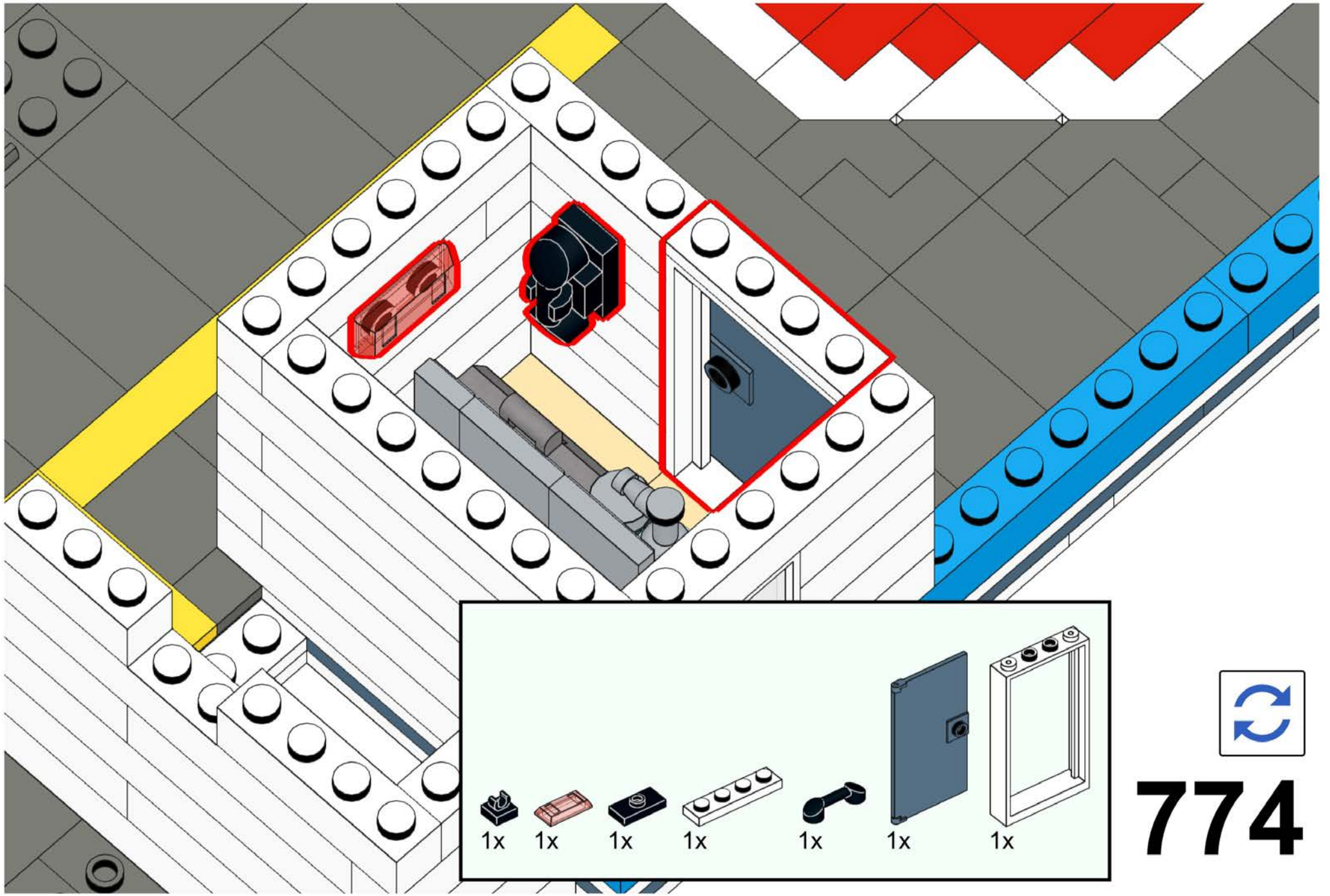

1x	1x	1x	1x	1x	1x	1x



# 774

# 775

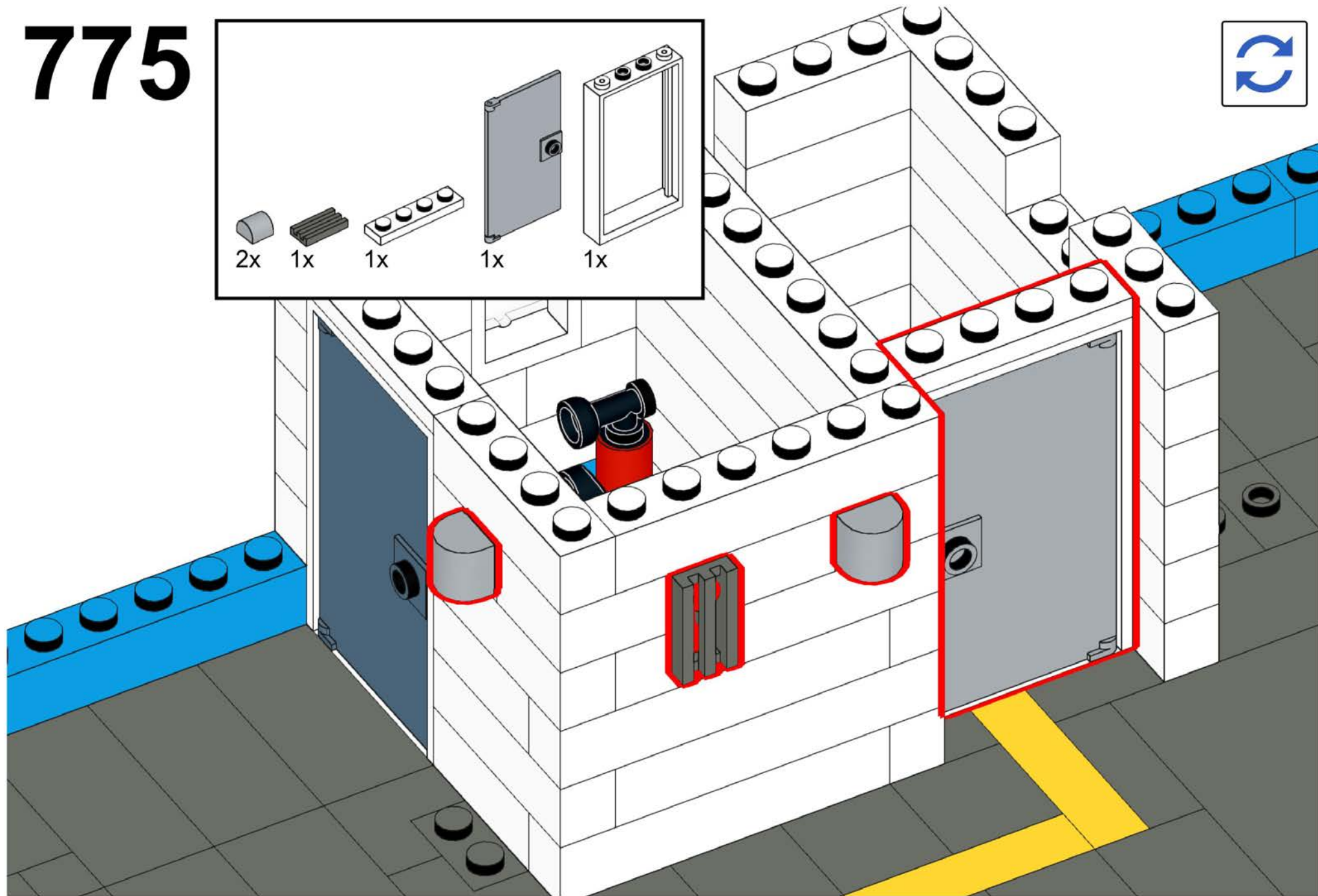
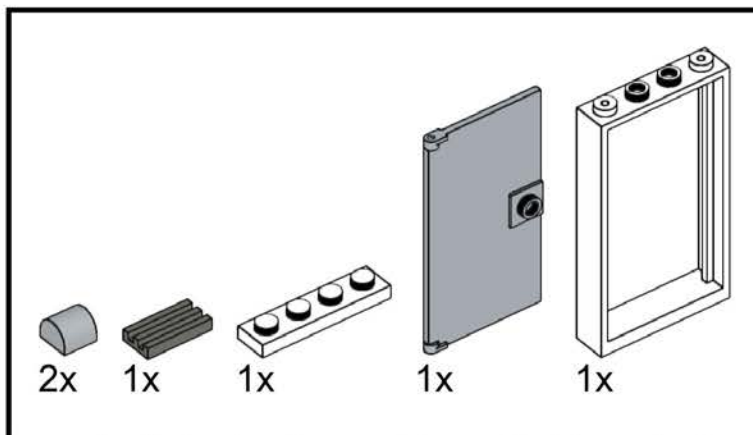

# 776

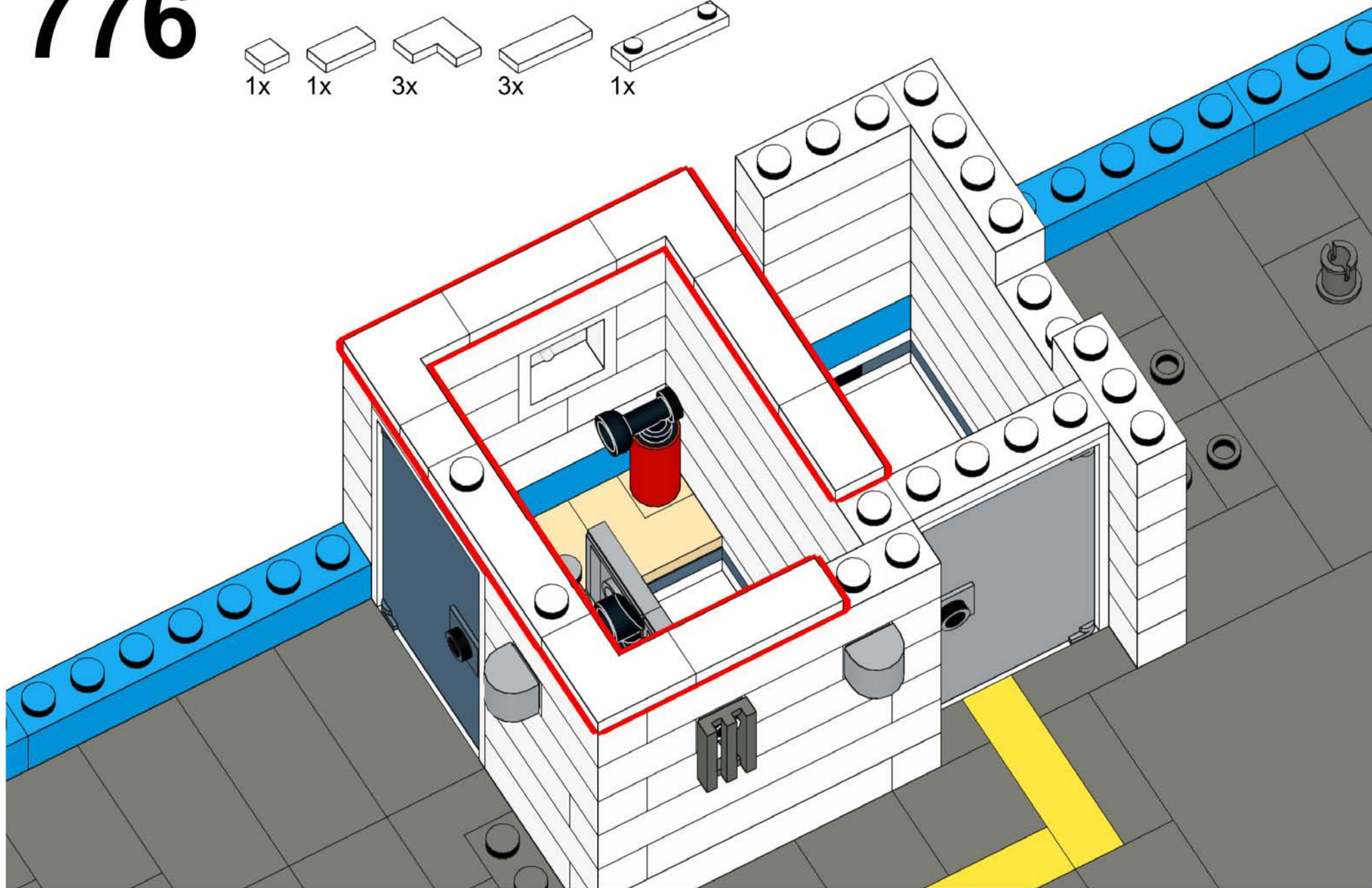
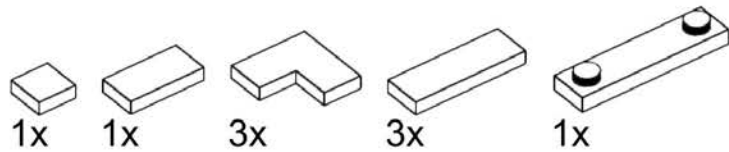

# 777

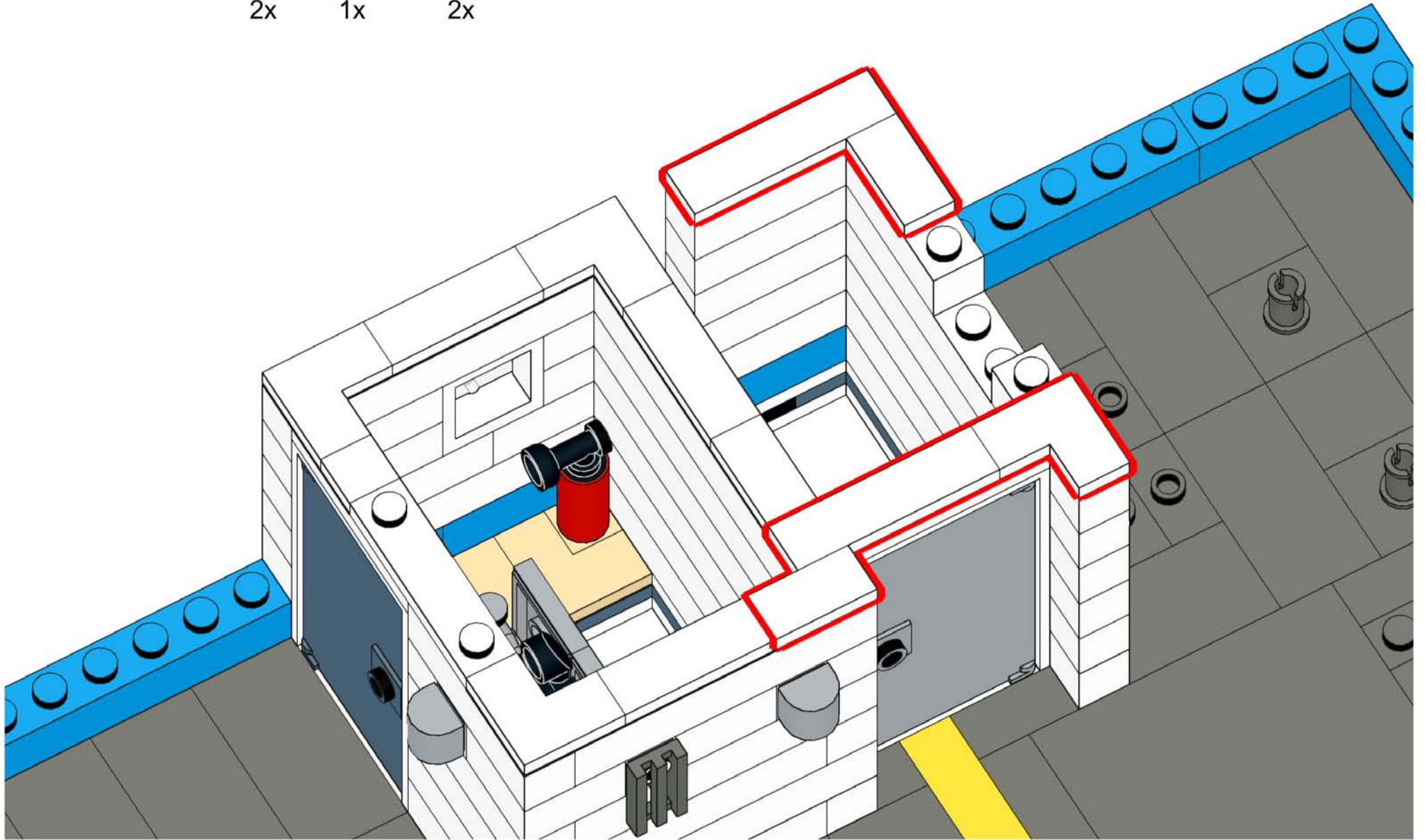
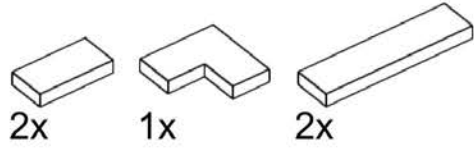

# 778

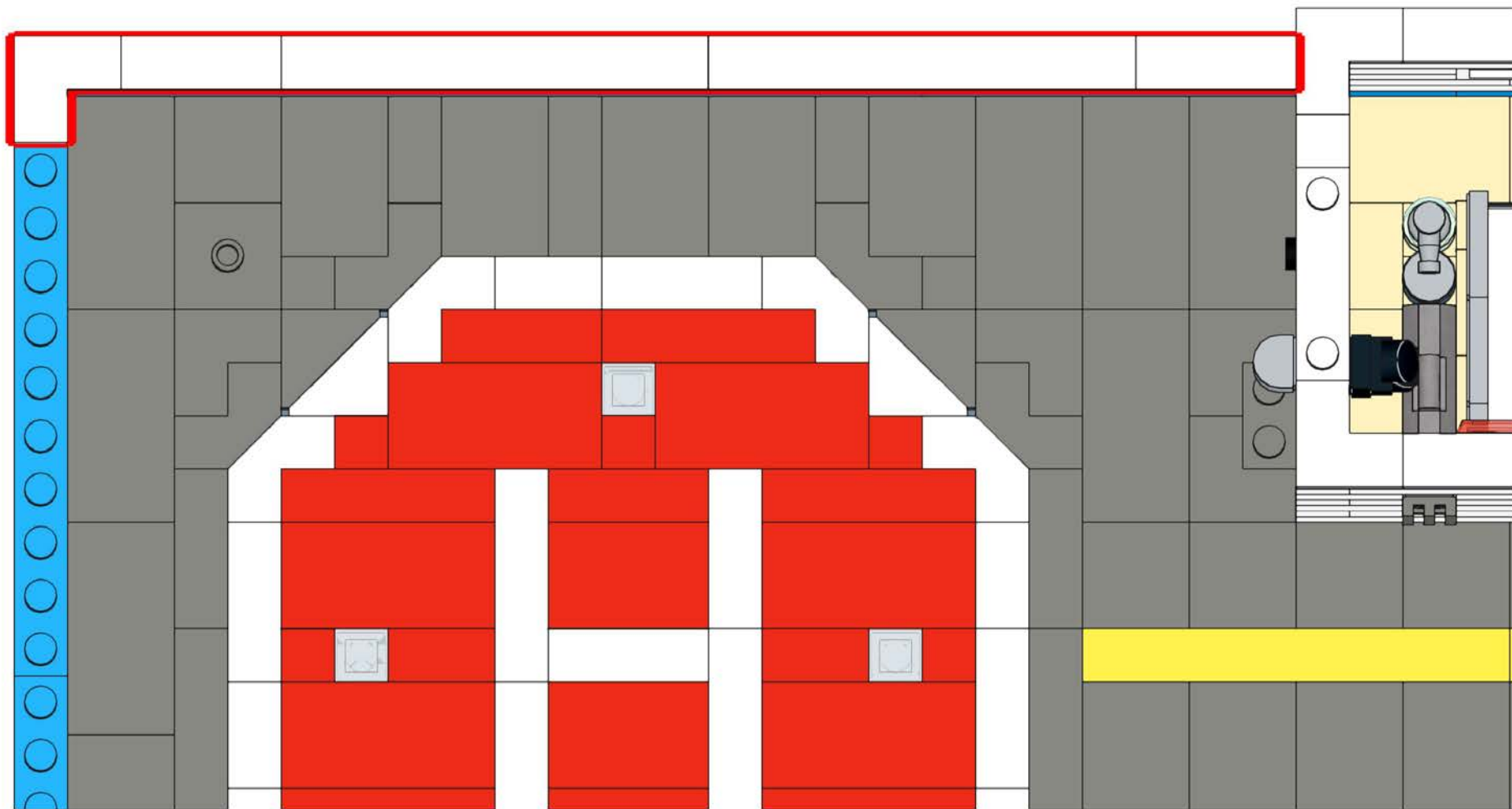
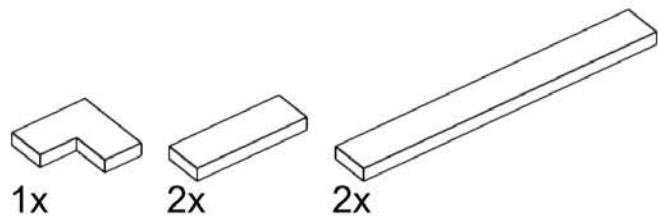

# 779

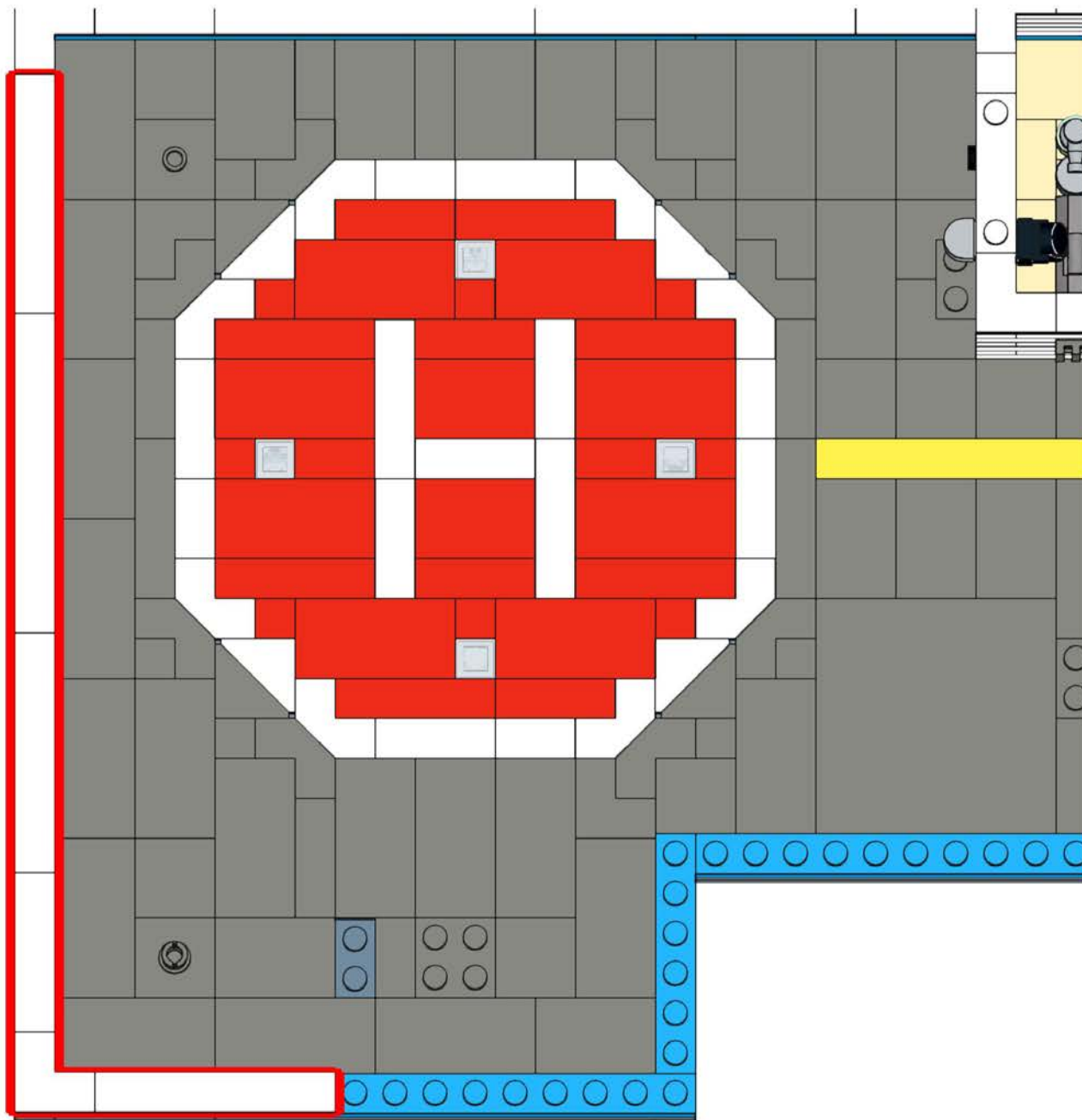
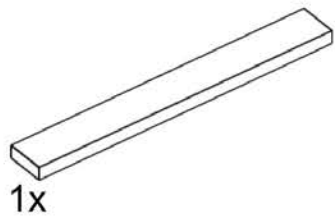
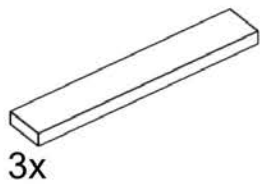
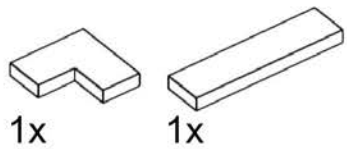

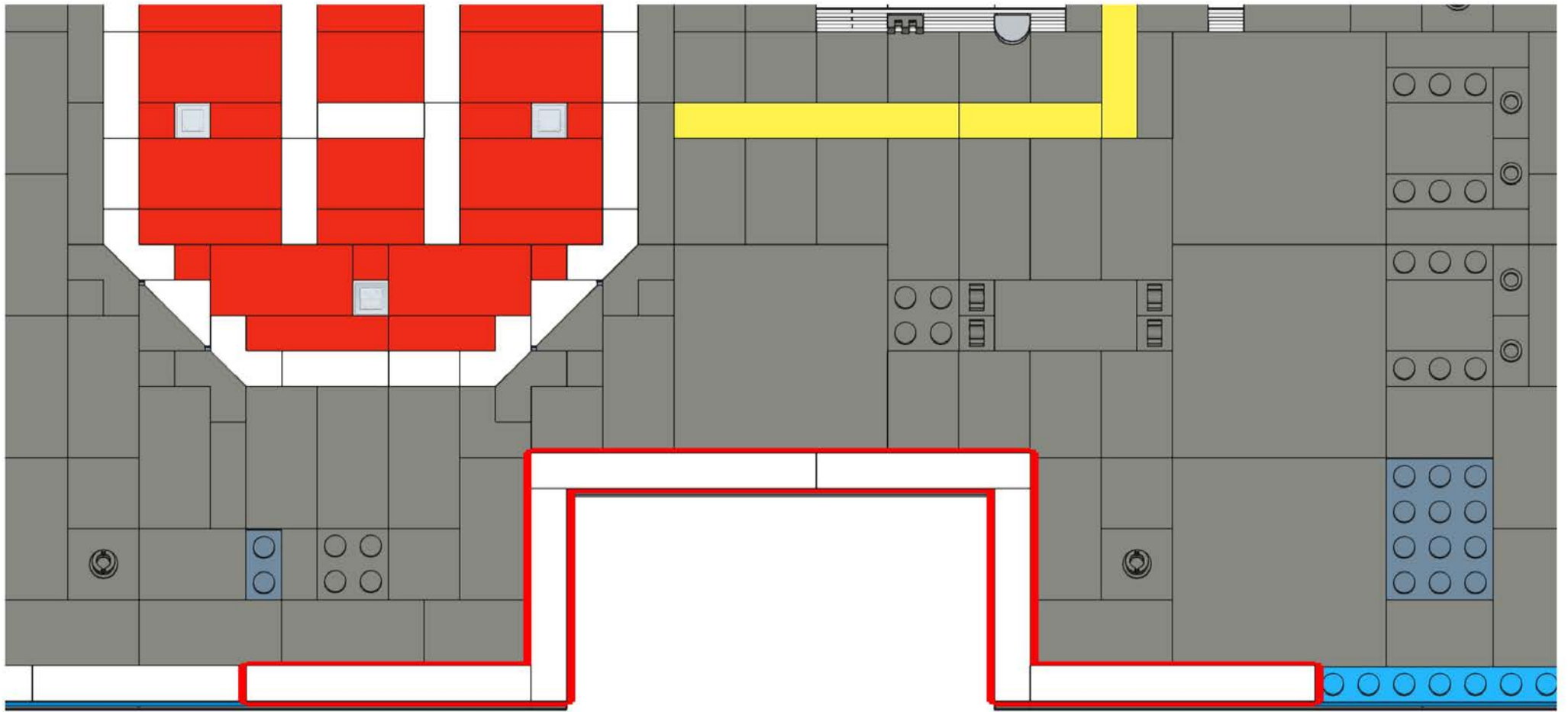

**780**

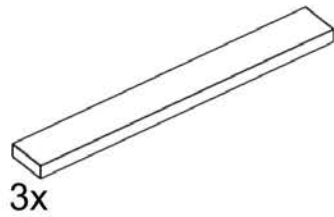
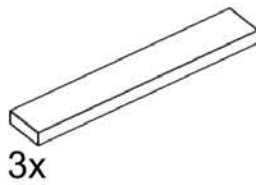



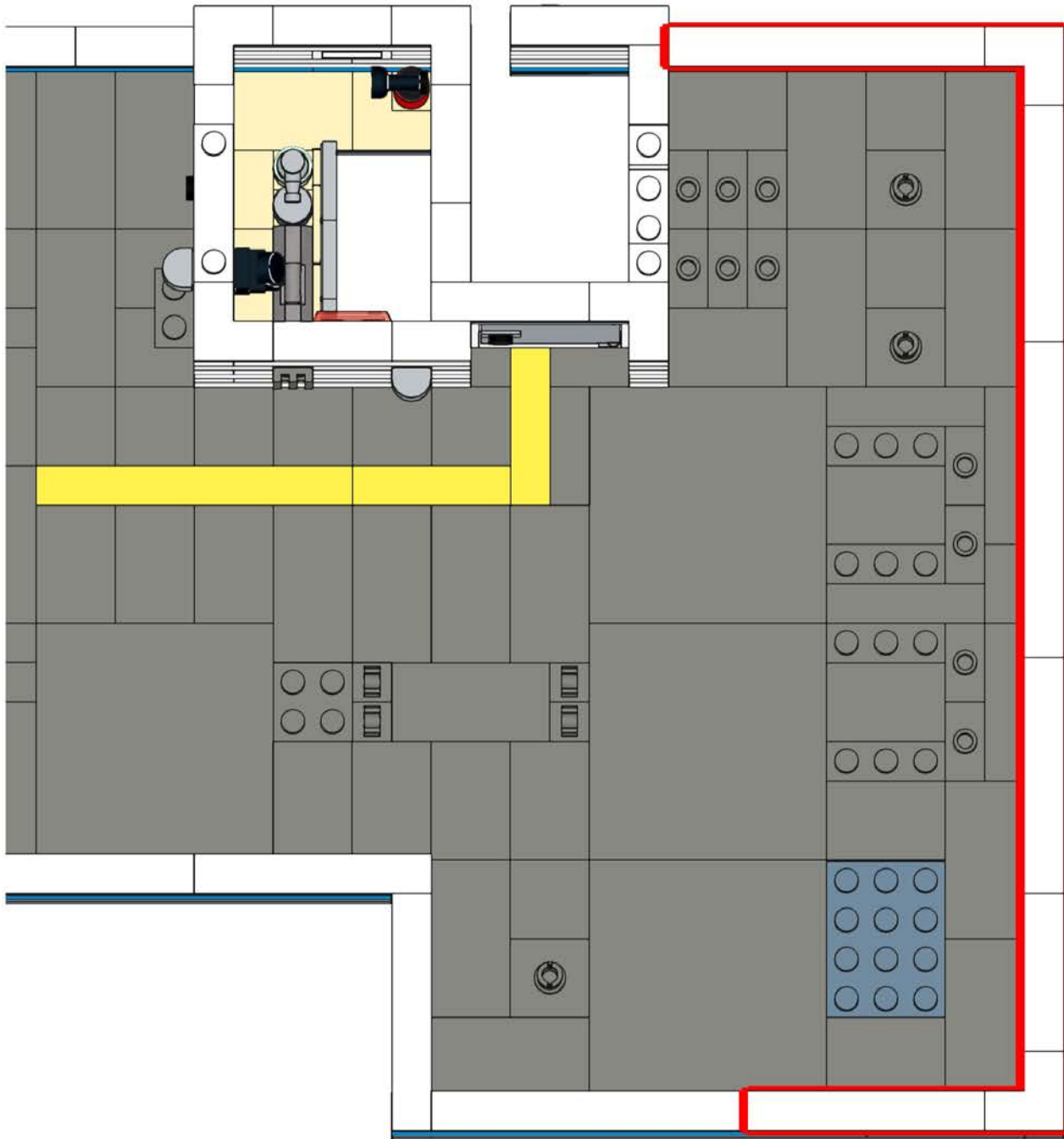

# 781

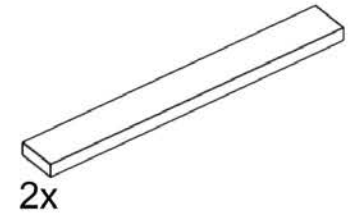
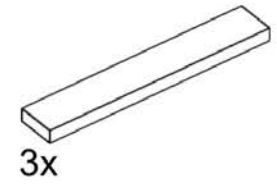
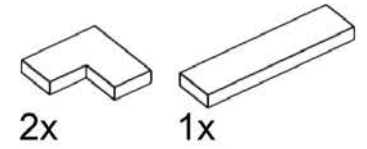

# 782

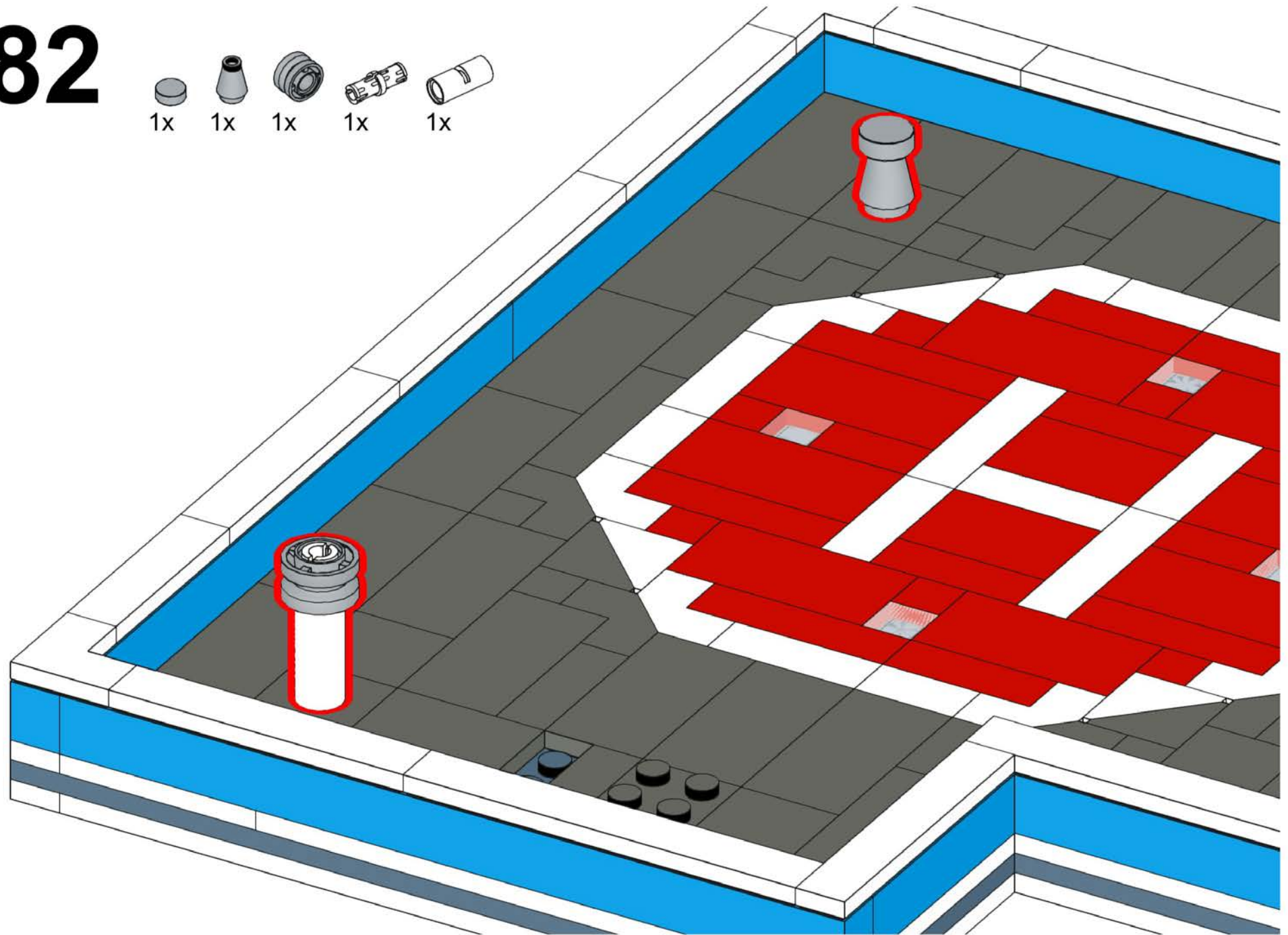

# 783

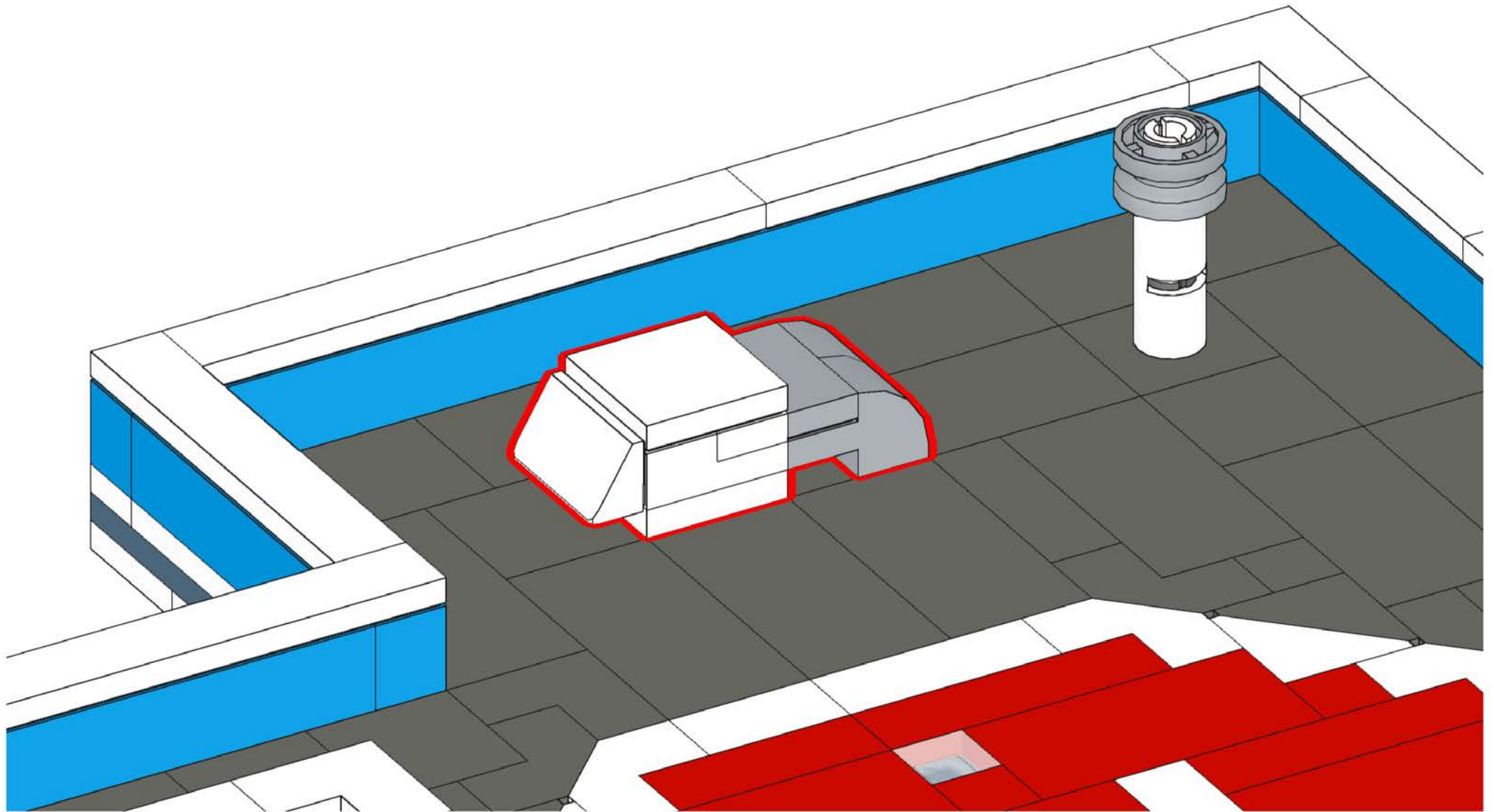
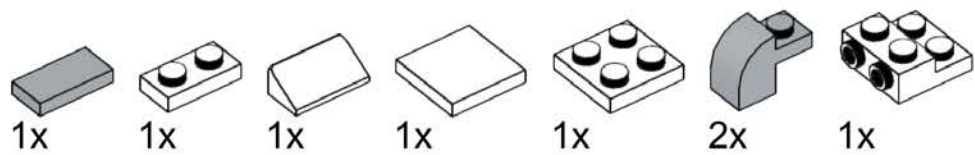

# 784



1x

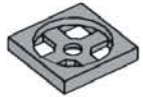

1x

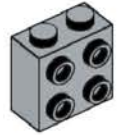

1x

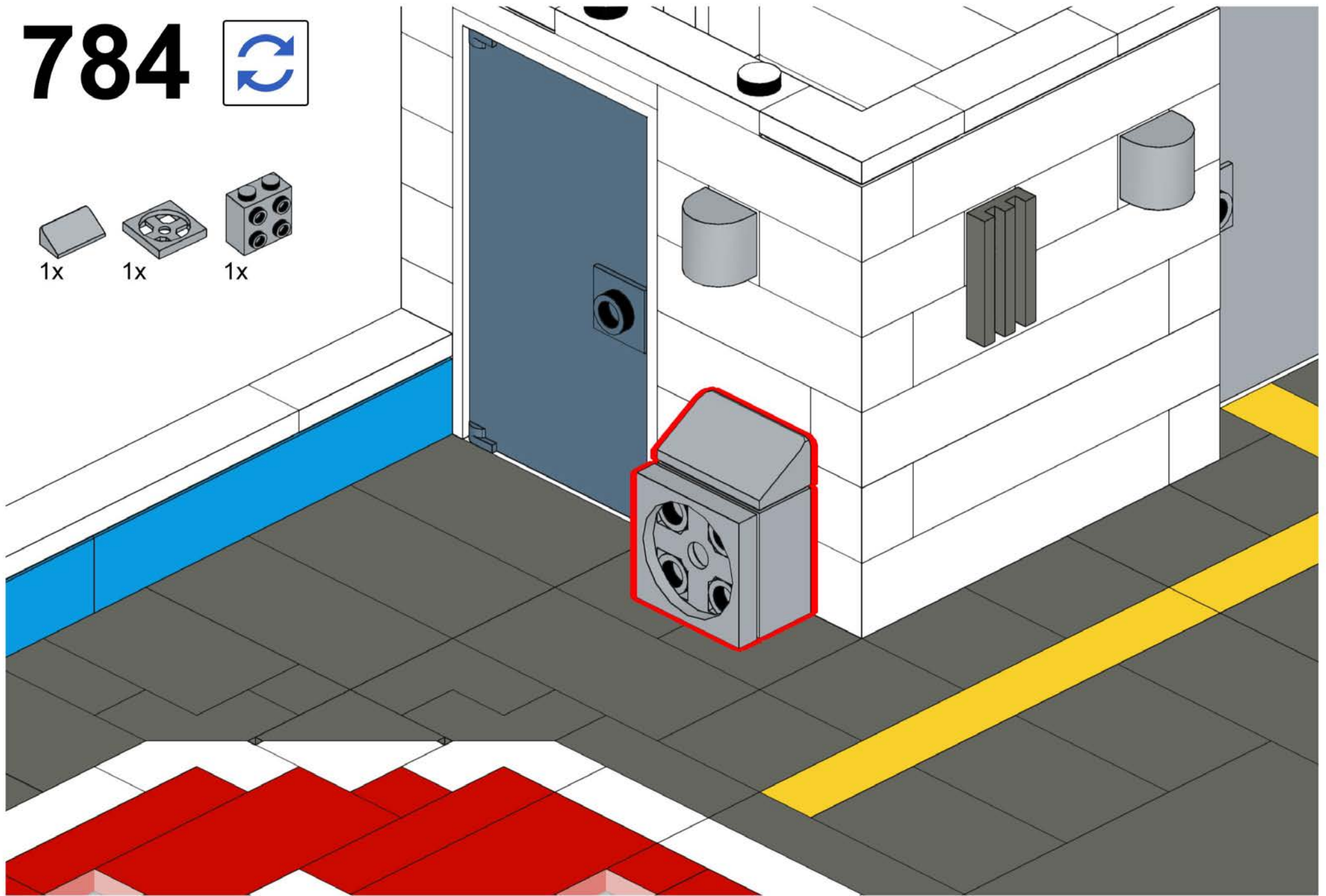

# 785

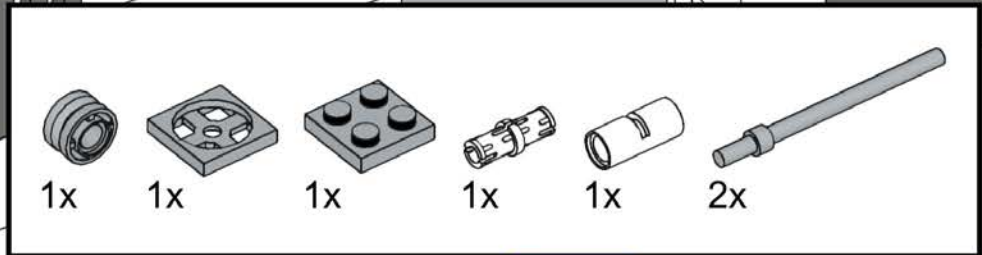

1x 1x 1x 1x 1x 2x

This block contains a list of six parts with their respective quantities: a grey bush (1x), a grey 4-way connector (1x), a grey 1x3 plate (1x), a grey axle (1x), a grey sleeve (1x), and a grey axle pin (2x).

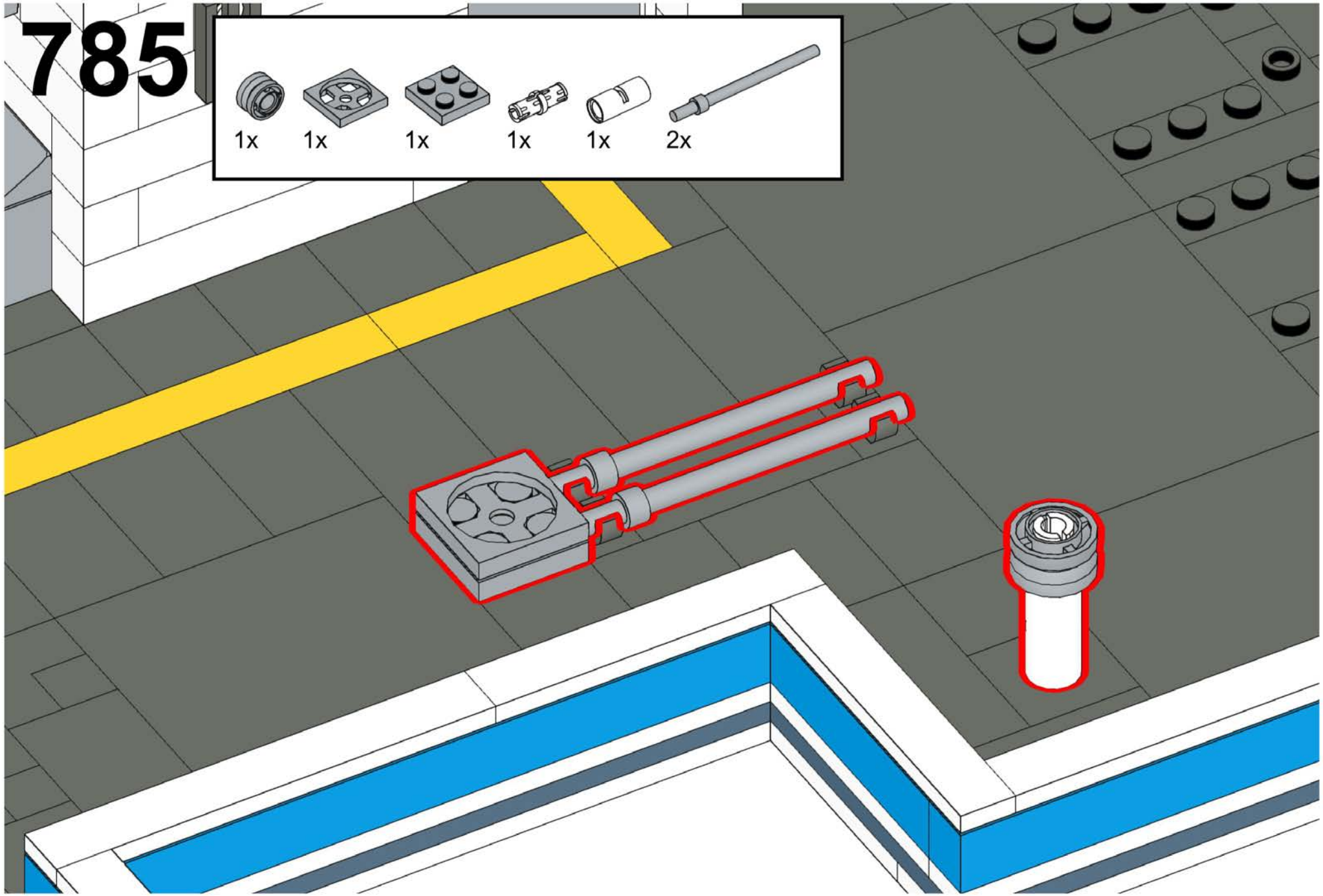

# 786

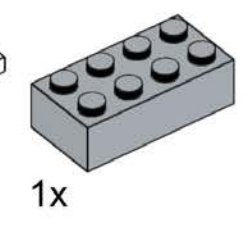
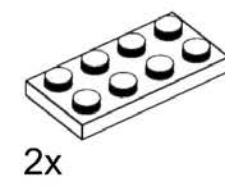
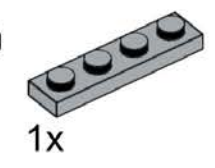
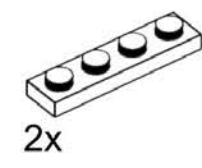
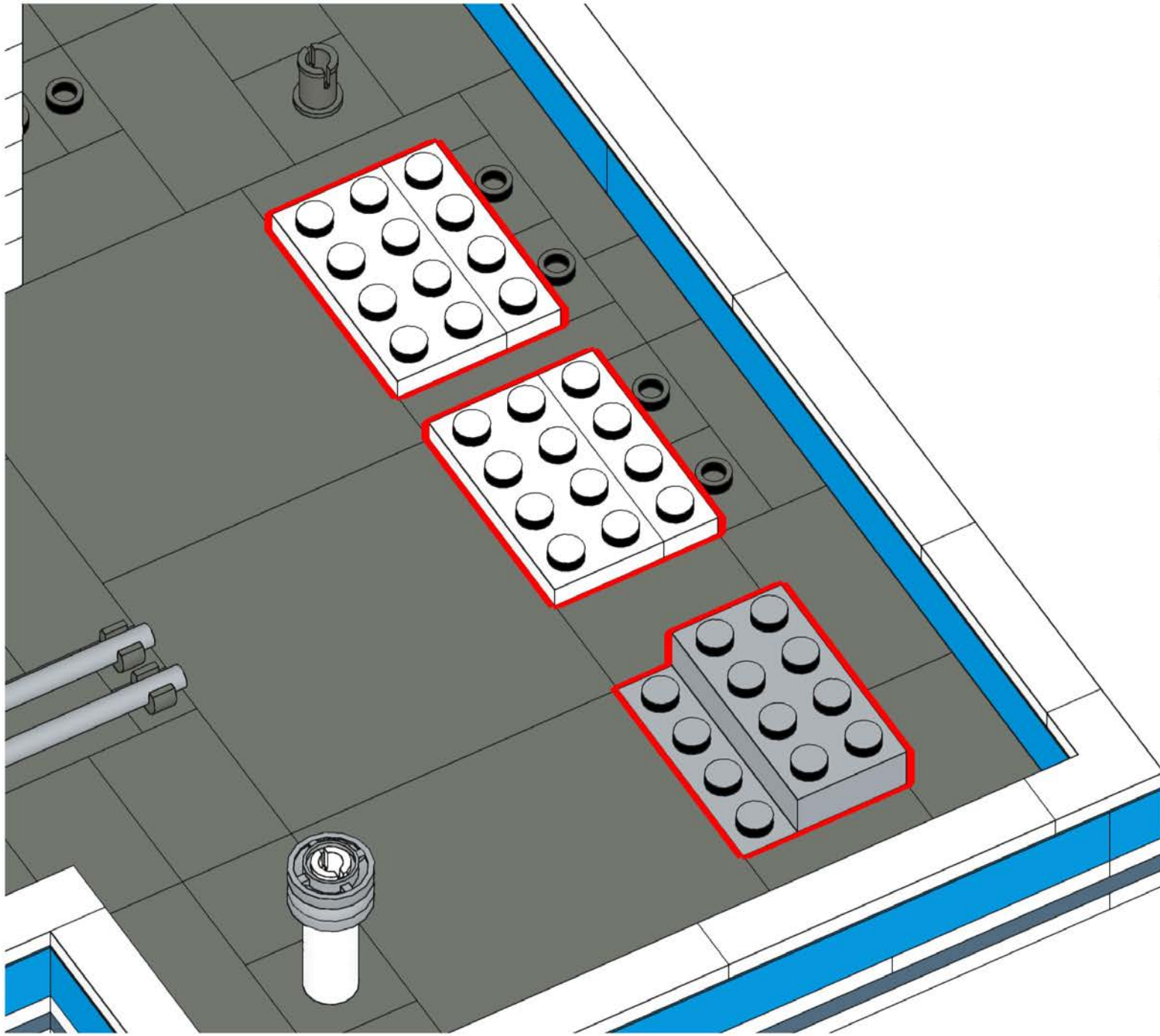

# 787

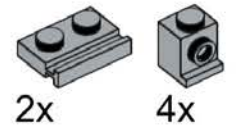
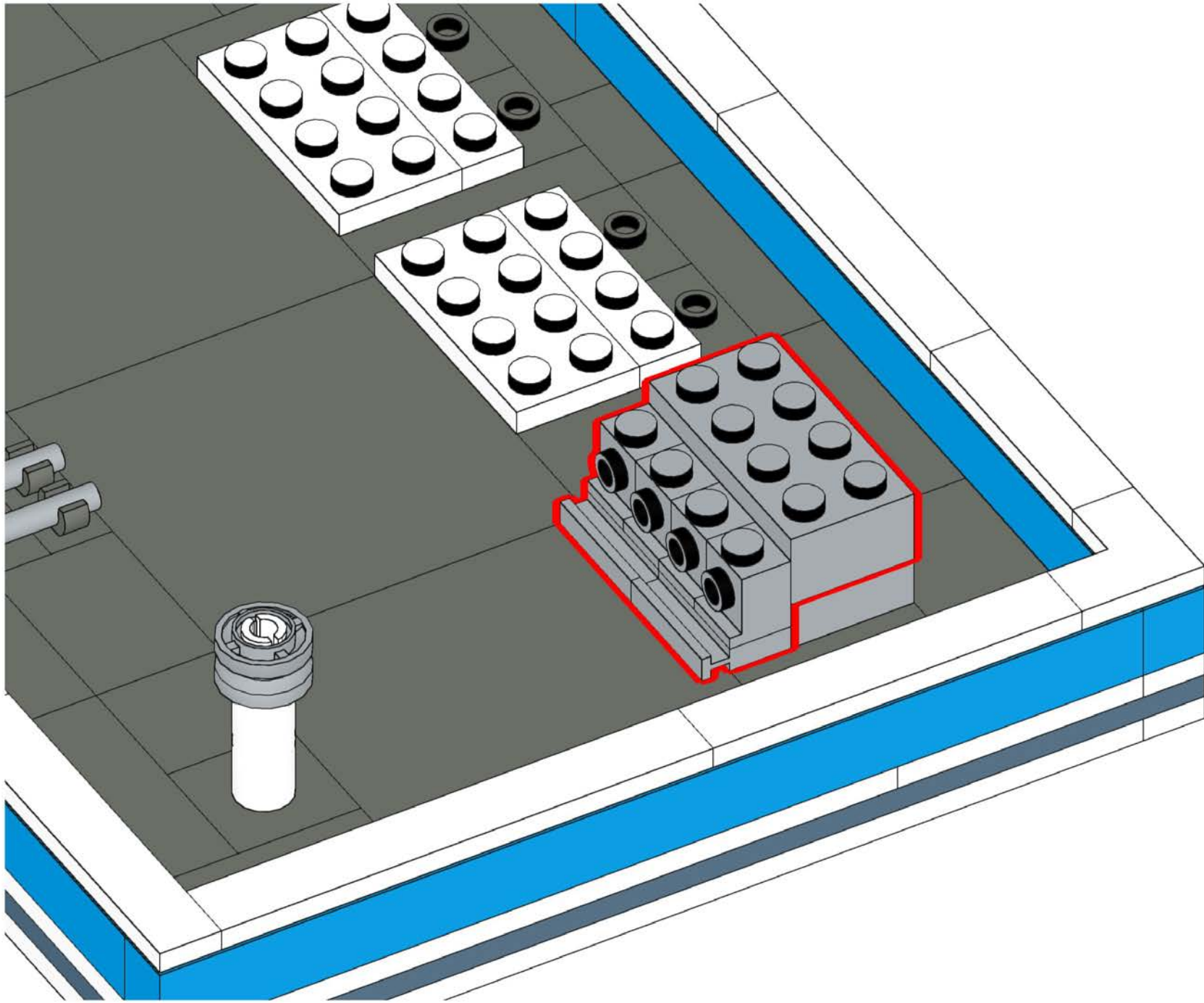

2x

4x

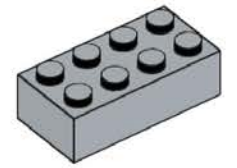

1x

# 788

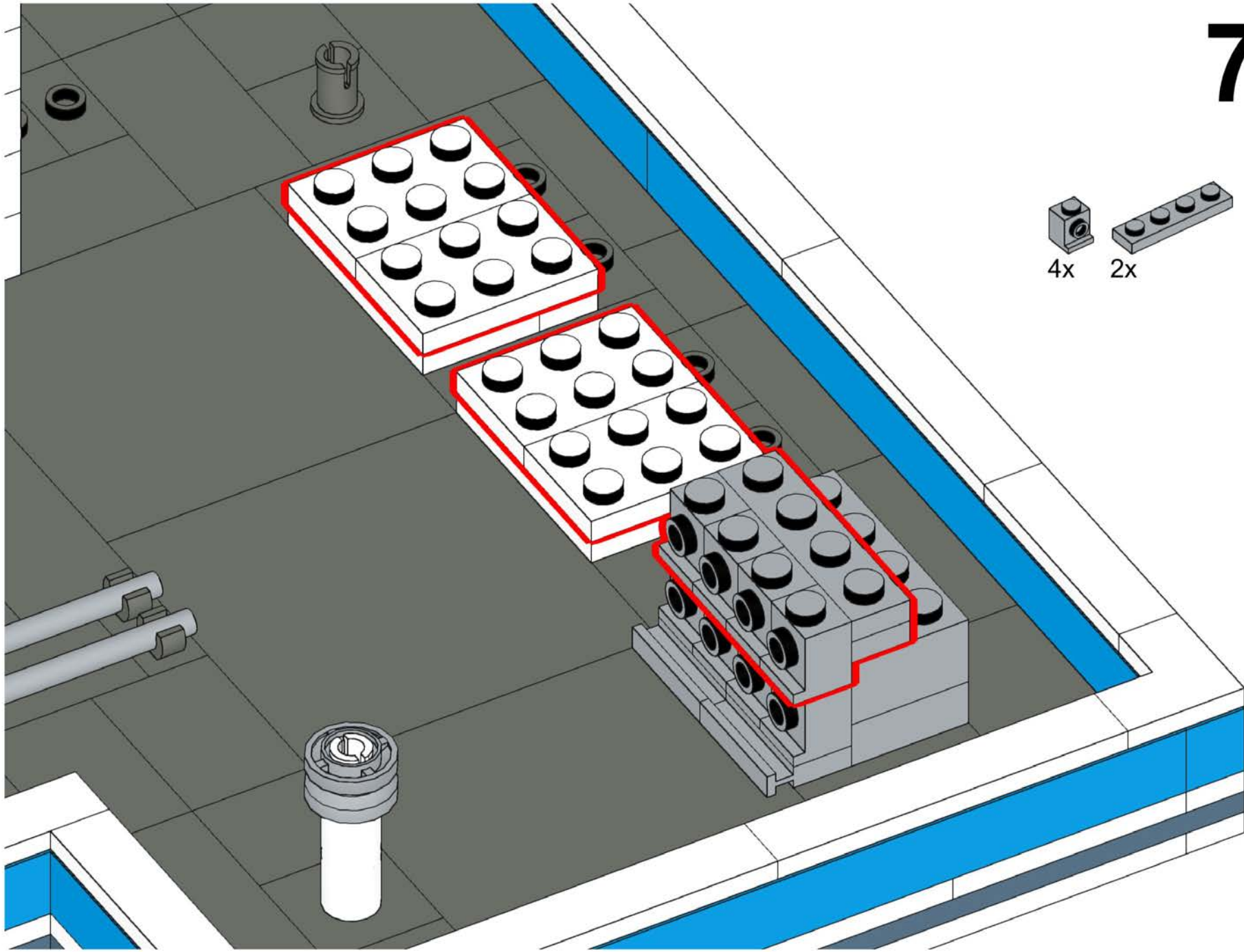

- 4x
- 2x
- 4x



# 789

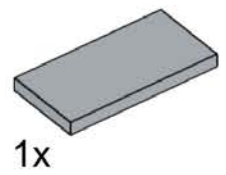
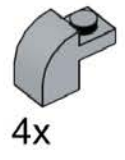
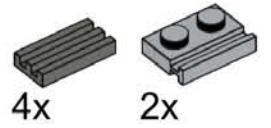
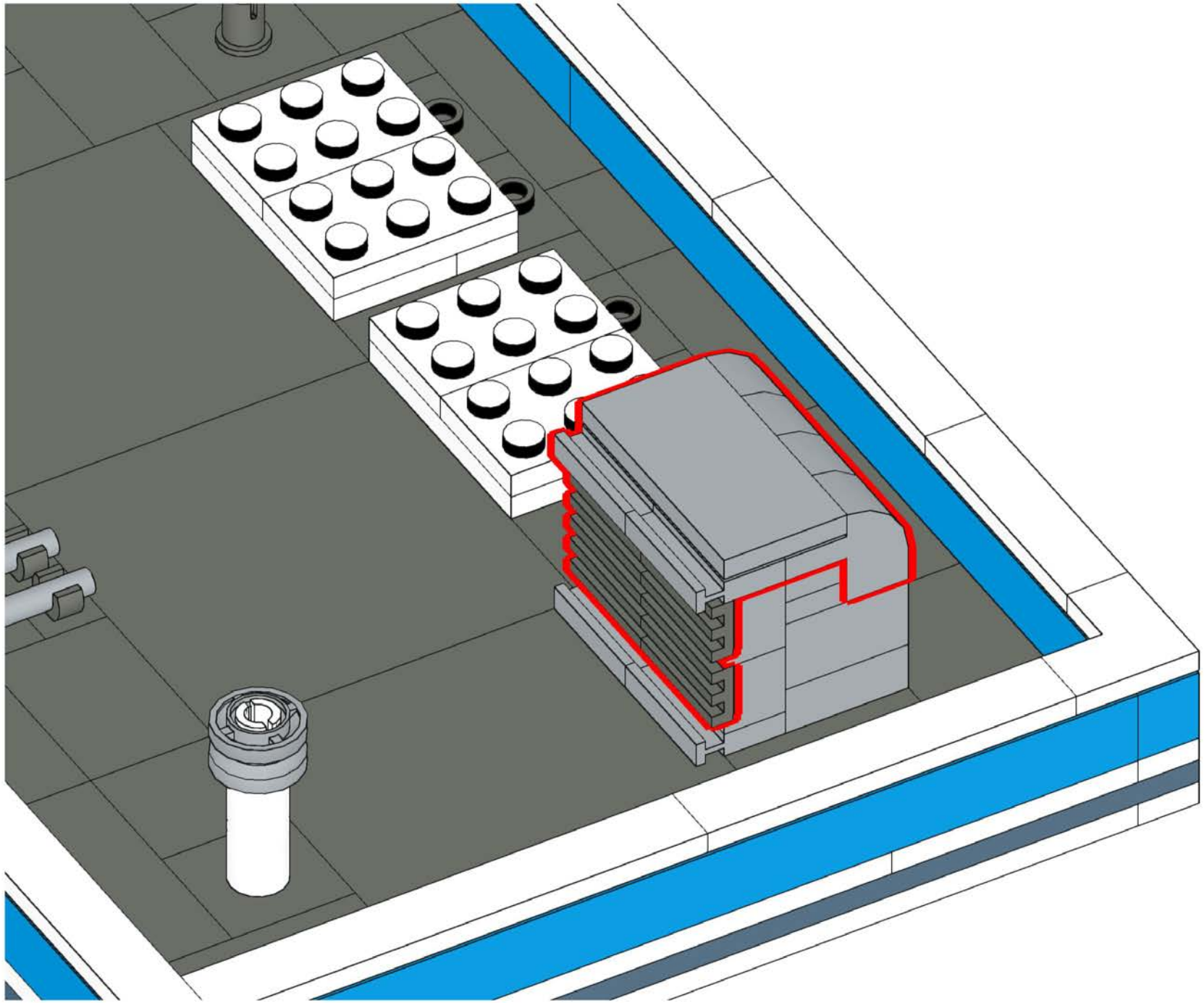

# 790

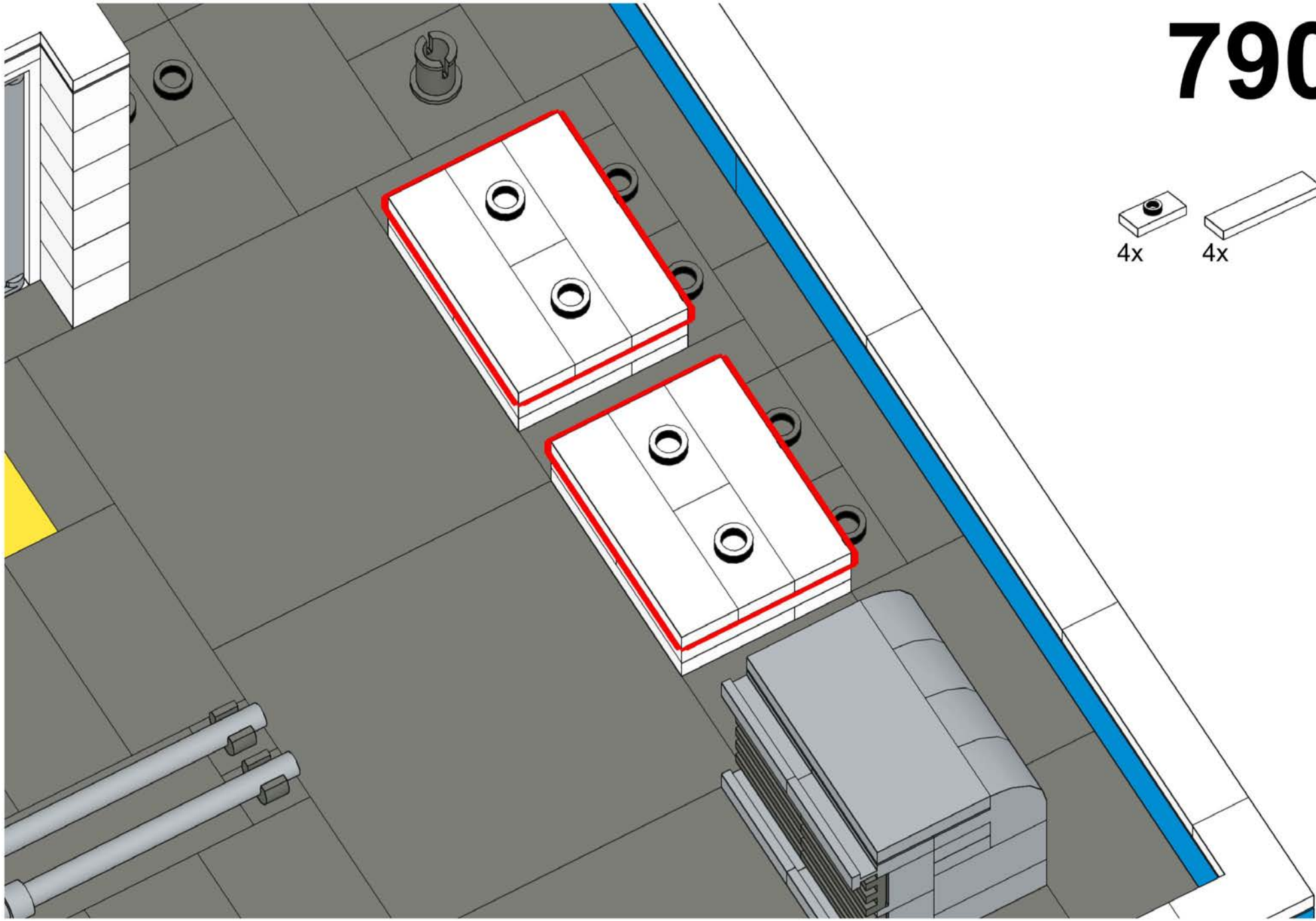

# 791

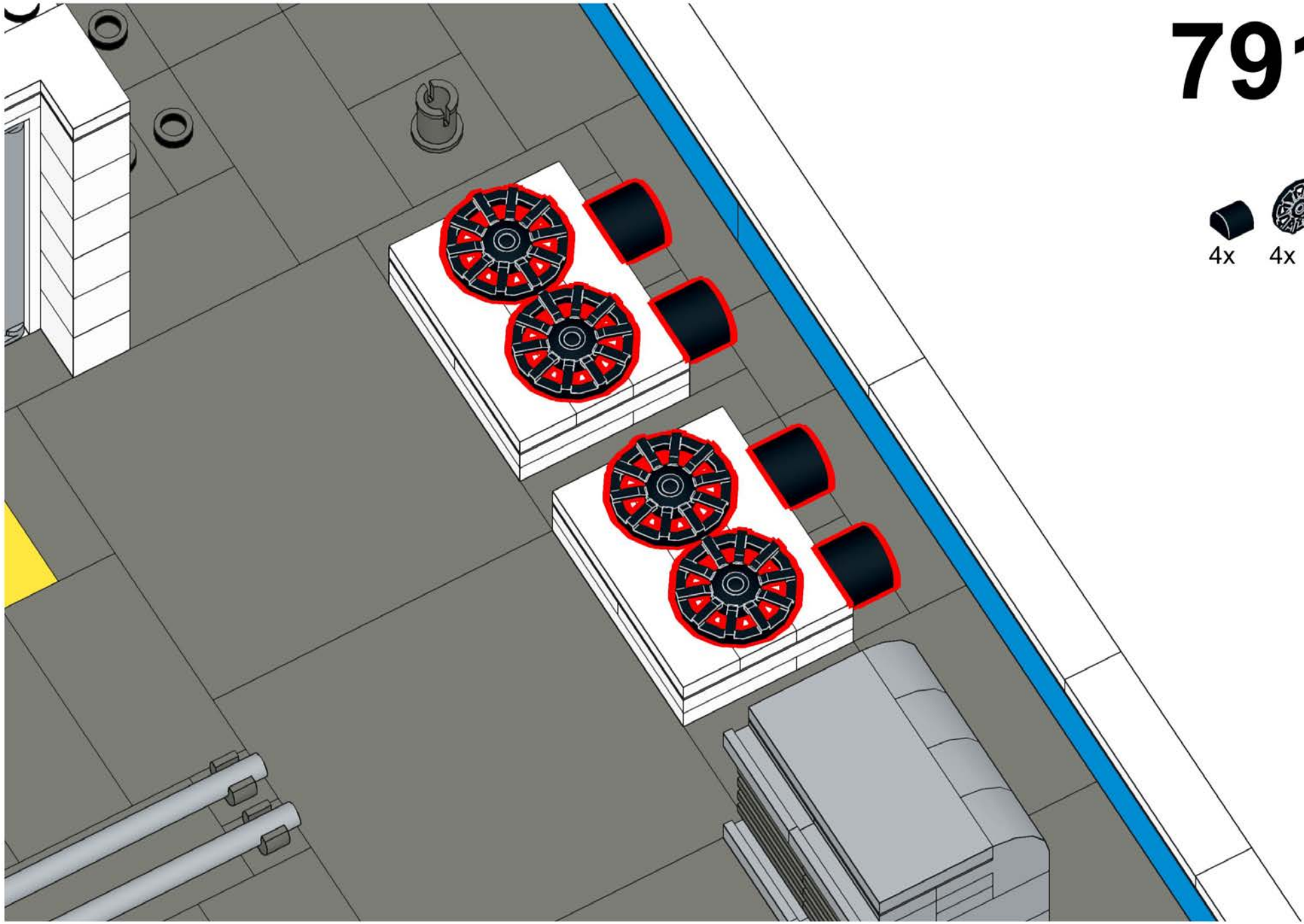
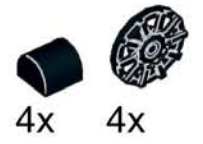

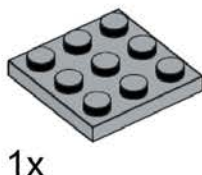
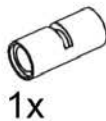
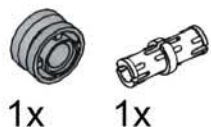
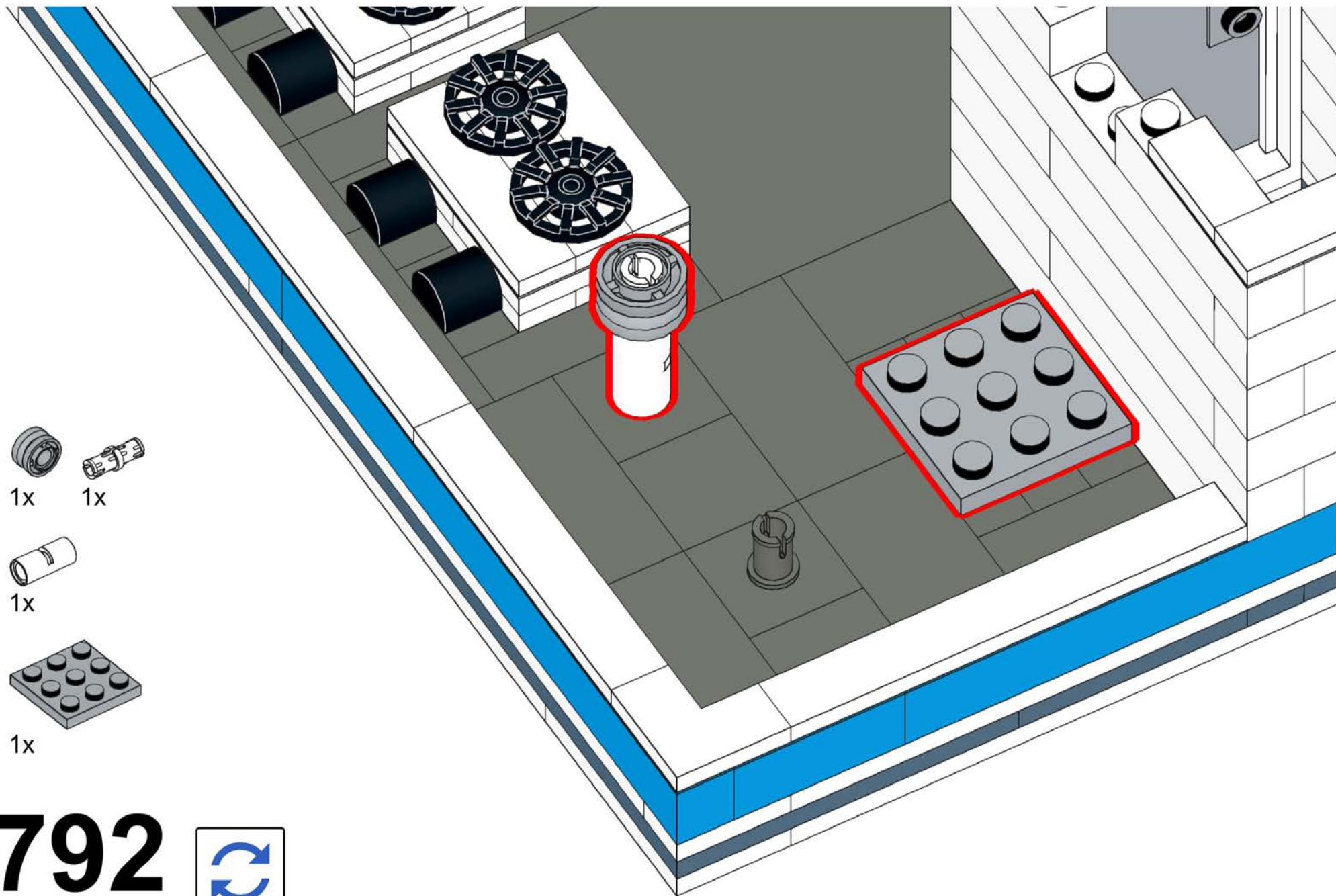

**792**



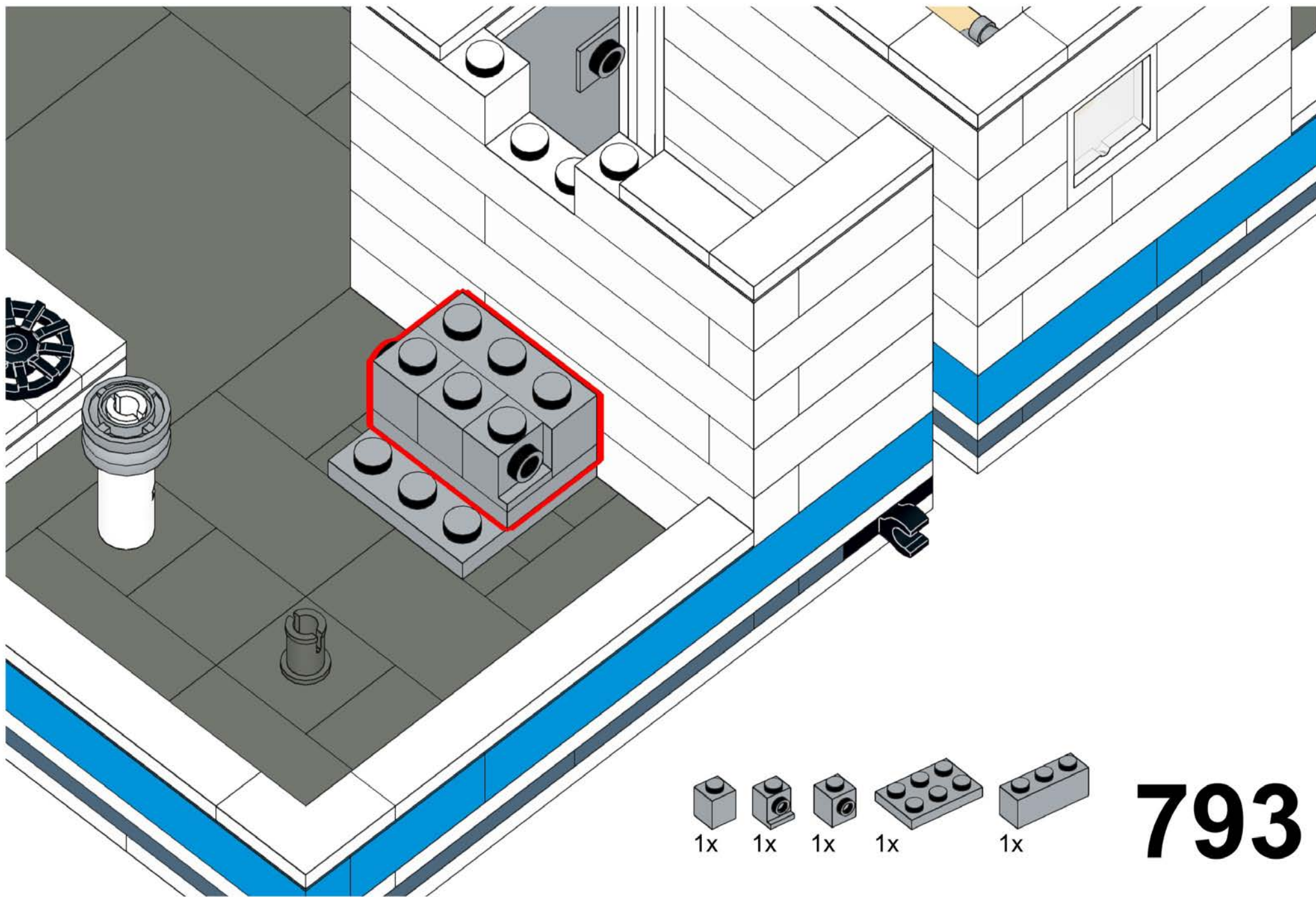

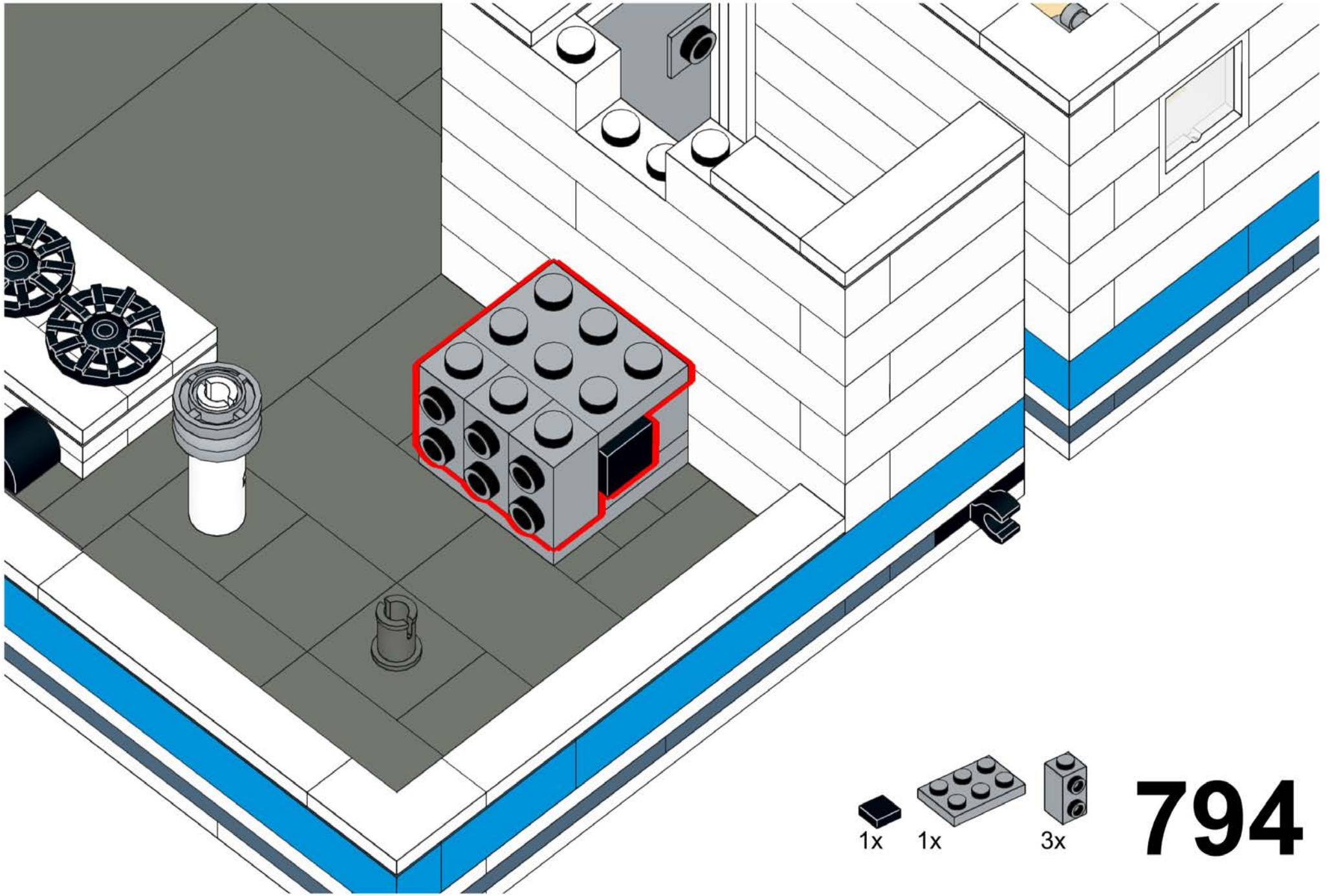

1x

1x

3x

794

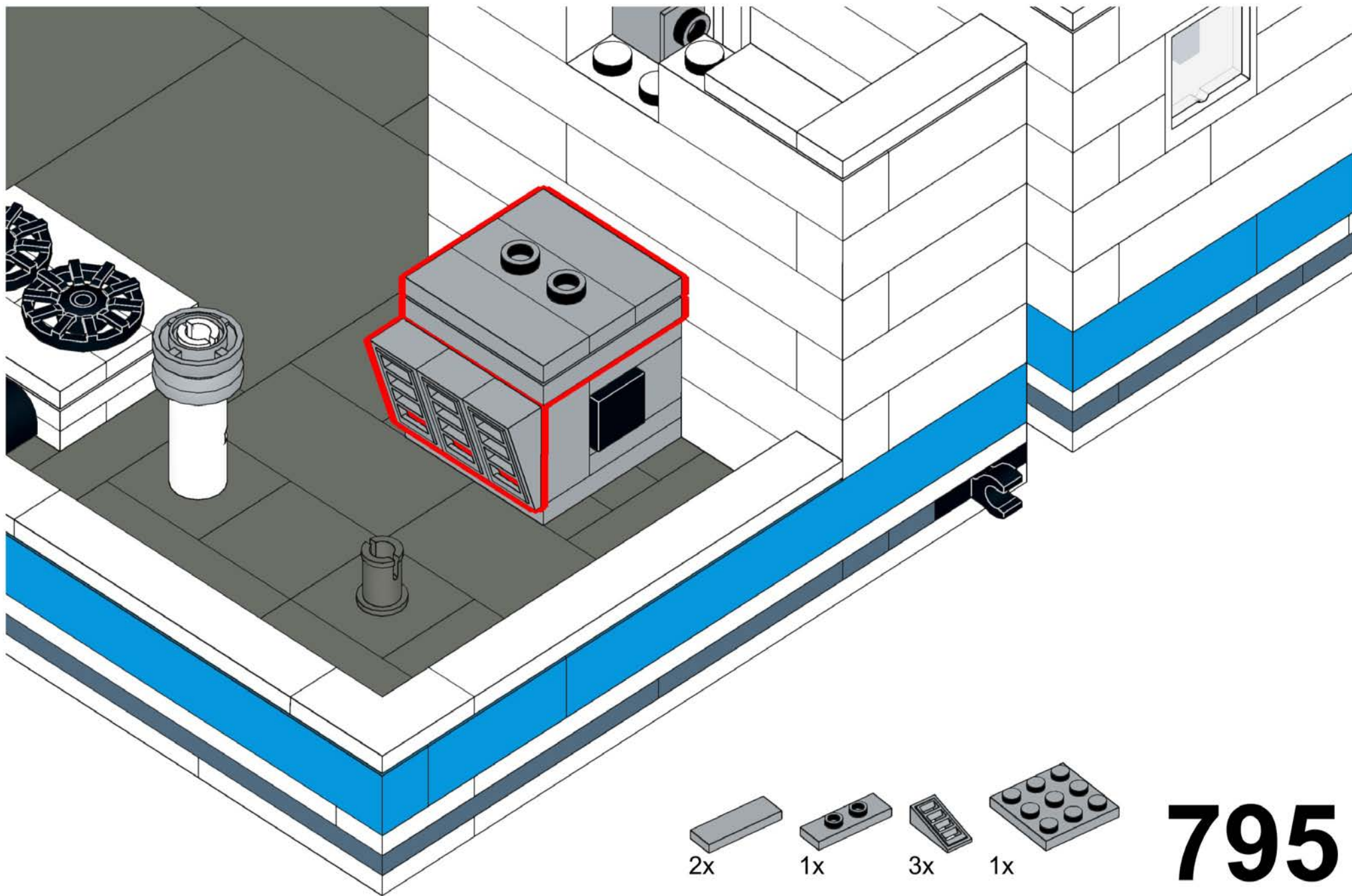

2x

1x



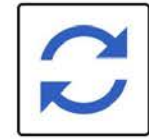

3x

1x

795



# 796



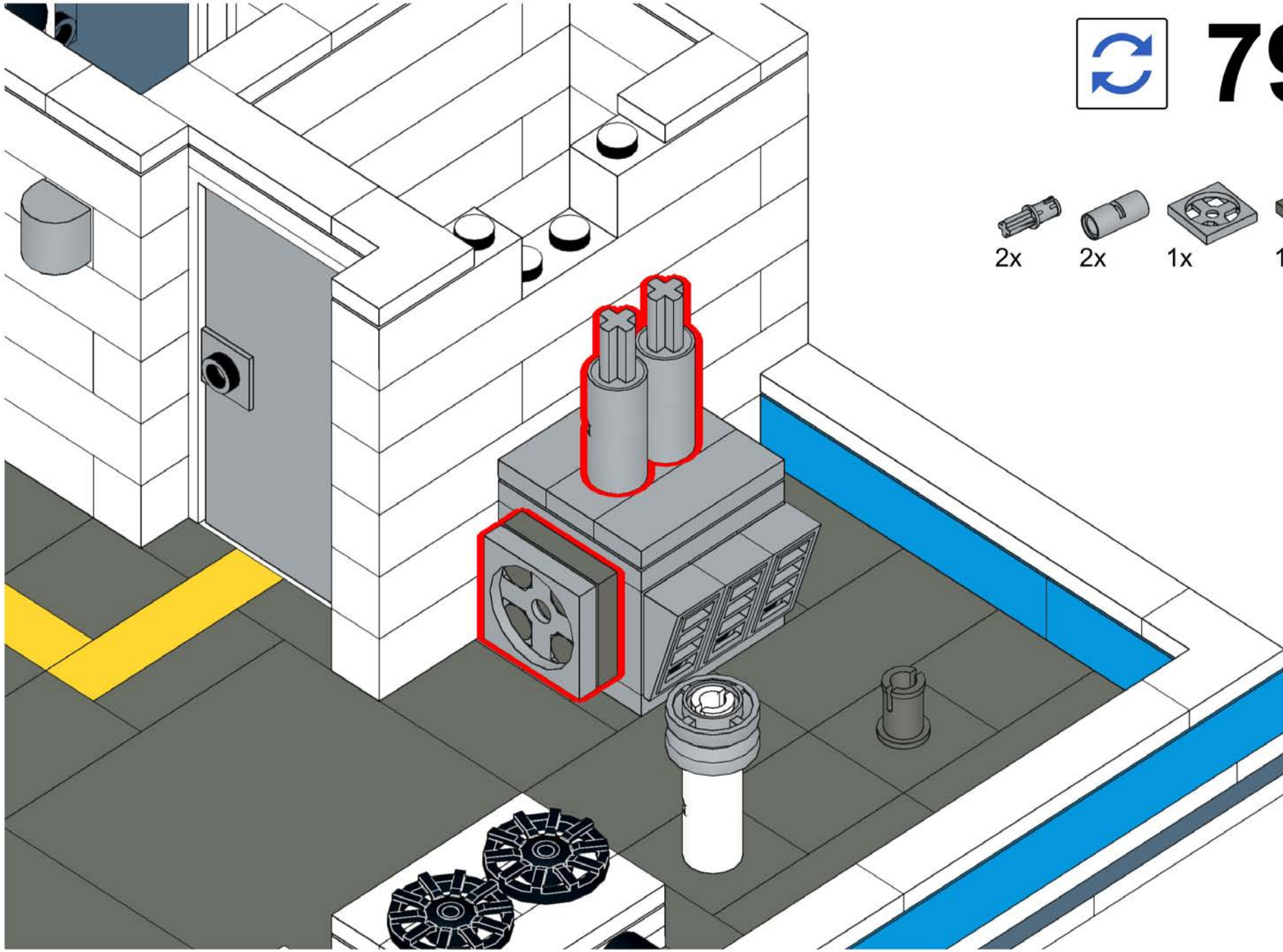

- 2x 
- 2x 
- 1x 
- 1x 



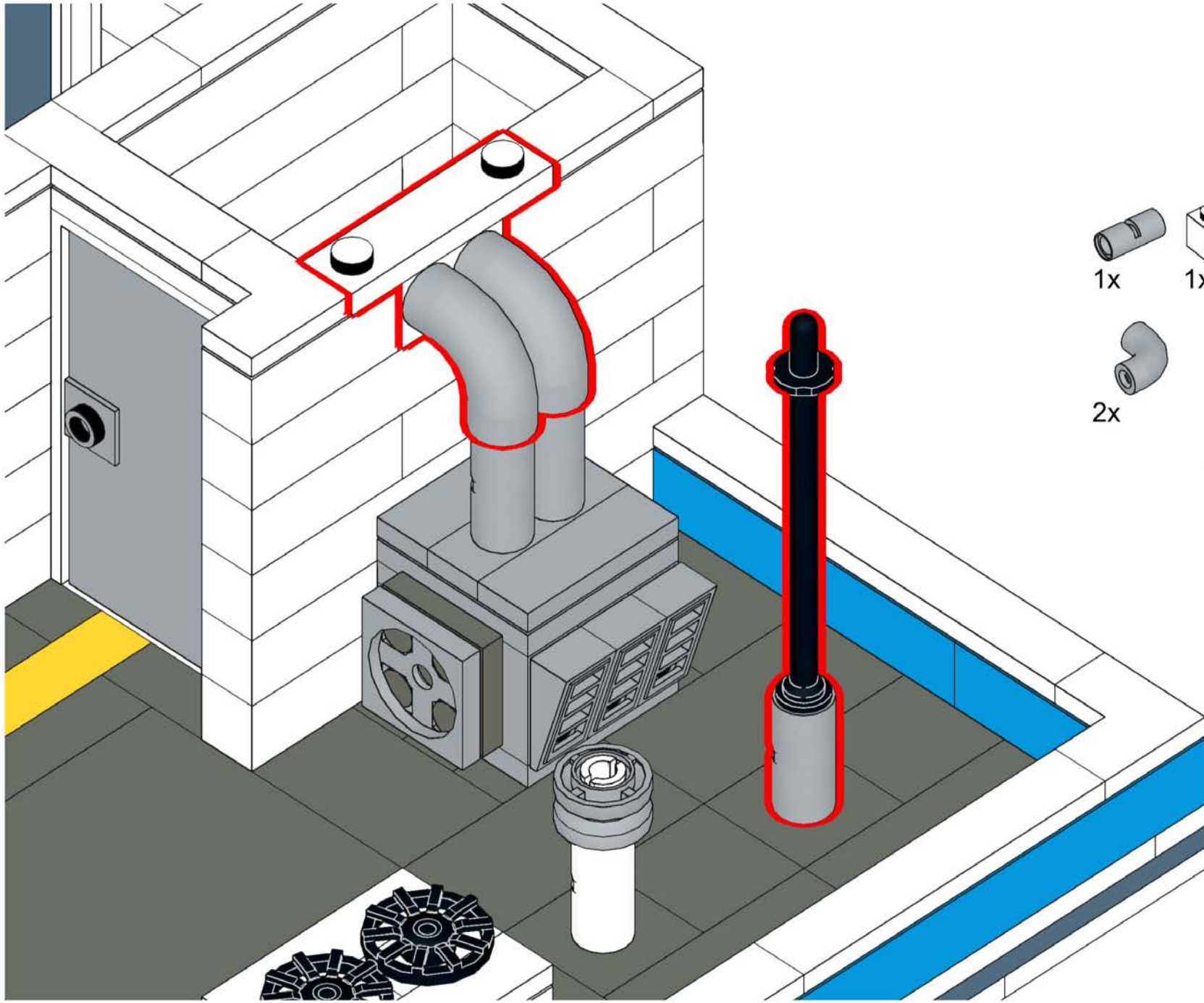

# 797

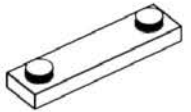

- 1x 
- 1x 
- 1x 
- 2x 
- 1x 

# 798

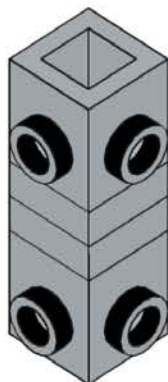
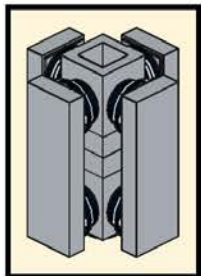
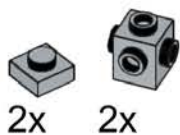

# 799



# 800

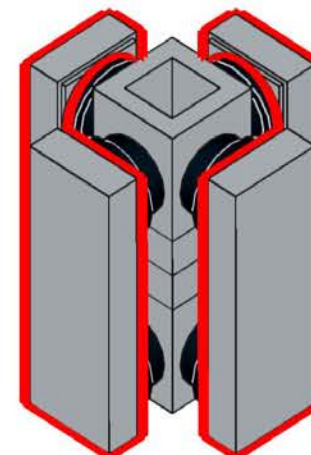
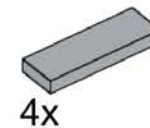

801

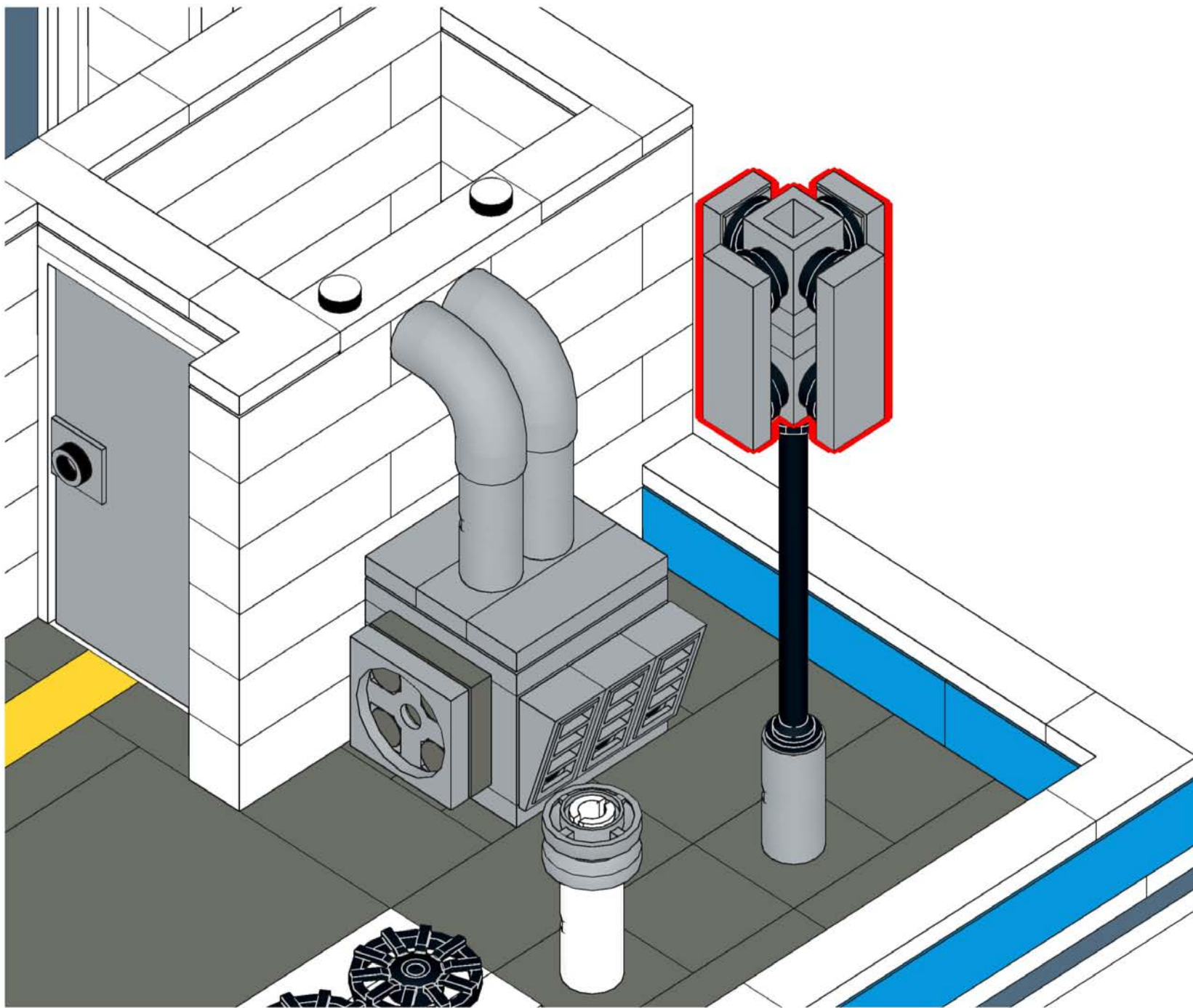

# 802

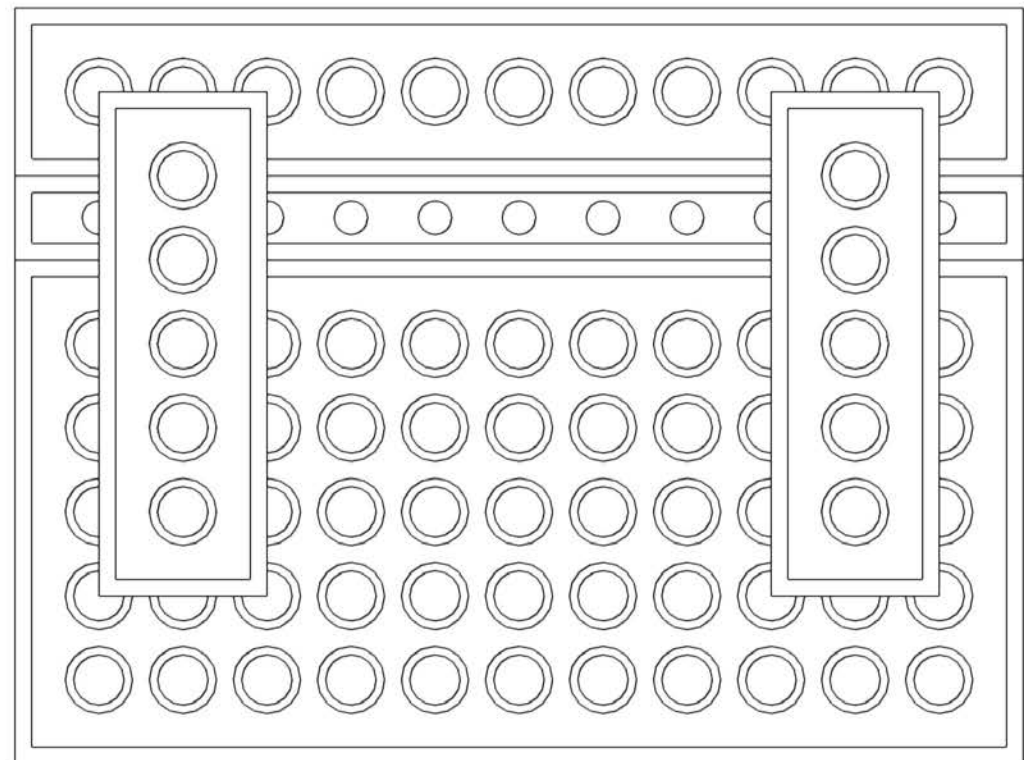
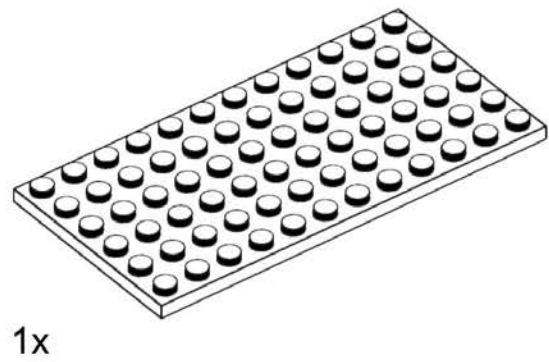
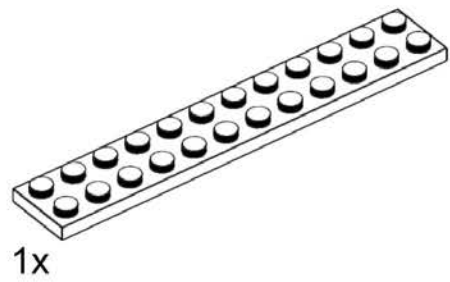
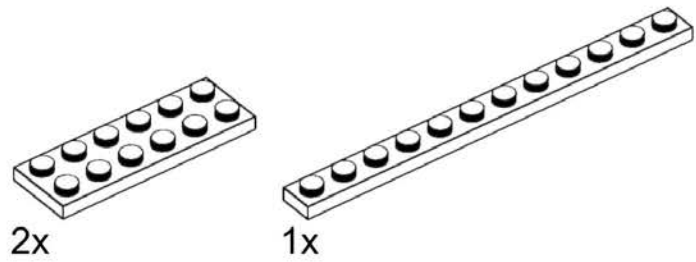
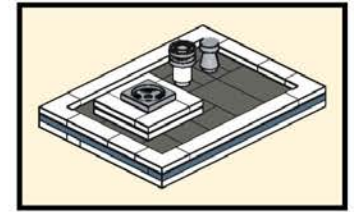

# 803

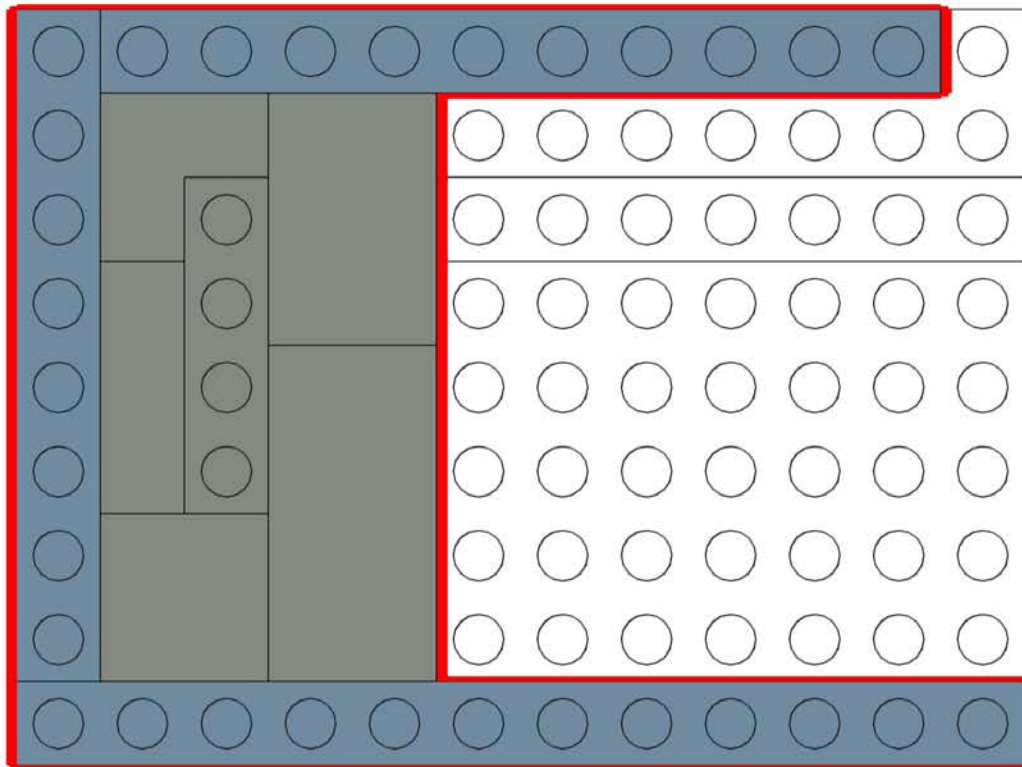
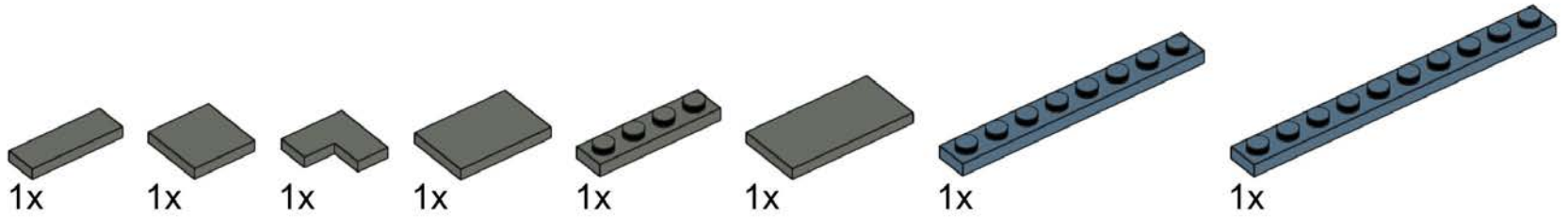

# 804

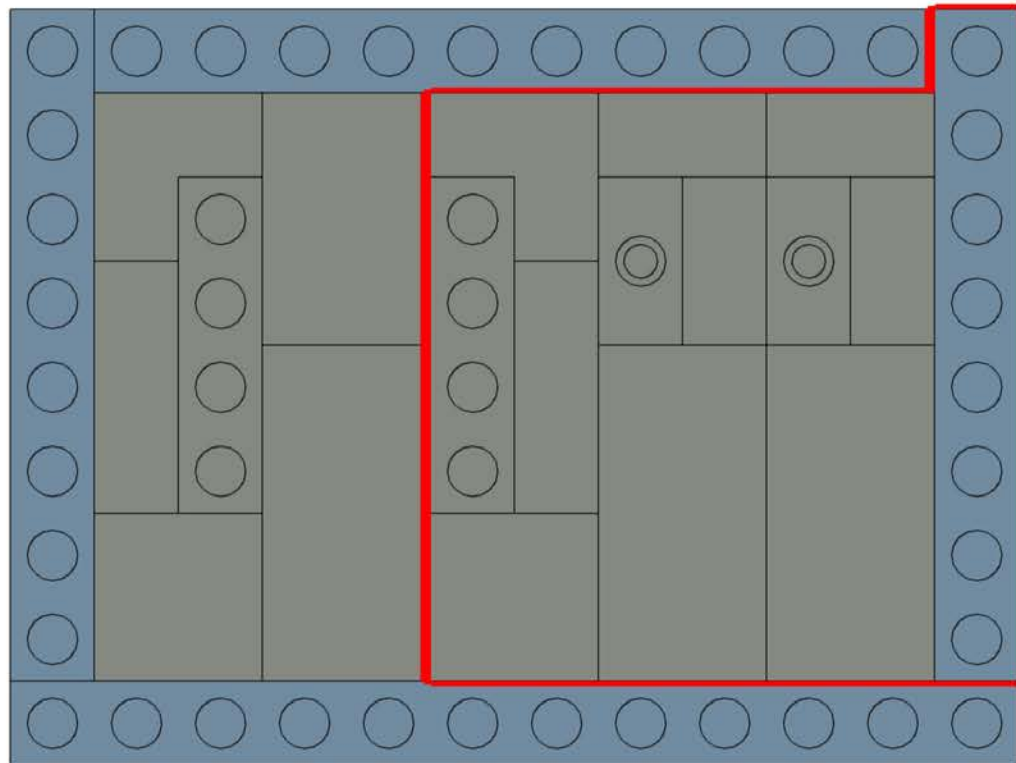
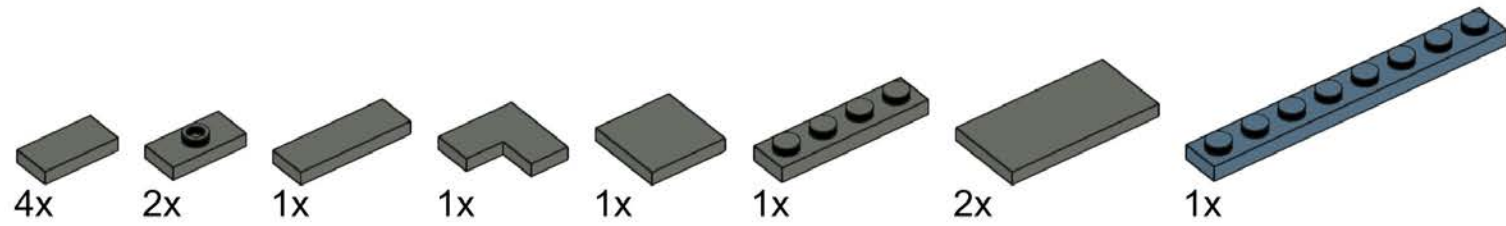

# 805

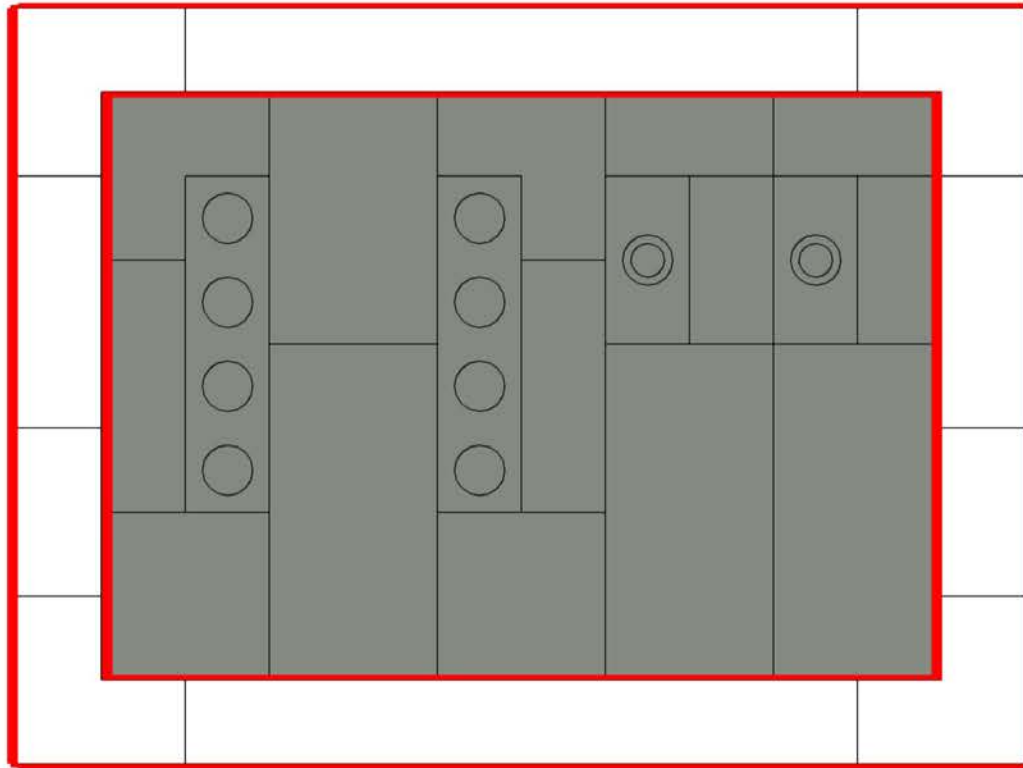
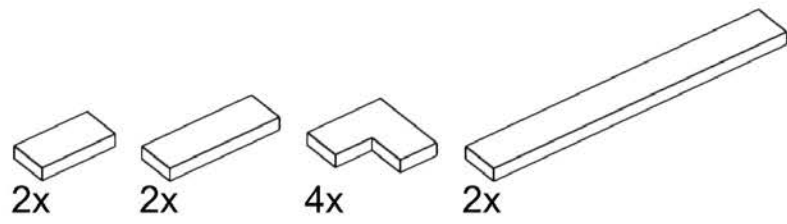

# 806

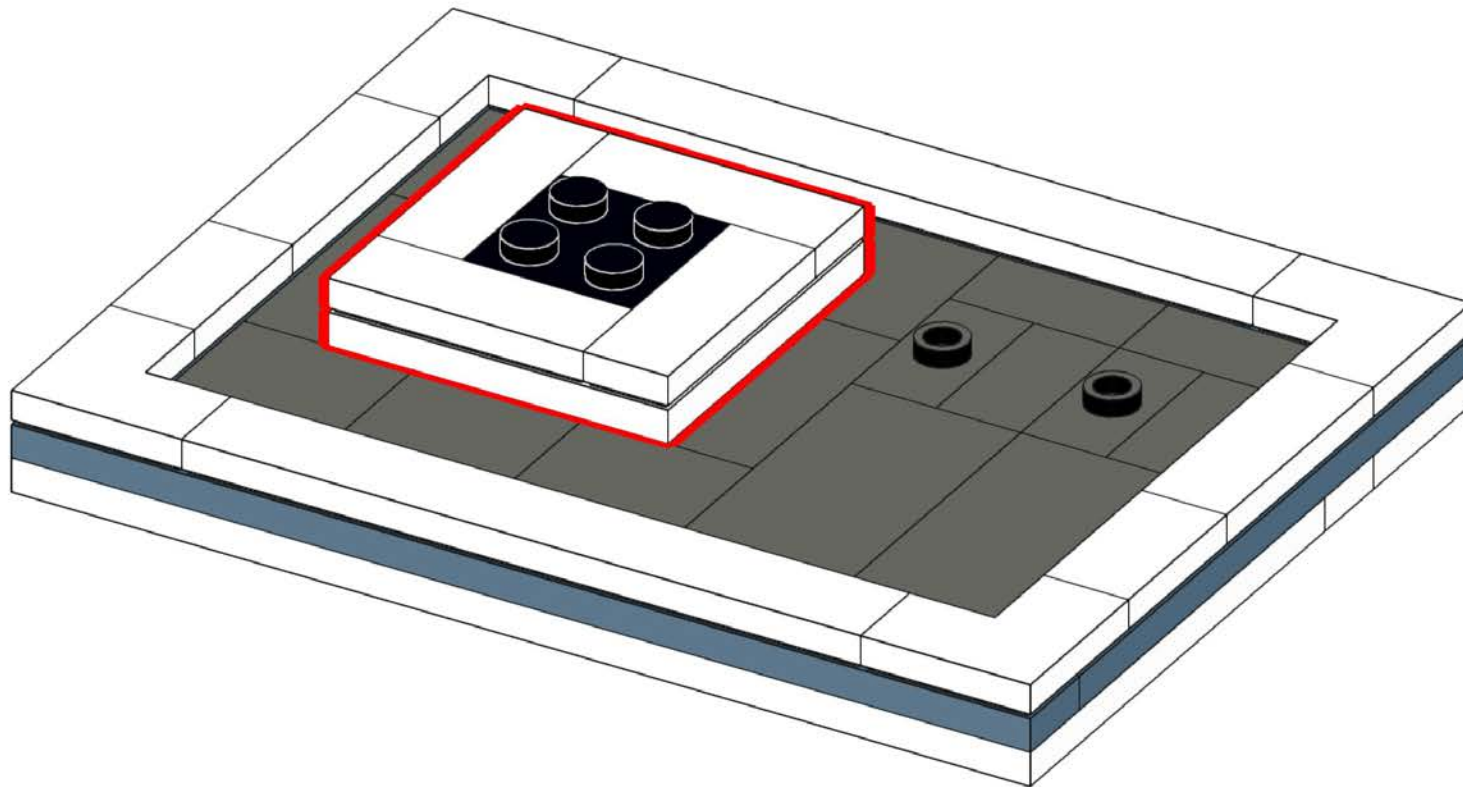
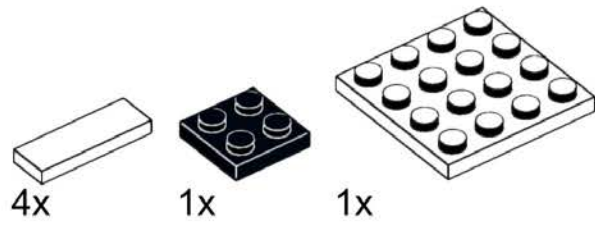



# 807

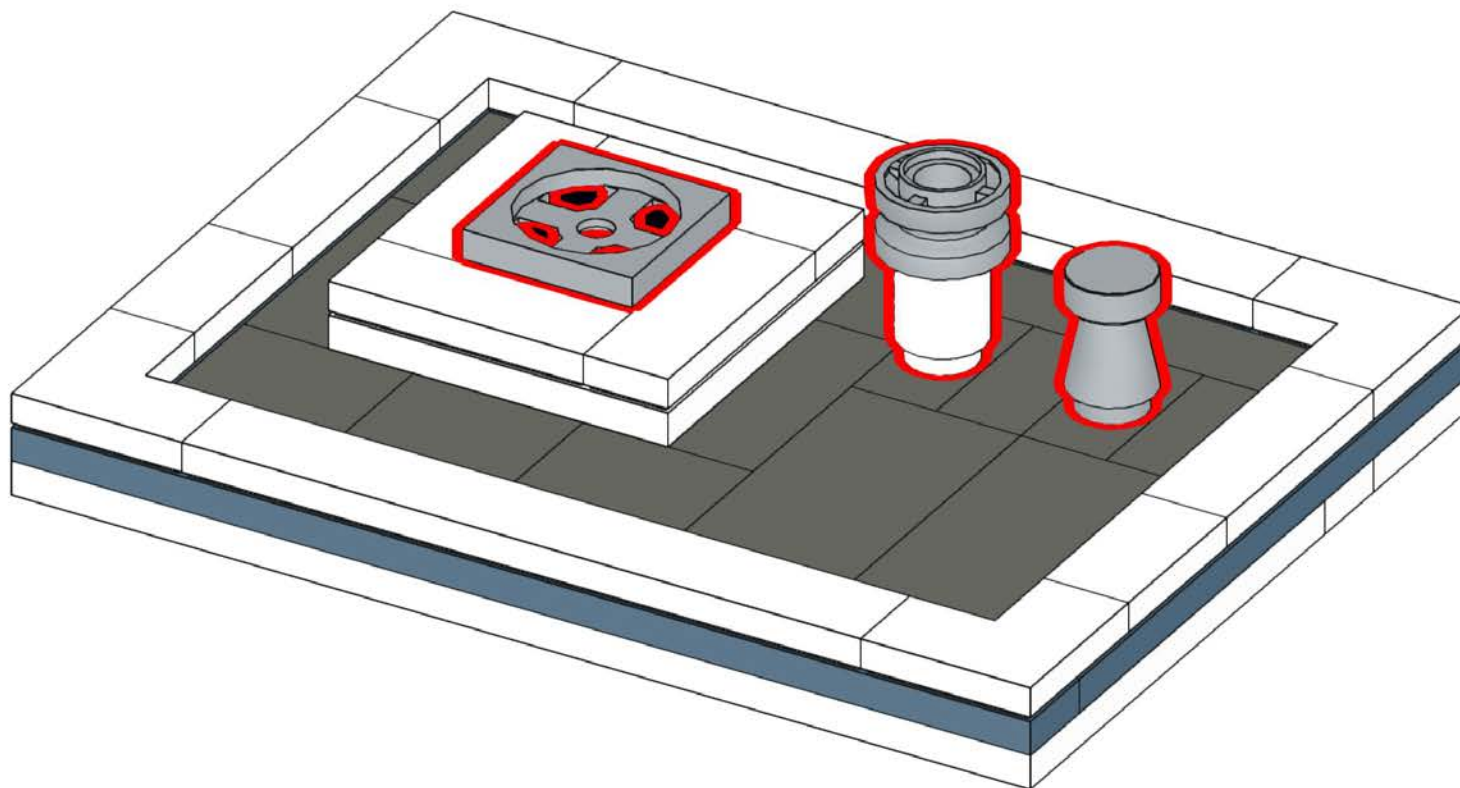
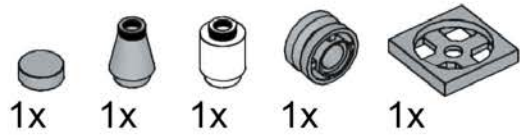

# 808

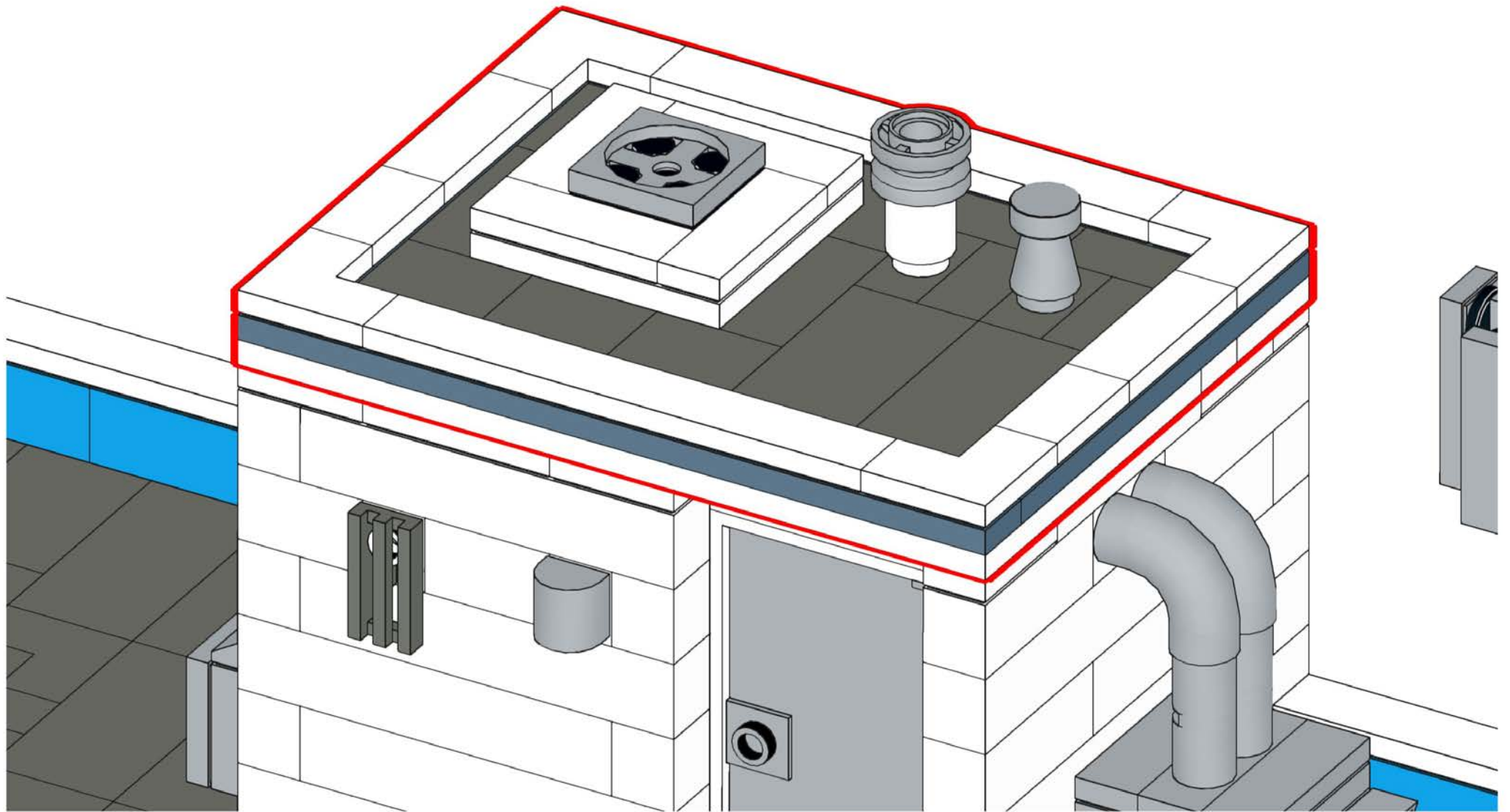

809

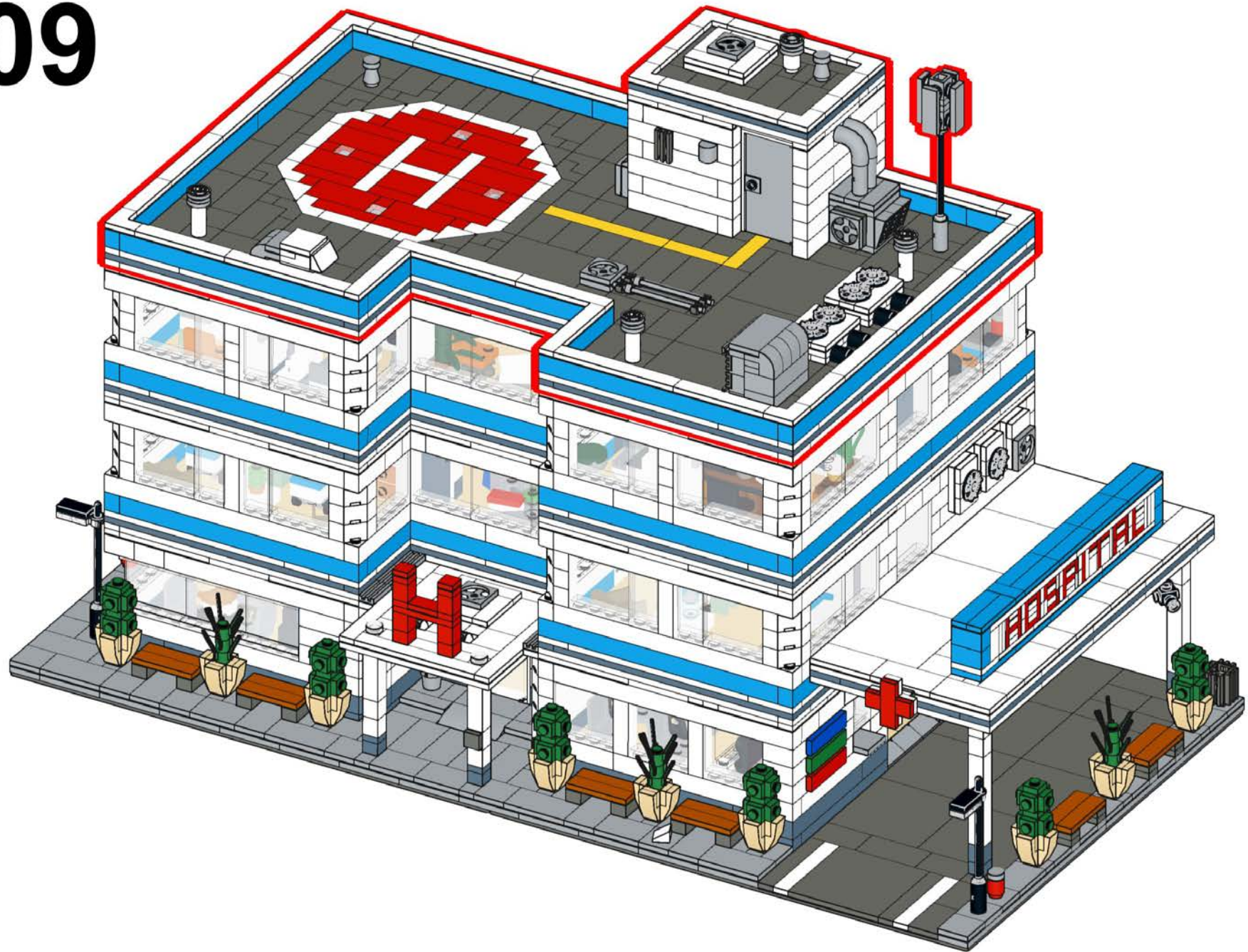

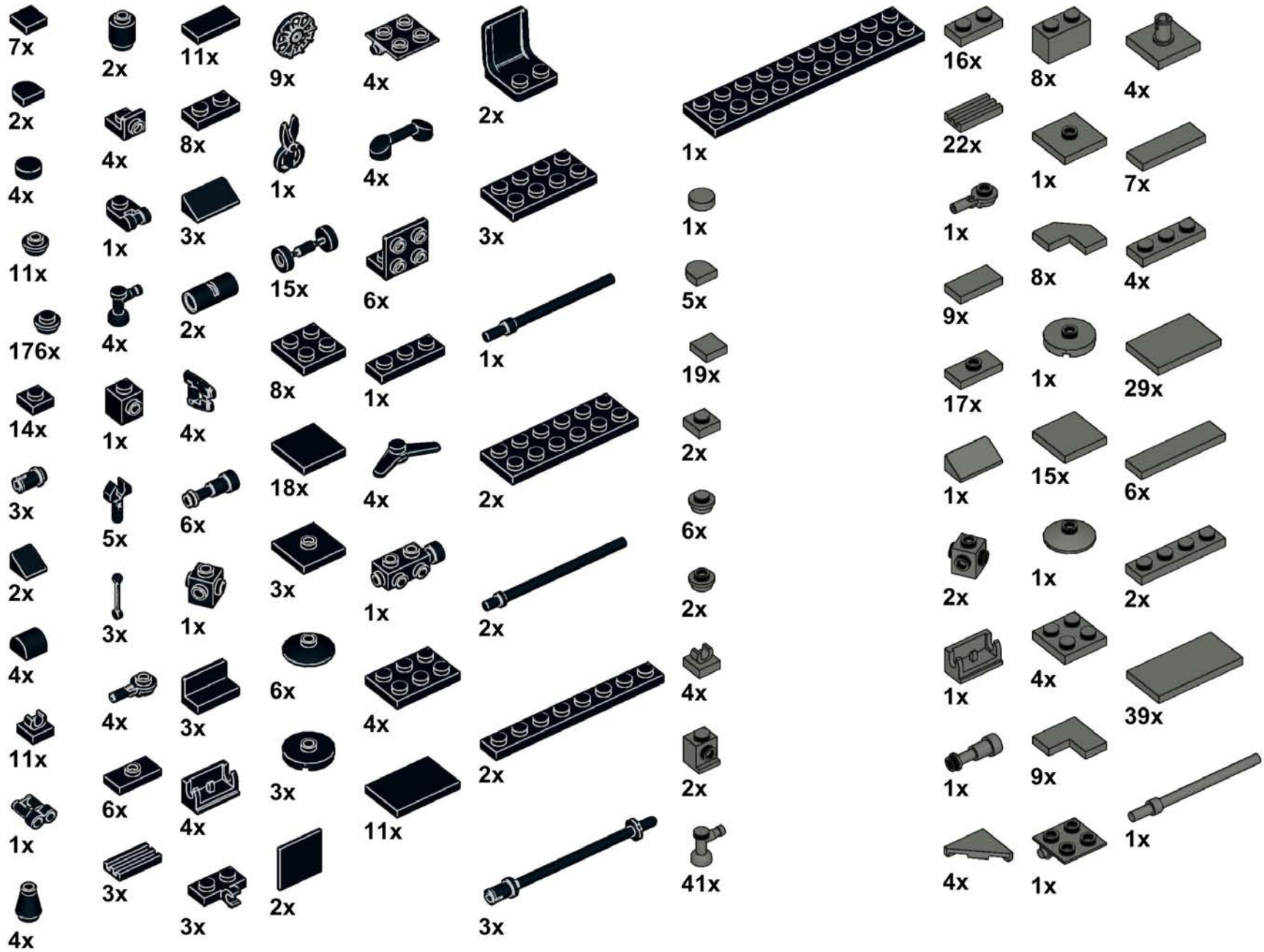



1x



2x

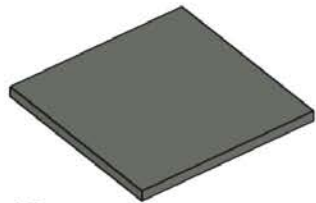

12x

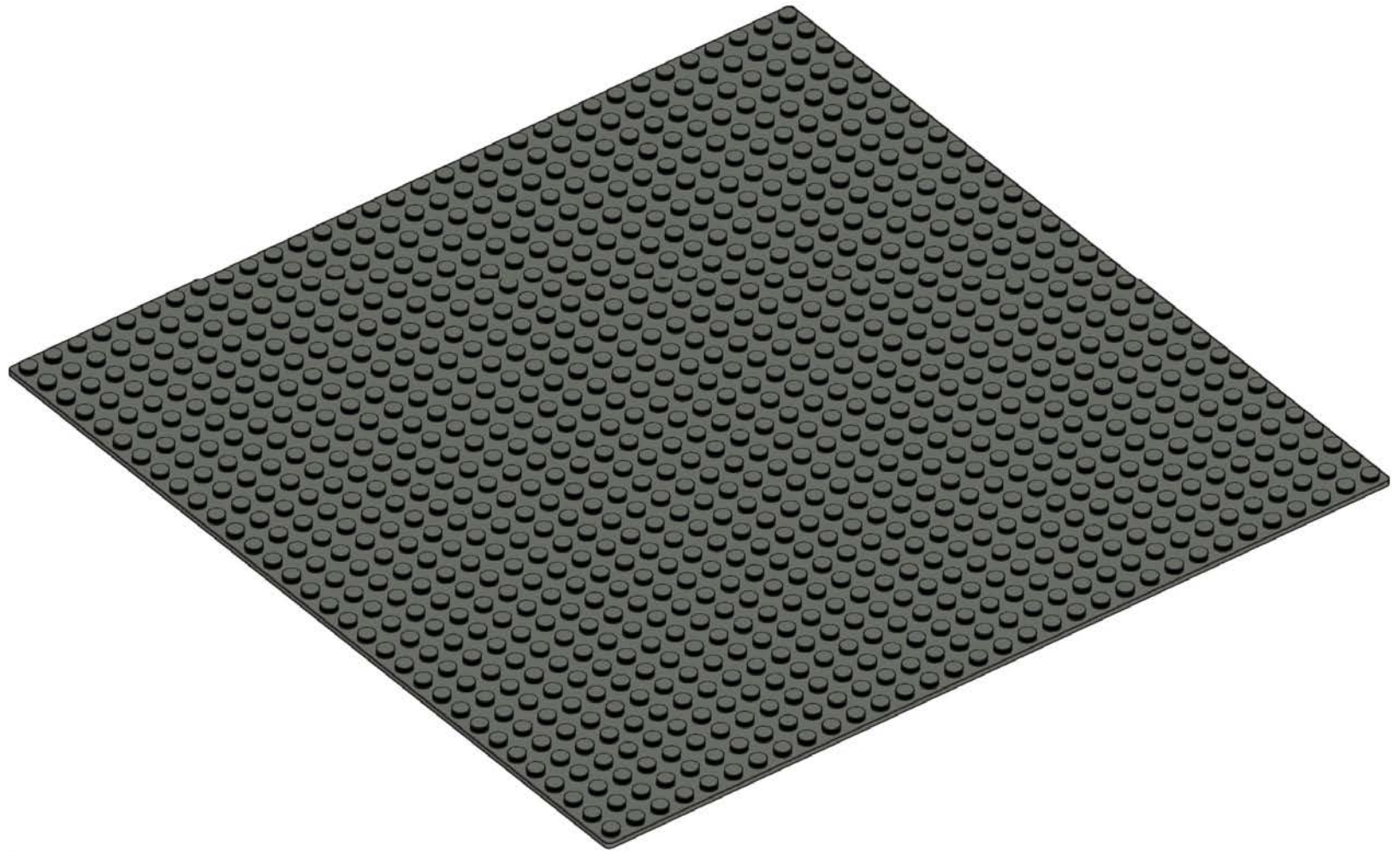

2x



1x



2x

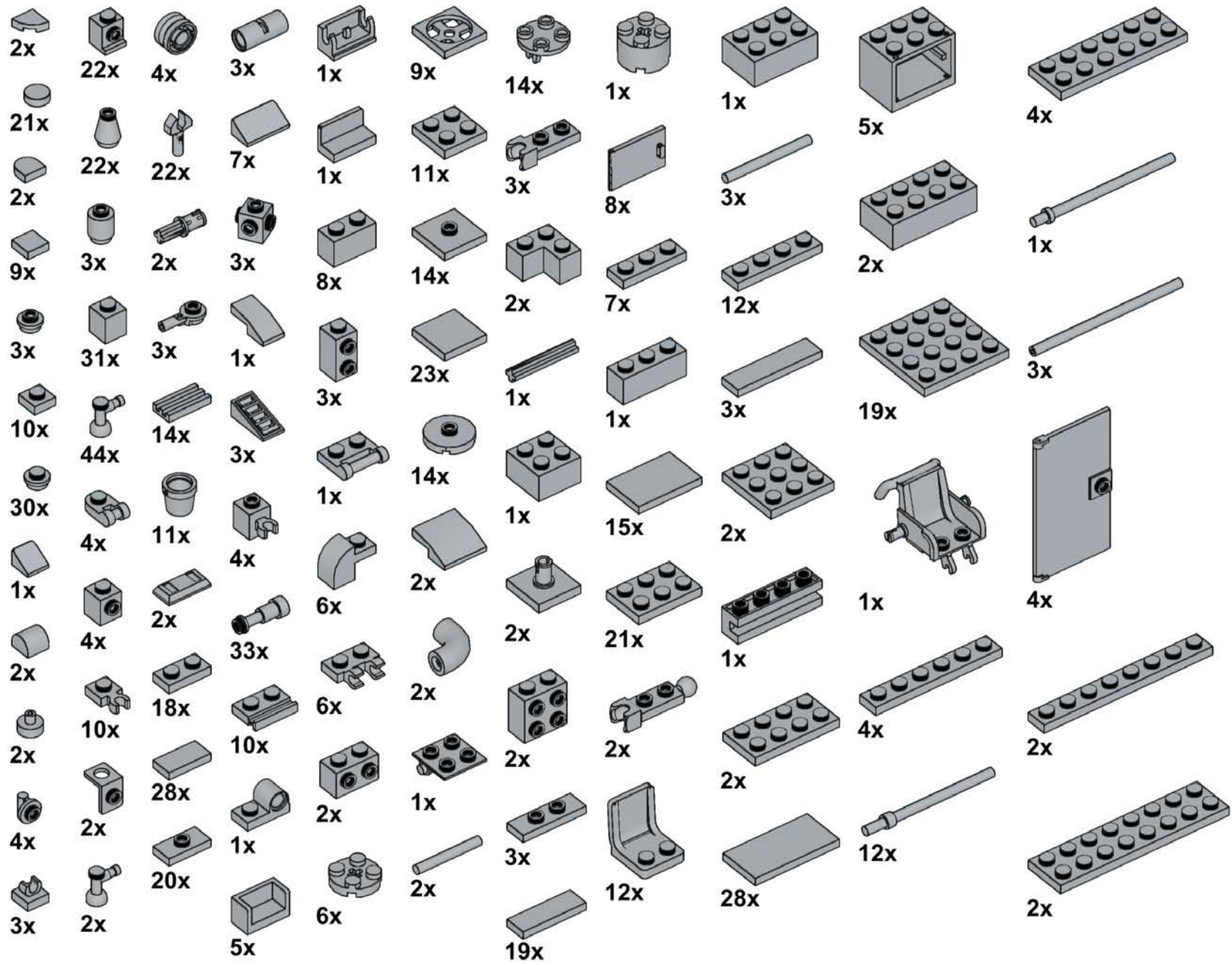

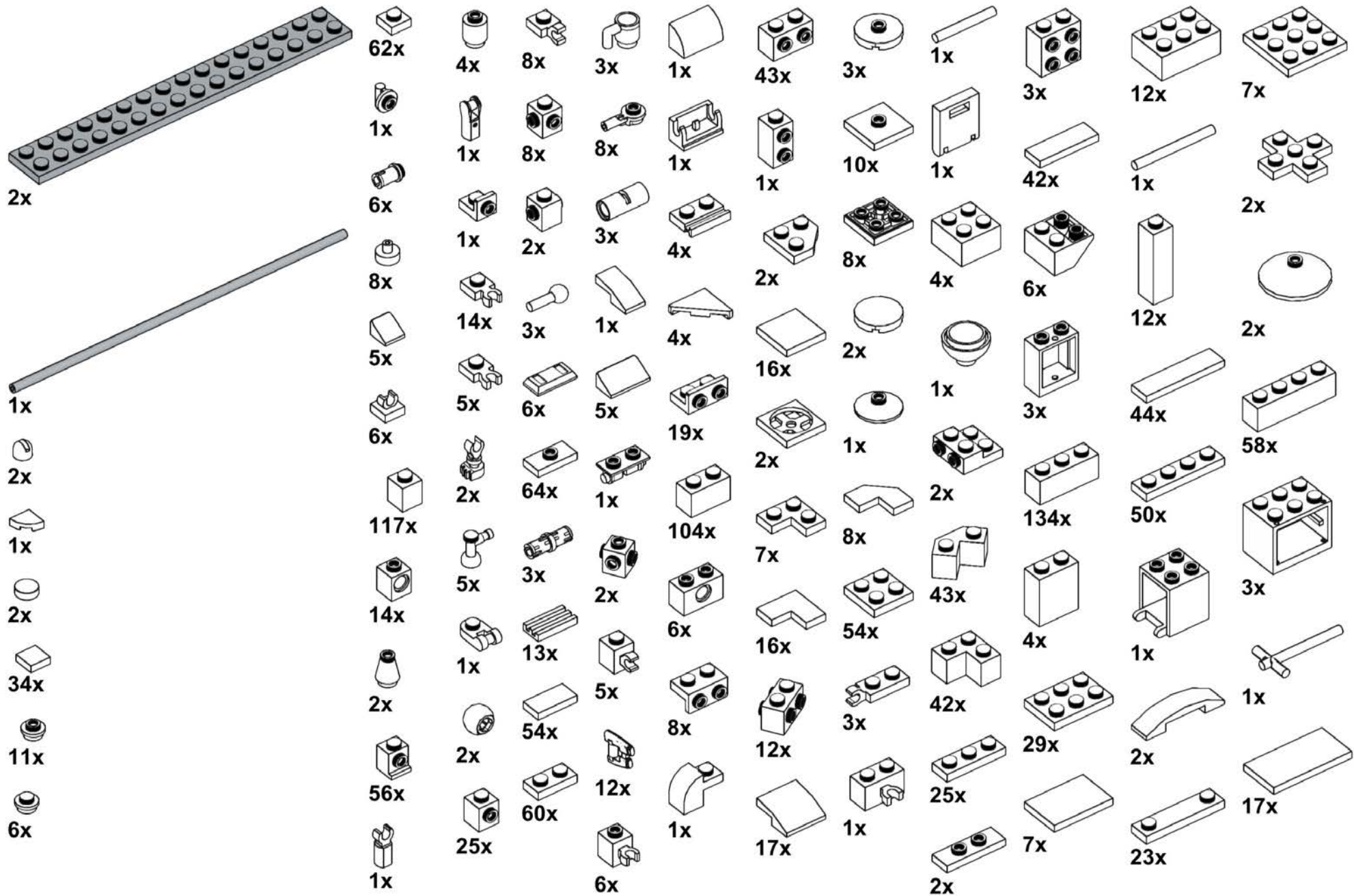

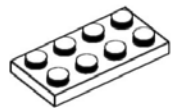

33x



4x

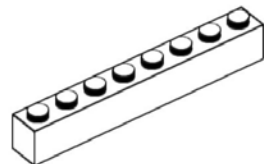

47x

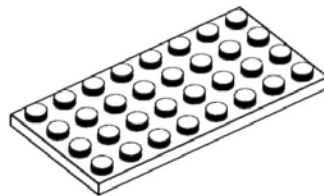

1x

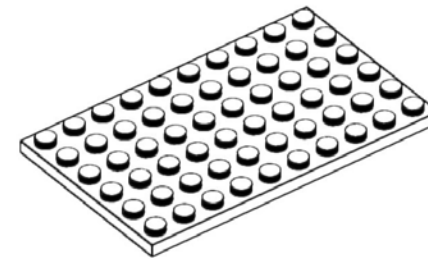

4x

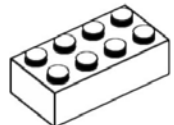

3x

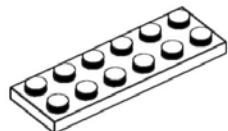

18x

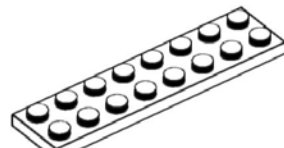

13x

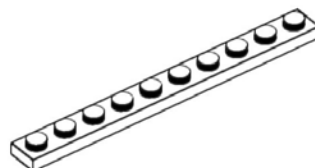

9x

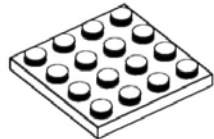

6x

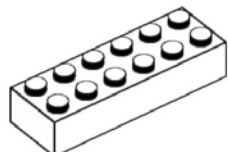

1x

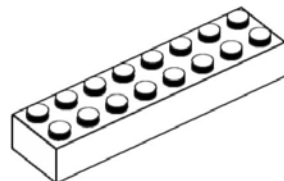

2x

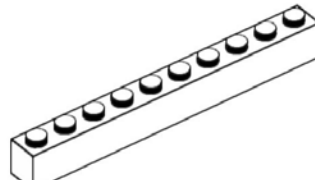

45x

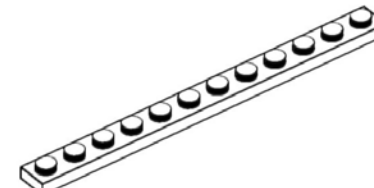

24x

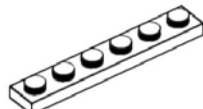

15x

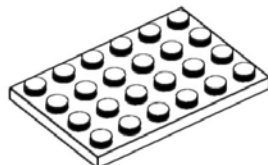

1x

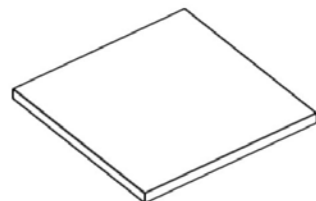

4x

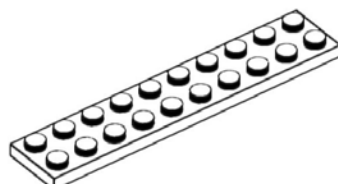

12x

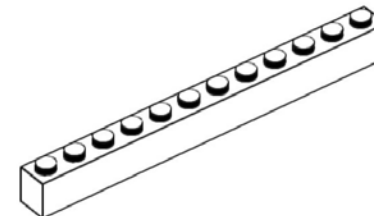

27x



67x

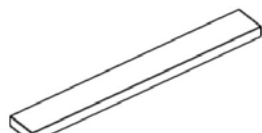

36x

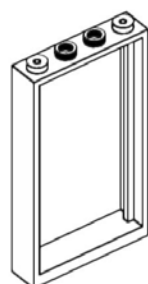

22x

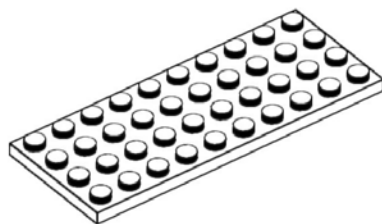

3x

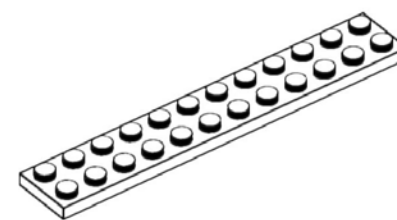

4x

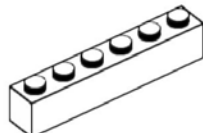

51x

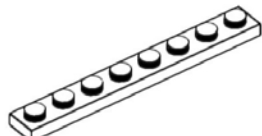

19x



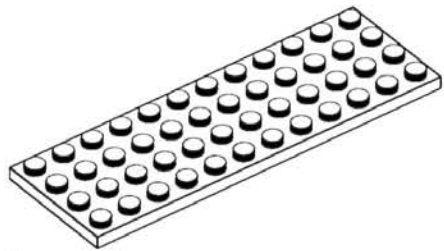

1x

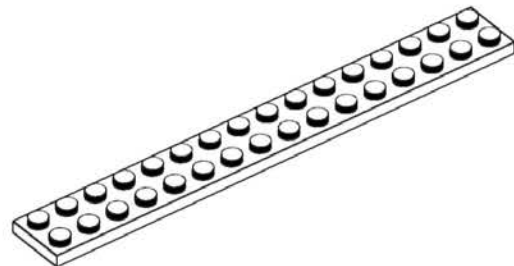

50x

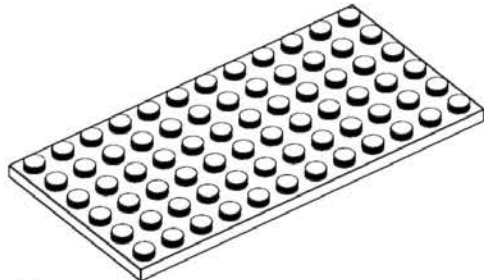

13x

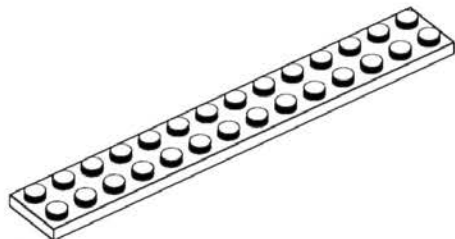

2x

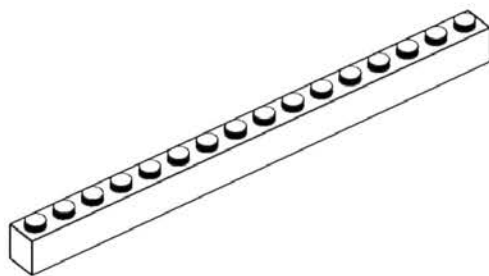

18x

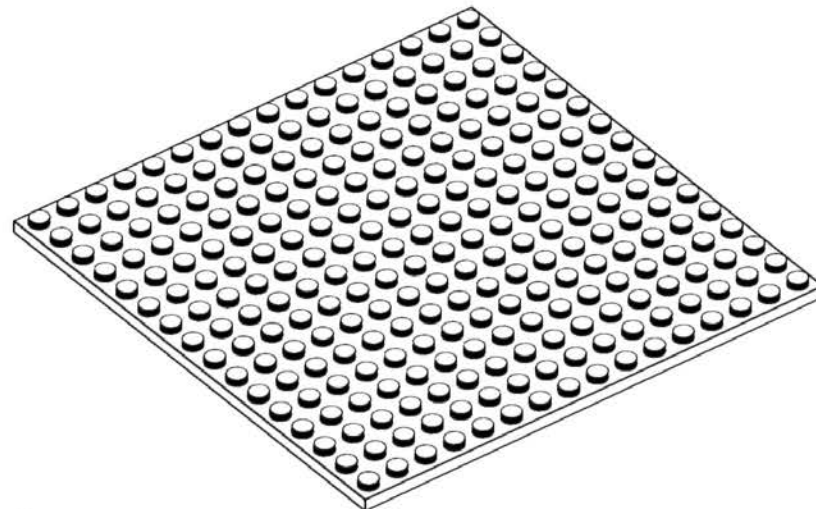

2x



2x



5x



24x



1x



15x



1x



1x



6x



4x



1x



1x



10x



11x



3x



1x



1x



6x



1x



2x



1x



8x



8x



1x



1x



3x



4x



3x



6x



7x



2x



2x



2x



2x



6x





4x



10x



2x

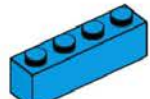

1x



2x



3x



3x



6x



1x



6x

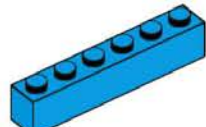

8x



8x



1x



3x

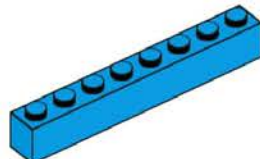

1x



1x

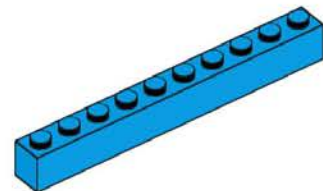

6x

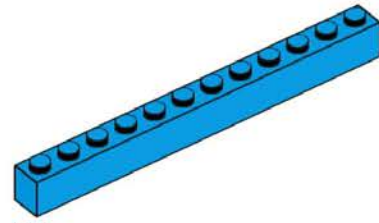

8x

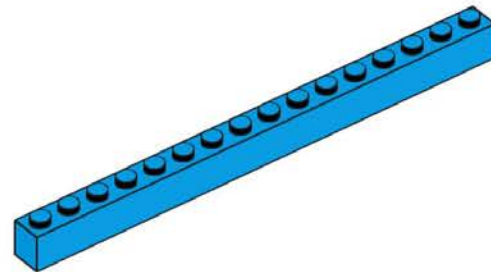

15x



3x



1x



9x



3x



6x



11x



8x



1x



2x



2x



1x



12x



1x



17x



5x



12x



1x



10x



1x



1x



7x

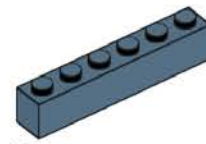

8x



17x



6x



6x



11x

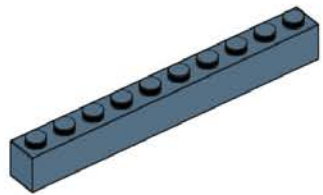

14x

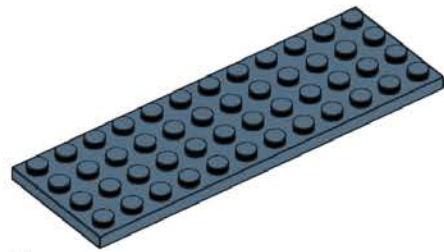

7x

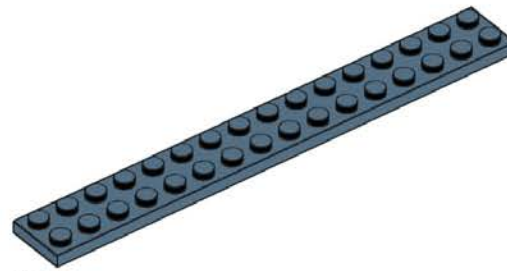

2x



15x

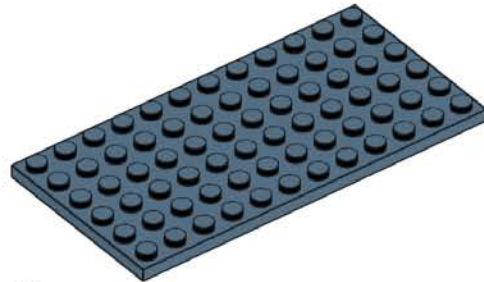

12x

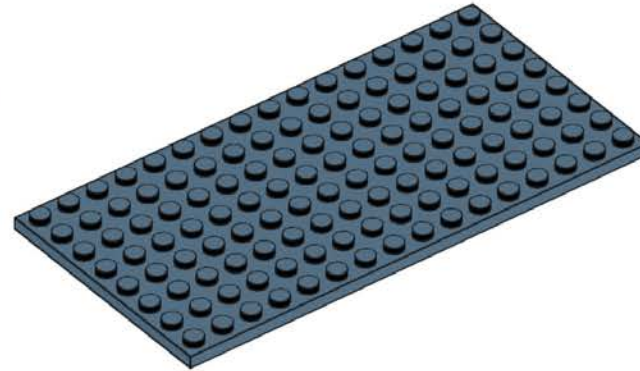

3x

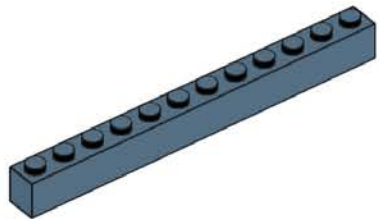

5x

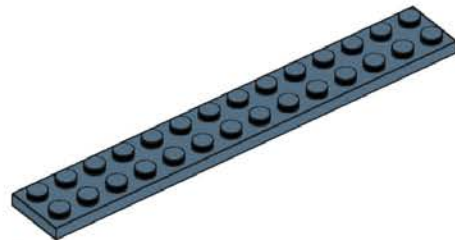

2x

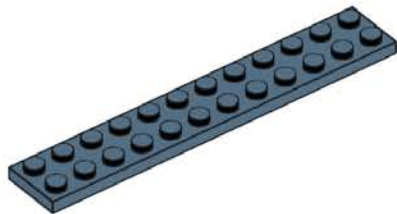

2x

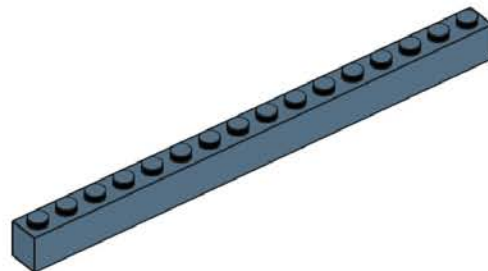

8x

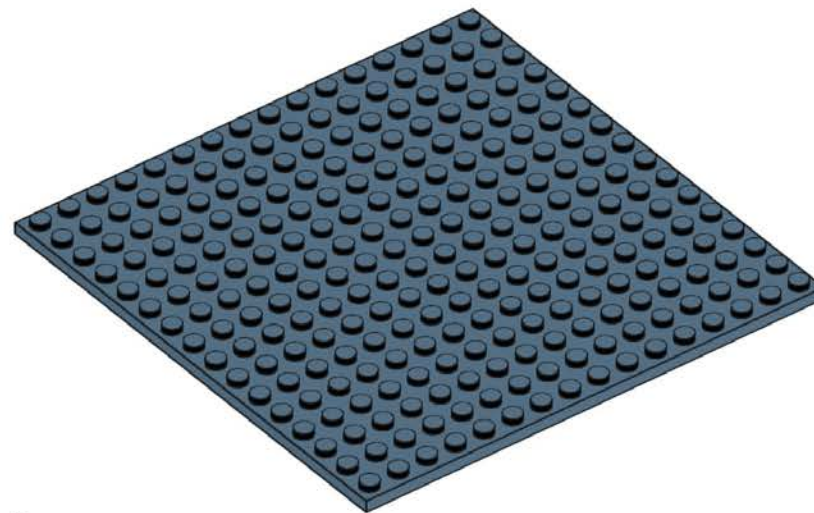

6x

